

Estudio para análisis de falla EAF 128/2016

"Desconexión forzada de barra 12 kV de S/E Florida"

Fecha de Emisión: 06-05-2016

1. Descripción pormenorizada de la perturbación

a. Fecha y Hora de la Falla

Fecha	16-04-2016
Hora	19:16:00

b. Estimación de consumos desconectados

Consumos desconectados (MW)	000007.40
-----------------------------	-----------

c. Origen de la falla:

De acuerdo con lo informado por Eléctrica Puntilla S.A., la desconexión forzada de la barra de 12 kV de S/E Florida se debió a la operación de las protecciones del transformador 110/12 kV de S/E Florida, ante una falla de origen interno ocurrida en el Switchgear de 12 kV de central Florida 1

c.1 Fenómeno físico:

OTR2: Origen no determinado (trip de interruptor)

c.2 Elemento donde se produjo la falla:

PR2: Celdas

c.3 Fenómeno eléctrico:

PR51N: Protección de sobrecorriente temporizada residual

c.4 Modo (comportamiento de interruptores principales):

13: Opera según lo esperado

d. Comuna donde se presenta la falla:

13110: La Florida

2. Descripción del equipamiento afectado

a. Sistema de Generación

Central	Unidad	Pérdida de Generación (MW)	H. Desconexión	H. Normalización
El Rincón	1	000000.21	19:16	21:00
Florida II	1	000006.50	19:16	23:38
Florida III	1	000001.10	19:16	23:38
Florida III	2	000001.10	19:16	23:38

Total : 8.91 MW

b. Sistema de Transmisión

Elemento Afectado	Tramo	Hora Desc.	Hora Norm.
S/E Florida	Transformador 110/12 kV	19:16:00	20:35:00
S/E Florida	Barra 12 kV	19:16:00	20:35:00

c. Consumos

Sub-Estación	Pérdida de Consumo (MW)	% consumo pre-falla	Hora Desc.	Hora Norm.
S/E Florida (SCM)	000004.70	000000.082	19:16	19:29
S/E Florida (SCM)	000002.70	000000.047	19:16	19:29

Total : 7.4 MW 0.129 %

- Horas y montos señalados corresponden a lo informado por Eléctrica Puntilla S.A.

3. Estimación de la energía no suministrada

Sub-Estación	Empresa	Tipo de Cliente	Pérdida de Consumo (MW)	Tiempo Desc. (Hr)	ENS (MWhr)
S/E Florida (SCM)	CHILECTRA	Regulado	000004.70	00000.22	0000000001.0
S/E Florida (SCM)	CHILECTRA	Regulado	000002.70	00000.22	0000000000.6

Clientes Regulados : 1.6 MWhr

Clientes Libres : 0.0 MWhr

Total : 1.6 MWhr

- Horas y montos señalados corresponden a lo informado por Eléctrica Puntilla S.A.

4. Descripción de las configuraciones en los momentos previo y posterior a la falla

Demanda del sistema previo a la falla: 005718.88 MW

Regulación de Frecuencia

Unidad reguladora: Colbún U1

Operación Programada

En anexo N° 1 se adjunta el detalle de la generación programada para el día 16 de Abril de 2016

Operación Real

En anexo N° 2 se adjunta el detalle de la generación real del día 16 de Abril de 2016

Movimiento de centrales e informe de novedades relevantes del CDC

En anexo N° 3 se presenta el detalle del movimiento de centrales e informe de novedades relevantes del CDC para el día 16 de Abril de 2016

Mantenimientos

En anexo N° 4 se presenta el detalle de los mantenimientos programados y forzados para el día 16 de Abril de 2016

Estado y configuración previo a la falla

Las instalaciones de transmisión se encontraban en servicio normal en los momentos previos a la desconexión forzada

Otros antecedentes relevantes

De acuerdo con lo informado por Eléctrica Puntilla S.A.:

No se cuenta con registro del evento en la protección 7UT (del transformador 110/12 kV de S/E Florida), ya que este fue borrado inadvertidamente al extraer la data del relé

Acciones correctivas a largo plazo

Eléctrica Puntilla S.A. no ha indicado acciones correctivas a largo plazo

Acciones correctivas a corto plazo

Eléctrica Puntilla S.A. indica que "se recomienda aumentar el retardo de operación e insensibilidad de la función de sobrecorriente residual de 110 kV, residente en la protección diferencial de transformador de Florida, dado que una falla pasante y desequilibrada, puede hacer operar la protección con el actual ajuste de protección"

Diagrama simplificado de las instalaciones previo a la falla

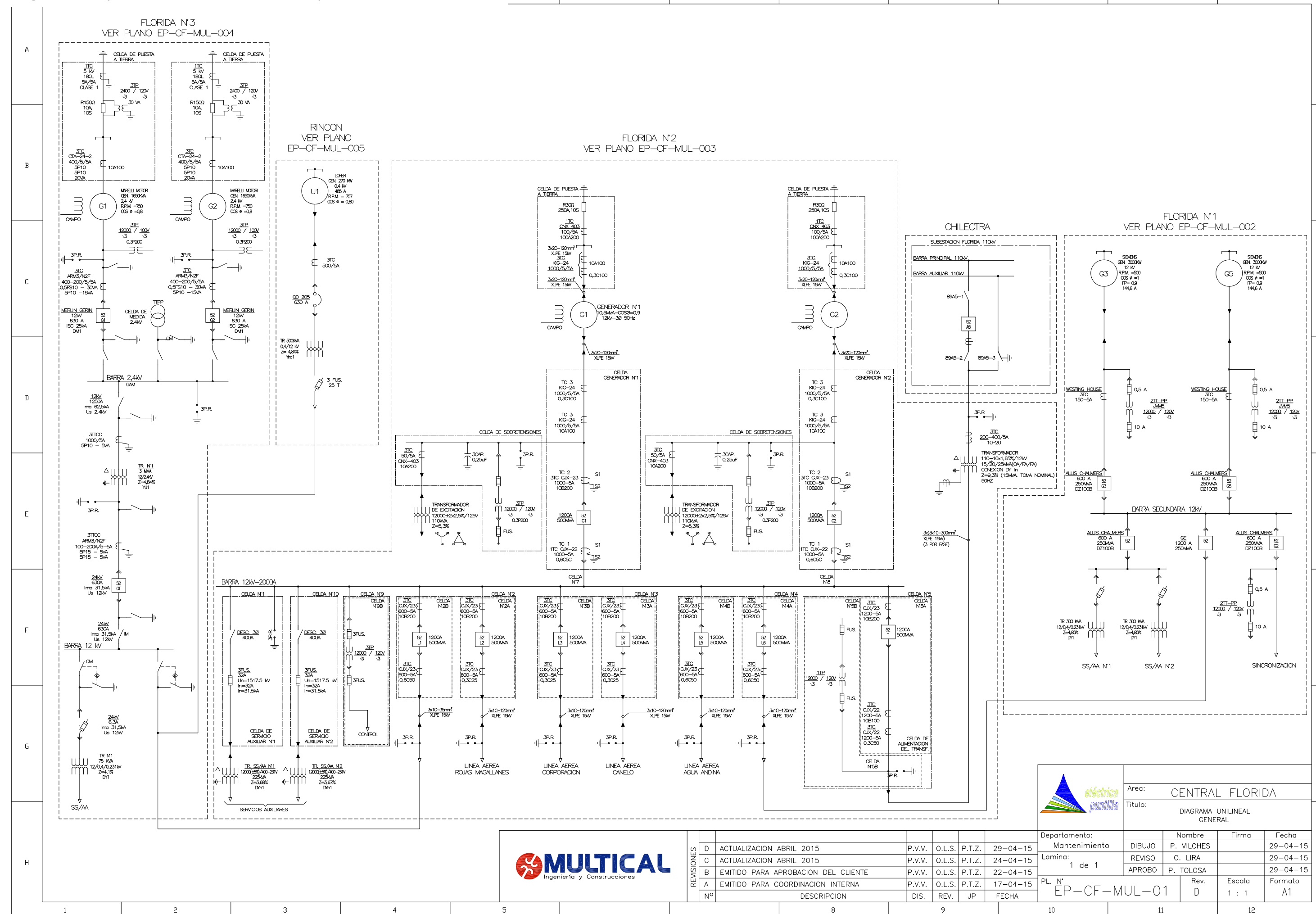

Area: **CENTRAL FLORIDA**

Título: **DIAGRAMA UNILINEAL GENERAL**

Departamento:	Nombre	Firma	Fecha
Mantenimiento	DIBUJO	P. VILCHES	29-04-15
Lamina: 1 de 1	REVISO	O. LIRA	29-04-15
	APROBO	P. TOLOSA	29-04-15

PL. N°	Rev.	Escala	Formato
EP-CF-MUL-01	D	1 : 1	A1



REVISIONES	DIS.	REV.	JP	FECHA	
D	ACTUALIZACION ABRIL 2015	P.V.V.	O.L.S.	P.T.Z.	29-04-15
C	ACTUALIZACION ABRIL 2015	P.V.V.	O.L.S.	P.T.Z.	24-04-15
B	EMITIDO PARA APROBACION DEL CLIENTE	P.V.V.	O.L.S.	P.T.Z.	22-04-15
A	EMITIDO PARA COORDINACION INTERNA	P.V.V.	O.L.S.	P.T.Z.	17-04-15
N°	DESCRIPCION				

5. Cronología de eventos y la descripción de las causas de los eventos

Hora	Evento
19:16:00	Apertura del interruptor del alimentador de central Florida I por operación de protección de sobrecorriente de fase 51
19:16:00	Apertura de los interruptores de 110 kV y 12 kV del transformador 110/12 kV de S/E Florida por operación de su relé maestro por operación de protección de sobrecorriente residual 51N
19:16:00	Salida intempestiva de servicio de unidad N°1 de central Florida II por operación de protección de baja tensión
19:16:00	Salida intempestiva de servicio de unidad N°1 de central Florida III por operación de función de pérdida de excitación
19:16:00	Salida intempestiva de servicio de unidad N°2 de central Florida III
19:16:00	Salida intempestiva de servicio de central El Rincón por operación de protección de sobrecorriente de fase

6. Normalización del servicio

Fecha	Hora	Acción
16-04-2016	19:21:00	Se realiza apertura de los alimentadores Rojas Magallanes y Corporación de S/E Florida
16-04-2016	19:22:00	Se realiza la apertura de los interruptores de los alimentadores de central Florida I, de central Florida III y del alimentador Agua Andinas
16-04-2016	19:29:00	Se recuperan todos los consumos perdidos de S/E Florida
16-04-2016	19:52:00	Chilectra informa a Eléctrica Puntilla que se envió guardia para realización de revisión en S/E Florida
16-04-2016	20:10:00	Comienza inspección de transformador 110/12 kV de S/E Florida
16-04-2016	20:22:00	Chilectra informa a Eléctrica Puntilla que no se encontró anomalía en transformador 110/12 kV por su lado de 110 kV
16-04-2016	20:25:00	Se normaliza relé 86T del transformador 110/12 kV de S/E Florida
16-04-2016	20:26:00	Se realiza prueba de cierre del interruptor de 110 kV del transformador 110/12 kV de S/E Florida, la que resulta exitosa, procediendo a realizar su posterior apertura
16-04-2016	20:34:00	Se realiza cierre del interruptor de 12 kV del transformador 110/12 kV de S/E Florida
16-04-2016	20:35:00	Se realiza cierre del interruptor de 110 kV del transformador 110/12 kV de S/E Florida
16-04-2016	20:45:00	Se realiza cierre del alimentador hacia central Florida III
16-04-2016	21:00:00	Se sincroniza central El Rincón al sistema de forma local
16-04-2016	21:20:00	Se realiza prueba de conexión de la unidad de central Florida 3, conectando por 5 minutos tras los cuales se desconecta. Se realizan 2 intentos infructuosos. Se espera a personal de mantenimiento para revisión de lo ocurrido
16-04-2016	21:24:00	Eléctrica Puntilla toma contacto con personal de Aguas Andinas que indica que la desconexión no afectó de ninguna manera sus dependencias. Se coordina cierre del alimentador Aguas Andinas
16-04-2016	21:45:00	Se realiza cierre del alimentador Aguas Andinas
16-04-2016	21:52:00	Eléctrica Puntilla toma contacto con personal de Aguas Andinas, el cual indica que se normalizará caudal hacia planta de Aguas Andinas
16-04-2016	22:05:00	Eléctrica Puntilla toma contacto con personal de Aguas Andinas, el cual indica que no se realizarán las pruebas debido a que agua en río aún se encuentra turbia
16-04-2016	22:15:00	Llega personal de apoyo a central Florida para realizar limpieza de rejillas
16-04-2016	23:11:00	Eléctrica Puntilla toma contacto con personal de Chilectra, consultando cuándo se normalizarán los alimentadores. Chilectra indica que se normalizarán alrededor de las 02:00 horas del día 18-04-16
16-04-2016	23:38:00	Se normalizan las unidades de central Florida por normalización de canal

- Horas, maniobras y eventos señalados corresponden a lo informado por Eléctrica Puntilla S.A.

7. Análisis de las causas de la falla y de la actuación de los dispositivos de protección y control

De acuerdo con lo informado por Eléctrica Puntilla S.A., la desconexión forzada de la barra de 12 kV de S/E Florida se debió a la operación de las protecciones del transformador 110/12 kV de S/E Florida, ante una falla de origen interno ocurrida en el Switchgear de 12 kV de central Florida 1

De acuerdo con lo informado por Eléctrica Puntilla S.A., alrededor de las 19:16 horas del día 16-04-2016 se registra la apertura del interruptor del alimentador de central Florida I, la desconexión intempestiva del transformador 110/12 kV de S/E Florida, junto con la salida de servicio de central Florida II (unidad 1), central Florida III (unidades 1 y 2) y de central El Rincón. La desconexión de las instalaciones mencionadas se origina por la operación de protecciones eléctricas ante una falla de origen interno ocurrida en el Switchgear de 12 kV de central Florida 1, presentándose a continuación los registros provistos de las protecciones operadas.

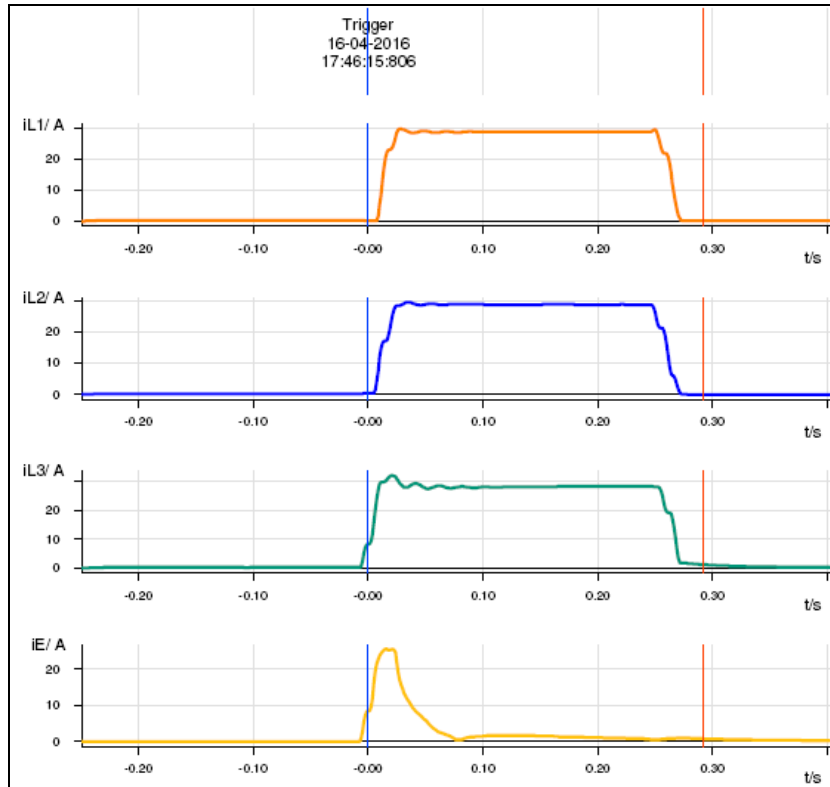

Registro oscilográfico transformador 110/12 kV S/E Florida (relé 7SJ62)

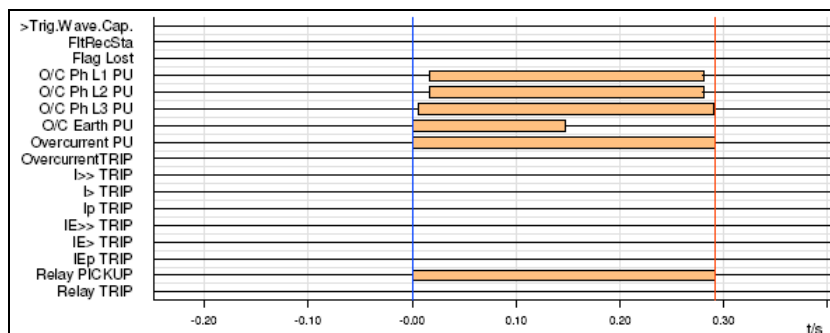

Registro de señales digitales transformador 110/12 kV S/E Florida (relé 7SJ62)

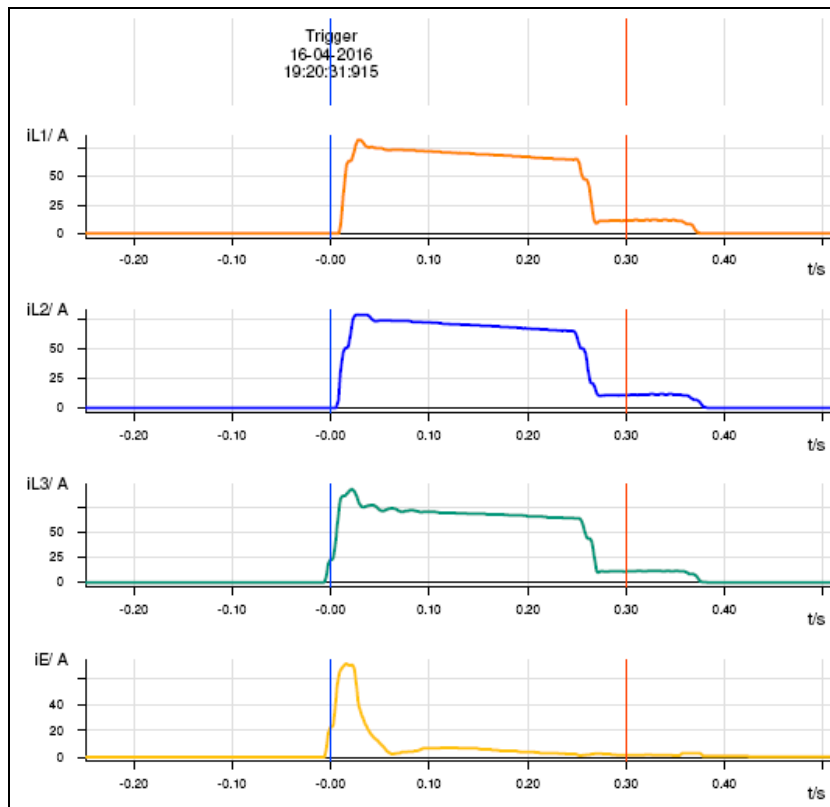

Registro oscilográfico alimentador central Florida I

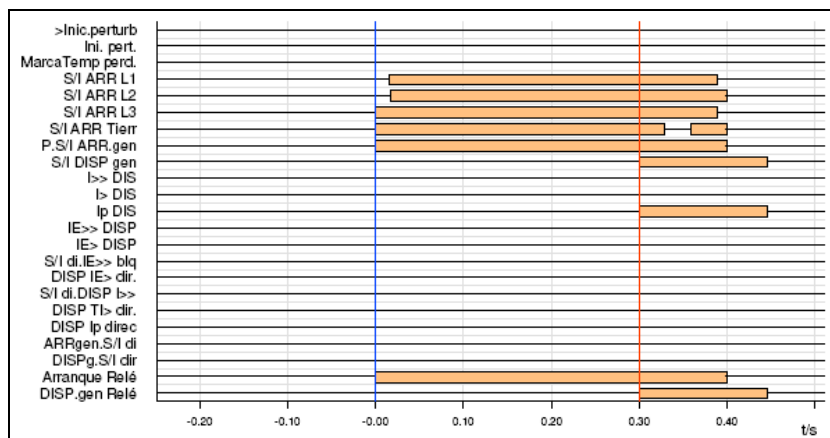

Registro de señales digitales alimentador central Florida I

En las dos oscilografías previas se aprecia la presencia de una falla de característica trifásica con presencia de corriente residual en un principio, detectada por las protecciones del transformador 110/12 kV de S/E Florida (relé 7SJ62) y del alimentador de central Florida I. Respecto de la falla ocurrida y del desempeño de las protecciones eléctricas, Eléctrica Puntilla S.A. indica lo siguiente:

- La desconexión de la barra de 12 kV de Central Florida 2 se debió a la operación de las protecciones del transformador de poder 110/12 kV, debido a ocurrencia de una falla de origen interno, en el Switchgear de 12 kV en Central Florida 1.
- Previa a la condición de falla, las Centrales Florida 1, Centrales Florida 2, Centrales Florida 3 y Central Rincón se encontraban operando en forma normal, cuando a las 19:16 hrs del día sábado 16-04-2016 ocurre una falla en el switchgear de la Central Florida 1, siendo del tipo de falla trifásica (según lo observado en las oscilografías).
- La protección 7SJ del alimentador Florida 1, que ordena el desenganche del interruptor correspondiente, es lo que finalmente determina la aislación de la falla ocurrida en el Switchgear de Central Florida 1 en 12 kV.

- La protección 7SJ del alimentador Florida 1, ordena el desenganche del interruptor correspondiente, que finalmente determina la aislación de la falla ocurrida en el Switchgear de Central Florida 1 en 12 kV.
- A su vez la falla fue detectada por las protecciones asociadas al transformador 110/12kV de la Central Florida 2, donde la protección 7SJ del transformador tuvo arranques por sobrecorriente de fase, pero no tuvo orden de desenganche, ya que la protección cuenta con tiempo de paso ante fallas aguas debajo de ésta.
- En cambio la protección 7UT del transformador, tuvo operación de sus funciones de protección con salida disparando sobre el relé maestro 86T, que ordena el desenganche simultáneo de los interruptores de 12 kV y 110 kV del transformador de poder N° 1 de S/E Florida. Lamentablemente, no se cuenta con registro del evento en la protección 7UT, ya que éste fue borrado inadvertidamente al extraer la data del relé.
- De lo anterior, se desprende que el disparos de la protección 7UT del transformador, el día Sábado 16-04-2016, se realiza debido a la operación de la función 51N (3I₀).
- El origen de la falla, se asocia a algún defecto aún no identificado, ubicado en el Switchgear de Central Florida 1, que habría producido un cortocircuito trifásico, alcanzando una magnitud cercana a los 7,7 kA, valor que se obtiene de la oscilografía registrada por el relé 7SJ del alimentador Florida 1.
- La secuencia de operación de protecciones en Central Florida 2, es la siguiente:
 1. En protección Siemens 7SJ62 del alimentador de Florida 1, la función 51 de fase (sobrecorriente temporizada), dispara a los 300 ms y desengancha al interruptor cuya extinción de corriente ocurre a los 400 ms.
 2. En protección 7UT61 del transformador de Florida 110/12 kV, la función 51N (3xI₀) del lado de 110 kV genera un disparo cuyo tiempo específico se desconoce. Debido a que aún no se había extinguido la corriente en el interruptor Florida 1, el disparo del relé 7UT61 por 3I₀ activa el relé Maestro 86T que ordena el desenganche de los interruptores de 110 y 12 kV, sin embargo, la extinción de la corriente de falla la dio el interruptor Florida 1.
 3. La función 51 de la protección Siemens 7SJ62, de respaldo del transformador de Florida 110/12 kV, no disparó, dado que tiene tiempo de paso (+300 ms) ante fallas al interior de la Central Florida 2.
 4. La función 51 de la protección Siemens 7SJ62, del alimentador de Florida 3, no disparó, dado que tiene tiempo de paso (+300 ms) para falla hacia el lado de la barra de 12 kV de Florida 2.

A partir de los antecedentes anteriores, se evidencia la existencia de una descoordinación entre las protecciones del transformador 110/12 kV de S/E Florida (relé 7UT61) y las protecciones del alimentador de la central Florida I, la cual no puede establecerse claramente debido a la falta de registros del relé 7UT61 operado.

Además, tras la apertura de los mencionados interruptores los consumos de S/E Florida quedan abastecidos transitoriamente mediante las centrales Florida II, Florida III y Rincón, las cuales se desconectan por operación de sus protecciones, cuyos registros se presentan a continuación.

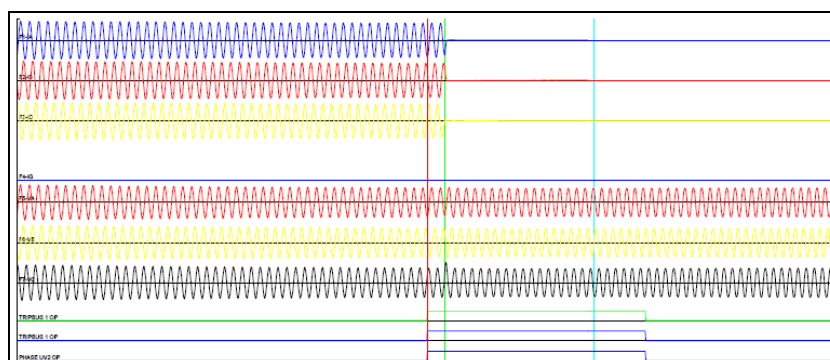

Registro oscilográfico unidad 1 central Florida II

Cursor 1 = 1566.12 ms			
Cursor 2 = 1169.42 ms			
Delta = -396.71 ms			
Trigger Date = 16/04/2016			
Trigger Time = 19:18:34.756845			
AXIS	CURSOR 1	CURSOR 2	DELTA
F1-IA	0.00A	-386.73A	-386.73A
F2-IB	-1.95A	310.56A	312.51A
F3-IC	0.00A	11.72A	11.72A
F4-IG	0.00A	-0.07A	-0.07A
F5-VA	6152.33V	-5823.96V	-11976.29V
F6-VB	-463.87V	3643.79V	4107.66V
F7-VC	-5858.14V	7873.51V	13731.65V
TRIPBUS 1 OP	Low	Low	-
TRIPBUS 1 OP	Low	Low	-
PHASE UV2 OP	High	High	-

Señalización de protecciones operadas unidad 1 central Florida II

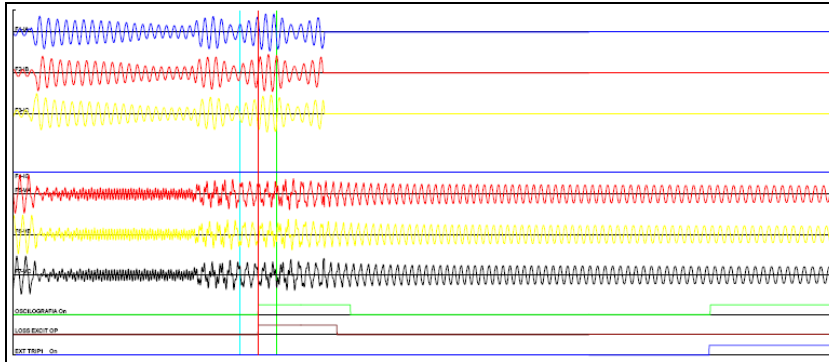

Registro oscilográfico unidad 1 central Florida III

Cursor 1 = 503.59 ms			
Cursor 2 = 583.14 ms			
Delta = 79.56 ms			
Trigger Date = 16/04/2016			
Trigger Time = 19:18:31.049798			
AXIS	CURSOR 1	CURSOR 2	DELTA
F1-IA	849.25A	-439.86A	-1289.11A
F2-IB	-284.39A	1826.63A	2111.02A
F3-IC	-574.24A	-1390.68A	-816.44A
F4-IG	-0.00A	0.00A	0.00A
F5-VA	1278.51V	450.29V	-828.22V
F6-VB	-888.86V	-773.14V	115.72V
F7-VC	538.48V	-1083.98V	-1622.46V
OSCILOGRAFIA On	Low	Low	-
LOSS EXCIT OP	Low	Low	-
EXT TRIP1 On	Low	Low	-

Señalización de protecciones operadas unidad 1 central Florida III

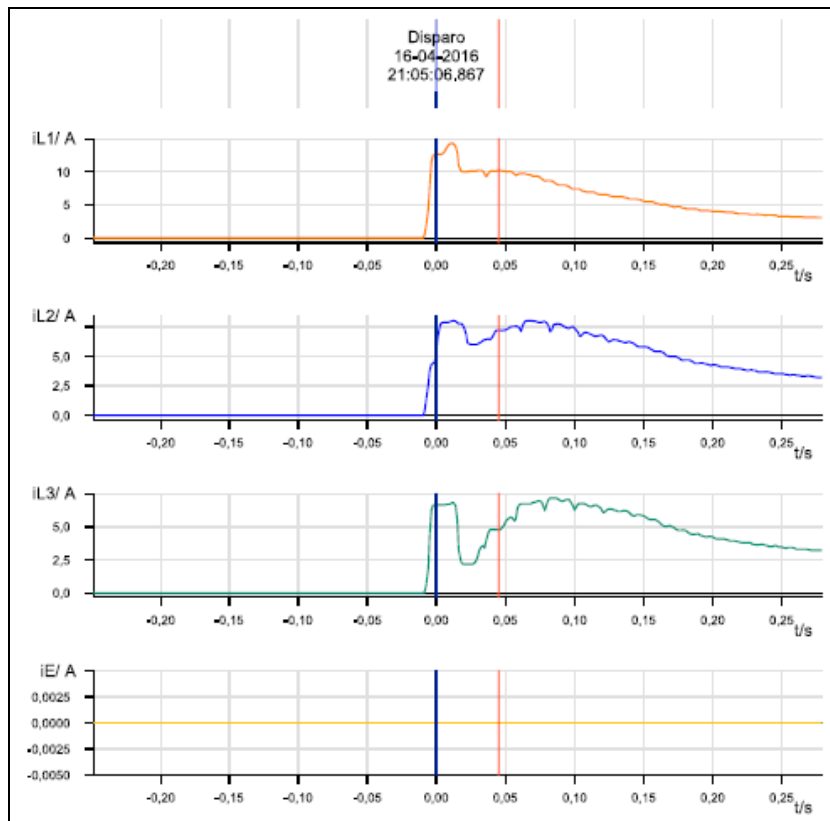

Registro oscilográfico central El Rincón

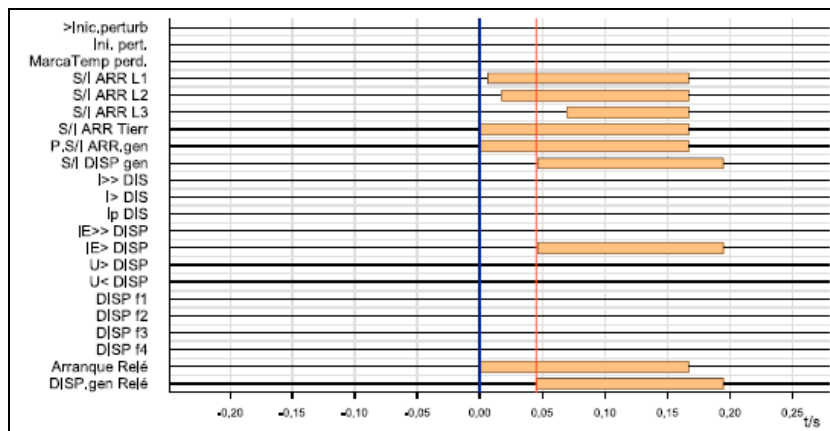

Registro de señales digitales central El Rincón

Respecto del desempeño de estas protecciones eléctricas, Eléctrica Puntilla S.A. indica lo siguiente:

- *Unidad 1 de Central Florida 2, se desconecta del sistema por disparo de función de bajo voltaje (UV), residente en la protección G-30.*
- *Unidad 1 de Central Florida 3, se desconectan del sistema por disparo de la función de pérdida de excitación, residente en protección G-30.*
- *Unidad de Generación El Rincón, se desconecta del sistema por operación de protección de sobrecorriente, Siemens 7SJ62.*

8. Detalle de toda la información utilizada en la evaluación de la falla

- Detalle de la generación programada para el día 16 de abril de 2016 (Anexo N°1)
- Detalle de la generación real del día 16 de abril de 2016 (Anexo N°2)
- Detalle del Movimiento de Centrales e Informe de Novedades Relevantes del CDC correspondientes al día 16 de abril de 2016 (Anexo N°3)
- Detalle de los mantenimientos programados y forzados para el día 16 de abril de 2016 (Anexo N°4)
- Informes de fallas de instalaciones ingresados en el sistema CDEC por Eléctrica Puntilla S.A. (Anexo N°5)
- Otros antecedentes aportados por Eléctrica Puntilla S.A. (Anexo N°6)

9. Análisis de las actuaciones de protecciones

9.1 Pronunciamiento CDEC y Propiedad

La desconexión forzada de la barra de 12 kV de S/E Florida se debió a la operación de las protecciones del transformador 110/12 kV de S/E Florida, ante una falla de origen interno ocurrida en el Switchgear de 12 kV de central Florida 1

La propiedad de la instalación afectada corresponde a Eléctrica Puntilla S.A.

9.2 Desempeño Protecciones Eléctricas

De acuerdo con los antecedentes proporcionados por Eléctrica Puntilla S.A.:

- Se presume correcta operación de la protección de sobrecorriente de fase 51 del alimentador de central Florida I
- Se concluye incorrecta operación de la protección de sobrecorriente residual 51N (relé 7UT61) del transformador 110/12 kV de S/E Florida
- Se presume correcta operación de la protección bajo voltaje de la unidad N°1 de central Florida II
- Se presume correcta operación de la función de pérdida de excitación de la unidad N°1 de central Florida III
- Faltan antecedentes para evaluar el desempeño de eventuales protecciones operadas de la unidad N°2 de central Florida III
- Se presume correcta operación de la protección de sobrecorriente de fase de central El Rincón

9.3 Desempeño EDAC

No aplica pronunciarse sobre el desempeño de EDAC ante este evento

9.4 Desempeño EDAG

No aplica pronunciarse sobre el desempeño de EDAG ante este evento

10. Análisis de las acciones e instrucciones del CDC y la actuación de los CC que corresponda

No hay observaciones respecto de las actuaciones del CDC y los CC durante la falla del día 16-04-2016

11. Recomendación respecto de las instalaciones a las cuales la DO debería solicitar una auditoría

Se solicitará a Eléctrica Puntilla S.A. el envío de cronograma de trabajo asociado a las medidas correctivas informadas, aclaración respecto de las protecciones operadas de la unidad N°2 de central Florida III y aclaración respecto de la causa primaria de la falla ocurrida

Para el análisis de esta falla no se requirió la realización de auditorías en ninguna de las instalaciones del SIC

ANEXO N° 1

Detalle de la generación programada para el día 16 de abril de 2016

ANEXO N° 2
Detalle de la generación real del día 16 de abril de 2016

Table with columns: Generales, 1-23, Real, Admisión, Prog., and Generación. Rows list various power plants and their output in MWh.

ANEXO N° 3

Detalle del Movimiento de Centrales e Informe de Novedades Relevantes
del CDC correspondientes al día 16 de abril de 2016

16/04/2016									
Hora Movi.	Sincron. de Unidad	Central	POTENCIA (MW)			MOTIVO	Etapa de la Central	Condición del Embalse	Condición de la Central
			SUBE	BAJA	QUEDA				
00:00		Colbun			210	U2 regula frecuencia		Agotamiento	(1) E/S Reguladora
00:00		Rapel			350	Ratifica condición de vertimiento evitable		Vertimiento Evitable	(7) E/S Plena Carga
00:00		Pehuenche			280	Ratifica condición de vertimiento evitable		Vertimiento Evitable	(6) E/S
00:00		Ralco			0	Ratifica condición de agotamiento.		Agotamiento	(8) F/S
00:00		Nehuenco I		50	260	Control Suministro de Gas			(5) E/S Min Técnico
00:00		Nehuenco II		120	260	Control Suministro de Gas			(5) E/S Min Técnico
00:15		Colbún	100		310	Sincroniza U2.	COLBUN_sinv	Normal	(1) E/S Reguladora
00:24		Cipreses		50	0	DCR	CIPRESES_vcuri_loma	Normal	(8) F/S
00:32		Curillinque	80		80	Sincroniza unidad	CIPRESES_sinv	Normal	(7) E/S Plena Carga
00:32		Canutillar		40	40	Mantiene por control Tx L.220 kV Cautín - Ciruelos - Valdivia y Cautín - Valdivia llegada a S/E Valdivia 182 MVA por TT/CC	-	Normal	(5) E/S Min Técnico
00:32		Viñales		6	16	DCR	Viñales_2	-	(7) E/S Plena Carga
00:32		Santa_Fe		14	50	DCR	SANTA_FE_4	-	(7) E/S Plena Carga
00:32		Celco		2	3	DCR	CELCO_1	-	(7) E/S Plena Carga
00:32		LAJA-EVE		7	3	DCR	LAJA-EVE_2	-	(7) E/S Plena Carga
00:32		San Isidro II		130	250	DCR	SANISIDRO_2_GNL	-	(6) E/S
00:38		Angostura		70	110	Control Cota Angostura	RALCO_sinv	Normal	(6) E/S
00:48		San Isidro II		50	200	DCR	SANISIDRO_2_GNL	-	(5) E/S Min Técnico
00:48		Masisa		4.5	4.5	DCR	-	-	(5) E/S Min Técnico
00:48		Viñales		10	6	DCR	Viñales_1	-	(7) E/S Plena Carga
00:48		Arauco		10	0	DCR	ARAUCO_1	-	(8) F/S
00:48		Escuadrón		5.5	6.5	DCR	ESCUADRON	-	(5) E/S Min Técnico
00:48		Lautaro 1		10	16	DCR	LAUTARO_1_BLOQUE_1	-	(7) E/S Plena Carga
00:59		Angostura		40	70	Control Cota Angostura	RALCO_sinv	Normal	(6) E/S
01:10		Angostura	60		130	Control Cota Angostura	RALCO_sinv	Normal	(6) E/S
01:55		Angostura		30	100	Control Cota Angostura	RALCO_sinv	Normal	(6) E/S
01:55		Canutillar			40	Mantiene por regulación de tensión.	-	Normal	(5) E/S Min Técnico
01:58		Angostura		30	70	Control Cota Angostura	RALCO_sinv	Normal	(6) E/S
02:10		Bocamina		53	75	DCR	-	-	(5) E/S Min Técnico
02:10		Santa_Fe		14	36	DCR	SANTA_FE_3	-	(7) E/S Plena Carga
02:20		Ventanas 1		22	68	DCR	-	-	(5) E/S Min Técnico
02:20		Campiche		65	205	DCR	-	-	(6) E/S
02:33		Angostura		25	45	Control Cota Angostura	RALCO_sinv	Normal	(6) E/S
03:33		Mov. CMG				Movimiento para estimar CMG horario	-	-	-
04:30		Campiche	25		230	QCR	-	-	(6) E/S
04:50		Campiche	40		270	QCR	-	-	(7) E/S Plena Carga
05:50		Mov. CMG				Movimiento para estimar CMG horario	-	-	-
05:52		Cholguán		10.5	0	Salida Intempestiva por Falla	CHOLGUAN_1	-	(8) F/S
06:10		Ventanas 1	22		90	Limitada según IL 198/2016.	-	-	(10) E/S con limitación
06:21		Colbún			310	Se solicita segunda unidad.	COLBUN_sinv	Normal	(1) E/S Reguladora
07:21		El Toro		1	4	U1 sincronizada	ELTORO_sinv	Normal	(4) E/S Reserva en Giro
07:49		Santa_Fe	16		50	QCR	SANTA_FE_3	-	(7) E/S Plena Carga
07:49		Bocamina	53		128	QCR	-	-	(7) E/S Plena Carga
08:00		Lautaro 1	10		26	QCR	LAUTARO_1_BLOQUE_2	-	(7) E/S Plena Carga
08:00		Escuadrón	5.5		12	QCR	ESCUADRON	-	(7) E/S Plena Carga
08:00		Arauco	10		10	QCR	ARAUCO_1	-	(7) E/S Plena Carga
08:00		Masisa	4.5		9	QCR	-	-	(7) E/S Plena Carga
08:00		Viñales	10		16	QCR	Viñales_2	-	(7) E/S Plena Carga
08:00		Cipreses			0	Máximo sin verter	CIPRESES_sinv	Normal	(8) F/S
08:00		San Isidro II	50		250	QCR	SANISIDRO_2_GNL	-	(6) E/S
08:25		San Isidro II	30		280	QCR	SANISIDRO_2_GNL	-	(6) E/S
08:27		Loma Los Colorados 1	0.9		0.9	Disponibilidad de gas - Sincroniza Motor Sur	-	-	(6) E/S
08:55		San Isidro II	30		310	QCR	SANISIDRO_2_GNL	-	(6) E/S
09:00		Cipreses	70		70	Nuevo Máximo sin vertimiento	CIPRESES_sinv	Normal	(6) E/S
09:12		Guacolda 5		90	60	Control de Tx L.220 kV Maitencillo - Punta Colorada 350 MVA de N-->S Puede Subir desde las 12:16 Horas	-	-	(5) E/S Min Técnico
09:16		San Isidro II	70		380	QCR	SANISIDRO_2_GNL	-	(7) E/S Plena Carga
09:58		Central Aconcagua		48		Unidad Blanco Salida Intempestiva IF 1112/2016	-	-	-
10:03		LAJA-EVE	7		10	QCR	LAJA-EVE_1	-	(7) E/S Plena Carga
10:03		Nueva Renca	60		300	QCR	NRENCA_GNL	-	(7) E/S Plena Carga
10:17		Santa_Fe	14		64	QCR	SANTA_FE_4	-	(7) E/S Plena Carga
10:17		Celco	2		5	QCR	CELCO_2	-	(7) E/S Plena Carga
10:17		Canutillar	40		80	QCR	-	Normal	(6) E/S
10:23		Viñales	6		22	QCR	Viñales_3	-	(7) E/S Plena Carga
10:23		CMPC Laja	10		15	QCR	CMPC_LAJA_2	-	(7) E/S Plena Carga
10:23		El Toro	56		60	Toma regulación de frecuencia Unidad 2	ELTORO_sinv	Normal	(1) E/S Reguladora
10:23		Colbún	70		380	Deja de regular frecuencia Unidad 1	COLBUN_vmach_sign	Normal	(6) E/S
11:07		Ventanas 2		200	0	Solicitud de Desconexión de Curso Forzoso 2906/2016 // Sale de servicio para reparar tubo roto de caldera.	-	-	(8) F/S
11:07		Antuco	50		140	Control Cota Polcura	ELTORO_sinv	Normal	(6) E/S
11:30		Central Aconcagua	10		10	Sincroniza Unidad Blanco IF 1112/2016	-	-	-
11:48		Total ERNC			-20	Prorrata por Control TX Línea 220 kV San Andrés - Cardones. 222 MVA a 25 °C con Sol flujo N>S.	-	-	(8) F/S
11:48		Total ERNC Solar			-20	Prorrata por Control TX Línea 220 kV San Andrés - Cardones. 222 MVA a 25 °C con Sol flujo N>S.	-	-	(8) F/S

11:48	Total ERNC Eólico	0	0	Prorrata por Control TX Línea 220 kV San Andrés - Cardones. 222 MVA a 25 °C con Sol flujo N>S.				
11:48	C. PFV Lalackama	5	52	Prorrata por Control TX Línea 220 kV San Andrés - Cardones. 222 MVA a 25 °C con Sol flujo N>S.				
11:48	C. PFV Diego de Almagro		19	Central sin variación por Línea 220 kV San Andrés - Cardones				
11:48	C. PFV Chañares	3	25	Prorrata por Control TX Línea 220 kV San Andrés - Cardones. 222 MVA a 25 °C con Sol flujo N>S.				
11:48	C. PFV Javiera	4	45	Prorrata por Control TX Línea 220 kV San Andrés - Cardones. 222 MVA a 25 °C con Sol flujo N>S.				
11:48	C. PFV San Andrés		30	Central sin variación por Línea 220 kV San Andrés - Cardones				
11:48	C. PFV Salvador	4	48	Prorrata por Control TX Línea 220 kV San Andrés - Cardones. 222 MVA a 25 °C con Sol flujo N>S.				
11:48	C. PFV Luz del Norte	4	44	Prorrata por Control TX Línea 220 kV San Andrés - Cardones. 222 MVA a 25 °C con Sol flujo N>S.				
11:48	C. PE Taltal		2	Central sin variación por Línea 220 kV San Andrés - Cardones				
11:50	Cholguán	9	9	Cancela IF 1111/2016	CHOLGUAN_1	-		(7) E/S Plena Carga
12:00	Cipreses		90	Sin verter	CIPRESSES_sinv	Normal		(7) E/S Plena Carga
12:00	Energía Pacifico		17	Limitada según IL 141/2016.	-	-		(10) E/S con limitación
12:00	Licantén	2	4	QCR	LICANTEN_2	-		(7) E/S Plena Carga
12:00	Cementos BioBio		0	No solicitada por costo de partida	CEMENTOS_BIOBIO_F06	-		(8) F/S
12:00	Ralco	90	90	QCR	RALCO_sinv	Agotamiento		(5) E/S Min Técnico
12:05	Teno	20	20	Seguridad sistema de 154 kV	-	-		(5) E/S Min Técnico
12:16	Guacolda 5	60	120	Control de Tx L.220 kV Maitencillo - Punta Colorada 350 MVA de N-->S	-	-		(6) E/S
12:57	Ralco	90	0	DCR	RALCO_sinv	Agotamiento		(8) F/S
12:57	Licantén	2	2	DCR	LICANTEN_1	-		(7) E/S Plena Carga
12:57	Energía Pacifico		17	Limitada según IL 141/2016.	-	-		(10) E/S con limitación
13:48	Guacolda 5	30	150	Control de Tx L.220 kV Maitencillo - Punta Colorada 350 MVA de N-->S	-	-		(7) E/S Plena Carga
13:55	Colbún		310	Por disminución de los requerimientos de riego Colbún con 310MW Vierte en Machicura y San Ignacio	COLBUN_vmach_sign	Normal		(6) E/S
14:55	Mov. CMG			Movimiento para estimar CMG horario	-	-		-
14:56	CMPC Laja	10	5	DCR	CMPC_LAJA_1	-		(7) E/S Plena Carga
14:56	Viñales	6	16	DCR	Viñales_2	-		(7) E/S Plena Carga
14:56	Colbún	50	260	U-1 toma la regulación de frecuencia	COLBUN_vmach_sign	Normal		(1) E/S Reguladora
14:56	El Toro	56	4	Deja de regular frecuencia	ELTORO_sinv	Normal		(4) E/S Reserva en Giro
15:21	Total ERNC		-31	Prorrata por Control TX Línea 220 kV San Andrés - Cardones. 194 MVA a 29 °C con Sol flujo N>S.				
15:21	Total ERNC Solar		-30	Prorrata por Control TX Línea 220 kV San Andrés - Cardones. 194 MVA a 29 °C con Sol flujo N>S.				
15:21	Total ERNC Eólico		-1	Prorrata por Control TX Línea 220 kV San Andrés - Cardones. 194 MVA a 29 °C con Sol flujo N>S.				
15:21	C. PFV Lalackama	7	39	Prorrata por Control TX Línea 220 kV San Andrés - Cardones. 194 MVA a 29 °C con Sol flujo N>S.				
15:21	C. PFV Diego de Almagro	1	17	Prorrata por Control TX Línea 220 kV San Andrés - Cardones. 194 MVA a 29 °C con Sol flujo N>S.				
15:21	C. PFV Chañares	2	20	Prorrata por Control TX Línea 220 kV San Andrés - Cardones. 194 MVA a 29 °C con Sol flujo N>S.				
15:21	C. PFV Javiera	6	34	Prorrata por Control TX Línea 220 kV San Andrés - Cardones. 194 MVA a 29 °C con Sol flujo N>S.				
15:21	C. PFV San Andrés	2	27	Prorrata por Control TX Línea 220 kV San Andrés - Cardones. 194 MVA a 29 °C con Sol flujo N>S.				
15:21	C. PFV Salvador	6	36	Prorrata por Control TX Línea 220 kV San Andrés - Cardones. 194 MVA a 29 °C con Sol flujo N>S.				
15:21	C. PFV Luz del Norte	6	34	Prorrata por Control TX Línea 220 kV San Andrés - Cardones. 194 MVA a 29 °C con Sol flujo N>S.				
15:21	C. PE Taltal	1	29	Prorrata por Control TX Línea 220 kV San Andrés - Cardones. 194 MVA a 29 °C con Sol flujo N>S.				
15:24	Canutillar	20	60	DCR	-	Normal		(6) E/S
15:53	Canutillar	20	80	QCR	-	Normal		(7) E/S Plena Carga
16:07	Canutillar	20	100	Máximo según cota 222.85 m.s.n.m.	-	Normal		(7) E/S Plena Carga
16:09	Total ERNC		-15	Prorrata por Control TX Línea 220 kV San Andrés - Cardones. 187 MVA a 30 °C con Sol flujo N>S.				
16:09	Total ERNC Solar		-15	Prorrata por Control TX Línea 220 kV San Andrés - Cardones. 187 MVA a 30 °C con Sol flujo N>S.				
16:09	Total ERNC Eólico		0	Prorrata por Control TX Línea 220 kV San Andrés - Cardones. 187 MVA a 30 °C con Sol flujo N>S.				
16:09	C. PFV Lalackama	3	36	Prorrata por Control TX Línea 220 kV San Andrés - Cardones. 187 MVA a 30 °C con Sol flujo N>S.				
16:09	C. PFV Diego de Almagro	2	15	Prorrata por Control TX Línea 220 kV San Andrés - Cardones. 187 MVA a 30 °C con Sol flujo N>S.				
16:09	C. PFV Chañares	2	18	Prorrata por Control TX Línea 220 kV San Andrés - Cardones. 187 MVA a 30 °C con Sol flujo N>S.				
16:09	C. PFV Javiera	2	32	Prorrata por Control TX Línea 220 kV San Andrés - Cardones. 187 MVA a 30 °C con Sol flujo N>S.				
16:09	C. PFV San Andrés	2	25	Prorrata por Control TX Línea 220 kV San Andrés - Cardones. 187 MVA a 30 °C con Sol flujo N>S.				
16:09	C. PFV Salvador	2	34	Prorrata por Control TX Línea 220 kV San Andrés - Cardones. 187 MVA a 30 °C con Sol flujo N>S.				
16:09	C. PFV Luz del Norte	2	32	Prorrata por Control TX Línea 220 kV San Andrés - Cardones. 187 MVA a 30 °C con Sol flujo N>S.				
16:09	C. PE Taltal		29	Central sin variación por Línea 220 kV San Andrés - Cardones				
16:43	Total ERNC		14	Prorrata por Control TX Línea 220 kV San Andrés - Cardones. 194 MVA a 29 °C con Sol flujo N>S.				
16:43	Total ERNC Solar		14	Prorrata por Control TX Línea 220 kV San Andrés - Cardones. 194 MVA a 29 °C con Sol flujo N>S.				
16:43	Total ERNC Eólico		0	Prorrata por Control TX Línea 220 kV San Andrés - Cardones. 194 MVA a 29 °C con Sol flujo N>S.				
16:43	C. PFV Lalackama	3	39	Prorrata por Control TX Línea 220 kV San Andrés - Cardones. 194 MVA a 29 °C con Sol flujo N>S.				
16:43	C. PFV Diego de Almagro	2	17	Prorrata por Control TX Línea 220 kV San Andrés - Cardones. 194 MVA a 29 °C con Sol flujo N>S.				
16:43	C. PFV Chañares	1	19	Prorrata por Control TX Línea 220 kV San Andrés - Cardones. 194 MVA a 29 °C con Sol flujo N>S.				
16:43	C. PFV Javiera	2	34	Prorrata por Control TX Línea 220 kV San Andrés - Cardones. 194 MVA a 29 °C con Sol flujo N>S.				
16:43	C. PFV San Andrés	2	27	Prorrata por Control TX Línea 220 kV San Andrés - Cardones. 194 MVA a 29 °C con Sol flujo N>S.				
16:43	C. PFV Salvador	2	36	Prorrata por Control TX Línea 220 kV San Andrés - Cardones. 194 MVA a 29 °C con Sol flujo N>S.				
16:43	C. PFV Luz del Norte	2	34	Prorrata por Control TX Línea 220 kV San Andrés - Cardones. 194 MVA a 29 °C con Sol flujo N>S.				
16:43	C. PE Taltal		24	Central sin variación por Línea 220 kV San Andrés - Cardones				
16:47	Canutillar	60	40	Mantiene por control tensiones zona sur	-	Normal		(5) E/S Min Técnico
16:47	Celco	2	3	DCR	CELCO_1	-		(7) E/S Plena Carga
16:47	Santa_Fe	14	50	DCR	SANTA_FE_3	-		(7) E/S Plena Carga
16:47	Nueva Renca	60	240	QCR	NRENCA_GNL	-		(5) E/S Min Técnico
16:47	LAJA-EVE	7	3	DCR	LAJA-EVE_2	-		(7) E/S Plena Carga
16:47	San Isidro II	50	300	DCR	SANISIDRO_2_GNL	-		(6) E/S
16:59	San Isidro II	30	300	DCR	SANISIDRO_2_GNL	-		(6) E/S
17:12	San Isidro II	50	250	DCR	SANISIDRO_2_GNL	-		(6) E/S
17:14	Teno	20	0	Seguridad sistema de 154 kV	-	-		(8) F/S
17:20	Total ERNC		11	Prorrata por Control TX Línea 220 kV San Andrés - Cardones. 202 MVA a 28 °C con Sol flujo N>S.				

17:20	Total ERNC Solar	11	Prorrata por Control TX Línea 220 kV San Andrés - Cardones. 202 MVA a 28 °C con Sol	flujo N>S.					
17:20	Total ERNC Eólico	0	Prorrata por Control TX Línea 220 kV San Andrés - Cardones. 202 MVA a 28 °C con Sol	flujo N>S.					
17:20	C. PFV Lalackama	2	41	Prorrata por Control TX Línea 220 kV San Andrés - Cardones. 202 MVA a 28 °C con Sol	flujo N>S.				
17:20	C. PFV Diego de Almagro	1	18	Prorrata por Control TX Línea 220 kV San Andrés - Cardones. 202 MVA a 28 °C con Sol	flujo N>S.				
17:20	C. PFV Chañares	1	20	Prorrata por Control TX Línea 220 kV San Andrés - Cardones. 202 MVA a 28 °C con Sol	flujo N>S.				
17:20	C. PFV Javiera	2	36	Prorrata por Control TX Línea 220 kV San Andrés - Cardones. 202 MVA a 28 °C con Sol	flujo N>S.				
17:20	C. PFV San Andrés	1	28	Prorrata por Control TX Línea 220 kV San Andrés - Cardones. 202 MVA a 28 °C con Sol	flujo N>S.				
17:20	C. PFV Salvador	2	38	Prorrata por Control TX Línea 220 kV San Andrés - Cardones. 202 MVA a 28 °C con Sol	flujo N>S.				
17:20	C. PFV Luz del Norte	2	36	Prorrata por Control TX Línea 220 kV San Andrés - Cardones. 202 MVA a 28 °C con Sol	flujo N>S.				
17:20	C. PE Taltal		24	Central sin variación por Línea 220 kV San Andrés - Cardones					
17:26	San Isidro II	50	200	DCR		SANISIDRO_2_GNL			(5) E/S Min Técnico
17:32	Cipreses	88	2	Control Reserva en Giro		CIPRESES_sinv	Normal		(8) F/S
17:32	Viñales	10	6	DCR		Viñales_1	-		(7) E/S Plena Carga
17:32	Masisa	4.5	4.5	No se retira por restricciones propias		-	-		(5) E/S Min Técnico
17:32	Guacolda 5		150	Mantiene por pronto cambio en la política de precio y tiempo de estabilización		-	-		(7) E/S Plena Carga
17:32	Guacolda 4		150	Mantiene por pronto cambio en la política de precio y tiempo de estabilización		-	-		(7) E/S Plena Carga
17:32	Guacolda 2		150	Mantiene por pronto cambio en la política de precio y tiempo de estabilización		-	-		(7) E/S Plena Carga
17:32	Guacolda 1		150	Mantiene por pronto cambio en la política de precio y tiempo de estabilización		-	-		(7) E/S Plena Carga
17:32	Arauco	10	0	DCR		ARAUCO_1	-		(8) F/S
17:32	Guacolda 3		0	F/S según SD 12803/2016		-	-		(8) F/S
17:32	Escuadrón	5.5	6.5	No se retira por restricciones propias		ESCUADRON			(5) E/S Min Técnico
17:32	Lautaro 1	10	16	DCR		LAUTARO_1_BLOQUE_1	-		(7) E/S Plena Carga
17:32	Bocamina	53	75	DCR		-	-		(5) E/S Min Técnico
17:32	Santa_Fe	16	34	DCR		SANTA_FE_2	-		(7) E/S Plena Carga
17:32	Ventanas 1	30	60	Limitada según IL 198/2016.		-	-		(5) E/S Min Técnico
17:32	Bocamina II		0	F/S según SD 2560/2016		-	-		(8) F/S
17:32	Campiche	65	205	DCR		-	-		(6) E/S
17:32	Lautaro 2	7	15	DCR		-	-		(5) E/S Min Técnico
17:32	Nueva Ventanas	65	205	DCR		NUEVA VENTANAS	-		(6) E/S
17:34	Total ERNC		12	Prorrata por Control TX Línea 220 kV San Andrés - Cardones. 202 MVA a 28 °C con Sol	flujo N>S.				
17:34	Total ERNC Solar		12	Prorrata por Control TX Línea 220 kV San Andrés - Cardones. 202 MVA a 28 °C con Sol	flujo N>S.				
17:34	Total ERNC Eólico		0	Prorrata por Control TX Línea 220 kV San Andrés - Cardones. 202 MVA a 28 °C con Sol	flujo N>S.				
17:34	C. PFV Lalackama	3	44	Prorrata por Control TX Línea 220 kV San Andrés - Cardones. 202 MVA a 28 °C con Sol	flujo N>S.				
17:34	C. PFV Diego de Almagro		8	Central sin variación por Línea 220 kV San Andrés - Cardones					
17:34	C. PFV Chañares	1	21	Prorrata por Control TX Línea 220 kV San Andrés - Cardones. 202 MVA a 28 °C con Sol	flujo N>S.				
17:34	C. PFV Javiera		36	Central sin variación por Línea 220 kV San Andrés - Cardones					
17:34	C. PFV San Andrés	2	30	Prorrata por Control TX Línea 220 kV San Andrés - Cardones. 202 MVA a 28 °C con Sol	flujo N>S.				
17:34	C. PFV Salvador	3	41	Prorrata por Control TX Línea 220 kV San Andrés - Cardones. 202 MVA a 28 °C con Sol	flujo N>S.				
17:34	C. PFV Luz del Norte	3	39	Prorrata por Control TX Línea 220 kV San Andrés - Cardones. 202 MVA a 28 °C con Sol	flujo N>S.				
17:34	C. PE Taltal		24	Central sin variación por Línea 220 kV San Andrés - Cardones					
17:44	Pehuenche	100	180	DCR		-	Vertimiento Evitable		(6) E/S
17:48	Fin Prorrata			Fin prorrata por control Tx Línea 220 kV San Andrés - Cardones.					
18:00	Lautaro 1	1	15	Cambio en la Política de Precios		LAUTARO_1_BLOQUE_1	-		(5) E/S Min Técnico
18:01	Pehuenche	30	210	QCR		-	Vertimiento Evitable		(6) E/S
18:09	Pehuenche	70	280	QCR		-	Vertimiento Evitable		(7) E/S Plena Carga
18:17	Nueva Ventanas	65	270	QCR		NUEVA VENTANAS	-		(7) E/S Plena Carga
18:17	Lautaro 1	1	16	QCR		LAUTARO_1_BLOQUE_1	-		(7) E/S Plena Carga
18:17	Campiche	65	270	QCR		-	-		(7) E/S Plena Carga
18:25	Lautaro 2	7	22	QCR		-	-		(7) E/S Plena Carga
18:25	Ventanas 1	30	90	Limitada según IL 198/2016. cumple tiempo de estabilización a las 20:58 hrs.		-	-		(10) E/S con limitación
18:25	Santa_Fe	16	50	QCR		SANTA_FE_3	-		(7) E/S Plena Carga
18:25	Bocamina	53	128	QCR cumple tiempo de estabilización a las 20:15 hrs.		-	-		(7) E/S Plena Carga
18:25	Lautaro 1	10	26	QCR		LAUTARO_1_BLOQUE_2	-		(7) E/S Plena Carga
18:25	Arauco	10	10	QCR		ARAUCO_1	-		(7) E/S Plena Carga
18:25	Escuadrón	5.5	12	QCR		ESCUADRON	-		(7) E/S Plena Carga
18:25	Masisa	4.5	9	QCR		-	-		(7) E/S Plena Carga
18:25	San Isidro II	180	380	QCR cumple tiempo de estabilización a las 18:51 hrs.		SANISIDRO_2_GNL			(7) E/S Plena Carga
18:25	Cipreses	68	70	QCR		CIPRESES_sinv	Normal		(7) E/S Plena Carga
19:11	LAJA-EVE	7	10	QCR		LAJA-EVE_1	-		(7) E/S Plena Carga
19:11	Nueva Renca	60	300	QCR		NRENCA_GNL			(7) E/S Plena Carga
19:17	Viñales	10	16	QCR		Viñales_2	-		(7) E/S Plena Carga
19:17	Santa_Fe	14	64	QCR		SANTA_FE_4	-		(7) E/S Plena Carga
19:17	Canutillar	60	100	QCR		-	Normal		(7) E/S Plena Carga
19:24	Celco	2	5	QCR		CELCO_2	-		(7) E/S Plena Carga
19:24	Viñales	6	22	QCR		Viñales_3	-		(7) E/S Plena Carga
19:24	Taltal 1		0	No solicitada por costo de partida		TALTAL_1_GNL_1			(8) F/S
19:24	El Toro	66	70	QCR		ELTORO_sinv	Normal		(6) E/S
19:36	El Toro	80	150	QCR		ELTORO_sinv	Normal		(6) E/S
19:43	El Toro	50	200	QCR		ELTORO_sinv	Normal		(6) E/S
19:52	El Toro	60	260	QCR		ELTORO_sinv	Normal		(6) E/S
20:23	El Toro	60	200	DCR		ELTORO_sinv	Normal		(6) E/S
21:07	El Toro	40	160	DCR		ELTORO_sinv	Normal		(6) E/S
21:19	El Toro	60	100	DCR		ELTORO_sinv	Normal		(6) E/S

21:33	El Toro	50	50	No se retira en condición especial por control cota polcura	ELTORO_sinv	Normal	(6) E/S
21:33	Viñales	6	16	DCR	Viñales_2	-	(7) E/S Plena Carga
21:33	Celco	2	3	DCR	CELCO_1	-	(7) E/S Plena Carga
21:33	Canutillar	60	40	DCR y queda por control tensiones zona sur	-	Normal	(5) E/S Min Técnico
21:33	Santa_Fe	14	50	DCR	SANTA_FE_3	-	(7) E/S Plena Carga
21:33	Viñales	10	6	DCR	Viñales_1	-	(7) E/S Plena Carga
21:33	Nueva Renca	60	240	DCR	NRENCA_GNL	-	(5) E/S Min Técnico
21:33	LAJA-EVE	7	3	DCR	LAJA-EVE_2	-	(7) E/S Plena Carga
21:42	El Toro		50	U-2 toma la regulación de frecuencia	ELTORO_sinv	Normal	(1) E/S Reguladora
21:42	Colbún		210	Deja de regular frecuencia y queda al máximo sin verter en Machicura y San Ignacio	COLBUN_sinv	Normal	(1) E/S Reguladora
22:21	Cipreses	70	0	DCR	CIPRESES_sinv	Normal	(8) F/S
22:48	San Isidro II	80	300	DCR	SANISIDRO_2_GNL	-	(6) E/S
23:02	San Isidro II	50	250	DCR	SANISIDRO_2_GNL	-	(6) E/S
23:25	San Isidro II	20	230	DCR	SANISIDRO_2_GNL	-	(6) E/S
23:37	San Isidro II	40	270	QCR	SANISIDRO_2_GNL	-	(6) E/S
23:39	Nueva Renca	30	210	Limitada por alta diferencia en filtros de entrada de aire TG. IL1028	NRENCA_GNL	-	(10) E/S con limitación

INFORME DE NOVEDADES CDC

Sábado 16 de Abril de 2016



1. RESUMEN EJECUTIVO

RESUMEN DIARIO OPERACIÓN SIC

Energía Embalsada en los Últimos 12 Meses (GWh)

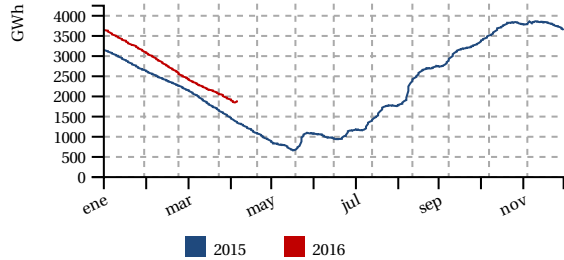

Generación horaria bruta por tecnología (MW/h)

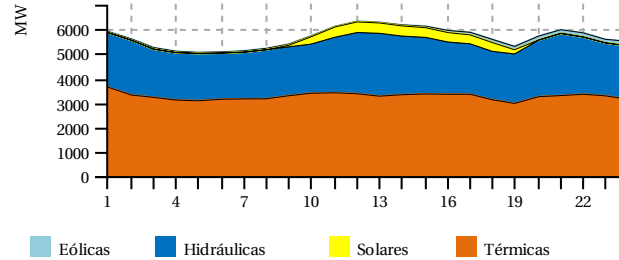

Costo Marginal Real Preliminar (USD/MWh)

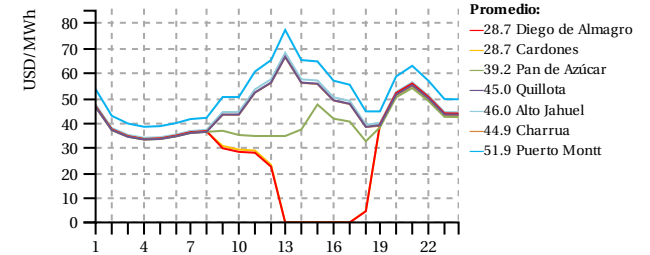

Generación por Fuente

	Diario (GWh)		Mensual (GWh) (*)		Acumulado Anual (TWh) (*)			
	Sáb 16/apr	2016	2015	var%	2016	2015	var%	
Eólica	1.9	1.4%	64.6	65.3	-1.07	0.44	0.38	15.40
Hidráulica	51.5	38.0%	708.2	723.5	-2.12	6.03	5.62	6.38
Solar	3.7	2.7%	50.7	35.3	43.61	0.40	0.26	54.01
Térmica	78.7	57.9%	1478.9	1375.4	7.53	9.11	9.21	-2.01
Total	135.8	100%	2302.3	2199.5	4.68	15.99	15.47	2.40

Generación Térmica

	Diario (GWh)		Mensual (GWh) (*)		Acumulado Anual (TWh) (*)			
	Sáb 16/apr	2016	2015	var%	2016	2015	var%	
BioGas	0.7	0.8%	9.1	10.3	-12.05	0.06	0.07	-18.76
Biomasa	6.9	8.8%	118.3	97.8	21.02	0.71	0.67	5.24
Carbón	44.2	56.1%	803.6	570.5	40.86	4.97	4.18	17.83
Diésel	0.1	0.2%	11.7	74.9	-84.43	0.23	0.43	-47.07
Gas Natural	26.8	34.1%	536.2	614.9	-12.81	3.14	3.83	-18.81
Total	78.7	100%	1478.8	1368.4	8.07	9.11	9.18	-1.69

Generación Renovable no Convencional

	Diario (GWh)		Mensual (GWh) (*)		Acumulado Anual (TWh) (*)			
	Sáb 16/apr	2016	2015	var%	2016	2015	var%	
BioGas	0.7	4.1%	9.1	10.3	-12.07	0.06	0.07	-18.76
Biomasa	6.4	40.3%	101.7	79.2	28.39	0.51	0.56	-10.05
Eólica	1.9	12.2%	64.6	63.4	1.75	0.44	0.37	18.02
Minihidro	3.2	20.1%	41.9	40.4	3.59	0.32	0.28	12.71
Solar	3.7	23.3%	50.7	35.0	45.09	0.40	0.26	54.56
Total	15.8	100%	267.9	228.3	17.33	1.73	1.54	11.31

Generación Hidráulica

	Diario (GWh)		Mensual (GWh) (*)		Acumulado Anual (TWh) (*)			
	Sáb 16/apr	2016	2015	var%	2016	2015	var%	
Embalse	27.3	53.0%	339.8	360.4	-5.72	2.49	2.46	0.50
Pasada	24.2	47.0%	368.3	363.1	1.45	3.54	3.16	10.95
Total	51.5	100%	708.2	723.5	-2.12	6.03	5.62	6.38

Reducción Energía Eólica y Solar

	Diario (MWh)		Mensual (GWh) (*)		Acumulado Anual (GWh) (*)		
	Sáb 16/apr	2016	2015	var%	2016	2015	var%
Total	217.8	4.2	4.5	-6.71	45.98	7.22	530.62

Costos Marginales Promedios Programados (USD/MWh)

Fuente	Diario			Promedio Anual (*)		
	Sáb 16/apr	Vie 15/apr	var%	2016	2015	var%
Maitencillo	44.2	51.4	-14.03	52.7	122.3	-56.88
Quillota	47.0	56.2	-16.43	59.2	133.4	-55.64
Charrúa	47.0	56.2	-16.43	58.9	133.4	-55.86
Promedio	46.1	54.6	-15.68	56.9	129.7	-56.10

Precipitaciones (mm)

Fuente	Diario		Acumulado Anual (*)		
	Sáb 16/apr	Vie 15/apr	2016	var% 2015	var% Año Normal
Rapel	11.3	22.7	70.7	-	321.72
Invernada	35.0	65.0	167.0	589.33	86.14
Melado	24.8	49.1	121.9	319.31	27.29
Colbún	19.8	71.8	157.3	379.32	26.27
Laja	0.0	34.0	107.0	1666.67	-46.05
Pangue	0.0	19.0	125.6	724.01	-59.18
Chapo	0.0	24.5	320.0	-4.23	-51.18

Cotas (msnm)

Fuente	Diario		Máxima	Mín. Operacional
	Sáb 16/apr	Vie 15/apr	2016	2016
Chapo	222.85	222.77	243.00	222.00
Invernada	1296.99	1296.76	1318.00	1282.80
Laja	1319.35	1319.37	1368.00	1308.48
Colbun	420.86	420.63	437.00	397.00
Rapel	103.26	101.63	105.00	100.50
Ralco	692.67	692.36	725.00	692.00
Melado	645.18	643.65	648.00	641.00
Pangue	505.24	505.64	510.00	501.00

Demanda Máxima (MW) y Generación (GWh)

	Diario			Máximo Anual (*)		
	Sáb 16/apr	Vie 15/apr	var%	2016	2015	var%
Máxima Horaria	6320.7	7219.5	-12.45	7784.6	7544.3	3.19

	Programado	Hora	Real	Hora	var%
Demanda Máx.	6316.0	12	6320.7	12	0.07
Demanda Punta	6057.0	21	5977.8	21	-1.31
Generación Total	137.2	-	135.8	-	-0.99

Crecimiento anual

2.40%

Costo Marginal Real Preliminar Barra 220 kV Quillota

45.0 USD/MWh

Participación anual ERNC

10.81%

(*) Representa el acumulado a igual fecha 2016 y 2015

2. DESVIACIONES DE LA PROGRAMACION

2.1. Centrales

Centrales	Prog.	Real	Desv %	Estado
Abanico	696.0	697.0	+0.14 %	
Alfalfal	1796.0	2058.0	+14.59 %	IF
Alto Renaico	-	0.0	-	PMG
Andes Generación	-	0.0	-	
Angostura	840.0	1219.0	+45.12 %	
Antihue TG	0.0	0.0	-	
Antuco	2460.0	2276.0	-7.48 %	IL
Arauco	240.0	180.8	-24.67 %	
Blanco	360.0	721.3	+100.36 %	
Bocamina	3072.0	2585.0	-15.85 %	
Bocamina 2	0.0	219.0	GNP	IL
Callao	11.0	53.2	+383.18 %	
Calle Calle	0.0	0.0	-	IF
Campiche	6528.0	6323.0	-3.14 %	
Candelaria 1	0.0	0.0	-	
Candelaria 1 Diésel	0.0	0.0	-	
Candelaria 1 GNL	0.0	0.0	-	
Candelaria 2	0.0	0.0	-	
Candelaria 2 Diésel	0.0	0.0	-	
Candelaria 2 GNL	0.0	0.0	-	
Canutillar	1810.0	1421.0	-21.49 %	IL
Capullo	65.0	190.0	+192.31 %	
Cardones	0.0	0.0	-	
Carena	216.0	201.2	-6.85 %	
Carilafquén	-	0.0	-	
Celco	86.0	120.2	+39.77 %	
Cementos Bío Bío	0.0	0.0	-	IL
Cenizas	0.0	0.0	-	IF
Chacabuquito	0.0	0.0	-	IF
Chacayes	0.0	0.0	-	IF
Chiburgo	0.0	0.0	-	
Chiloé	0.0	0.0	-	
Cholguán	216.0	195.5	-9.49 %	
Chuyaca	0.0	0.0	-	
Cipreses	1940.0	932.0	(*) -51.96 %	
CMPC Cordillera	-	377.8	GNP	
CMPC Laja	160.0	224.6	+40.38 %	
CMPC Pacífico	0.0	20.5	GNP	PMM
CMPC Santa Fe	0.0	0.0	-	PMM
CMPC Tissue	-	10.0	GNP	
Colbún	6800.0	6138.0	-9.74 %	
Colihues Diésel	0.0	0.0	-	
Colihues HFO	0.0	0.0	-	
Colmito Diésel	0.0	0.0	-	
Colmito GNL	0.0	0.0	-	

Centrales	Prog.	Real	Desv %	Estado
Los Molles	111.0	153.0	+37.84 %	
Los Pinos	0.0	0.0	-	
Los Quilos	519.0	714.0	+37.57 %	
Los Vientos	0.0	0.0	-	
Machicura	1152.0	1176.0	+2.08 %	PMM, IL
Maitenes	301.0	302.0	+0.33 %	PMM
Malalcahuello	-	0.0	-	
Mampil	387.0	330.4	-14.62 %	
Mariposas	60.0	87.6	+46.00 %	
Masisa	168.0	157.3	-6.37 %	IL
Maule	0.0	0.0	-	
Nalcas	0.0	0.0	-	IF
Nehuenco 9B Diésel	0.0	0.0	-	
Nehuenco 9B Gas	0.0	0.0	-	
Nehuenco 9B GNL	0.0	0.0	-	
Nehuenco Diésel	0.0	0.0	-	
Nehuenco Gas	0.0	0.0	-	
Nehuenco GNL	6000.0	6418.0	+6.97 %	
Nehuenco II Diésel	0.0	0.0	-	
Nehuenco II Gas	0.0	0.0	-	
Nehuenco II GNL	6240.0	6438.0	+3.17 %	
Newen Diésel	0.0	0.0	-	
Newen Gas	0.0	0.0	-	
Nueva Aldea 1	336.0	240.8	-28.33 %	
Nueva Aldea 2	0.0	0.0	-	IF
Nueva Aldea 3	792.0	529.5	-33.14 %	
Nueva Renca Diésel	0.0	0.0	-	
Nueva Renca FA_GLP	-	-	-	
Nueva Renca FA_GNL	-	-	-	
Nueva Renca GNL	6490.0	6381.0	-1.68 %	
Nueva Ventanas	6528.0	6499.0	-0.44 %	
Ojos de Agua	144.0	146.6	+1.81 %	
Olivos	0.0	0.0	-	
Palmucho	576.0	552.0	-4.17 %	
Pangue	840.0	840.0	-	
Parque Eólico La Esperanza	-	0.0	-	PMG
Parque Pampa Solar Norte	-	472.4	GNP	
Pehuenche	4739.0	6603.0	(*) +39.33 %	PMM
Petropower	1560.0	1533.0	-1.73 %	
Peuchén	459.0	395.0	-13.95 %	
Picoiquén	152.0	120.9	-20.46 %	
Pilmaiquén	195.0	199.6	+2.36 %	SDCF
Placilla	0.0	0.0	-	
Planta Valdivia	504.0	1042.9	+106.92 %	
Providencia	36.0	199.5	+454.17 %	

Centrales	Prog.	Real	Desv %	Estado
Concón	0.0	0.0	-	
Constitución	0.0	0.0	-	PMG
Coronel TG	0.0	0.0	-	IL
Coronel TG Diésel	0.0	0.0	-	
Coya	0.0	0.0	-	SDCF
Curillínque	1804.0	1548.0	-14.19 %	
Degañ	0.0	9.3		GNP
Diego de Almagro	0.0	0.0	-	
El Paso	480.0	771.4	+60.71 %	
El Peñón	0.0	0.0	-	
El Rincón	0.0	4.5		GNP
El Salvador	0.0	0.0	-	
El Toro	680.0	1451.0	(*) +113.38 %	
El Totoral	0.0	0.0	-	IF
Emelda 1	0.0	0.0	-	
Emelda 2	0.0	0.0	-	
Energía Pacífico	384.0	385.6	+0.42 %	IL
Eólica Canela	24.0	1.8	-92.50 %	
Eólica Canela 2	102.0	0.0	-100.00 %	
Eólica Cuel	295.0	233.0	-21.02 %	
Eólica El Arrayán	105.0	40.7	-61.24 %	
Eólica Lebu	103.0	97.8	-5.05 %	
Eólica Los Cururos	19.0	104.8	+451.58 %	
Eólica Monte Redondo	57.0	33.8	-40.70 %	
Eólica Punta Colorada	72.0	76.5	+6.25 %	
Eólica Punta Palmeras	45.0	16.9	-62.54 %	
Eólica San Pedro	161.0	157.4	-2.24 %	
Eólica Talinay Oriente	285.0	315.5	+10.70 %	
Eólica Talinay Poniente	109.0	138.7	+27.25 %	
Eólica Taltal	795.0	487.5	-38.68 %	
Eólica Totoral	64.0	9.8	-84.69 %	
Eólica Ucuquer 2	24.0	19.9	-16.96 %	
Escuadrón	288.0	213.5	-25.87 %	
Esperanza 1	0.0	0.0	-	
Esperanza 2	0.0	0.0	-	
Esperanza TG	0.0	0.0	-	
Espinos	0.0	0.0	-	
Florida	290.0	229.4	-20.90 %	
Guacolda 1	3648.0	3644.5	-0.09 %	IL
Guacolda 2	3648.0	3562.9	-2.33 %	IL
Guacolda 3	0.0	0.0	-	PMM
Guacolda 4	3648.0	3645.0	-0.08 %	IL
Guacolda 5	3242.0	3344.0	+3.15 %	IL
Guayacán	290.0	134.6	-53.59 %	
Horcones Diésel	0.0	0.0	-	IL
Horcones TG	0.0	0.0	-	IL
Hornitos	448.0	791.1	+76.58 %	
Huasco TG	0.0	0.0	-	
Huasco TG IFO	0.0	0.0	-	
Isla	1511.0	1428.0	-5.49 %	
Itata	-	64.0		GNP
Juncal	278.0	398.9	+43.49 %	
La Confluencia	0.0	0.0	-	IF, IL
Laguna Verde TG	0.0	0.0	-	IF
Laguna Verde TV	0.0	0.0	-	
La Higuera	0.0	0.0	-	IL
Laja Energía Verde	139.0	59.0	-57.55 %	
Laja I	200.0	196.9	-1.55 %	
Las Vegas	0.0	0.0	-	
Lautaro 1	384.0	545.1	+41.95 %	

Centrales	Prog.	Real	Desv %	Estado
Pulelfu	-	183.9	-	PMG
Pullínque	311.0	163.9	-47.30 %	
Punta Colorada Diésel	0.0	0.0	-	
Punta Colorada IFO	0.0	0.0	-	
Puntilla	408.0	126.9	-68.90 %	SDCF
Quellón 2	0.0	0.0	-	SDCF
Queltehues	998.0	551.0	-44.79 %	
Quilleco	584.0	564.0	-3.42 %	PMM
Quintay	0.0	0.0	-	
Quintero Diésel	0.0	0.0	-	IL
Quintero GNL	0.0	0.0	-	
Ralco	0.0	74.0		GNP
Rapel	9000.0	8666.0	-3.71 %	
Renaico	144.0	167.5	+16.32 %	
Renca	0.0	0.0	-	
Río Huasco	24.0	33.4	+39.17 %	
Rucatayo	163.0	165.2	+1.36 %	
Rucúe	1344.0	1197.0	-10.94 %	PMM
San Andrés	250.0	813.8	+225.53 %	
San Clemente	0.0	0.0	-	
San Gregorio	0.0	0.0	-	
San Ignacio	679.0	713.0	+5.01 %	
San Isidro Diésel	0.0	0.0	-	IL
San Isidro Gas	0.0	0.0	-	
San Isidro GNL	410.0	0.0	-100.00 %	
San Isidro II Diésel	0.0	0.0	-	IL
San Isidro II Gas	0.0	0.0	-	
San Isidro II GNL	7546.0	7213.0	-4.41 %	
San Lorenzo U1	0.0	0.0	-	
San Lorenzo U2	0.0	0.0	-	
San Lorenzo U3	0.0	0.0	-	
Santa Fe Energía	1277.0	1708.5	+33.79 %	
Santa Lidia	0.0	0.0	-	
Santa María	8400.0	8502.0	+1.21 %	IL
Santa Marta	192.0	169.8	-11.56 %	IL
Sauzal	879.0	218.0	-75.20 %	IL
Sauzal 60 Hz	0.0	0.0	-	
Sauzalito	183.0	28.0	-84.70 %	SDCF
Solar Carrera Pinto	-	192.4		GNP
Solar Chañares	209.0	212.4	+1.63 %	
Solar Diego de Almagro	184.0	134.6	-26.85 %	IL
Solar Javiera	390.0	376.5	-3.46 %	
Solar Lalackama	323.0	345.0	+6.81 %	
Solar Lalackama 2	108.0	102.8	-4.81 %	
Solar La Silla	-	0.0	-	
Solar Llano de Llampos	590.0	647.0	+9.66 %	
Solar Loma Los Colorados	-	2.1	-	PMG
Solar Luz del Norte	392.0	399.0	+1.79 %	IL
Solar PV Salvador	452.0	424.3	-6.13 %	
Solar San Andrés	319.0	260.3	-18.40 %	IL
Solar SDGx01	4.0	6.7	+67.00 %	PMG
Taltal 1 Diésel	0.0	0.0	-	
Taltal 1 Gas	0.0	0.0	-	
Taltal 1 GNL	0.0	0.0	-	
Taltal 2 Diésel	0.0	0.0	-	
Taltal 2 Gas	0.0	0.0	-	
Taltal 2 GNL	0.0	0.0	-	
Teno	0.0	109.0		GNP
Termopacífico	0.0	0.0	-	
Trapén	300.0	0.0	-100.00 %	

Centrales	Prog.	Real	Desv %	Estado
Lautaro 2	504.0	492.5	-2.28 %	
Licán	374.0	406.6	+8.72 %	
Licantén	120.0	111.1	-7.42 %	
Linares Norte	0.0	0.0	-	PMG
Lircay	446.4	243.9	-45.36 %	
Llauquereo	24.0	20.9	-12.92 %	PMG
Loma Alta	783.0	651.0	-16.86 %	
Loma Los Colorados I	24.0	9.1	-62.08 %	
Loma Los Colorados II	384.0	366.6	-4.53 %	
Los Guindos	0.0	0.0	-	
Los Hierros	188.0	356.2	+89.48 %	
Los Hierros II	34.0	67.8	+99.41 %	

Centrales	Prog.	Real	Desv %	Estado
Ventanas 1	2160.0	2152.0	-0.37 %	IL
Ventanas 2	4800.0	2148.0	(*) -55.25 %	IL, SDCF
Viñales	388.0	686.4	+76.91 %	
Volcán	304.0	272.0	-10.53 %	
Yungay 1 Diésel	0.0	0.0	-	
Yungay 1 Gas	0.0	0.0	-	
Yungay 2 Diésel	0.0	0.0	-	
Yungay 2 Gas	0.0	0.0	-	
Yungay 3 Diésel	0.0	0.0	-	
Yungay 3 Gas	0.0	0.0	-	
Yungay 4	0.0	0.0	-	

2.2. PMGD

Centrales	Prog.	Real	Desv %
Allipén	26.0	38.4	+47.69 %
Ancali	0.0	0.0	-
Auxiliar del Maipo	91.0	58.7	-35.55 %
Biocruz	0.0	0.0	-
Biomar	0.0	0.0	-
Cañete	0.0	0.0	-
Casablanca 1	0.0	0.0	-
Casablanca 2	0.0	0.0	-
Chufkén (Traiguén)	0.0	0.0	-
Collil	0.0	127.8	-
Contulmo	0.0	0.0	-
Curacautin	0.0	0.6	-
Curauma	0.0	0.0	-
Danisco	0.0	0.0	-
Doña Hilda	0.0	0.0	-
Dongo	0.0	0.0	-
Donguil	0.0	3.6	-
Don Walterio	41.0	71.2	+73.56 %
Eagon	0.0	0.0	-
El Canelo	48.0	37.6	-21.67 %
El Diuto	72.0	68.2	-5.28 %
El Llano	12.0	0.0	-100.00 %
El Manzano	49.0	53.9	+10.00 %
El Tártaro	0.0	0.0	-
Energía León (Coelemu)	0.0	0.0	-
Ensenada	0.0	0.0	-
Eólica Huajache	-	0.0	-
Eólica Raki	176.0	171.3	-2.67 %
Eólica Ucuquer	66.0	22.8	-65.41 %
Estancilla	0.0	0.0	-
Eyzaguirre	24.0	12.0	-50.00 %
HBS	0.0	0.0	-
Hidrobonito MC1	117.0	107.4	-8.22 %
Hidrobonito MC2	20.0	28.9	+44.45 %
JCE	0.0	0.0	-
Juncalito	0.0	16.2	-
La Arena	0.0	97.2	-
La Chapeana	-	0.0	-
La Paloma	0.0	0.0	-
Las Flores	0.0	38.4	-
Las Pampas	0.0	0.5	-

Centrales	Prog.	Real	Desv %
Los Padres	0.0	7.9	-
Louisiana Pacific	0.0	0.0	-
Louisiana Pacific II	0.0	0.0	-
Maisan	0.0	3.0	-
Mallarauco	72.0	71.5	-0.71 %
MALLECO	0.0	0.0	-
María Elena	0.0	4.8	-
Molinera Villarrica	-	0.4	-
Monte Patria	0.0	0.0	-
Muchi	0.0	0.0	-
Multiexport I	0.0	0.0	-
Multiexport II	0.0	0.0	-
Pehui	10.0	0.0	-100.00 %
Pichilonco	24.0	6.7	-72.29 %
Planta Curicó	0.0	0.0	-
Puclaro	24.0	26.2	+9.17 %
Punitaqui	0.0	0.0	-
Purísima	0.0	5.7	-
Quillaileo	5.0	5.2	+4.60 %
Reca	0.0	20.3	-
Robleria	0.0	35.5	-
Salmofood I	0.0	0.0	-
Santa Irene	0.0	0.0	-
Sauce Andes	14.0	12.1	-13.36 %
Skretting	0.0	0.0	-
Skretting Osorno	0.0	0.0	-
Solar El Pilar - Los Amarillos	-	0.0	-
Solar Esperanza	0.0	0.0	-
Solar Lagunilla	-	10.6	-
Solar Las Terrazas	25.0	19.7	-21.04 %
Solar Luna	16.0	11.0	-31.25 %
Solar Pama	6.0	6.9	+15.17 %
Solar PSF Lomas Coloradas	6.0	7.4	+22.50 %
Solar Santa Cecilia	16.0	16.8	+5.00 %
Solar Sol	16.0	11.2	-30.00 %
Solar Tambo Real	11.0	16.2	+47.27 %
Solar Techos de Altamira	0.0	0.1	-
Southern	0.0	0.0	-
Tamm	0.0	0.0	-
Tapihue	0.0	0.0	-
Tirúa	0.0	0.0	-

Centrales	Prog.	Real	Desv %
Las Vertientes	12.0	0.0	-100.00 %
Lebu	0.0	0.0	-
Lonquimay	0.0	0.0	-
Los Álamos	0.0	0.0	-
Los Bajos	120.0	59.2	-50.63 %
Los Corrales	5.0	21.6	+332.00 %
Los Corrales II	0.0	6.9	-
Los Morros	48.0	30.6	-36.25 %

Centrales	Prog.	Real	Desv %
Tomaval	0.0	0.0	-
Trailelfú	-	8.9	-
Trebal Mapocho	0.0	107.5	-
Trongol	0.0	0.0	-
Trueno	2.0	17.9	+795.00 %
Truful Truful	24.0	17.5	-26.96 %
Watts I	0.0	0.0	-
Watts II	0.0	0.0	-

Abreviaturas:

GNP: Generación no programada

IF: Indisponibilidad por Falla

IL: Informe de Limitación de Unidades Generadoras

PMG: Pequeño Medio de Generación

PMGD: Pequeño Medio de Generación Distribuida

PMM: Programa de Mantenimiento Mayor

PMMeP: Programa de Mantenimiento Mayor con extensión de plazo

SDCF: Solicitud de desconexión de curso forzoso

SI: Sin información

JUSTIFICACIÓN DE PRINCIPALES DESVIACIONES (*)

Cipreses	Menor generación real por Cmg.
El Toro	Mayor generación real por control Cota Polcura.
Pehuenche	Mayor generación real por condición de vertimiento evitable.
Ventanas 2	Menor generación real por desconexión de curso forzoso por tubo roto de caldera.

$$(*) \text{ si } \left\{ \begin{array}{l} |E_{real} - E_{programada}| > 12.5\% E_{programada} \\ y \\ |E_{real} - E_{programada}| > 0.5\% E_{total \text{ real}} \end{array} \right\}$$

3. ESTADO DE LAS CENTRALES

3.1. Indisponibilidad por Falla

CENTRALES (100 MW)	Disponibilidad (%)	Observaciones
Alfalfal	50.0	U-1 indisponible por falla a tierra en el estator.
Chacayes	0.0	Indisponible por falla en canal de aducción.
La Confluencia	0.0	U-1 limitada a cero inyección por exceso de caudal y sedimentos.

3.2. Informe de Limitación de Unidades Generadoras

CENTRALES (100 MW)	Disponibilidad (%)	Observaciones
Antuco	100.0	Mínimo de 90 MW para mantener en servicio bombas de agua a entrega de riego.
Bocamina 2	97.0	Alta diferencial en eliminador de niebla y calentador de gas del desulfurizador.
Canutillar	31.0	Limitada por cota del embalse.
Guacolda 1	100.0	Limitada por tiempo de estabilización.
Guacolda 2	100.0	Limitada por tiempo de estabilización.
Guacolda 4	100.0	Limitada por tiempo de estabilización.
Guacolda 5	100.0	Limitada por tiempo de estabilización.
La Confluencia	0.0	U-1 limitada a cero inyección por exceso de caudal y sedimentos.
La Higuera	0.0	Central completa limitada a cero inyección por exceso de caudal y sedimentos.
Quintero Diésel	0.0	Limitada por exigencias ambientales.
Ralco	100.0	Limitada por control cota embalse (puede bajar máximo 25 cm/día).
San Isidro Diésel	0.0	Limitada en CA Diésel equipo de medición de material particulado PM10 no ha sido validado por la autoridad medio ambiental.
San Isidro II Diésel	0.0	Limitada en CA Diésel equipo de medición de material particulado PM10 no ha sido validado por la autoridad medio ambiental.
Santa María	95.0	Pérdida eficiencia de la turbina vapor.
Solar Luz del Norte	46.0	Limitada por indisponibilidad de los bloques 1 y 2 de generación.
Ventanas 1	81.0	Limitada por control de temperatura de descarga agua de mar.
Ventanas 2	25.0	Tubo roto de caldera.

3.3. Programa de Mantenimiento Mayor

CENTRALES (100 MW)	Disponibilidad (%)	Observaciones
Guacolda 3	0.0	U-3 con PMM y mantiene limitación por tiempo de estabilización.
Pehuenche	50.0	U-1 con PMM.
Rucúe	50.0	U-2 con PMM.

3.4. Solicitud de desconexión de curso forzoso

CENTRALES (100 MW)	Disponibilidad (%)	Observaciones
---------------------	--------------------	---------------

CENTRALES (100 MW)	Disponibilidad (%)	Observaciones
Ventanas 2	25.0	Tubo roto de caldera.

4. ANTECEDENTES DE LA OPERACIÓN DIARIA

4.1. Observaciones

Hora	Observación
00:00	C. Colbún U-1 regula frecuencia.
00:00	C. Ralco ratifica en condición de agotamiento.
00:00	Cs. Rapel y Pehuenche ratifican en condición de vertimiento evitable.
00:00	Cs. Alto Renaico, PFV Loma Los Colorados, Pulelfu PMG, PFV Carrera Pinto, CMPC Cordillera, Santa Marta U-9 y 10, Itata, PE Lebu (ampliación de 6,5 a 10 MW), CMPC Tissue , Andes Generación, Carilafquén, Malalcahuello, PFV Pampa Solar Norte, PE La Esperanza y PE Los Buenos Aires continúan en pruebas.
00:32	C. Curillinque sincronizada.
00:36	Chilectra SDAC deshabilitado.
01:00	C. Pehuenche Bocatoma Maule con solicitud de intervención de curso forzoso. Causa informada: Efectuar desripado.
02:00	C. Pehuenche Bocatoma Maule cancelada solicitud de intervención de curso forzoso.
03:15	C. El Paso U-1 sale del servicio en forma intempestiva con 20 MW.
03:51	C. El Paso U-1 sincronizada
04:25	C. El Paso U-1 sale del servicio en forma intempestiva con 20 MW.
05:00	C. El Paso U-1 sincronizada
05:52	C. Cholguán sale del servicio en forma intempestiva con 10,5 MW.
07:21	C. El Toro U-1 sincronizada y disponible.
09:58	C. Aconcagua unidad Blanco sale del servicio en forma intempestiva con 48 MW.
10:06	C. Puntilla con solicitud de curso forzoso. Causa informada: Aumento de afluentes y rejas de captación obstruidas por arrastre de ramas.
10:23	C. El Toro U-2 toma la regulación de frecuencia.
11:07	C. Ventanas 2 con solicitud de desconexión de curso forzoso. Causa informada: Tubo roto en la caldera.
11:30	C. Aconcagua unidad Blanco sincronizada.
11:35	Abierta línea de 220 kV Maitencillo - Cardones 2 para regular tensión.
11:37	C. Itata U-2 sincronizada en pruebas.
11:48	Inicio de prorrata por control de transferencia de línea de 220 kV Cardones - San Andrés.
11:50	C. Cholguán disponible y E/S.
11:50	Línea de 66 kV Portezuelo - Marchigüe con solicitud de desconexión de curso forzoso. Causa informada: Poda de árboles con riesgo para la línea entre estructuras 44 y 46.
12:09	Línea de 66 kV Portezuelo - Marchigüe cancelada solicitud de desconexión de curso forzoso.
12:13	Cerrada línea de 220 kV Ralco - Charrúa 1.
12:17	S/E Antuco sistema scada con solicitud de intervención de curso forzoso. Causa informada: Normalizar datos scada y telecontrol.
12:29	Cerrada línea de 220 kV Canutillar - P. Montt 2.
13:15	Línea de 66 kV Parral - Cauquenes con solicitud de intervención de curso forzoso. Causa informada: Poda de árboles con riesgo para la línea.
14:56	C. Colbún U-1 toma la regulación de frecuencia.
15:47	Línea de 66 kV Parral - Cauquenes cancelada solicitud de intervención de curso forzoso.
16:07	Lago Chapo llega a la cota 222.85 m.s.n.m., C. Canutillar puede generar 100 MW como máximo.
17:46	Línea de 220 kV Canutillar - Puerto Montt 1 abierta para regular tensión.
17:48	Finaliza prorrata por control de limitación de línea de 220 kV Cardones - Diego de Almagro.
18:20	C. Aconcagua unidad Blanco disponible y E/S.
18:54	Cerrada línea de 220 kV Cardones - Maitencillo 2.
19:09	C. Puntilla cancelada solicitud de desconexión de curso forzoso.
19:16	S/E Florida transformador de 110/12 kV 25 MVA interrupción forzada por protecciones, se pierden 7 MW de consumos.
19:16	Cs Florida 2 U-1 y Florida 3 U-1 y 2 salen del servicio en forma intempestiva con 5.6 y 1.1 MW respectivamente. Causa informada: Falla en transformador de 110/12 kV 25 MVA de S/E Florida.
19:29	S/E Florida normalizados los consumos.
20:35	S/E Florida transformador de 110/12 kV 25 MVA E/S.
21:25	Línea de 44 kV Catemu - Los Ángeles interrupción forzada por protecciones, afectando los consumos de S/E Los Ángeles se pierden 2 MW.
22:08	Línea de 44 kV Catemu - Los Ángeles reconexión manual sin éxito.
23:38	Cs Florida 2 sincronizada.

Hora	Observación
23:39	C. Nueva Renca limitada a 210 MW Causa informada: Alta diferencial en aire de entrada turbina T'G.
23:53	Línea de 44 kV Las Vegas - Los Andes 1 y 2 interrupción forzada por protecciones, afectando los consumos de las SS/EE Catemu, Panquehue y Chagres, con 6.5 MW interrumpidos.
23:53	S/E Las Vegas barra N° 2 de 44 kV interrupción forzada por protecciones, afectando los consumos de las SS/EE Entel, Caleu, Rungue y EFE Runque, con 1.1 MW interrumpidos.
23:57	C. Rucue U-2 cancela mantenimiento mayor, disponible y E/S.

4.2. Otras Observaciones

Observación
Frecuencia máxima y mínima registrada durante el día: 50,22 y 49,78 Hz.

4.3. Nuevas Instalaciones

Hora	Empresa	Instalación
19:23	Transelec	Extensión de barra de 500 kV sección 2.

5. INDISPONIBILIDAD SCADA

Empresa	Instalación	Fecha F/S	Hora F/S	Fecha E/S	Hora E/S
COLBUN	SS/EE Chagres, Calera Centro, Cerro Calera y Esperanza.	10/08/2010	14:30		
COYANCO	C. Guayacán datos scada P, Q y S de las unidades generadoras (señales no implementadas).	28/09/2015	12:13		
Transquillota	S/E San Luis datos scada.	29/10/2015	00:00		
Panguipulli S.A.	S/E Interconexión paño JL2 datos scada.	06/01/2016	09:22		
Cia. Minera Franke	S/E Diego de Almagro paño H7 datos scada.	06/01/2016	09:22		
SGA	C. Cementos Bio Bio datos scada	21/01/2016	07:15		
TRANSNET	SS/EE San Javier y Constitución dato scada de T° con indicación errónea.	09/02/2016	11:26		
Potencia	C. Olivos datos scada.	23/02/2016	11:45		
Tecnored	C. Linares Norte datos scada	16/03/2016	12:00		
Javiera SpA	C. PFV Javiera datos scada asociados a los paños de 23 kV.	24/03/2016	14:30		
TRANSNET	S/E Constitución datos scada asociados al transformador N° 1, frecuencia y tensión en barra 66 kV.	04/04/2016	07:15		
Energía Pacífico	C. Energía Pacífico datos scada.	05/04/2016	21:00		
ARAUCO	C. Horcones datos scada.	10/04/2016	08:35		
STS	C. Quellón 2 datos scada.	11/04/2016	10:53		
Transec	S/E Antuco datos scada y telecontrol.	14/04/2016	19:47		
ENDESA	C. Rapel datos scada y telecontrol.	15/04/2016	21:53	16/04/2016	10:30

6. COMUNICACIONES

Empresa	Instalación	Fecha F/S	Hora F/S	Fecha E/S	Hora E/S
GDFSUez	Hot-Line despacho principal F/S.	14/04/2016	00:00		

ANEXO N° 4
Detalle de mantenimientos programados y forzados correspondientes al día
16 de abril de 2016

Nro.	Empresa	Resumen	Tipo	Cuando	Objetivo	Fec.Ini.Prg	Hora Ini.Prg	Fec.Ter.Prg	Hora Ter.Prg	Fec.Ini.Efec	Hora Ini.Efec	Fec.Ter.Efec	Hora Ter.Efec
SD09151/2016	sts	Subestación : CARDONES_____220 Línea : D.ALMAGRO_____220 - CARDONES_____220 CTO1 Tramo : D.ALMAGRO_____220 - CARDONES_____220 CTO1 Intervención / Programada Ningún Consumo Afectado	Intervencion	Programada	Se solicita no reconectar línea 220 kV Cardones Diego de Almagro cto N°1, por trabajos de instalación de soportes, vestido, tendido, templado, engrampado y remates para nuevo cable OPGW	16/04/2016	08:00	16/04/2016	18:30	16/04/2016	08:14	16/04/2016	18:48
SD11654/2016	sts	Subestación : CARDONES_____220 Línea : D.ALMAGRO_____220 - CARDONES_____220 CTO1 Tramo : D.ALMAGRO_____220 - CARDONES_____220 CTO1 Intervención / Programada Ningún Consumo Afectado	Intervencion	Programada	Deshabilitar reconexión automática y no reconectar línea 220 kV Diego de Almagro - Cardones cto 1 por trabajos de lavado de aislación con agua a presión en T001 hasta T180 y T410 hasta T419.	16/04/2016	08:00	16/04/2016	16:00	16/04/2016	07:51	16/04/2016	16:17
SD12685/2016	duke	Central : YUNGAY / Unidad : U2 / Potencia Disponible : 0.0 MW Desconexión / Origen Interno / Programada Ningún Consumo Afectado	Desconexion	Programada	Se realizará Auditoria Técnica de la Unidad de acuerdo a recomendaciones del fabricante. El trabajo será ejecutado por la empresa PW Power Systems.	16/04/2016	06:00	20/04/2016	23:45	16/04/2016	08:08	20/04/2016	08:11
SD12830/2016	sts	Subestación : CARDONES_____220 Línea : D.ALMAGRO_____220 - CARDONES_____220 CTO1 Tramo : D.ALMAGRO_____220 - CARDONES_____220 CTO1 Intervención / Programada Ningún Consumo Afectado	Intervencion	Programada	Deshabilitar reconexión automática y no reconectar línea 220 kV Diego de Almagro - Cardones cto 1 por trabajos de tendido de conductores entre Torre 237-1 a ML paños J5 y J6 de SE Carrera Pinto, para seccionamiento de línea de transmisión Cardones - Diego de Almagro.	16/04/2016	08:00	16/04/2016	18:30	16/04/2016	08:14	16/04/2016	18:48

Número	Tipo	Empresa	Tipo Solicitud	Origen	Tipo Programación	Línea	Tramo	Tipo Trabajo	Comentario	Fecha Inicio	Fecha Fin	Fecha Efectiva Inicio	Fecha Efectiva Fin
2909	Línea	TRANSNET	Intervención	Origen Interno	Curso Forzoso	PARRAL - CAUQUENES 66KV	PARRAL - CAUQUENES 66KV C1,	Otro Tipo de Trabajo	Tala de emergencia de árboles con proyección hacia la línea. Requiere inhabilitar reconexión automática de la línea.	16/04/2016 13:12:00	16/04/2016 20:00:00	16/04/2016 13:15:00	16/04/2016 15:47:00
2904	Línea	TRANSNET	Intervención	Origen Interno	Curso Forzoso	PORTEZUELO - MARCHIGUE 66KV	PORTEZUELO - MARCHIGUE 66KV C1,	Otro Tipo de Trabajo	Tala de árboles en franja de seguridad con ramas cercanas a Línea de 66 kV. Se requiere inhabilitar reconexión automática de la línea.	16/04/2016 12:29:00	16/04/2016 14:00:00	16/04/2016 12:32:00	16/04/2016 12:47:00
2902	Línea	TRANSNET	Desconexión	Origen Interno	Curso Forzoso	PORTEZUELO - MARCHIGUE 66KV	PORTEZUELO - MARCHIGUE 66KV C1,	Otro Tipo de Trabajo	Poda de emergencia de árboles con ramas cercanas a línea entre estructuras 44 y 46 desplazadas por efecto de la lluvia, con riesgo de descarga. Considera realizar microcorte para su poda, afectando consumos de Subestaciones Marchigue, Alcones y Lihueimo.	16/04/2016 11:50:00	16/04/2016 11:53:00	16/04/2016 11:50:00	16/04/2016 12:09:00
2536	Línea	TRANSNET	Intervención	Origen Interno	Programada	CERRILLOS - LOS LOROS 110KV	CERRILLOS - LOS LOROS 110KV C1,	Otro Tipo de Trabajo	Se realiza reemplazo de poste de E90 con las instalaciones en servicio, para lo cual se requiere el bloqueo de reconexión del 52HZ de SE Carrillos. Condición que se mantendrá durante la ejecución efectiva de los trabajos.	16/04/2016 08:00:00	16/04/2016 20:00:00	16/04/2016 09:55:00	16/04/2016 15:51:00
2449	Línea	CHILECTRA	Desconexión	Origen Interno	Programada	METRO - LORD COCHRANE 110KV	METRO - LORD COCHRANE 110KV C1,	Otro Tipo de Trabajo	Desconexión de cable Metro - Lord Cochrane - Ochagavía para mantenimiento de equipos en S/E Metro	16/04/2016 00:00:00	16/04/2016 07:00:00	15/04/2016 23:42:00	16/04/2016 04:45:00
2448	Línea	CHILECTRA	Desconexión	Origen Interno	Programada	LORD COCHRANE - OCHAGAVIA 110KV	LORD COCHRANE - OCHAGAVIA 110KV C1,	Otro Tipo de Trabajo	Desconexión de cable Metro - Lord Cochrane - Ochagavía para mantenimiento de equipos en S/E Metro	16/04/2016 00:00:00	16/04/2016 07:00:00	15/04/2016 23:42:00	16/04/2016 04:45:00
1796	Línea	TRANSELEC	Intervención	Origen Interno	Programada	ANTUCO - CHARRUA - PANGUE 220KV	TRUPAN - TAP CHOLGUAN 220KV C2,PANGUE - SANTA BARBARA 220KV C2,TAP CHOLGUAN - CHARRUA 220KV C2,	Otro Tipo de Trabajo	Equipo:LÍNEA 220 kV PANGUE - CHARRUA, CIRCUITO --- Tipo Trabajo:Lavado de Aislación --- Descripción del Trabajo --- Lavado de aislación --- Restricciones:Restricción a la reconexión --- Nivel Riesgo:Bajo --- Bloqueo del Jefe de Faenas --- no hay --- Instalaciones con riesgo --- LÍNEA 154 kV ABANICO - CHARRUA O LÍNEA 220 kV PANGUE - CHARRUA --- (Durante la faena) --- Observaciones --- No reconectar los interruptores asociados a la línea. ---	16/04/2016 11:00:00	16/04/2016 13:00:00	16/04/2016 11:31:00	16/04/2016 12:38:00
1795	Línea	TRANSELEC	Intervención	Origen Interno	Programada	CHARRUA - CONCEPCION 220KV	CHARRUA - CONCEPCION 220KV C1,	Otro Tipo de Trabajo	Equipo:LÍNEA 220 kV CHARRUA - CONCEPCION --- Tipo Trabajo:Lavado de Aislación --- Descripción del Trabajo --- Lavado de aislación. --- Restricciones:Restricción a la reconexión --- Nivel Riesgo:Bajo --- Bloqueo del Jefe de Faenas --- no hay --- Instalaciones con riesgo --- LÍNEA 220 kV CHARRUA - CONCEPCION (Durante la faena) --- Observaciones --- No reconectar los interruptores asociados a la línea. ---	16/04/2016 14:00:00	16/04/2016 17:00:00	16/04/2016 11:31:00	16/04/2016 16:38:00
1783	Línea	TRANSELEC	Intervención	Origen Interno	Programada	ABANICO - CHARRUA 154KV	TRUPAN - CHARRUA 154KV C1,ABANICO - TRUPAN 154KV C1,ABANICO - TRUPAN 154KV C2,	Otro Tipo de Trabajo	Equipo:LÍNEA 154 kV ABANICO - CHARRUA --- Tipo Trabajo:Lavado de Aislación --- Descripción del Trabajo --- Lavado de aislación. --- Restricciones:Restricción a la reconexión --- Nivel Riesgo:Bajo --- Bloqueo del Jefe de Faenas --- no hay --- Instalaciones con riesgo --- LÍNEA 154 kV ABANICO - CHARRUA O LÍNEA 220 kV PANGUE - CHARRUA --- (Durante la faena) --- Observaciones --- No reconectar los interruptores asociados a la línea. ---	16/04/2016 11:00:00	16/04/2016 13:00:00	16/04/2016 11:31:00	16/04/2016 12:38:00
1782	Línea	TRANSELEC	Intervención	Origen Interno	Programada	CHARRUA - DUQUECO 220KV	CHARRUA - TAP EL ROSAL 220KV C1,TAP EL ROSAL - DUQUECO 220KV C1,	Otro Tipo de Trabajo	Equipo:L. 220 KV CHARRUA - DUQUECO --- Tipo Trabajo:Lavado de Aislación --- Descripción del Trabajo --- Lavado de aislación --- Restricciones:Restricción a la reconexión --- Nivel Riesgo:Bajo --- Bloqueo del Jefe de Faenas --- no hay --- Instalaciones con riesgo --- L. 220 KV CHARRUA - DUQUECO (Durante la faena) --- Observaciones --- No reconectar los interruptores asociados a la línea. ---	16/04/2016 08:00:00	16/04/2016 10:00:00	16/04/2016 08:22:00	16/04/2016 10:05:00
1614	Línea	TRANSELEC	Intervención	Origen Interno	Programada	ALTO JAHUEL - POLPAICO 500KV	EL RODEO - POLPAICO 500KV C2,ALTO JAHUEL - EL RODEO 500KV C2,	Otro Tipo de Trabajo	Equipo:S/E Polpaico. Int. 52K1 (transferido). --- Tipo Trabajo:Obras por Decreto --- Descripción del Trabajo --- S/E Polpaico: Por trabajos de instalación de puentes por ampliación --- Barra 2 de 500 kV se transfiriere interruptor 52K1 a Barra de 500 kV --- Sección 1. --- Restricciones:Interruptor transferido --- Nivel Riesgo:Bajo --- Bloqueo del Jefe de Faenas --- Delimitación y señalización zona de trabajo. --- Instalaciones con riesgo --- Línea de 500 kV Alto Jahuel - Polpaico 2. --- Observaciones --- Para los trabajos de cierre de puentes de ampliación Barra 2 de 500 --- kV, se requiere interruptor 52K1 (Alto Jahuel 2) transferido a Barra 1 --- por distancia eléctrica a punto de trabajo. ---	16/04/2016 00:00:00	16/04/2016 18:00:00	16/04/2016 00:08:00	16/04/2016 19:23:00

Número	Tipo	Empresa	Tipo Solicitud	Origen	Tipo Programación	Línea	Tramo	Tipo Trabajo	Comentario	Fecha Inicio	Fecha Fin	Fecha Efectiva Inicio	Fecha Efectiva Fin
2908	Central Generadora	PUNTILLA	Desconexión	Origen Externo	Curso Forzoso	PUNTILLA	PUNTILLA U2	Otro Tipo de Trabajo	Central Puntilla queda fuera de servicio por alud en la cordillera, lo que trae como consecuencia mucha basura en los canales.	16/04/2016 10:06:00	17/04/2016 23:59:00	16/04/2016 10:06:00	16/04/2016 19:09:00
2907	Central Generadora	PUNTILLA	Desconexión	Origen Externo	Curso Forzoso	PUNTILLA	PUNTILLA U3	Otro Tipo de Trabajo	Central Puntilla queda fuera de servicio por alud en la cordillera, lo que trae como consecuencia mucha basura en los canales.	16/04/2016 09:38:00	17/04/2016 23:59:00	16/04/2016 10:06:00	16/04/2016 19:06:00
2906	Central Generadora	IES GENER	Desconexión	Origen Interno	Curso Forzoso	VENTANAS 2	VENTANAS 2	Otro Tipo de Trabajo	Sale de servicio para reparar tubo roto de caldera.	16/04/2016 11:07:00	18/04/2016 23:59:00	16/04/2016 11:07:00	20/04/2016 22:56:00
2905	Central Generadora	IES GENER	Desconexión	Origen Interno	Curso Forzoso	VENTANAS 1	VENTANAS 1	Otro Tipo de Trabajo	Se retira de servicio para reparar tubo roto de caldera.	16/04/2016 11:07:00	18/04/2016 23:59:00	16/04/2016 00:00:00	16/04/2016 00:01:00
2560	Central Generadora	ENDESA	Desconexión	Origen Interno	Programada	BOCAMINA II	CENTRAL COMPLETA	Otro Tipo de Trabajo	Obstrucción parcial del eliminador de Niebla y el precalentador Gas Gas del desulfurizador, se requiere lavado con central fuera de servicio para evitar daños en el equipo. Reposición de mangas en Filtro de Mangas 10 y 20	16/04/2016 00:00:00	17/04/2016 23:59:00	16/04/2016 00:00:00	19/04/2016 00:00:00
2500	Central Generadora	PV SALVADOR	Desconexión	Origen Interno	Programada	PV SALVADOR	CENTRAL COMPLETA	Otro Tipo de Trabajo	Se realizara Revision de Funcionamiento de Desconector Principal Sistema Stow	16/04/2016 21:00:00	17/04/2016 06:00:00	16/04/2016 21:52:00	17/04/2016 00:38:00
1702	Central Generadora	NUEVA DEGAN	Intervención	Origen Interno	Programada	DEGAÑ	CENTRAL COMPLETA	Otro Tipo de Trabajo	Pruebas de control, regulación y carga en equipos, se pretende llegar a 36 MW	16/04/2016 08:00:00	16/04/2016 18:00:00	16/04/2016 09:56:00	
1290	Central Generadora	SAGESA	Desconexión	Origen Interno	Programada	CORONEL	CORONEL TG	Otro Tipo de Trabajo	Boroscofia a la turbina y limpieza de compresor mediante lavado.	16/04/2016 02:00:00	16/04/2016 18:00:00	16/04/2016 02:04:00	16/04/2016 15:56:00

Número	Tipo	Empresa	Tipo Solicitud	Origen	Tipo Programación	Línea	Tramo	Tipo Trabajo	Comentario	Fecha Inicio	Fecha Fin	Fecha Efectiva Inicio	Fecha Efectiva Fin
2903	Subestación	TRANSELEC	Intervención	Origen Interno	Curso Forzoso	S/E ANTUCO (TRANSELEC)		Otro Tipo de Trabajo	Equipo:SISTEMA SCADA - C.ANTUCO --- Tipo Trabajo:Investigar o Reparar Anormalidad --- Descripción del Trabajo --- S/E Antuco: Debido a anomalía en URT de Antuco se requiere --- desalambrar los módulos fallados y alambros los módulos nuevos. Se --- realizarán pruebas. --- Restricciones:Normalización sujeta a coordinación --- Nivel Riesgo:Bajo --- Bloqueo del Jefe de Faenas --- Se maniobrará el Switch Local Remoto de la Subestación Antuco. --- Instalaciones con riesgo --- S/E. GS - ANTUCO. DURANTE LA FAENA --- Observaciones --- TRABAJOS NECESARIOS PARA RECUPERAR LA URT DE ANTUCO ---	16/04/2016 08:00:00	22/04/2016 18:00:00	16/04/2016 12:17:00	20/04/2016 14:11:00
2868	Subestación	TRANSELEC	Desconexión	Origen Interno	Curso Forzoso	S/E ALTO JAHUEL	BA S/E ALTO JAHUEL 154KV,	Otro Tipo de Trabajo	Equipo:BARRA 154 KV - ALTO JAHUEL --- Tipo Trabajo:Reparar Anormalidad --- Descripción del Trabajo --- S/E Alto Jahuel: Reparación de punto caliente en desconector 89AT6-1 --- Fase 1, 2 y 3 (Contactos principales). --- Restricciones:Equipo Indisponible --- Nivel Riesgo:Bajo --- Prueba Exp. Sin prueba Experimental --- Bloqueo del Jefe de Faenas --- S/E Alto Jahuel: Delimitación de la zona de trabajo, puestas a tierra --- a ambos lados de desconector 89AT6-1 --- Instalaciones con Riesgo --- S/E Alto Jahuel: Barra de 154 kV en la etapa de conexión al servicio) --- Observaciones --- No hay ---	16/04/2016 00:00:00	16/04/2016 04:00:00	20/04/2016 00:41:00	20/04/2016 04:04:00
2454	Subestación	METRO	Desconexión	Origen Externo	Programada	S/E METRO	METRO 110/20KV 40MVA 1,	Otro Tipo de Trabajo	Mantenimiento a equipos de 110 kv. lado Ochagavía: Seccionador de Línea, Interruptor y transformador de 40 MVA. Se necesita TR1, fuera de servicio.	16/04/2016 00:25:00	16/04/2016 06:00:00	16/04/2016 00:33:00	16/04/2016 04:40:00
2008	Subestación	STS	Intervención	Origen Externo	Programada	S/E CHOLGUAN (STS)	S/E CHOLGUAN JT1,	Lavado de Aislación	NO reconectar 52JT1 a solicitud de Transelec por lavado de aislación en línea Pangue - Charrúa 220 kv	16/04/2016 11:00:00	16/04/2016 13:00:00	16/04/2016 11:36:00	16/04/2016 12:57:00
1897	Subestación	HIDROELECTRICA LA HIGUERA	Desconexión	Origen Interno	Programada	S/E LA HIGUERA	S/E LA HIGUERA A5,	Otro Tipo de Trabajo	Desconexión de la línea de 154kv La Higuera - Tinguiririca Circuito N°2, según SD 1582/2016 de Transelec. por trabajos de mantenimiento equipos primarios en S/E Tinguiririca	16/04/2016 09:00:00	16/04/2016 18:00:00	16/04/2016 08:26:00	16/04/2016 16:56:00
1818	Subestación	TRANSNET	Intervención	Origen Externo	Programada	S/E DUQUECO	S/E DUQUECO J1,	Lavado de Aislación	A solicitud de TRANSELEC de acuerdo a SODI 172, NO reconectar 52J1 de S/E Duqueco por faenas en instalaciones de TRANSELEC.	16/04/2016 08:00:00	16/04/2016 10:00:00	16/04/2016 08:25:00	16/04/2016 10:03:00
1764	Subestación	TRANSELEC	Intervención	Origen Interno	Programada	S/E DIEGO DE ALMAGRO	SVC PLUS S/E DIEGO DE ALMAGRO JT6 13.9KV 140 MVAR,	Otro Tipo de Trabajo	Equipo:SVC PLUS - DDA --- Tipo Trabajo:Solicitado por Terceros --- Descripción del Trabajo --- S/E Diego de Almagro, a solicitud de CDEC-SIC, se realizaron ensayos y --- medidas de parámetros eléctricos en circuitos secundarios del --- equipo SVC Plus para estudio de representación dinámica SIC. --- Restricciones:Normalización sujeta a coordinación --- Nivel Riesgo:Bajo --- Bloqueo del Jefe de Faenas --- S/E D. Almagro, Switch LOCAL/REMOTO de SVC Plus de Diego a disposición del jefe de faena --- Instalaciones con riesgo --- SVC PLUS - DIEGO DE ALMAGRO --- Observaciones --- No Hay ---	16/04/2016 08:00:00	16/04/2016 18:00:00	16/04/2016 08:28:00	16/04/2016 16:31:00
1602	Subestación	TRANSELEC	Desconexión	Origen Interno	Programada	S/E TINGUIRIRICA	S/E TINGUIRIRICA A5,	Otro Tipo de Trabajo	Equipo:S/E Tinguiririca: PAÑO A5, LA HIGUERA 2 --- Tipo Trabajo:Mantenimiento de Equipos Primarios --- Descripción del Trabajo --- S/E Tinguiririca: Mantenimiento Preventivo normal a desconectores --- 89A5-2, 89A5-2T y 89A5-3. Mantenimiento correctivo y reemplazo de cuenta --- descargas en pararrayos de paño A5. Reemplazo de letreros de indicación --- de línea y fases. Modificación de puente en Barra auxiliar de Paño A5 --- Restricciones:Equipo Indisponible --- Nivel Riesgo:Bajo --- Prueba Exp. Sin prueba Experimental --- Bloqueo del Jefe de Faenas --- S/E Tinguiririca: --- Delimitación de la zona de Trabajo --- Instalación de tierras provisionales de Bloqueo en Equipos del Paño --- A5 --- Instalaciones con Riesgo --- BARRA 154 kv, SECCION 2 S/E TINGUIRIRICA (Al inicio y al término de la --- faena) --- Observaciones --- S/E Tinguiririca: Programa de Mantenimiento de Equipos Primarios. --- Nota: Desconexión de Línea 154 kv La Higuera-Tinguiririca 2 --- coordinada con Tinguiririca Energía ---	16/04/2016 09:00:00	16/04/2016 18:00:00	16/04/2016 08:18:00	16/04/2016 16:56:00
1561	Subestación	TRANSELEC	Desconexión	Origen Interno	Programada	S/E POLPAICO	BA S/E POLPAICO 500KV SECCION B,	Otro Tipo de Trabajo	Equipo:S/E Polpaico. Barra de 500 kv Sección 2. --- Tipo Trabajo:Obras por Decreto --- Descripción del Trabajo --- S/E Polpaico: Instalación de puentes de alta tensión entre extensión de --- Barra Principal sección 2 de 500 kv y marco de barra existente (obra del --- decreto 310/2013). --- Restricciones:Equipo Indisponible --- Nivel Riesgo:Bajo --- Prueba Exp. Sin prueba Experimental --- Bloqueo del Jefe de Faenas --- S/E Polpaico: Delimitación de la zona de trabajo. Verificación de --- ausencia de tensión e instalación de puestas a tierra provisionales en --- Barra de 500 kv Sección 2. --- Instalaciones con Riesgo --- Línea de 500 kv Alto Jahuel - Polpaico 2. --- Observaciones --- S/E Polpaico: Previo a la desconexión de la Barra, se transfirió paño --- K1 (Alto Jahuel 2) a Barra de 500 kv Sección 1 y se traspanan todos --- los alimentadores a la Barra de 500 kv Sección 1. ---	16/04/2016 00:00:00	16/04/2016 18:00:00	16/04/2016 00:08:00	16/04/2016 19:23:00

Número	Tipo	Empresa	Tipo Solicitud	Origen	Tipo Programación	Línea	Tramo	Tipo Trabajo	Comentario	Fecha Inicio	Fecha Fin	Fecha Efectiva Inicio	Fecha Efectiva Fin
1271	Subestación	TRANSELEC	Desconexión	Origen Interno	Programada	S/E TINGUIRIRICA	BA S/E TINGUIRIRICA 154KV BARRA TRANSFERENCIA,	Otro Tipo de Trabajo	Equipo:S/E Tinguiririca: BARRA DE TRANSFERENCIA --- Tipo Trabajo:Mantenimiento de Equipos Primarios --- Descripción del Trabajo --- S/E Tinguiririca: Mantenimiento preventivo normal a desconector 89A5-3 --- con desconexión de Línea 154 kV La Higuera-Tinguiririca, circuito 2 --- Restricciones:Equipo Indisponible --- Nivel Riesgo:Bajo --- Prueba Exp.:Sin prueba Experimental --- Bloqueo del Jefe de Faenas --- S/E Tinguiririca: --- Delimitación de la zona de Trabajo --- Instalación de tierras provisionales de Bloqueo en 89A5-3 --- Instalaciones con Riesgo --- BARRA 154 kV , SECCION 2 S/E TINGUIRIRICA (Al inicio y término de la --- faena) --- Observaciones --- S/E Tinguiririca: Programa de Mantenimiento de Equipos Primarios. --- Nota: Desconexión de Línea 154 kV La Higuera-Tinguiririca 2 --- coordinada con Tinguiririca Energia --- ---	16/04/2016 09:00:00	16/04/2016 18:00:00	16/04/2016 08:18:00	16/04/2016 16:56:00

ANEXO N° 5
Informes de trabajos y fallas de instalaciones ingresados en el sistema
CDEC por Eléctrica Puntilla S.A.

 Resumen**Número:**

1154

Solicitante:

Francisco Rodriguez Rojas

Empresa:

PUNTILLA

Tipo de Origen:

Interno

Central:

FLORIDA II

Potencia:

Desconexión de la unidad(es)

Unidades:

Nombre :FLORIDA II 2

Potencia :5.6MW

Fecha Perturbacion :16/04/2016 19:16

Fecha Normaliza :16/04/2016 23:38

Protección :

Interruptor :52G2

Consumo :

Comentario :

Zona Afectada

Metropolitana

Comuna

La Florida

Tipo Causa

Causa Presunta

Causa Secundaria

Falla en barra

Comentarios Tipo Causa:

Desconexión intempestiva de la unidad por operación de protecciones. Causa En estudio

Causas**-Fenómeno Físico:** Origen no determinado (trip de interruptor)**-Elemento:** Equipo generador**-Fenómeno Eléctrico:** Bajo voltaje**-Operación de los interruptores:** Opera según lo esperado**Comentarios Causas:****-Fenómeno Físico:**

-Elemento:**-Fenómeno Eléctrico:****-Operación de los interruptores:****Observaciones:****-Observaciones:** Apertura de barra 12 Kv Central Florida**-Acciones Inmediatas:** Normalización de barra**-Hechos Sucridos:** Desconexión intempestiva de la unidad por operación de protecciones**-Acciones Correctivas a Corto Plazo:** Inspeccion de barra 12 Kv**-Acciones Correctivas a Largo Plazo:** Pendientes a analisis de protecciones**Consumo:**

Consumo Regulado

Distribuidoras Afectadas

CHILECTRA/ Perd. Estm. de Potencia:9/ Región :Metropolitana

Retorno Automatico:

No Tiene Retorno Automático

Estado Operativo:

DF (Desconexión Forzada)

Estado Operativo Efectivo:

DF (Desconexión Forzada)

Fechas / Horas Perturbación de la Solicitud:

16/04/2016 19:19

Fechas / Horas Estimadas Retorno:

16/04/2016 23:38

Fechas / Horas Efectiva Retorno:

16/04/2016 23:38

 Archivos Subidos**Archivo**

 IF N009 Barra F2 16-04-2016 19-16_RevA (002).pdf (/informe_fallas/download_file/571537c447e6c6385da3f013/IF N009 Barra F2 16-04-2016 19-16_RevA (002).pdf)

 BACK-UP RELES DE PROTECCION.zip (/informe_fallas/download_file/571537c447e6c6385da3f013/BACK-UP RELES DE PROTECCION.zip)

 Anexo.zip (/informe_fallas/download_file/571537c447e6c6385da3f013/Anexo.zip)

Versio

 Resumen**Número:**

1155

Solicitante:

Francisco Rodriguez Rojas

Empresa:

PUNTILLA

Tipo de Origen:

Interno

SubEstación:

S/E FLORIDA 2 (SCM)

Falla Sobre:

transformador

Elementos

Tipo: transformadores2d - FLORIDA 110/12.5KV 25MVA

Nombre : FLORIDA 110/12.5KV 25MVA

Fecha Perturbacion : 16/04/2016 19:16

Fecha Normaliza : 16/04/2016 20:35

Protección : Sobre Corriente

Interruptor : 52T

Consumo : 2.3 Mw

Comentario : .

Zona Afectada

Metropolitana

Comuna

La Florida

Tipo Causa

Causa Presunta

Causa Secundaria

Falla en barra

Comentarios Tipo Causa:

Desconexión intempestiva por operación de protecciones. Causa En estudio

Causas**-Fenómeno Físico:** Origen no determinado (trip de interruptor)**-Elemento:** Interruptores**-Fenómeno Eléctrico:** Sobrecorriente instantánea de fase**-Operación de los interruptores:** Opera según lo esperado**Comentarios Causas:****-Fenómeno Físico:**

-Elemento:**-Fenómeno Eléctrico:****-Operación de los interruptores:****Observaciones:****-Observaciones:** Apertura de barra 12 Kv Central Florida**-Acciones Inmediatas:** Normalización de barra**-Hechos Succedidos:** Desconexión intempestiva por operación de protecciones**-Acciones Correctivas a Corto Plazo:** Inspeccion de barra 12 Kv**-Acciones Correctivas a Largo Plazo:** Pendientes a análisis de protecciones**Consumo:**

Consumo Regulado

Distribuidoras Afectadas

CHILECTRA / Perd. Estm. de Potencia: 9 / Región : Metropolitana

Retorno Automatico:

No Tiene Retorno Automático

Fechas / Horas Perturbación de la Solicitud:



16/04/2016 19:16

Fechas / Horas Estimadas Retorno:

18/04/2016 18:46

Fechas / Horas Efectiva Retorno:

16/04/2016 20:35

 Archivos Subidos**Archivo** IF N009 Barra F2 16-04-2016 19-16_RevA (002).pdf (/informe_fallas/download_file/5715518047e6c6385da3f01e/IF N009 Barra F2 16-04-2016 19-16_RevA (002).pdf) Anexo.zip (/informe_fallas/download_file/5715518047e6c6385da3f01e/Anexo.zip) BACK-UP RELES DE PROTECCION.zip (/informe_fallas/download_file/5715518047e6c6385da3f01e/BACK-UP RELES DE PROTECCION.zip)**Versio**

 Resumen**Número:**

1156

Solicitante:

Francisco Rodriguez Rojas

Empresa:

PUNTILLA

Tipo de Origen:

Interno

Central:

FLORIDA III

Afecta a todas las unidades**Potencia:**

Desconexión de la unidad(es)

Unidades:**Zona Afectada**

Metropolitana

Comuna

La Florida

Tipo Causa

Causa Presunta
Causa Secundaria
Falla en barra

Comentarios Tipo Causa:

Desconexión intempestiva de la unidad por operación de protecciones. Causa en estudio

Causas

-Fenómeno Físico: Origen no determinado (trip de interruptor)
-Elemento: Equipo generador
-Fenómeno Eléctrico: Bajo voltaje
-Operación de los interruptores: Opera según lo esperado

Comentarios Causas:

-Fenómeno Físico:
-Elemento:
-Fenómeno Eléctrico:
-Operación de los interruptores:

Observaciones:

-Observaciones: Apertura de barra 12 Kv Central Florida
-Acciones Inmediatas: Normalización de barra
-Hechos Sucridos: Desconexión intempestiva de la unidad por operación de protecciones

-Acciones Correctivas a Corto Plazo: Inspeccion de barra 12 Kv

-Acciones Correctivas a Largo Plazo: Pendientes a análisis de protecciones

Consumo:

Consumo Regulado

Distribuidoras Afectadas

CHILECTRA/ Perd. Estm. de Potencia:9/ Región :Metropolitana

Retorno Automatico:

No Tiene Retorno Automático

Estado Operativo:

DF (Desconexión Forzada)

Estado Operativo Efectivo:

DF (Desconexión Forzada)

Fechas / Horas Perturbación de la Solicitud:

16/04/2016 19:16

Fechas / Horas Estimadas Retorno:

16/04/2016 21:00

Fechas / Horas Efectiva Retorno:

16/04/2016 23:38

 Archivos Subidos

Archivo

 IF N009 Barra F2 16-04-2016 19-16_RevA (002).pdf (/informe_fallas/download_file/571553bf47e6c6385b6ac723/IF N009 Barra F2 16-04-2016 19-16_RevA (002).pdf)

 Anexo.zip (/informe_fallas/download_file/571553bf47e6c6385b6ac723/Anexo.zip)

 BACK-UP RELES DE PROTECCION.zip (/informe_fallas/download_file/571553bf47e6c6385b6ac723/BACK-UP RELES DE PROTECCION.zip)

 Resumen**Número:**

1157

Solicitante:

Francisco Rodriguez Rojas

Empresa:

PUNTILLA

Tipo de Origen:

Interno

Central:

EL RINCON

Afecta a todas las unidades**Potencia:**

Desconexión de la unidad(es)

Unidades:**Zona Afectada**

Metropolitana

Comuna

La Florida

Tipo Causa

Causa Presunta

Causa Secundaria

Baja tensión en subestación

Comentarios Tipo Causa:

Desconexión intempestiva de la unidad por operación de protecciones. Causa En estudio

Causas**-Fenómeno Físico:** Origen no determinado (trip de interruptor)**-Elemento:** Equipo generador**-Fenómeno Eléctrico:** Bajo voltaje**-Operación de los interruptores:** Opera según lo esperado**Comentarios Causas:****-Fenómeno Físico:****-Elemento:****-Fenómeno Eléctrico:****-Operación de los interruptores:****Observaciones:****-Observaciones:** Apertura de barra 12 Kv Central Florida**-Acciones Inmediatas:** Normalización de barra**-Hechos Sucridos:** Desconexión intempestiva de la unidad por operación de protecciones

-Acciones Correctivas a Corto Plazo: Inspeccion de barra 12 Kv

-Acciones Correctivas a Largo Plazo: Pendientes a analisis de protecciones

Consumo:

Consumo Regulado

Distribuidoras Afectadas

CHILECTRA/ Perd. Estm. de Potencia:9/ Región :Metropolitana

Retorno Automatico:

No Tiene Retorno Automático

Estado Operativo:

DF (Desconexión Forzada)

Estado Operativo Efectivo:

DF (Desconexión Forzada)

Fechas / Horas Perturbación de la Solicitud:

16/04/2016 19:16

Fechas / Horas Estimadas Retorno:

16/04/2016 21:00

Fechas / Horas Efectiva Retorno:

16/04/2016 20:35

 Archivos Subidos

Archivo

 IF N009 Barra F2 16-04-2016 19-16_RevA (002).pdf (/informe_fallas/download_file/5715561747e6c6385da3f01f/IF N009 Barra F2 16-04-2016 19-16_RevA (002).pdf)

 Anexo.zip (/informe_fallas/download_file/5715561747e6c6385da3f01f/Anexo.zip)

 BACK-UP RELES DE PROTECCION.zip (/informe_fallas/download_file/5715561747e6c6385da3f01f/BACK-UP RELES DE PROTECCION.zip)

ANEXO N° 6
Otros antecedentes aportados por Eléctrica Puntilla S.A.

INFORME DE FALLA
REQUERIMIENTO NT de SyCS.

IF-C.Florida 2 N° 009

CONTENIDO:

1. Título.
2. Fecha y hora de inicio de la falla.
3. Condiciones de operación de las instalaciones previas a la perturbación.
4. Descripción y origen de la desconexión.
 - Fenómeno físico
 - Elemento
 - Fenómeno eléctrico
 - Modo
 - Origen (Interno o Externo).
 - Código de la falla.
 - Unidad o equipo afectado.
 - Potencia instantánea previa a la falla.
 - Potencia instantánea posterior a la falla.
5. Diagrama simplificado de conexión al sistema.
6. Protecciones operadas.
7. Setting de protecciones y Oscilografías.
8. Secuencia de maniobras.
9. Otros hechos relevantes para la operación.
 - Fecha de conexión.
 - Hora de conexión.
 - Tiempo de desconexión.
 - Pérdida de generación (MW).
10. Observaciones generales.
11. Nombre de quien elabora el informe.

Complejo Florida

1. TITULO:

Desconexión Intempestiva de Barra 12 kV Central Florida 2, Sábado 16-04-2016

2. FECHA Y HORA DE INICIO DE LA FALLA:

Fecha : sábado, 16 de abril de 2016

Hora : 19:16 hrs.

3. CONDICIONES DE OPERACIÓN DE LAS INSTALACIONES PREVIAS A LA PERTURBACIÓN:

Previo a la condición de falla de la barra de 12 kV de Central florida 2, ésta se encontraba en servicio normal, con los aportes y cargas descritos a continuación:

- Central Florida 1
 - Unidad N°3: F/S Por bajo caudal.
 - Unidad N°5: F/S Por bajo caudal.
- Central Florida 2
 - Unidad N°1: 6.5 MW.
 - Unidad N°2: F/S Por bajo caudal.
- Central Florida 3
 - Unidad N°1: 1.1 MW.
 - Unidad N°2: 1.1 MW.
- Central El Rincón
 - Unidad N°1: 0.21 MW.
- Alimentador Rojas Magallanes: 4.7 MW.
- Alimentador Corporación: 2.7 MW.
- Alimentador Canelo: 0.0 MW.

4. DESCRIPCIÓN Y ORIGEN DE LA DESCONEXIÓN:

La desconexión de la barra de 12 kV de Central Florida 2 se debió a la operación de las protecciones del transformador de poder 110/12 kV, debido a ocurrencia de una falla de origen interno, en el Switchgear de 12 kV en Central Florida 1.

Previo a la condición de falla, las Centrales Florida 1, Centrales Florida 2, Centrales Florida 3 y Central Rincón se encontraban operando en forma normal, cuando a las 19:16 hrs del día sábado 16-04-2016 ocurre una falla en el switchgear de la Central Florida 1, siendo del tipo de falla trifásica (según lo observado en las oscilografías).

La protección 7SJ del alimentador Florida 1, que ordena el desenganche del interruptor correspondiente, es lo que finalmente determina la aislación de la falla ocurrida en el Switchgear de Central Florida 1 en 12 kV.

La protección 7SJ del alimentador Florida 1, ordena el desenganche del interruptor correspondiente, que finalmente determina la aislación de la falla ocurrida en el Switchgear de Central Florida 1 en 12 kV.

A su vez la falla fue detectada por las protecciones asociadas al transformador 110/12kV de la Central Florida 2, donde la protección 7SJ del transformador tuvo arranques por sobrecorriente de fase, pero no tuvo orden de desenganche, ya que la protección cuenta con tiempo de paso ante fallas aguas debajo de esta.

En cambio la protección 7UT del transformador, tuvo operación de sus funciones de protección con salida disparando sobre el relé maestro 86T, que ordena el desenganche simultáneo de los interruptores de 12 kV y 110 kV del transformador de poder N° 1 de S/E Florida. Lamentablemente, no se cuenta con registro del evento en la protección 7UT, ya que este fue borrado inadvertidamente al extraer la data del relé.

El día lunes 18-04-2016, hubo otra falla en el mismo punto, switchgear de 12kV de la Central Florida 1, por lo cual se realiza análisis de las oscilografías del relé 7SJ del transformador, para las dos fallas registradas, encontrando que el comportamiento de las variables ante las dos fallas son idénticos y se registran arranques de las mismas funciones de protección, tal como se muestra a continuación:

Falla Sábado 16-04-2016

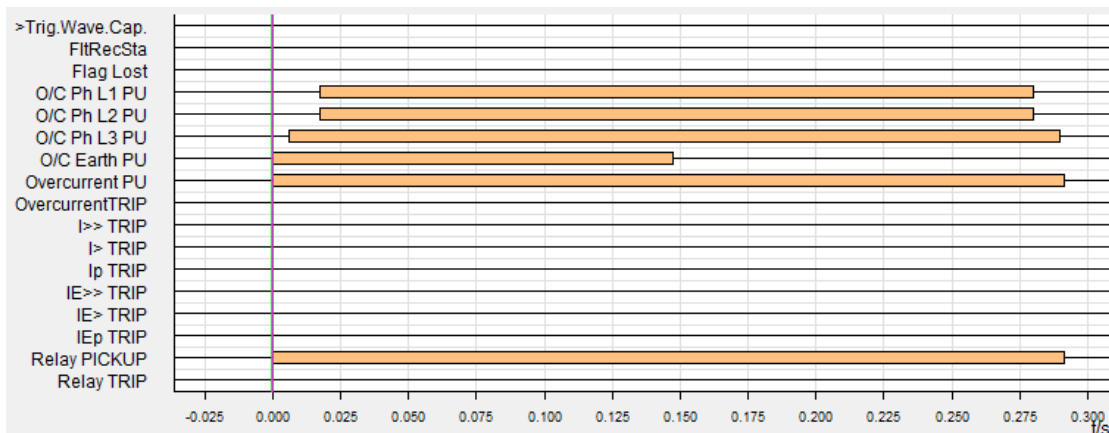
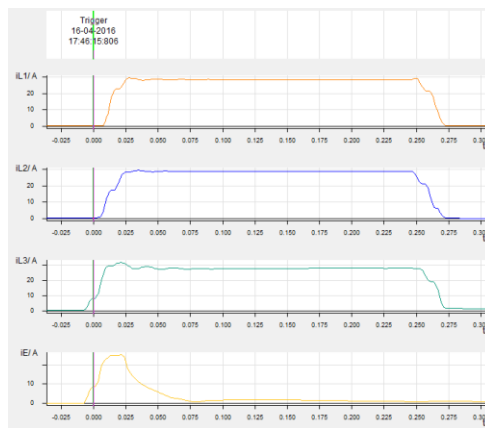

Falla Lunes 18-04-2016

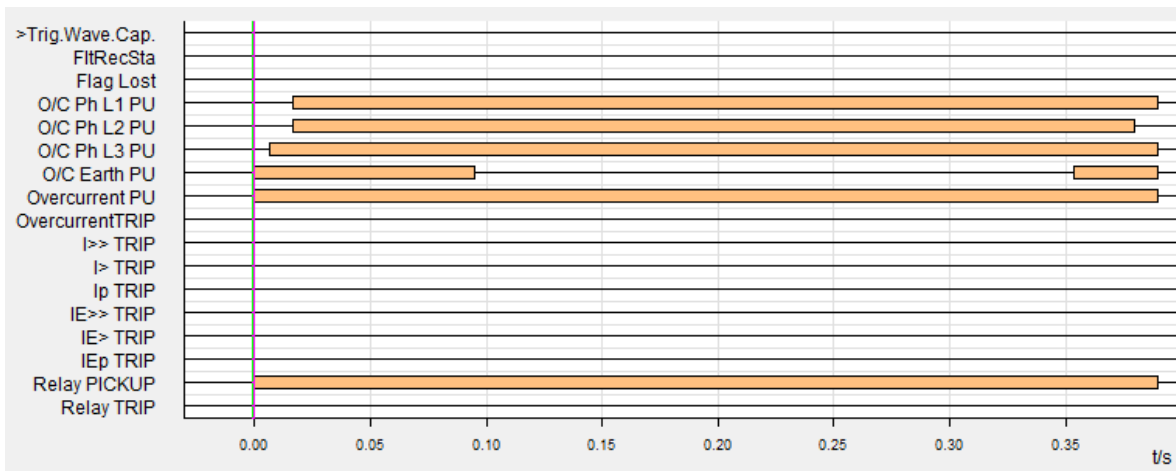
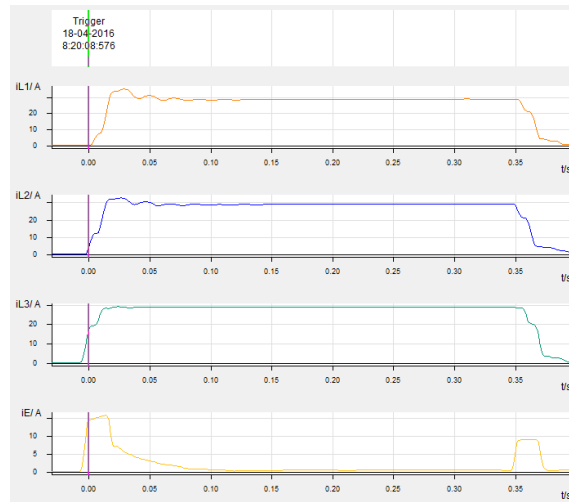

De lo anterior, se desprende que el disparo de la protección 7UT del transformador, el día Sábado 16-04-2016, se realiza debido a la operación de la función 51N ($3I_0$) al igual que la ocurrida el día Lunes 18-04-2016, de la cual se cuenta con registro y oscilografía (información adjunta al presente informe en archivos en formato “.dex”, extraídas de los relés).

La oscilación provocada por el cortocircuito, causó la desconexión de las unidades que se encontraban en servicio y la completa desenergización del Switchgear Florida 2. Las unidades generadoras que estaban en servicio, son las siguientes:

- Unidad 1 de Central Florida 2,
- Unidad 1 de Central Florida 3, y
- Central El Rincón.

Como consecuencia de lo anterior, se interrumpe el suministro hacia los alimentadores de distribución siguientes:

- Rojas Magallanes,
- Corporación,

- Aguas Andinas.

El operador del despacho de Chilectra solicita al operador de Florida, abrir los interruptores de los alimentadores de distribución de la barra de 12 kV de Florida 2.

El origen de la falla, se asocia a algún defecto aún no identificado, ubicado en el Switchgear de Central Florida 1, que habría producido un cortocircuito trifásico, alcanzando una magnitud cercana a los 7,7 kA, valor que se obtiene de la oscilografía registrada por el relé 7SJ del alimentador Florida 1.

La secuencia de operación de protecciones en Central Florida 2, es la siguiente:

1. En protección Siemens 7SJ62 del alimentador de Florida 1, la función 51 de fase (sobrecorriente temporizada), dispara a los 300 ms y desengancha al interruptor cuya extinción de corriente ocurre a los 400 ms.
2. En protección 7UT61 del transformador de Florida 110/12 kV, la función 51N (3xI₀) del lado de 110 kV genera un disparo cuyo tiempo específico se desconoce. Debido a que aún no se había extinguido la corriente en el interruptor Florida 1, el disparo del relé 7UT61 por 3I₀ activa el relé Maestro 86T que ordena el desenganche de los interruptores de 110 y 12 kV, sin embargo, la extinción de la corriente de falla la dio el interruptor Florida 1.

Antecedentes adicionales

3. La función 51 de la protección Siemens 7SJ62, de respaldo del transformador de Florida 110/12 kV, no disparó, dado que tiene tiempo de paso (+300 ms) ante fallas al interior de la Central Florida 2.
4. La función 51 de la protección Siemens 7SJ62, del alimentador de Florida 3, no disparó, dado que tiene tiempo de paso (+300 ms) para falla hacia el lado de la barra de 12 kV de Florida 2.
5. Unidad 1 de Central Florida 2, se desconecta del sistema por disparo de función de bajo voltaje (UV), residente en la protección G-30.
6. Unidad 1 de Central Florida 3, se desconecta del sistema por disparo de la función de pérdida de excitación, residente en protección G-30.
7. Unidad de Generación El Rincón, se desconecta del sistema por operación de protección de sobrecorriente, Siemens 7SJ62.

- | | | |
|-----------------------|---|--|
| a. Fenómeno físico | : | OTR2- Origen no determinado (Trip interruptor) |
| b. Elemento | : | PR2- Celdas |
| c. Fenómeno eléctrico | : | PR51N- Protección de sobrecorriente temporizada residual |
| d. Modo | : | 14- Varios |

- e. **Origen** : Interno
- f. **Código de falla** : 1008; Operación errónea de Interruptor / Relé / Protección.
- g. **Unidad o equipo afectado** : Central Completa.
- h. **Potencia instantánea previa a falla** :
 - i. Central Florida 2
 - 1. Unidad N°1: 6.5 MW.
 - 2. Unidad N°2: F/S Por bajo caudal.
 - ii. Central Florida 3
 - 1. Unidad N°1: 1.1 MW.
 - 2. Unidad N°2: 1.1 MW.
 - iii. Central El Rincón
 - 1. Unidad N°1: 0.21 MW.
- i. **Potencia instantánea posterior a falla** :
 - i. Central Florida 2
 - 1. Unidad N°1: F/S Por bajo caudal.
 - 2. Unidad N°2: 6.7 MW.
 - ii. Central Florida 3
 - 1. Unidad N°1: 0.0 MW.
 - 2. Unidad N°2: 0.0 MW.
 - iii. Central El Rincón
 - 1. Unidad N°1: 0.21 MW.

5. DIAGRAMA SIMPLIFICADO DE CONEXIÓN AL SISTEMA:

- Diagrama Central Florida General **Anexo 1**

6. PROTECCIONES OPERADAS:

a. Central Florida 2

- Registro de eventos Central Florida 2 **Anexo 2**
 - Protección Sobrecorriente de Alimentador Florida 1, Siemens 7SJ62,
 - Protección de Generador U1, GE G-30,

b. Central Florida 3

- Registro de eventos Central Florida 3 **Anexo 3**

- Protección de Generador U1, GE G-30,

C. Central El Rincón

- Registro de eventos Central Rincón **Anexo 4**
 - Protección de Generador, Siemens 7SJ62,

7. SETTING DE PROTECCIONES Y OSCILOGRAFIAS:

Setting de protecciones Central Florida 2

- Setting de Protección de Transformador, Siemens 7UT61, **Anexo 5**
- Setting de Protección de Transformador, Siemens 7SJ62, **Anexo 6**
- Setting de Protección de Alimentador Florida 1, Siemens 7SJ62, **Anexo 7**
- Setting de Protección de Unidad 1, GE G-30, **Anexo 8**

Setting de protecciones Central Florida 3

- Setting de Protección de Unidad 1, GE G-30, **Anexo 9**

Setting de protecciones Central Rincón

- Setting de Protección de Unidad, Siemens 7SJ62, **Anexo 10**

Oscilografías de protecciones Central Florida 2

- Oscilografía de Protección de Transformador, Siemens 7SJ62, **Anexo 11**
- Oscilografía de Protección de Alimentador Florida 1, Siemens 7SJ62, **Anexo 12**
- Oscilografía de Protección de Unidad 1, GE G-30, **Anexo 13**

Oscilografías de protecciones Central Florida 3

- Oscilografía de Protección de Unidad 1, GE G-30, **Anexo 14**

Oscilografías de protecciones Central Rincón

- Oscilografía de Protección de Unidad Rincón, Siemens 7SJ62, **Anexo 15**

8. SECUENCIA DE MANIOBRAS:

a. Central Florida 2

HORA	CENTRAL - S/E	MANIOBRA EJECUTADA
19:16	CF2	Desconectada Transformador de poder 110/12 Kv, apertura interruptor 110 y 12Kv como consecuencia salida de la barra 12Kv CF2 apertura de alimentador Rojas Magallanes, Corporación, CF3 completa, Rincón CF2 unidad N°1
19:17	CF2	Se comienzan maniobras de normalización de Grupo Electrógeno y servicio prescindibles
19:19	CF2	Se normaliza grupo electrógeno quedando central conectada al mismo
19:20	Chilectra	Se comunica despacho Chilectra Sr. Álvaro Leal, este indica abrir alimentadores
19:21	CF2	Se realiza apertura de los alimentadores Rojas Magallanes y Corporación,
19:22	CF2	Se realiza apertura de los interruptores de CF1-CF3-Agua andinas, para despeje total de la barra.
19:25	Cdec-Sic	Se toma contacto Con Sr. Nelson Catillo, por desconexión de transformador de 110/12, consulta principalmente horario de desconexión
19:34	Chilectra	Se comunica despacho Chilectra Sr. Álvaro Leal, este indica que alimentadores se encuentran con tensión de retorno.
19:45	Chilectra	Se indica cuáles son las protecciones operadas en Transformador 50G, sobrecorriente F3, Dif F1 Dif F3
19:52	Chilectra	Se indica que enviaron a la guardia para realización de revisión en SS/EE Florida
20:05	CF2	se revisa combustible de grupo electrógeno este se encuentra en 3/4
20:10	CF2	Llega Sr Jose Orellana, y comienza inspección a transformador junto a personal de guardia de chilectra.
20:22	Chilectra	Se toma contacto con despacho Sr. Juan Pablo Corbalán, el cual indica que guardia de chilectra no encuentra ningún anomalía en transformador por lado de 110, corroborando esta información con Sr. Jose Orellana
20:25	CF2	Se normaliza relé 86 de interruptor de transformador para realizar cierre
20:26	CF2	Se realiza una prueba de cierre lado 110, realizando apertura posteriormente
20:34	CF2	Cierre interruptor de 12Kv
20:35	CF2	Cierre interruptor de 110Kv
20:42	Cdec-Sic	Se informa a Sr. Juan Monarde, desconexión de unidades más apertura de transformador, conexión del mismo
21:45	A. Andinas	Cierre interruptor hacia A. Andinas
23:38	CF2	Conectada Unidad N°2 de Central Florida 2, por normalización de canal.
20:45	CF3	Cierre interruptor hacia CF3.
21:00	Rincón	Conectada Central El Rincón, de forma local.
21:20	CF3	Sr. Jose Orellana realiza pruebas de conexión de unidad N°2 CF3 conectando por 5 min y se desconecta, se realizan 2 intentos, se espera a personal de mantenimiento
21:21	Puntilla	Conectada Unidad N°3 de Central Puntilla, por normalización de canal.
21:24	A. Andinas	Se logra tomar contacto con personal de aguas andinas Mayerly Feliu, esta indica que desconexión de central no afecta de ninguna manera sus dependencias, se coordina cierre de alimentador A. andinas

HORA	CENTRAL - S/E	MANIOBRA EJECUTADA
21:45	A. Andinas	Cierre interruptor hacia A. Andinas
21:52	A. Andinas	Se toma contacto con sr. Luis Maldonado, el cual indica que se normalizara caudal hacia planta de A. Andinas
22:00	CF2	Se toma contacto Con Sr. Marcos Burgos, indicando que no se logra levantar Scada, este indica que no se podrá por existir problemas en servidor, se debe revisar, por momento ocupar el de otro Pc
22:05	A. Andinas	Se toma contacto con sr. Luis Maldonado, el cual indica que no se realizaran las pruebas debido a que aún agua en rio se encuentra turbia
22:15	CLF	Llega personal de apoyo para limpieza de rejias
23:11	Chilectra	Se toma contacto con personal de chilectra consultando cuando se normalizaran los alimentadores, estos indican que se normalizaran alrededor de las 2:00.
23:38	CF2	Conectada Unidad N°2 de Central Florida 2, por normalización de canal.
23:45	Cdec-Sic	Se informa a Sr. Gustavo Gomez, que se conectan Unidades N°1 y N°3 Central Puntilla, unidad N°2 CF2, también que de cierre a SD por curso Forzoso de Central Puntilla SD2907-SD2908

9. OTROS HECHOS RELEVANTES PARA LA OPERACIÓN

- a. **Fecha de Conexión** : sábado, 16 de abril de 2016
- b. **Hora de Conexión** : 20:35 Hrs.
- c. **Tiempo de desconexión** : 01:19 Hrs.
- d. **Pérdida de Generación** : 9 MWH. (De acuerdo a lo indicado a Despacho de Chilectra)

10. OBSERVACIONES GENERALES

Según lo informado por el Despacho de Chilectra, existió una pérdida de consumos asociados a la falla, quien informa que la pérdida total fue de 9 MWH, los cuales se desglosan de la siguiente manera:

- 4 MW, en alimentador Rojas Magallanes.
- 2 MW, en alimentador Corporación.
- 0 MW, en alimentador Canelo.

Se recomienda aumentar el retardo de operación e insensibilidad de la función de sobrecorriente residual de 110 kV, residente en la protección diferencial de transformador de Florida, dado que una falla pasante y desequilibrada, puede hacer operar la protección con el actual ajuste de protección.

11. ANEXOS

1. Diagrama Central Florida General
2. Registro de eventos Central Florida 2
3. Registro de eventos Central Florida 3
4. Registro de eventos Central Rincón
5. Setting de Protección de Transformador, Siemens 7UT61
6. Setting de Protección de Transformador, Siemens 7SJ62
7. Setting de Protección de Alimentador Florida 1, Siemens 7SJ62
8. Setting de Protección de Unidad 1, GE G-30
9. Setting de Protección de Unidad 1, GE G-30
10. Setting de Protección de Unidad, Siemens 7SJ62
11. Oscilografía de Protección de Transformador, Siemens 7SJ62
12. Oscilografía de Protección de Alimentador Florida 1, Siemens 7SJ62
13. Oscilografía de Protección de Unidad 1 Florida 2, GE G-30
14. Oscilografía de Protección de Unidad 1 Florida 3, GE G-30
15. Oscilografía de Protección de Unidad Rincón, Siemens 7SJ62

Realizado por : Carlos F. Cartes V. Operador Centro De Control
Revisado por : Jose Orellana Jefe de Operación de Centrales

NOTA: El presente informe está asociado a los siguientes IF cargados en red Neo Mante: IF1154-IF1155-IF1156-IF1157

Anexo 1.0
Diagrama Central Florida General

Anexo 2.0
Registro de eventos Central Florida 2

Anexo 2.1
Protección Sobrecorriente de Alimentador Florida 1 - Siemens 7SJ62

Anexo 2.2
Protección de Generador U1 - GE G-30

Anexo 3.0
Registro de eventos Central Florida 3
Protección de Generador U1 - GE G-30

Anexo 4.0
Registro de eventos Central Rincón

Anexo 5.0
Setting de Protección de Transformador, Siemens 7UT61

Anexo 6.0
Setting de Protección de Transformador, Siemens 7SJ62

Anexo 7.0
Setting de Protección de Alimentador Florida 1, Siemens 7SJ62

Anexo 8.0
Setting de Protección de Unidad 1 Florida 2, GE G-30

Anexo 9.0
Setting de Protección de Unidad 1 Florida 3, GE G-30

Anexo 10.0
Setting de Protección de Unidad Rincón, Siemens 7SJ62

Anexo 11.0
Oscilografía de Protección de Transformador, Siemens 7SJ62

Anexo 12.0
Oscilografía de Protección de Alimentador Florida 1, Siemens 7SJ62

Anexo 13.0
Oscilografía de Protección de Unidad 1 Florida 2, GE G-30

Anexo 14.0
Oscilografía de Protección de Unidad 1 Florida 3, GE G-30

Anexo 15.0
Oscilografía de Protección de Unidad Rincón, Siemens 7SJ62

FLORIDA N°3
VER PLANO EP-CF-MUL-004

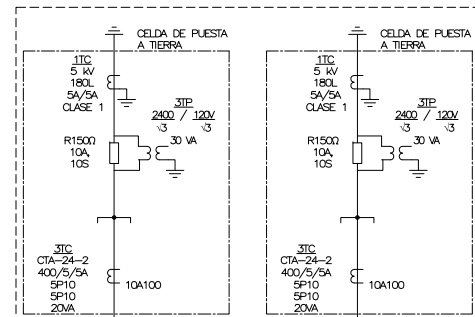

RINCON
VER PLANO
EP-CF-MUL-005

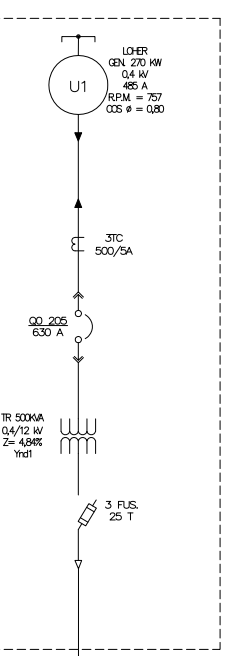

FLORIDA N°2
VER PLANO EP-CF-MUL-003

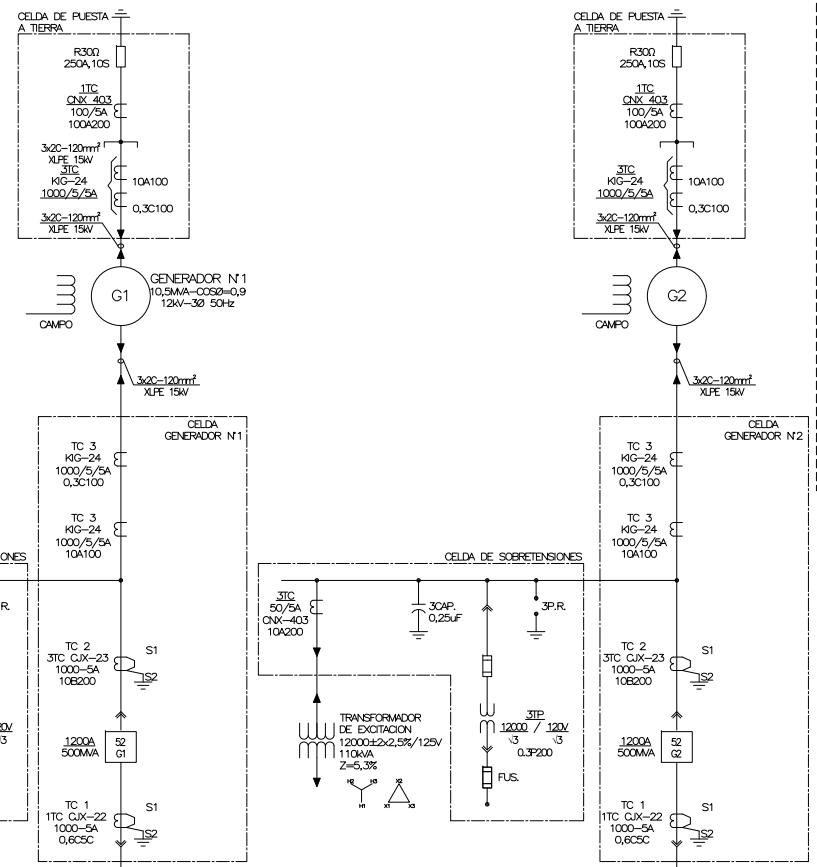

CHILECTRA

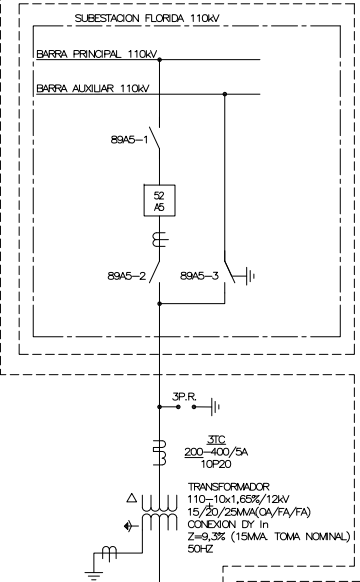

FLORIDA N°1
VER PLANO EP-CF-MUL-002

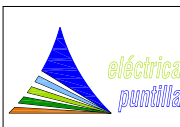
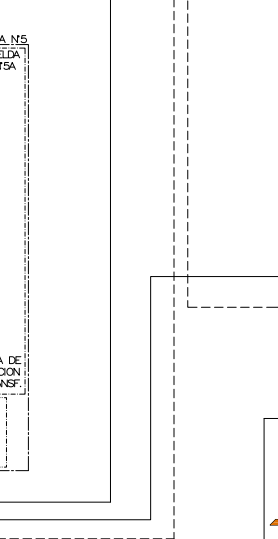
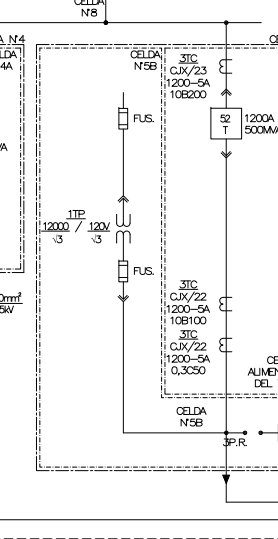
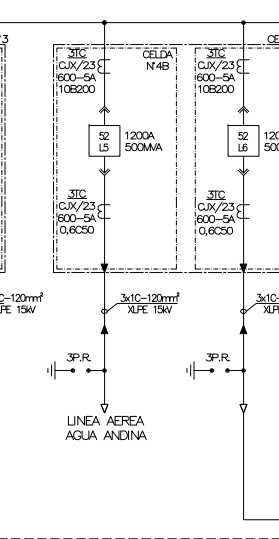
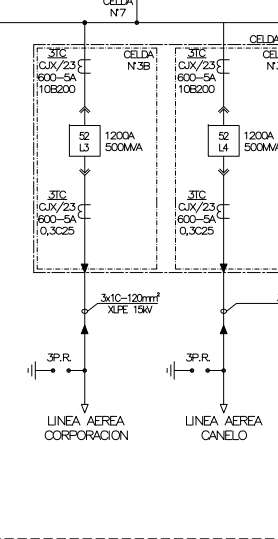
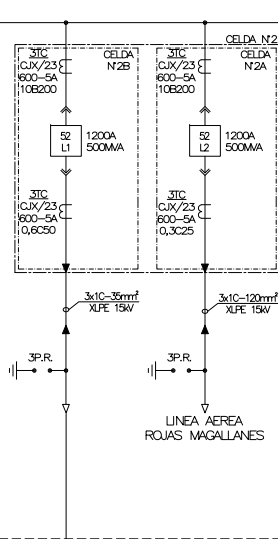
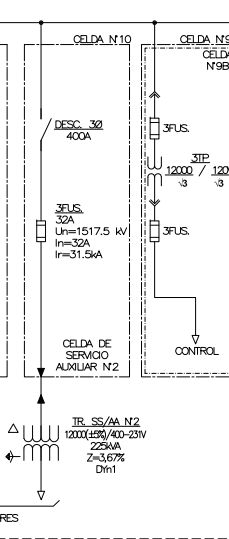
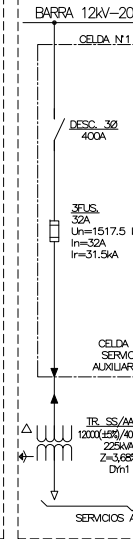
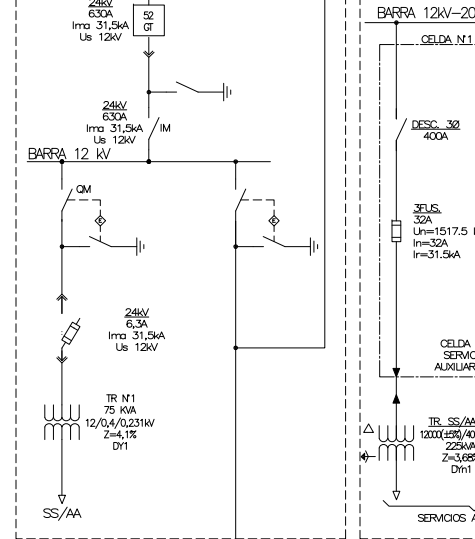
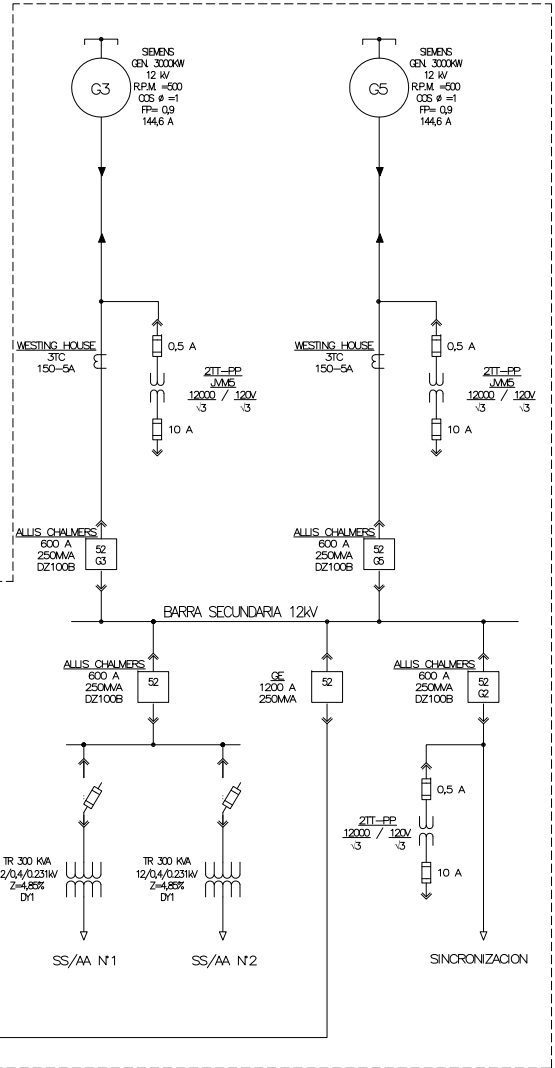

Area: CENTRAL FLORIDA
Titulo: DIAGRAMA UNILINEAL GENERAL

Departamento:	Nombre	Firma	Fecha
Mantenimiento	P. VILCHES		29-04-15
Lamina: 1 de 1	REVISO	O. LIRA	29-04-15
	APROBO	P. TOLOSA	29-04-15
PL. N° EP-CF-MUL-01	Rev. D	Escala 1 : 1	Formato A1



REVISIONES	DESCRIPCION	DIS.	REV.	JP	FECHA
D	ACTUALIZACION ABRIL 2015	P.V.V.	O.L.S.	P.T.Z.	29-04-15
C	ACTUALIZACION ABRIL 2015	P.V.V.	O.L.S.	P.T.Z.	24-04-15
B	EMITIDO PARA APROBACION DEL CLIENTE	P.V.V.	O.L.S.	P.T.Z.	22-04-15
A	EMITIDO PARA COORDINACION INTERNA	P.V.V.	O.L.S.	P.T.Z.	17-04-15

Puntilla / Folder / FLORIDA 1 Var

MLFB: 7SJ6215**E901FC0
Parameter set version: V04.90.05
Device path: C:\Siemens\DIGSI4\D4PROJ\Puntilla\P7DI\GV\ST\00000007
Author:
Creation date: 21.04.16 11:40:20
Last modified: 21.04.16 16:56:14
Operating mode: Offline
Comment:
Setting values in: Secondary value description

PRINT - CONTENTS

1	Indications	2
1.1	Avisos de perturbación - 000122 / 16-04-2016 19:20:31.915 - Puntilla / Folder / FLORIDA 1 Var/7SJ621	2.....

1 Indications

1.1 Avisos de perturbación - 000122 / 16-04-2016 19:20:31.915 - Puntilla / Folder / FLORIDA 1 Var/7SJ621

Avisos de perturbación - 000122 / 16-04-2016 19:20:31.915 - Puntilla / Folder / FLORIDA 1 Var/7SJ621

Number	Indication	Value	Date and time	Cause	State
00301	Falta en Red, numerado	122 - Entra	16.04.2016 19:20:31.915		
00302	Perturbación,evento de faltas	122 - Entra	16.04.2016 19:20:31.915		
00501	Arranque general del relé de protección	Entra	0 ms		
01761	Prot. sobreintens. arranque general	Entra	0 ms		
01765	Arranque prot.sobreintens. tierra (E)	Entra	0 ms		
01764	Arranque prot.sobreintens. fase L3	Entra	0 ms		
01820	Arranque por sobreintensidad escalón Ip	Entra	0 ms		
01834	Arranque sobreintens. escalón IE> tierra	Entra	0 ms		
01762	Arranque prot.sobreintens. fase L1	Entra	16 ms		
01763	Arranque prot.sobreintens. fase L2	Entra	17 ms		
00511	Disparo del relé (general)	Entra	300 ms		
01791	Prot. sobreintens. disparo general	Entra	301 ms		
01825	Disparo prot. sobreintensidad Ip (fases)	Entra	301 ms		
01765	Arranque prot.sobreintens. tierra (E)	Sale	329 ms		
01834	Arranque sobreintens. escalón IE> tierra	Sale	329 ms		
00533	Intensidad de falta fase L1 primaria	1,38 kA	337 ms		
00534	Intensidad de falta fase L2 primaria	1,36 kA	337 ms		
00535	Intensidad de falta fase L3 primaria	1,35 kA	337 ms		
01765	Arranque prot.sobreintens. tierra (E)	Entra	359 ms		
01834	Arranque sobreintens. escalón IE> tierra	Entra	359 ms		
01762	Arranque prot.sobreintens. fase L1	Sale	389 ms		
01764	Arranque prot.sobreintens. fase L3	Sale	389 ms		
01765	Arranque prot.sobreintens. tierra (E)	Sale	399 ms		
01763	Arranque prot.sobreintens. fase L2	Sale	399 ms		
01820	Arranque por sobreintensidad escalón Ip	Sale	399 ms		
01761	Prot. sobreintens. arranque general	Sale	399 ms		
01834	Arranque sobreintens. escalón IE> tierra	Sale	399 ms		
00545	T.transcurrido de arranque a reposición	400 ms	400 ms		
00546	T.transcurrido de arranque a disparo	300 ms	400 ms		
00301	Falta en Red, numerado	122 - Sale	16.04.2016 19:20:32.315		

Device	Event	Date/Time	Cause	D
Quick Connect Device	25737	Apr 19 2016 05:55:33.139789	GEN UNBAL ST G2 DPO	
Quick Connect Device	25736	Apr 19 2016 05:55:33.119813	GEN UNBAL ST G2 PKP	
Quick Connect Device	25735	Apr 19 2016 05:55:27.105570	GEN UNBAL ST G2 DPO	
Quick Connect Device	25734	Apr 19 2016 05:55:27.065614	GEN UNBAL ST G2 PKP	
Quick Connect Device	25733	Apr 18 2016 15:35:55.455883	Bloqueo32R Off	
Quick Connect Device	25732	Apr 18 2016 15:34:25.452522	Bloqueo32R On	
Quick Connect Device	25731	Apr 18 2016 15:34:25.452522	Int_Cerrado On	
Quick Connect Device	25730	Apr 18 2016 15:34:25.448746	IntCerrado On	
Quick Connect Device	25729	Apr 18 2016 15:34:17.463918	81U_pu Off	
Quick Connect Device	25728	Apr 18 2016 15:34:17.463918	UNDERFREQ 1 DPO	
Quick Connect Device	25727	Apr 18 2016 15:34:14.295674	UNDERFREQ 2 DPO	
Quick Connect Device	25726	Apr 18 2016 15:34:13.077513	27P_pu Off	
Quick Connect Device	25725	Apr 18 2016 15:34:13.077513	PHASE UV1 DPO B	
Quick Connect Device	25724	Apr 18 2016 15:34:13.077513	PHASE UV1 DPO A	
Quick Connect Device	25723	Apr 18 2016 15:34:13.072265	PHASE UV1 DPO C	
Quick Connect Device	25722	Apr 18 2016 15:34:12.751687	PHASE UV2 DPO B	
Quick Connect Device	25721	Apr 18 2016 15:34:12.751687	PHASE UV2 DPO A	
Quick Connect Device	25720	Apr 18 2016 15:34:12.746425	UNDERFREQ 3 DPO	
Quick Connect Device	25719	Apr 18 2016 15:34:12.746425	PHASE UV2 DPO C	
Quick Connect Device	25718	Apr 18 2016 15:34:12.435618	PHASE UV2 PKP B	
Quick Connect Device	25717	Apr 18 2016 15:34:12.435618	PHASE UV2 PKP A	
Quick Connect Device	25716	Apr 18 2016 15:34:12.435618	PHASE UV1 PKP B	
Quick Connect Device	25715	Apr 18 2016 15:34:12.435618	PHASE UV1 PKP A	
Quick Connect Device	25714	Apr 18 2016 15:34:12.430342	27P_pu On	
Quick Connect Device	25713	Apr 18 2016 15:34:12.430342	PHASE UV2 PKP C	
Quick Connect Device	25712	Apr 18 2016 15:34:12.430342	PHASE UV1 PKP C	
Quick Connect Device	25711	Apr 18 2016 15:34:09.805506	81U_pu On	
Quick Connect Device	25710	Apr 18 2016 15:34:09.805506	UNDERFREQ 3 PKP	
Quick Connect Device	25709	Apr 18 2016 15:34:09.805506	UNDERFREQ 2 PKP	
Quick Connect Device	25708	Apr 18 2016 15:34:09.805506	UNDERFREQ 1 PKP	
Quick Connect Device	25707	Apr 18 2016 15:34:09.800366	81U_pu Off	
Quick Connect Device	25706	Apr 18 2016 15:34:09.800366	UNDERFREQ 3 DPO	
Quick Connect Device	25705	Apr 18 2016 15:34:09.800366	UNDERFREQ 2 DPO	
Quick Connect Device	25704	Apr 18 2016 15:34:09.800366	UNDERFREQ 1 DPO	
Quick Connect Device	25703	Apr 18 2016 15:34:09.795266	81U_pu On	
Quick Connect Device	25702	Apr 18 2016 15:34:09.795266	UNDERFREQ 3 PKP	
Quick Connect Device	25701	Apr 18 2016 15:34:09.795266	UNDERFREQ 2 PKP	
Quick Connect Device	25700	Apr 18 2016 15:34:09.795266	UNDERFREQ 1 PKP	
Quick Connect Device	25699	Apr 18 2016 15:34:09.790168	81U_pu Off	
Quick Connect Device	25698	Apr 18 2016 15:34:09.790168	UNDERFREQ 3 DPO	
Quick Connect Device	25697	Apr 18 2016 15:34:09.790168	UNDERFREQ 2 DPO	
Quick Connect Device	25696	Apr 18 2016 15:34:09.790168	UNDERFREQ 1 DPO	
Quick Connect Device	25695	Apr 18 2016 15:34:09.785068	81U_pu On	
Quick Connect Device	25694	Apr 18 2016 15:34:09.785068	UNDERFREQ 3 PKP	
Quick Connect Device	25693	Apr 18 2016 15:34:09.785068	UNDERFREQ 2 PKP	
Quick Connect Device	25692	Apr 18 2016 15:34:09.785068	UNDERFREQ 1 PKP	
Quick Connect Device	25691	Apr 18 2016 13:48:10.234909	RESET OP(PUSHBUTT	
Quick Connect Device	25690	Apr 18 2016 13:39:34.841551	SNTP FAILURE	
Quick Connect Device	25689	Apr 18 2016 12:24:17.092737	RESET OP(PUSHBUTT	
Quick Connect Device	25688	Apr 18 2016 11:54:04.981097	SNTP FAILURE	
Quick Connect Device	25687	Apr 18 2016 10:37:04.028813	RESET OP(PUSHBUTT	
Quick Connect Device	25686	Apr 18 2016 10:36:59.046317	RESET OP(PUSHBUTT	
Quick Connect Device	25685	Apr 18 2016 09:54:25.130558	SNTP FAILURE	

Device	Event	Date/Time	Cause	D
Quick Connect Device	25684	Apr 18 2016 09:52:52.652325	Trp86 Off	
Quick Connect Device	25683	Apr 18 2016 09:52:52.652325	Trip Off	
Quick Connect Device	25682	Apr 18 2016 09:52:52.649823	81O_op Off	
Quick Connect Device	25681	Apr 18 2016 09:52:52.649823	OVERFREQ 3 DPO	
Quick Connect Device	25680	Apr 18 2016 09:52:52.142674	81O_pu Off	
Quick Connect Device	25679	Apr 18 2016 09:52:50.977790	SRC1 VT FF VOLLOSS	
Quick Connect Device	25678	Apr 18 2016 09:52:42.212865	Trp86 On	
Quick Connect Device	25677	Apr 18 2016 09:52:42.212865	Trip On	
Quick Connect Device	25676	Apr 18 2016 09:52:42.212865	OSCILLOGRAPHY	
Quick Connect Device	25675	Apr 18 2016 09:52:42.212865	TRIPBUS 1 OP	
Quick Connect Device	25674	Apr 18 2016 09:52:42.212865	TRIPBUS 1 PKP	
Quick Connect Device	25673	Apr 18 2016 09:52:42.211054	81O_op On	
Quick Connect Device	25672	Apr 18 2016 09:52:42.211054	OVERFREQ 3 OP	
Quick Connect Device	25671	Apr 18 2016 09:52:39.403759	Trp86 Off	
Quick Connect Device	25670	Apr 18 2016 09:52:39.403759	Trip Off	
Quick Connect Device	25669	Apr 18 2016 09:52:39.403759	27P_pu Off	
Quick Connect Device	25668	Apr 18 2016 09:52:39.403759	27P_op Off	
Quick Connect Device	25667	Apr 18 2016 09:52:39.403759	PHASE UV2 DPO C	
Quick Connect Device	25666	Apr 18 2016 09:52:39.403759	PHASE UV2 DPO A	
Quick Connect Device	25665	Apr 18 2016 09:52:39.403759	PHASE UV1 DPO C	
Quick Connect Device	25664	Apr 18 2016 09:52:39.403759	PHASE UV1 DPO A	
Quick Connect Device	25663	Apr 18 2016 09:52:39.385878	PHASE UV2 DPO B	
Quick Connect Device	25662	Apr 18 2016 09:52:39.385878	PHASE UV1 DPO B	
Quick Connect Device	25661	Apr 18 2016 09:52:39.360836	PHASE UV1 OP B	
Quick Connect Device	25660	Apr 18 2016 09:52:39.360836	PHASE UV1 OP A	
Quick Connect Device	25659	Apr 18 2016 09:52:38.896311	PHASE UV2 OP A	
Quick Connect Device	25658	Apr 18 2016 09:52:38.593054	PHASE UV2 OP C	
Quick Connect Device	25657	Apr 18 2016 09:52:38.551062	Trp86 On	
Quick Connect Device	25656	Apr 18 2016 09:52:38.551062	Trip On	
Quick Connect Device	25655	Apr 18 2016 09:52:38.551062	OSCILLOGRAPHY	
Quick Connect Device	25654	Apr 18 2016 09:52:38.551062	27P_op On	
Quick Connect Device	25653	Apr 18 2016 09:52:38.551062	TRIPBUS 1 OP	
Quick Connect Device	25652	Apr 18 2016 09:52:38.551062	TRIPBUS 1 PKP	
Quick Connect Device	25651	Apr 18 2016 09:52:38.551062	PHASE UV2 OP B	
Quick Connect Device	25650	Apr 18 2016 09:52:37.893496	PHASE UV2 PKP A	
Quick Connect Device	25649	Apr 18 2016 09:52:37.837878	PHASE UV2 DPO A	
Quick Connect Device	25648	Apr 18 2016 09:52:37.591917	PHASE UV2 PKP C	
Quick Connect Device	25647	Apr 18 2016 09:52:37.551226	PHASE UV2 PKP B	
Quick Connect Device	25646	Apr 18 2016 09:52:37.510152	PHASE UV2 PKP A	
Quick Connect Device	25645	Apr 18 2016 09:52:37.389063	PHASE UV2 DPO C	
Quick Connect Device	25644	Apr 18 2016 09:52:37.355748	PHASE UV2 DPO B	
Quick Connect Device	25643	Apr 18 2016 09:52:37.350956	PHASE UV2 DPO A	
Quick Connect Device	25642	Apr 18 2016 09:52:37.206131	OVERFREQ 3 PKP	
Quick Connect Device	25641	Apr 18 2016 09:52:37.176571	OVERFREQ 2 PKP	
Quick Connect Device	25640	Apr 18 2016 09:52:37.076652	81O_pu On	
Quick Connect Device	25639	Apr 18 2016 09:52:37.076652	OVERFREQ 1 PKP	
Quick Connect Device	25638	Apr 18 2016 09:52:36.963858	PHASE UV2 PKP B	
Quick Connect Device	25637	Apr 18 2016 09:52:36.906119	PHASE UV2 DPO B	
Quick Connect Device	25636	Apr 18 2016 09:52:36.895487	81U_pu Off	
Quick Connect Device	25635	Apr 18 2016 09:52:36.895487	UNDERFREQ 1 DPO	
Quick Connect Device	25634	Apr 18 2016 09:52:36.815619	UNDERFREQ 2 DPO	
Quick Connect Device	25633	Apr 18 2016 09:52:36.750894	UNDERFREQ 3 DPO	
Quick Connect Device	25632	Apr 18 2016 09:52:36.511545	PHASE UV2 PKP B	

Device	Event	Date/Time	Cause	D
Quick Connect Device	25631	Apr 18 2016 09:52:36.505922	PHASE UV2 PKP A	
Quick Connect Device	25630	Apr 18 2016 09:52:36.500303	PHASE UV2 PKP C	
Quick Connect Device	25629	Apr 18 2016 09:52:36.494682	NEUTRAL OV1 DPO	
Quick Connect Device	25628	Apr 18 2016 09:52:36.483440	Trp86 Off	
Quick Connect Device	25627	Apr 18 2016 09:52:36.483440	Trip Off	
Quick Connect Device	25626	Apr 18 2016 09:52:36.483440	27P_op Off	
Quick Connect Device	25625	Apr 18 2016 09:52:36.483440	NEUTRAL OV1 PKP	
Quick Connect Device	25624	Apr 18 2016 09:52:36.483440	PHASE UV2 DPO C	
Quick Connect Device	25623	Apr 18 2016 09:52:36.483440	PHASE UV2 DPO B	
Quick Connect Device	25622	Apr 18 2016 09:52:36.477819	PHASE UV2 DPO A	
Quick Connect Device	25621	Apr 18 2016 09:52:36.469387	Int_Cerrado Off	
Quick Connect Device	25620	Apr 18 2016 09:52:36.466975	IntCerrado Off	
Quick Connect Device	25619	Apr 18 2016 09:52:36.449693	PHASE UV2 OP B	
Quick Connect Device	25618	Apr 18 2016 09:52:36.415864	Trp86 On	
Quick Connect Device	25617	Apr 18 2016 09:52:36.415864	Trip On	
Quick Connect Device	25616	Apr 18 2016 09:52:36.415864	OSCILLOGRAPHY	
Quick Connect Device	25615	Apr 18 2016 09:52:36.415864	27P_op On	
Quick Connect Device	25614	Apr 18 2016 09:52:36.415864	TRIPBUS 1 OP	
Quick Connect Device	25613	Apr 18 2016 09:52:36.415864	TRIPBUS 1 PKP	
Quick Connect Device	25612	Apr 18 2016 09:52:36.415864	PHASE UV2 OP A	
Quick Connect Device	25611	Apr 18 2016 09:52:35.491805	PHASE UV2 PKP C	
Quick Connect Device	25610	Apr 18 2016 09:52:35.444450	PHASE UV2 PKP B	
Quick Connect Device	25609	Apr 18 2016 09:52:35.414847	PHASE UV2 PKP A	
Quick Connect Device	25608	Apr 18 2016 09:52:34.588385	PHASE UV1 PKP C	
Quick Connect Device	25607	Apr 18 2016 09:52:34.361691	27P_pu On	
Quick Connect Device	25606	Apr 18 2016 09:52:34.361691	PHASE UV1 PKP B	
Quick Connect Device	25605	Apr 18 2016 09:52:34.361691	PHASE UV1 PKP A	
Quick Connect Device	25604	Apr 18 2016 09:52:33.706772	27P_pu Off	
Quick Connect Device	25603	Apr 18 2016 09:52:33.706772	PHASE UV1 DPO A	
Quick Connect Device	25602	Apr 18 2016 09:52:33.633562	UNDERFREQ 3 PKP	
Quick Connect Device	25601	Apr 18 2016 09:52:33.597135	PHASE UV1 DPO B	
Quick Connect Device	25600	Apr 18 2016 09:52:33.529762	UNDERFREQ 2 PKP	
Quick Connect Device	25599	Apr 18 2016 09:52:33.509101	PHASE UV1 DPO C	
Quick Connect Device	25598	Apr 18 2016 09:52:33.238155	81U_pu On	
Quick Connect Device	25597	Apr 18 2016 09:52:33.238155	UNDERFREQ 1 PKP	
Quick Connect Device	25596	Apr 18 2016 09:52:32.716909	PHASE UV2 DPO A	
Quick Connect Device	25595	Apr 18 2016 09:52:32.701926	PHASE UV2 DPO B	
Quick Connect Device	25594	Apr 18 2016 09:52:32.681949	PHASE UV2 DPO C	
Quick Connect Device	25593	Apr 18 2016 09:52:32.651978	PHASE UV2 PKP A	
Quick Connect Device	25592	Apr 18 2016 09:52:32.651978	PHASE UV1 PKP A	
Quick Connect Device	25591	Apr 18 2016 09:52:32.636995	PHASE UV2 DPO A	
Quick Connect Device	25590	Apr 18 2016 09:52:32.636995	PHASE UV1 DPO A	
Quick Connect Device	25589	Apr 18 2016 09:52:32.612023	50_51P_pu Off	
Quick Connect Device	25588	Apr 18 2016 09:52:32.612023	PHASE TOC1 DPO C	
Quick Connect Device	25587	Apr 18 2016 09:52:32.612023	PHASE TOC1 DPO B	
Quick Connect Device	25586	Apr 18 2016 09:52:32.612023	PHASE TOC1 DPO A	
Quick Connect Device	25585	Apr 18 2016 09:52:32.607029	27P_pu On	
Quick Connect Device	25584	Apr 18 2016 09:52:32.607029	PHASE UV2 PKP C	
Quick Connect Device	25583	Apr 18 2016 09:52:32.607029	PHASE UV2 PKP B	
Quick Connect Device	25582	Apr 18 2016 09:52:32.607029	PHASE UV2 PKP A	
Quick Connect Device	25581	Apr 18 2016 09:52:32.607029	PHASE UV1 PKP C	
Quick Connect Device	25580	Apr 18 2016 09:52:32.607029	PHASE UV1 PKP B	
Quick Connect Device	25579	Apr 18 2016 09:52:32.607029	PHASE UV1 PKP A	

Device	Event	Date/Time	Cause	D
Quick Connect Device	25578	Apr 18 2016 09:52:32.572068	50_51P_pu On	
Quick Connect Device	25577	Apr 18 2016 09:52:32.572068	PHASE TOC1 PKP C	
Quick Connect Device	25576	Apr 18 2016 09:52:32.572068	PHASE TOC1 PKP B	
Quick Connect Device	25575	Apr 18 2016 09:52:32.572068	PHASE TOC1 PKP A	
Quick Connect Device	25574	Apr 18 2016 09:52:32.552089	27P_pu Off	
Quick Connect Device	25573	Apr 18 2016 09:52:32.552089	PHASE UV2 DPO C	
Quick Connect Device	25572	Apr 18 2016 09:52:32.552089	PHASE UV2 DPO B	
Quick Connect Device	25571	Apr 18 2016 09:52:32.552089	PHASE UV2 DPO A	
Quick Connect Device	25570	Apr 18 2016 09:52:32.552089	PHASE UV1 DPO C	
Quick Connect Device	25569	Apr 18 2016 09:52:32.552089	PHASE UV1 DPO B	
Quick Connect Device	25568	Apr 18 2016 09:52:32.552089	PHASE UV1 DPO A	
Quick Connect Device	25567	Apr 18 2016 09:52:32.512133	50_51P_pu Off	
Quick Connect Device	25566	Apr 18 2016 09:52:32.512133	PHASE TOC1 DPO C	
Quick Connect Device	25565	Apr 18 2016 09:52:32.512133	PHASE TOC1 DPO B	
Quick Connect Device	25564	Apr 18 2016 09:52:32.512133	PHASE TOC1 DPO A	
Quick Connect Device	25563	Apr 18 2016 09:52:32.512133	PHASE UV2 PKP A	
Quick Connect Device	25562	Apr 18 2016 09:52:32.512133	PHASE UV1 PKP A	
Quick Connect Device	25561	Apr 18 2016 09:52:32.507139	27P_pu On	
Quick Connect Device	25560	Apr 18 2016 09:52:32.507139	PHASE UV2 PKP C	
Quick Connect Device	25559	Apr 18 2016 09:52:32.507139	PHASE UV2 PKP B	
Quick Connect Device	25558	Apr 18 2016 09:52:32.507139	PHASE UV1 PKP C	
Quick Connect Device	25557	Apr 18 2016 09:52:32.507139	PHASE UV1 PKP B	
Quick Connect Device	25556	Apr 18 2016 09:52:32.472175	PHASE TOC1 PKP C	
Quick Connect Device	25555	Apr 18 2016 09:52:32.472175	PHASE TOC1 PKP B	
Quick Connect Device	25554	Apr 18 2016 09:52:32.462188	50_51P_pu On	
Quick Connect Device	25553	Apr 18 2016 09:52:32.462188	PHASE TOC1 PKP A	
Quick Connect Device	25552	Apr 18 2016 09:52:32.442210	27P_pu Off	
Quick Connect Device	25551	Apr 18 2016 09:52:32.442210	PHASE UV2 DPO B	
Quick Connect Device	25550	Apr 18 2016 09:52:32.442210	PHASE UV1 DPO B	
Quick Connect Device	25549	Apr 18 2016 09:52:32.437215	PHASE UV2 DPO C	
Quick Connect Device	25548	Apr 18 2016 09:52:32.437215	PHASE UV1 DPO C	
Quick Connect Device	25547	Apr 18 2016 09:52:32.432221	PHASE UV2 DPO A	
Quick Connect Device	25546	Apr 18 2016 09:52:32.432221	PHASE UV1 DPO A	
Quick Connect Device	25545	Apr 18 2016 09:52:32.412243	GEN UNBAL ST G2 DPO	
Quick Connect Device	25544	Apr 18 2016 09:52:32.402254	50_51P_pu Off	
Quick Connect Device	25543	Apr 18 2016 09:52:32.402254	PHASE TOC1 DPO C	
Quick Connect Device	25542	Apr 18 2016 09:52:32.397258	PHASE UV2 PKP B	
Quick Connect Device	25541	Apr 18 2016 09:52:32.397258	PHASE UV2 PKP A	
Quick Connect Device	25540	Apr 18 2016 09:52:32.392265	PHASE TOC1 DPO B	
Quick Connect Device	25539	Apr 18 2016 09:52:32.392265	PHASE UV2 PKP C	
Quick Connect Device	25538	Apr 18 2016 09:52:32.392265	PHASE UV1 PKP B	
Quick Connect Device	25537	Apr 18 2016 09:52:32.392265	PHASE UV1 PKP A	
Quick Connect Device	25536	Apr 18 2016 09:52:32.387270	27P_pu On	
Quick Connect Device	25535	Apr 18 2016 09:52:32.387270	PHASE UV1 PKP C	
Quick Connect Device	25534	Apr 18 2016 09:52:32.382276	PHASE TOC1 DPO A	
Quick Connect Device	25533	Apr 18 2016 09:52:32.372275	NEUTRAL OV1 DPO	
Quick Connect Device	25532	Apr 18 2016 09:52:32.362278	NEUTRAL OV1 PKP	
Quick Connect Device	25531	Apr 18 2016 09:52:32.352279	GEN UNBAL ST G2 PKP	
Quick Connect Device	25530	Apr 18 2016 09:52:32.239790	PHASE IOC1 DPO B	
Quick Connect Device	25529	Apr 18 2016 09:52:32.234790	PHASE IOC1 DPO C	
Quick Connect Device	25528	Apr 18 2016 09:52:32.229789	PHASE IOC1 DPO A	
Quick Connect Device	25527	Apr 18 2016 09:52:32.072333	GEN UNBAL ST G1 DPO	
Quick Connect Device	25526	Apr 18 2016 09:52:32.052341	GEN UNBAL ST G2 DPO	

Device	Event	Date/Time	Cause	D
Quick Connect Device	25525	Apr 18 2016 09:52:32.022367	NEUTRAL OV1 DPO	
Quick Connect Device	25524	Apr 18 2016 09:52:32.022367	SRC1 VT FF VOLLOSS	
Quick Connect Device	25523	Apr 18 2016 09:52:32.017374	PHASE IOC1 PKP A	
Quick Connect Device	25522	Apr 18 2016 09:52:32.012381	50_51P_pu On	
Quick Connect Device	25521	Apr 18 2016 09:52:32.012381	GEN UNBAL STG1 PKP	
Quick Connect Device	25520	Apr 18 2016 09:52:32.012381	PHASE TOC1 PKP C	
Quick Connect Device	25519	Apr 18 2016 09:52:32.012381	PHASE TOC1 PKP B	
Quick Connect Device	25518	Apr 18 2016 09:52:32.012381	PHASE TOC1 PKP A	
Quick Connect Device	25517	Apr 18 2016 09:52:32.012381	PHASE IOC1 PKP C	
Quick Connect Device	25516	Apr 18 2016 09:52:32.012381	PHASE IOC1 PKP B	
Quick Connect Device	25515	Apr 18 2016 09:52:32.002394	NEUTRAL OV1 PKP	
Quick Connect Device	25514	Apr 18 2016 09:52:31.992392	GEN UNBAL STG2 PKP	
Quick Connect Device	25513	Apr 17 2016 17:57:59.951659	Bloqueo32R Off	
Quick Connect Device	25512	Apr 17 2016 17:56:29.947837	Bloqueo32R On	
Quick Connect Device	25511	Apr 17 2016 17:56:29.947837	Int_Cerrado On	
Quick Connect Device	25510	Apr 17 2016 17:56:29.944694	IntCerrado On	
Quick Connect Device	25509	Apr 17 2016 17:56:14.646668	81U_pu Off	
Quick Connect Device	25508	Apr 17 2016 17:56:14.646668	UNDERFREQ 1 DPO	
Quick Connect Device	25507	Apr 17 2016 17:56:10.773855	UNDERFREQ 2 DPO	
Quick Connect Device	25506	Apr 17 2016 17:56:08.931295	UNDERFREQ 3 DPO	
Quick Connect Device	25505	Apr 17 2016 17:56:08.039904	27P_pu Off	
Quick Connect Device	25504	Apr 17 2016 17:56:08.039904	PHASE UV1 DPO B	
Quick Connect Device	25503	Apr 17 2016 17:56:08.039904	PHASE UV1 DPO A	
Quick Connect Device	25502	Apr 17 2016 17:56:08.034616	PHASE UV1 DPO C	
Quick Connect Device	25501	Apr 17 2016 17:56:07.711750	PHASE UV2 DPO A	
Quick Connect Device	25500	Apr 17 2016 17:56:07.706452	PHASE UV2 DPO C	
Quick Connect Device	25499	Apr 17 2016 17:56:07.706452	PHASE UV2 DPO B	
Quick Connect Device	25498	Apr 17 2016 17:56:07.388233	PHASE UV2 PKP C	
Quick Connect Device	25497	Apr 17 2016 17:56:07.388233	PHASE UV2 PKP A	
Quick Connect Device	25496	Apr 17 2016 17:56:07.388233	PHASE UV1 PKP C	
Quick Connect Device	25495	Apr 17 2016 17:56:07.388233	PHASE UV1 PKP A	
Quick Connect Device	25494	Apr 17 2016 17:56:07.382924	27P_pu On	
Quick Connect Device	25493	Apr 17 2016 17:56:07.382924	PHASE UV2 PKP B	
Quick Connect Device	25492	Apr 17 2016 17:56:07.382924	PHASE UV1 PKP B	
Quick Connect Device	25491	Apr 17 2016 17:56:04.717618	81U_pu On	
Quick Connect Device	25490	Apr 17 2016 17:56:04.717618	UNDERFREQ 3 PKP	
Quick Connect Device	25489	Apr 17 2016 17:56:04.717618	UNDERFREQ 2 PKP	
Quick Connect Device	25488	Apr 17 2016 17:56:04.717618	UNDERFREQ 1 PKP	
Quick Connect Device	25487	Apr 17 2016 17:56:04.712475	81U_pu Off	
Quick Connect Device	25486	Apr 17 2016 17:56:04.712475	UNDERFREQ 3 DPO	
Quick Connect Device	25485	Apr 17 2016 17:56:04.712475	UNDERFREQ 2 DPO	
Quick Connect Device	25484	Apr 17 2016 17:56:04.712475	UNDERFREQ 1 DPO	
Quick Connect Device	25483	Apr 17 2016 17:56:04.707330	81U_pu On	
Quick Connect Device	25482	Apr 17 2016 17:56:04.707330	UNDERFREQ 3 PKP	
Quick Connect Device	25481	Apr 17 2016 17:56:04.707330	UNDERFREQ 2 PKP	
Quick Connect Device	25480	Apr 17 2016 17:56:04.707330	UNDERFREQ 1 PKP	
Quick Connect Device	25479	Apr 17 2016 14:02:52.274702	SRC1 VT FF VOLLOSS	
Quick Connect Device	25478	Apr 17 2016 14:02:49.443824	81U_pu Off	
Quick Connect Device	25477	Apr 17 2016 14:02:49.443824	UNDERFREQ 1 DPO	
Quick Connect Device	25476	Apr 17 2016 14:02:47.268804	81U_pu On	
Quick Connect Device	25475	Apr 17 2016 14:02:47.268804	UNDERFREQ 1 PKP	
Quick Connect Device	25474	Apr 17 2016 14:02:41.337748	27P_pu Off	
Quick Connect Device	25473	Apr 17 2016 14:02:41.337748	PHASE UV2 DPO C	

Device	Event	Date/Time	Cause	D
Quick Connect Device	25472	Apr 17 2016 14:02:41.337748	PHASE UV2 DPO B	
Quick Connect Device	25471	Apr 17 2016 14:02:41.337748	PHASE UV2 DPO A	
Quick Connect Device	25470	Apr 17 2016 14:02:41.337748	PHASE UV1 DPO C	
Quick Connect Device	25469	Apr 17 2016 14:02:41.337748	PHASE UV1 DPO B	
Quick Connect Device	25468	Apr 17 2016 14:02:41.337748	PHASE UV1 DPO A	
Quick Connect Device	25467	Apr 17 2016 14:02:41.168605	PHASE UV2 PKP C	
Quick Connect Device	25466	Apr 17 2016 14:02:41.168605	PHASE UV2 PKP B	
Quick Connect Device	25465	Apr 17 2016 14:02:41.168605	PHASE UV2 PKP A	
Quick Connect Device	25464	Apr 17 2016 14:02:41.014205	PHASE UV1 PKP B	
Quick Connect Device	25463	Apr 17 2016 14:02:41.014205	PHASE UV1 PKP A	
Quick Connect Device	25462	Apr 17 2016 14:02:41.009220	27P_pu On	
Quick Connect Device	25461	Apr 17 2016 14:02:41.009220	PHASE UV1 PKP C	
Quick Connect Device	25460	Apr 17 2016 14:02:40.570175	Int_Cerrado Off	
Quick Connect Device	25459	Apr 17 2016 14:02:40.567313	IntCerrado Off	
Quick Connect Device	25458	Apr 17 2016 03:20:45.096940	GEN UNBAL ST G2 DPO	
Quick Connect Device	25457	Apr 17 2016 03:20:45.056975	GEN UNBAL ST G2 PKP	
Quick Connect Device	25456	Apr 17 2016 01:26:20.203959	Bloqueo32R Off	
Quick Connect Device	25455	Apr 17 2016 01:24:50.196755	Bloqueo32R On	
Quick Connect Device	25454	Apr 17 2016 01:24:50.196755	Int_Cerrado On	
Quick Connect Device	25453	Apr 17 2016 01:24:50.193353	IntCerrado On	
Quick Connect Device	25452	Apr 17 2016 01:23:23.727685	81U_pu Off	
Quick Connect Device	25451	Apr 17 2016 01:23:23.727685	UNDERFREQ 1 DPO	
Quick Connect Device	25450	Apr 17 2016 01:23:19.442624	UNDERFREQ 2 DPO	
Quick Connect Device	25449	Apr 17 2016 01:23:17.433114	UNDERFREQ 3 DPO	
Quick Connect Device	25448	Apr 17 2016 01:23:15.959397	27P_pu Off	
Quick Connect Device	25447	Apr 17 2016 01:23:15.959397	PHASE UV1 DPO B	
Quick Connect Device	25446	Apr 17 2016 01:23:15.959397	PHASE UV1 DPO A	
Quick Connect Device	25445	Apr 17 2016 01:23:15.954093	PHASE UV1 DPO C	
Quick Connect Device	25444	Apr 17 2016 01:23:15.624985	PHASE UV2 DPO B	
Quick Connect Device	25443	Apr 17 2016 01:23:15.624985	PHASE UV2 DPO A	
Quick Connect Device	25442	Apr 17 2016 01:23:15.619670	PHASE UV2 DPO C	
Quick Connect Device	25441	Apr 17 2016 01:23:15.300539	PHASE UV2 PKP B	
Quick Connect Device	25440	Apr 17 2016 01:23:15.300539	PHASE UV1 PKP B	
Quick Connect Device	25439	Apr 17 2016 01:23:15.295215	27P_pu On	
Quick Connect Device	25438	Apr 17 2016 01:23:15.295215	PHASE UV2 PKP C	
Quick Connect Device	25437	Apr 17 2016 01:23:15.295215	PHASE UV2 PKP A	
Quick Connect Device	25436	Apr 17 2016 01:23:15.295215	PHASE UV1 PKP C	
Quick Connect Device	25435	Apr 17 2016 01:23:15.295215	PHASE UV1 PKP A	
Quick Connect Device	25434	Apr 17 2016 01:23:12.619045	81U_pu On	
Quick Connect Device	25433	Apr 17 2016 01:23:12.619045	UNDERFREQ 3 PKP	
Quick Connect Device	25432	Apr 17 2016 01:23:12.619045	UNDERFREQ 2 PKP	
Quick Connect Device	25431	Apr 17 2016 01:23:12.619045	UNDERFREQ 1 PKP	
Quick Connect Device	25430	Apr 17 2016 01:23:12.613940	81U_pu Off	
Quick Connect Device	25429	Apr 17 2016 01:23:12.613940	UNDERFREQ 3 DPO	
Quick Connect Device	25428	Apr 17 2016 01:23:12.613940	UNDERFREQ 2 DPO	
Quick Connect Device	25427	Apr 17 2016 01:23:12.613940	UNDERFREQ 1 DPO	
Quick Connect Device	25426	Apr 17 2016 01:23:12.608836	81U_pu On	
Quick Connect Device	25425	Apr 17 2016 01:23:12.608836	UNDERFREQ 3 PKP	
Quick Connect Device	25424	Apr 17 2016 01:23:12.608836	UNDERFREQ 2 PKP	
Quick Connect Device	25423	Apr 17 2016 01:23:12.608836	UNDERFREQ 1 PKP	
Quick Connect Device	25422	Apr 17 2016 01:23:12.603730	81U_pu Off	
Quick Connect Device	25421	Apr 17 2016 01:23:12.603730	UNDERFREQ 3 DPO	
Quick Connect Device	25420	Apr 17 2016 01:23:12.603730	UNDERFREQ 2 DPO	

Device	Event	Date/Time	Cause	D
Quick Connect Device	25419	Apr 17 2016 01:23:12.603730	UNDERFREQ 1 DPO	
Quick Connect Device	25418	Apr 17 2016 01:23:12.598674	81U_pu On	
Quick Connect Device	25417	Apr 17 2016 01:23:12.598674	UNDERFREQ 3 PKP	
Quick Connect Device	25416	Apr 17 2016 01:23:12.598674	UNDERFREQ 2 PKP	
Quick Connect Device	25415	Apr 17 2016 01:23:12.598674	UNDERFREQ 1 PKP	
Quick Connect Device	25414	Apr 17 2016 00:13:18.880208	RESET OP(PUSHBUTT	
Quick Connect Device	25413	Apr 16 2016 21:37:57.611118	SNTP FAILURE	
Quick Connect Device	25412	Apr 16 2016 20:36:27.684397	SNTP FAILURE	
Quick Connect Device	25411	Apr 16 2016 19:20:27.781737	SNTP FAILURE	
Quick Connect Device	25410	Apr 16 2016 19:18:51.064609	Trp86 Off	
Quick Connect Device	25409	Apr 16 2016 19:18:51.064609	Trp Off	
Quick Connect Device	25408	Apr 16 2016 19:18:51.062106	81O_op Off	
Quick Connect Device	25407	Apr 16 2016 19:18:51.062106	OVERFREQ 3 DPO	
Quick Connect Device	25406	Apr 16 2016 19:18:50.562097	81O_pu Off	
Quick Connect Device	25405	Apr 16 2016 19:18:49.401329	SRC1 VT FF VOLLOSS	
Quick Connect Device	25404	Apr 16 2016 19:18:40.791005	Trp86 On	
Quick Connect Device	25403	Apr 16 2016 19:18:40.791005	Trp On	
Quick Connect Device	25402	Apr 16 2016 19:18:40.791005	OSCILLOGRAPHY	
Quick Connect Device	25401	Apr 16 2016 19:18:40.791005	TRIPBUS 1 OP	
Quick Connect Device	25400	Apr 16 2016 19:18:40.791005	TRIPBUS 1 PKP	
Quick Connect Device	25399	Apr 16 2016 19:18:40.789221	81O_op On	
Quick Connect Device	25398	Apr 16 2016 19:18:40.789221	OVERFREQ 3 OP	
Quick Connect Device	25397	Apr 16 2016 19:18:38.096121	27P_pu Off	
Quick Connect Device	25396	Apr 16 2016 19:18:38.096121	27P_op Off	
Quick Connect Device	25395	Apr 16 2016 19:18:38.096121	PHASE UV2 DPO B	
Quick Connect Device	25394	Apr 16 2016 19:18:38.096121	PHASE UV1 DPO B	
Quick Connect Device	25393	Apr 16 2016 19:18:38.071134	PHASE UV2 DPO A	
Quick Connect Device	25392	Apr 16 2016 19:18:38.071134	PHASE UV1 DPO A	
Quick Connect Device	25391	Apr 16 2016 19:18:38.046150	PHASE UV2 DPO C	
Quick Connect Device	25390	Apr 16 2016 19:18:38.046150	PHASE UV1 DPO C	
Quick Connect Device	25389	Apr 16 2016 19:18:37.989037	PHASE UV1 OP A	
Quick Connect Device	25388	Apr 16 2016 19:18:37.917646	27P_op On	
Quick Connect Device	25387	Apr 16 2016 19:18:37.917646	PHASE UV1 OP B	
Quick Connect Device	25386	Apr 16 2016 19:18:37.276280	PHASE UV2 PKP A	
Quick Connect Device	25385	Apr 16 2016 19:18:37.249355	PHASE UV2 PKP C	
Quick Connect Device	25384	Apr 16 2016 19:18:37.230120	PHASE UV2 PKP B	
Quick Connect Device	25383	Apr 16 2016 19:18:36.399555	PHASE UV1 PKP C	
Quick Connect Device	25382	Apr 16 2016 19:18:36.385923	PHASE UV1 DPO C	
Quick Connect Device	25381	Apr 16 2016 19:18:35.786709	OVERFREQ 3 PKP	
Quick Connect Device	25380	Apr 16 2016 19:18:35.786709	OVERFREQ 2 PKP	
Quick Connect Device	25379	Apr 16 2016 19:18:35.641029	81O_pu On	
Quick Connect Device	25378	Apr 16 2016 19:18:35.641029	OVERFREQ 1 PKP	
Quick Connect Device	25377	Apr 16 2016 19:18:35.540385	PHASE UV2 DPO A	
Quick Connect Device	25376	Apr 16 2016 19:18:35.524495	PHASE UV2 DPO C	
Quick Connect Device	25375	Apr 16 2016 19:18:35.508450	PHASE UV2 DPO B	
Quick Connect Device	25374	Apr 16 2016 19:18:35.497754	81U_pu Off	
Quick Connect Device	25373	Apr 16 2016 19:18:35.497754	UNDERFREQ 1 DPO	
Quick Connect Device	25372	Apr 16 2016 19:18:35.438925	PHASE UV2 PKP A	
Quick Connect Device	25371	Apr 16 2016 19:18:35.411916	PHASE UV2 PKP C	
Quick Connect Device	25370	Apr 16 2016 19:18:35.395516	UNDERFREQ 2 DPO	
Quick Connect Device	25369	Apr 16 2016 19:18:35.390007	PHASE UV2 DPO A	
Quick Connect Device	25368	Apr 16 2016 19:18:35.384498	PHASE UV2 PKP B	
Quick Connect Device	25367	Apr 16 2016 19:18:35.356811	UNDERFREQ 3 DPO	

Device	Event	Date/Time	Cause	D
Quick Connect Device	25366	Apr 16 2016 19:18:35.356811	PHASE UV2 PKP A	
Quick Connect Device	25365	Apr 16 2016 19:18:35.334459	Trp86 Off	
Quick Connect Device	25364	Apr 16 2016 19:18:35.334459	Trp Off	
Quick Connect Device	25363	Apr 16 2016 19:18:35.334459	27P_op Off	
Quick Connect Device	25362	Apr 16 2016 19:18:35.334459	PHASE UV2 DPO B	
Quick Connect Device	25361	Apr 16 2016 19:18:35.306263	PHASE UV2 DPO A	
Quick Connect Device	25360	Apr 16 2016 19:18:35.289154	PHASE UV2 DPO C	
Quick Connect Device	25359	Apr 16 2016 19:18:34.847594	GEN UNBAL ST G2 DPO	
Quick Connect Device	25358	Apr 16 2016 19:18:34.847594	NEUTRAL OV1 DPO	
Quick Connect Device	25357	Apr 16 2016 19:18:34.847594	PHASE UV2 PKP C	
Quick Connect Device	25356	Apr 16 2016 19:18:34.823424	50_51P_pu Off	
Quick Connect Device	25355	Apr 16 2016 19:18:34.823424	GEN UNBAL ST G2 PKP	
Quick Connect Device	25354	Apr 16 2016 19:18:34.823424	PHASE TOC1 DPO A	
Quick Connect Device	25353	Apr 16 2016 19:18:34.823424	NEUTRAL OV1 PKP	
Quick Connect Device	25352	Apr 16 2016 19:18:34.823424	PHASE UV2 DPO C	
Quick Connect Device	25351	Apr 16 2016 19:18:34.811339	Int_Cerrado Off	
Quick Connect Device	25350	Apr 16 2016 19:18:34.811339	PHASE TOC1 DPO B	
Quick Connect Device	25349	Apr 16 2016 19:18:34.807478	IntCerrado Off	
Quick Connect Device	25348	Apr 16 2016 19:18:34.793189	PHASE UV2 OP C	
Quick Connect Device	25347	Apr 16 2016 19:18:34.787139	PHASE TOC1 PKP B	
Quick Connect Device	25346	Apr 16 2016 19:18:34.787139	PHASE UV2 OP B	
Quick Connect Device	25345	Apr 16 2016 19:18:34.756845	Trp86 On	
Quick Connect Device	25344	Apr 16 2016 19:18:34.756845	Trp On	
Quick Connect Device	25343	Apr 16 2016 19:18:34.756845	OSCILLOGRAPHY	
Quick Connect Device	25342	Apr 16 2016 19:18:34.756845	27P_op On	
Quick Connect Device	25341	Apr 16 2016 19:18:34.756845	TRIPBUS 1 OP	
Quick Connect Device	25340	Apr 16 2016 19:18:34.756845	TRIPBUS 1 PKP	
Quick Connect Device	25339	Apr 16 2016 19:18:34.756845	PHASE UV2 OP A	
Quick Connect Device	25338	Apr 16 2016 19:18:34.653521	50_51P_pu On	
Quick Connect Device	25337	Apr 16 2016 19:18:34.653521	PHASE TOC1 PKP A	
Quick Connect Device	25336	Apr 16 2016 19:18:33.791779	PHASE UV2 PKP C	
Quick Connect Device	25335	Apr 16 2016 19:18:33.785750	PHASE UV2 PKP B	
Quick Connect Device	25334	Apr 16 2016 19:18:33.755586	PHASE UV2 PKP A	
Quick Connect Device	25333	Apr 16 2016 19:18:33.028672	PHASE UV1 PKP C	
Quick Connect Device	25332	Apr 16 2016 19:18:32.989813	PHASE UV1 PKP A	
Quick Connect Device	25331	Apr 16 2016 19:18:32.918222	27P_pu On	
Quick Connect Device	25330	Apr 16 2016 19:18:32.918222	PHASE UV1 PKP B	
Quick Connect Device	25329	Apr 16 2016 19:18:32.503095	UNDERFREQ 3 PKP	
Quick Connect Device	25328	Apr 16 2016 19:18:32.420712	UNDERFREQ 2 PKP	
Quick Connect Device	25327	Apr 16 2016 19:18:32.273140	81U_pu On	
Quick Connect Device	25326	Apr 16 2016 19:18:32.273140	UNDERFREQ 1 PKP	
Quick Connect Device	25325	Apr 16 2016 19:18:31.892445	81O_pu Off	
Quick Connect Device	25324	Apr 16 2016 19:18:31.838992	27P_pu Off	
Quick Connect Device	25323	Apr 16 2016 19:18:31.838992	PHASE UV1 DPO B	
Quick Connect Device	25322	Apr 16 2016 19:18:31.795373	PHASE UV1 DPO A	
Quick Connect Device	25321	Apr 16 2016 19:18:31.756675	PHASE UV1 DPO C	
Quick Connect Device	25320	Apr 16 2016 19:18:31.602275	50_51P_pu Off	
Quick Connect Device	25319	Apr 16 2016 19:18:31.602275	PHASE TOC1 DPO B	
Quick Connect Device	25318	Apr 16 2016 19:18:31.544399	PHASE TOC1 DPO A	
Quick Connect Device	25317	Apr 16 2016 19:18:31.496095	PHASE TOC1 DPO C	
Quick Connect Device	25316	Apr 16 2016 19:18:31.369521	PHASE TOC1 PKP C	
Quick Connect Device	25315	Apr 16 2016 19:18:31.320104	81O_pu On	
Quick Connect Device	25314	Apr 16 2016 19:18:31.320104	OVERFREQ 2 PKP	

Device	Event	Date/Time	Cause	D
Quick Connect Device	25313	Apr 16 2016 19:18:31.320104	OVERFREQ 1 PKP	
Quick Connect Device	25312	Apr 16 2016 19:18:31.320104	PHASE TOC1 DPO C	
Quick Connect Device	25311	Apr 16 2016 19:18:31.225203	PHASE UV2 DPO C	
Quick Connect Device	25310	Apr 16 2016 19:18:31.220207	50_51P_pu On	
Quick Connect Device	25309	Apr 16 2016 19:18:31.220207	PHASE TOC1 PKP C	
Quick Connect Device	25308	Apr 16 2016 19:18:31.220207	PHASE TOC1 PKP B	
Quick Connect Device	25307	Apr 16 2016 19:18:31.220207	PHASE TOC1 PKP A	
Quick Connect Device	25306	Apr 16 2016 19:18:31.220207	PHASE UV2 DPO B	
Quick Connect Device	25305	Apr 16 2016 19:18:31.220207	PHASE UV2 DPO A	
Quick Connect Device	25304	Apr 16 2016 19:18:31.170247	50_51P_pu Off	
Quick Connect Device	25303	Apr 16 2016 19:18:31.170247	PHASE TOC1 DPO C	
Quick Connect Device	25302	Apr 16 2016 19:18:31.170247	PHASE TOC1 DPO A	
Quick Connect Device	25301	Apr 16 2016 19:18:31.160256	PHASE TOC1 DPO B	
Quick Connect Device	25300	Apr 16 2016 19:18:31.140272	PHASE UV2 PKP C	
Quick Connect Device	25299	Apr 16 2016 19:18:31.140272	PHASE UV1 PKP C	
Quick Connect Device	25298	Apr 16 2016 19:18:31.135277	27P_pu On	
Quick Connect Device	25297	Apr 16 2016 19:18:31.135277	PHASE UV2 PKP B	
Quick Connect Device	25296	Apr 16 2016 19:18:31.135277	PHASE UV2 PKP A	
Quick Connect Device	25295	Apr 16 2016 19:18:31.135277	PHASE UV1 PKP B	
Quick Connect Device	25294	Apr 16 2016 19:18:31.135277	PHASE UV1 PKP A	
Quick Connect Device	25293	Apr 16 2016 19:18:31.090312	50_51P_pu On	
Quick Connect Device	25292	Apr 16 2016 19:18:31.090312	PHASE TOC1 PKP C	
Quick Connect Device	25291	Apr 16 2016 19:18:31.090312	PHASE TOC1 PKP B	
Quick Connect Device	25290	Apr 16 2016 19:18:31.090312	PHASE TOC1 PKP A	
Quick Connect Device	25289	Apr 16 2016 19:18:31.080319	27P_pu Off	
Quick Connect Device	25288	Apr 16 2016 19:18:31.080319	PHASE UV2 DPO B	
Quick Connect Device	25287	Apr 16 2016 19:18:31.080319	PHASE UV2 DPO A	
Quick Connect Device	25286	Apr 16 2016 19:18:31.080319	PHASE UV1 DPO B	
Quick Connect Device	25285	Apr 16 2016 19:18:31.080319	PHASE UV1 DPO A	
Quick Connect Device	25284	Apr 16 2016 19:18:31.075323	PHASE UV2 DPO C	
Quick Connect Device	25283	Apr 16 2016 19:18:31.075323	PHASE UV1 DPO C	
Quick Connect Device	25282	Apr 16 2016 19:18:31.030392	50_51P_pu Off	
Quick Connect Device	25281	Apr 16 2016 19:18:31.030392	PHASE TOC1 DPO C	
Quick Connect Device	25280	Apr 16 2016 19:18:31.030392	PHASE TOC1 DPO B	
Quick Connect Device	25279	Apr 16 2016 19:18:31.030392	PHASE TOC1 DPO A	
Quick Connect Device	25278	Apr 16 2016 19:18:31.015420	PHASE UV2 PKP C	
Quick Connect Device	25277	Apr 16 2016 19:18:31.015420	PHASE UV2 PKP A	
Quick Connect Device	25276	Apr 16 2016 19:18:31.015420	PHASE UV1 PKP C	
Quick Connect Device	25275	Apr 16 2016 19:18:31.015420	PHASE UV1 PKP A	
Quick Connect Device	25274	Apr 16 2016 19:18:31.010429	27P_pu On	
Quick Connect Device	25273	Apr 16 2016 19:18:31.010429	PHASE UV2 PKP B	
Quick Connect Device	25272	Apr 16 2016 19:18:31.010429	PHASE UV1 PKP B	
Quick Connect Device	25271	Apr 16 2016 19:18:30.950544	GEN UNBAL ST G2 DPO	
Quick Connect Device	25270	Apr 16 2016 19:18:30.930582	GEN UNBAL ST G2 PKP	
Quick Connect Device	25269	Apr 16 2016 19:18:30.820704	PHASE IOC1 DPO C	
Quick Connect Device	25268	Apr 16 2016 19:18:30.818206	PHASE IOC1 DPO A	
Quick Connect Device	25267	Apr 16 2016 19:18:30.815709	PHASE IOC1 DPO B	
Quick Connect Device	25266	Apr 16 2016 19:18:30.805715	SRC1 VT FF VOL LOSS	
Quick Connect Device	25265	Apr 16 2016 19:18:30.730763	GEN UNBAL ST G1 DPO	
Quick Connect Device	25264	Apr 16 2016 19:18:30.590766	GEN UNBAL ST G2 DPO	
Quick Connect Device	25263	Apr 16 2016 19:18:30.580775	NEUTRAL OV1 DPO	
Quick Connect Device	25262	Apr 16 2016 19:18:30.578275	PHASE IOC1 PKP A	
Quick Connect Device	25261	Apr 16 2016 19:18:30.575774	PHASE IOC1 PKP B	

Device	Event	Date/Time	Cause	D
Quick Connect Device	25260	Apr 16 2016 19:18:30.570775	50_51P_pu On	
Quick Connect Device	25259	Apr 16 2016 19:18:30.570775	GEN UNBAL ST G2 PKP	
Quick Connect Device	25258	Apr 16 2016 19:18:30.570775	GEN UNBAL ST G1 PKP	
Quick Connect Device	25257	Apr 16 2016 19:18:30.570775	PHASE TOC1 PKP C	
Quick Connect Device	25256	Apr 16 2016 19:18:30.570775	PHASE TOC1 PKP B	
Quick Connect Device	25255	Apr 16 2016 19:18:30.570775	PHASE TOC1 PKP A	
Quick Connect Device	25254	Apr 16 2016 19:18:30.570775	PHASE IOC1 PKP C	
Quick Connect Device	25253	Apr 16 2016 19:18:30.570775	NEUTRAL OV1 PKP	
Quick Connect Device	25252	Apr 15 2016 02:03:14.858346	GEN UNBAL ST G2 DPO	
Quick Connect Device	25251	Apr 15 2016 02:03:14.818232	GEN UNBAL ST G2 PKP	
Quick Connect Device	25250	Apr 14 2016 22:26:23.348685	GEN UNBAL ST G2 DPO	
Quick Connect Device	25249	Apr 14 2016 22:26:23.188381	GEN UNBAL ST G2 PKP	
Quick Connect Device	25248	Apr 14 2016 05:55:31.202385	Bloqueo32R Off	
Quick Connect Device	25247	Apr 14 2016 05:54:01.199505	Bloqueo32R On	
Quick Connect Device	25246	Apr 14 2016 05:54:01.199505	Int_Cerrado On	
Quick Connect Device	25245	Apr 14 2016 05:54:01.195463	IntCerrado On	
Quick Connect Device	25244	Apr 14 2016 05:53:42.332355	81U_pu Off	
Quick Connect Device	25243	Apr 14 2016 05:53:42.332355	UNDERFREQ 1 DPO	
Quick Connect Device	25242	Apr 14 2016 05:53:39.267041	UNDERFREQ 2 DPO	
Quick Connect Device	25241	Apr 14 2016 05:53:38.442101	27P_pu Off	
Quick Connect Device	25240	Apr 14 2016 05:53:38.442101	PHASE UV1 DPO B	
Quick Connect Device	25239	Apr 14 2016 05:53:38.436864	PHASE UV1 DPO C	
Quick Connect Device	25238	Apr 14 2016 05:53:38.436864	PHASE UV1 DPO A	
Quick Connect Device	25237	Apr 14 2016 05:53:38.111836	PHASE UV2 DPO C	
Quick Connect Device	25236	Apr 14 2016 05:53:38.111836	PHASE UV2 DPO A	
Quick Connect Device	25235	Apr 14 2016 05:53:38.106587	PHASE UV2 DPO B	
Quick Connect Device	25234	Apr 14 2016 05:53:37.801770	UNDERFREQ 3 DPO	
Quick Connect Device	25233	Apr 14 2016 05:53:37.796507	27P_pu On	
Quick Connect Device	25232	Apr 14 2016 05:53:37.796507	PHASE UV2 PKP C	
Quick Connect Device	25231	Apr 14 2016 05:53:37.796507	PHASE UV2 PKP B	
Quick Connect Device	25230	Apr 14 2016 05:53:37.796507	PHASE UV2 PKP A	
Quick Connect Device	25229	Apr 14 2016 05:53:37.796507	PHASE UV1 PKP C	
Quick Connect Device	25228	Apr 14 2016 05:53:37.796507	PHASE UV1 PKP B	
Quick Connect Device	25227	Apr 14 2016 05:53:37.796507	PHASE UV1 PKP A	
Quick Connect Device	25226	Apr 14 2016 05:53:35.158566	81U_pu On	
Quick Connect Device	25225	Apr 14 2016 05:53:35.158566	UNDERFREQ 3 PKP	
Quick Connect Device	25224	Apr 14 2016 05:53:35.158566	UNDERFREQ 2 PKP	
Quick Connect Device	25223	Apr 14 2016 05:53:35.158566	UNDERFREQ 1 PKP	
Quick Connect Device	25222	Apr 14 2016 05:53:35.153432	81U_pu Off	
Quick Connect Device	25221	Apr 14 2016 05:53:35.153432	UNDERFREQ 3 DPO	
Quick Connect Device	25220	Apr 14 2016 05:53:35.153432	UNDERFREQ 2 DPO	
Quick Connect Device	25219	Apr 14 2016 05:53:35.153432	UNDERFREQ 1 DPO	
Quick Connect Device	25218	Apr 14 2016 05:53:35.148297	81U_pu On	
Quick Connect Device	25217	Apr 14 2016 05:53:35.148297	UNDERFREQ 3 PKP	
Quick Connect Device	25216	Apr 14 2016 05:53:35.148297	UNDERFREQ 2 PKP	
Quick Connect Device	25215	Apr 14 2016 05:53:35.148297	UNDERFREQ 1 PKP	
Quick Connect Device	25214	Apr 14 2016 04:03:17.352245	SRC1 VT FF VOL LOSS	
Quick Connect Device	25213	Apr 14 2016 04:03:14.645021	81U_pu Off	
Quick Connect Device	25212	Apr 14 2016 04:03:14.645021	UNDERFREQ 3 DPO	
Quick Connect Device	25211	Apr 14 2016 04:03:14.645021	UNDERFREQ 2 DPO	
Quick Connect Device	25210	Apr 14 2016 04:03:14.645021	UNDERFREQ 1 DPO	
Quick Connect Device	25209	Apr 14 2016 04:03:12.955629	UNDERFREQ 3 PKP	
Quick Connect Device	25208	Apr 14 2016 04:03:12.056029	UNDERFREQ 2 PKP	

Device	Event Number	Date/Time	Cause	Data
Quick Connect	52933	Apr 18 2016 12:57:52.984692	PHASE IOC1 OP B	
Quick Connect	52932	Apr 18 2016 12:57:52.984692	PHASE IOC1 PKP B	
Quick Connect	52931	Apr 18 2016 12:57:51.788737	PHASE IOC1 OPA	
Quick Connect	52930	Apr 18 2016 12:57:51.788737	PHASE IOC1 PKP A	
Quick Connect	52929	Apr 18 2016 12:57:51.476639	PHASE IOC1 DPO A	
Quick Connect	52928	Apr 18 2016 12:57:46.824147	PHASE IOC1 OPA	
Quick Connect	52927	Apr 18 2016 12:57:46.824147	PHASE IOC1 PKP A	
Quick Connect	52926	Apr 18 2016 12:57:46.724214	PHASE IOC1 DPO A	
Quick Connect	52925	Apr 18 2016 12:57:45.042503	PHASE IOC1 OPA	
Quick Connect	52924	Apr 18 2016 12:57:45.042503	PHASE IOC1 PKP A	
Quick Connect	52923	Apr 18 2016 12:57:44.647599	PHASE IOC1 DPO A	
Quick Connect	52922	Apr 18 2016 12:57:43.575253	PHASE IOC1 OPA	
Quick Connect	52921	Apr 18 2016 12:57:43.575253	PHASE IOC1 PKP A	
Quick Connect	52920	Apr 18 2016 12:57:43.265256	PHASE IOC1 DPO A	
Quick Connect	52919	Apr 18 2016 12:57:42.537727	PHASE IOC1 OPA	
Quick Connect	52918	Apr 18 2016 12:57:42.537727	PHASE IOC1 PKP A	
Quick Connect	52917	Apr 18 2016 12:57:42.245195	PHASE IOC1 DPO A	
Quick Connect	52916	Apr 18 2016 12:57:37.653526	PHASE IOC1 OPA	
Quick Connect	52915	Apr 18 2016 12:57:37.653526	PHASE IOC1 PKP A	
Quick Connect	52914	Apr 18 2016 12:57:37.590993	PHASE IOC1 DPO A	
Quick Connect	52913	Apr 18 2016 12:57:37.473427	PHASE IOC1 OPA	
Quick Connect	52912	Apr 18 2016 12:57:37.473427	PHASE IOC1 PKP A	
Quick Connect	52911	Apr 18 2016 12:57:37.403392	PHASE IOC1 DPO A	
Quick Connect	52910	Apr 18 2016 12:57:37.255807	PHASE IOC1 OPA	
Quick Connect	52909	Apr 18 2016 12:57:37.255807	PHASE IOC1 PKP A	
Quick Connect	52908	Apr 18 2016 12:57:36.995658	PHASE IOC1 DPO A	
Quick Connect	52907	Apr 18 2016 12:57:35.819964	PHASE IOC1 OPA	
Quick Connect	52906	Apr 18 2016 12:57:35.819964	PHASE IOC1 PKP A	
Quick Connect	52905	Apr 18 2016 12:57:34.804332	PHASE IOC1 DPO A	
Quick Connect	52904	Apr 18 2016 12:57:32.523301	PHASE IOC1 OPA	
Quick Connect	52903	Apr 18 2016 12:57:32.523301	PHASE IOC1 PKP A	
Quick Connect	52902	Apr 18 2016 12:57:32.160703	PHASE IOC1 OP C	
Quick Connect	52901	Apr 18 2016 12:57:32.160703	PHASE IOC1 PKP C	
Quick Connect	52900	Apr 18 2016 12:56:44.176709	DIR POWER 1 STG2 DP	
Quick Connect	52899	Apr 18 2016 12:56:44.176709	DIR POWER 1 STG1 DP	
Quick Connect	52898	Apr 18 2016 12:56:44.136763	DIR POWER 1 STG2 PK	
Quick Connect	52897	Apr 18 2016 12:56:44.136763	DIR POWER 1 STG1 PK	
Quick Connect	52896	Apr 18 2016 12:56:43.997027	DIR POWER 1 STG2 DP	
Quick Connect	52895	Apr 18 2016 12:56:43.997027	DIR POWER 1 STG1 DP	
Quick Connect	52894	Apr 18 2016 12:56:43.957130	PHASE IOC1 DPO B	
Quick Connect	52893	Apr 18 2016 12:56:43.949653	PHASE IOC1 DPO A	
Quick Connect	52892	Apr 18 2016 12:56:43.942174	PHASE IOC1 DPO C	
Quick Connect	52891	Apr 18 2016 12:56:43.917253	DIR POWER 1 STG2 PK	
Quick Connect	52890	Apr 18 2016 12:56:43.917253	DIR POWER 1 STG1 PK	
Quick Connect	52889	Apr 18 2016 12:56:43.912270	PHASE IOC1 OP C	
Quick Connect	52888	Apr 18 2016 12:56:43.912270	PHASE IOC1 PKP C	
Quick Connect	52887	Apr 18 2016 12:56:43.907300	PHASE IOC1 OPA	
Quick Connect	52886	Apr 18 2016 12:56:43.907300	PHASE IOC1 PKP A	
Quick Connect	52885	Apr 18 2016 12:56:43.897324	PHASE IOC1 OP B	
Quick Connect	52884	Apr 18 2016 12:56:43.897324	PHASE IOC1 PKP B	
Quick Connect	52883	Apr 18 2016 12:56:43.877401	PHASE IOC1 DPO C	
Quick Connect	52882	Apr 18 2016 12:56:43.872421	PHASE IOC1 DPO B	
Quick Connect	52881	Apr 18 2016 12:56:43.869930	PHASE IOC1 DPO A	

Device	Event Number	Date/Time	Cause	Data
Quick Connect	52880	Apr 18 2016 12:56:43.832571	PHASE IOC1 OP C	
Quick Connect	52879	Apr 18 2016 12:56:43.832571	PHASE IOC1 PKP C	
Quick Connect	52878	Apr 18 2016 12:56:43.832571	PHASE IOC1 OP B	
Quick Connect	52877	Apr 18 2016 12:56:43.832571	PHASE IOC1 PKP B	
Quick Connect	52876	Apr 18 2016 12:56:43.830081	PHASE IOC1 OPA	
Quick Connect	52875	Apr 18 2016 12:56:43.830081	PHASE IOC1 PKP A	
Quick Connect	52874	Apr 18 2016 12:33:17.156908	RESET OP(PUSHBUTTO	
Quick Connect	52873	Apr 18 2016 12:05:03.706666	RESET OP(PUSHBUTTO	
Quick Connect	52872	Apr 18 2016 09:52:36.434316	Cont Op 8 Off	
Quick Connect	52871	Apr 18 2016 09:52:36.434316	Cont Op 7 Off	
Quick Connect	52870	Apr 18 2016 09:52:36.434316	Cont Op 6 Off	
Quick Connect	52869	Apr 18 2016 09:52:36.434316	Cont Op 4 Off	
Quick Connect	52868	Apr 18 2016 09:52:36.434316	Cont Op 1 Off	
Quick Connect	52867	Apr 18 2016 09:52:36.434316	NOT TRIP On	
Quick Connect	52866	Apr 18 2016 09:52:36.434316	TRIP Off	
Quick Connect	52865	Apr 18 2016 09:52:36.432529	EXT TRIP1 Off	
Quick Connect	52864	Apr 18 2016 09:52:33.289204	Cont Op 8 On	
Quick Connect	52863	Apr 18 2016 09:52:33.289204	Cont Op 7 On	
Quick Connect	52862	Apr 18 2016 09:52:33.289204	Cont Op 6 On	
Quick Connect	52861	Apr 18 2016 09:52:33.289204	Cont Op 4 On	
Quick Connect	52860	Apr 18 2016 09:52:33.289204	Cont Op 1 On	
Quick Connect	52859	Apr 18 2016 09:52:33.289204	OSCILLOGRAPHY TRIG'	
Quick Connect	52858	Apr 18 2016 09:52:33.289204	NOT TRIP Off	
Quick Connect	52857	Apr 18 2016 09:52:33.289204	TRIP On	
Quick Connect	52856	Apr 18 2016 09:52:33.287289	EXT TRIP1 On	
Quick Connect	52855	Apr 18 2016 09:52:32.659679	Cont Op 8 Off	
Quick Connect	52854	Apr 18 2016 09:52:32.659679	Cont Op 7 Off	
Quick Connect	52853	Apr 18 2016 09:52:32.659679	Cont Op 6 Off	
Quick Connect	52852	Apr 18 2016 09:52:32.659679	Cont Op 4 Off	
Quick Connect	52851	Apr 18 2016 09:52:32.659679	Cont Op 1 Off	
Quick Connect	52850	Apr 18 2016 09:52:32.659679	NOT TRIP On	
Quick Connect	52849	Apr 18 2016 09:52:32.659679	TRIP Off	
Quick Connect	52848	Apr 18 2016 09:52:32.654770	PHASE IOC1 DPO C	
Quick Connect	52847	Apr 18 2016 09:52:32.654770	PHASE IOC1 DPO B	
Quick Connect	52846	Apr 18 2016 09:52:32.652315	PHASE IOC1 DPO A	
Quick Connect	52845	Apr 18 2016 09:52:32.649859	PHASE TOC1 DPO C	
Quick Connect	52844	Apr 18 2016 09:52:32.649859	PHASE TOC1 DPO B	
Quick Connect	52843	Apr 18 2016 09:52:32.649859	PHASE TOC1 DPO A	
Quick Connect	52842	Apr 18 2016 09:52:32.640028	LOSS EXCIT STG2 DPO	
Quick Connect	52841	Apr 18 2016 09:52:32.640028	LOSS EXCIT STG1 DPO	
Quick Connect	52840	Apr 18 2016 09:52:32.640028	OVERFREQ 1 DPO	
Quick Connect	52839	Apr 18 2016 09:52:32.640028	PHASE UV1 DPO C	
Quick Connect	52838	Apr 18 2016 09:52:32.640028	PHASE UV1 DPO B	
Quick Connect	52837	Apr 18 2016 09:52:32.640028	PHASE UV1 DPO A	
Quick Connect	52836	Apr 18 2016 09:52:32.522057	DIR POWER 1 STG2 DP	
Quick Connect	52835	Apr 18 2016 09:52:32.522057	DIR POWER 1 STG1 DP	
Quick Connect	52834	Apr 18 2016 09:52:32.502406	DIR POWER 1 STG2 PK	
Quick Connect	52833	Apr 18 2016 09:52:32.502406	DIR POWER 1 STG1 PK	
Quick Connect	52832	Apr 18 2016 09:52:32.482732	Cont Op 8 On	
Quick Connect	52831	Apr 18 2016 09:52:32.482732	Cont Op 7 On	
Quick Connect	52830	Apr 18 2016 09:52:32.482732	Cont Op 6 On	
Quick Connect	52829	Apr 18 2016 09:52:32.482732	Cont Op 4 On	
Quick Connect	52828	Apr 18 2016 09:52:32.482732	Cont Op 1 On	

Device	Event Number	Date/Time	Cause	Data
Quick Connect	52827	Apr 18 2016 09:52:32.482732	OSCILLOGRAPHY TRIG'	
Quick Connect	52826	Apr 18 2016 09:52:32.482732	NOT TRIP Off	
Quick Connect	52825	Apr 18 2016 09:52:32.482732	TRIP On	
Quick Connect	52824	Apr 18 2016 09:52:32.482732	LOSS EXCIT STG1 OP	
Quick Connect	52823	Apr 18 2016 09:52:32.423746	DIR POWER 1 STG2 DP	
Quick Connect	52822	Apr 18 2016 09:52:32.423746	DIR POWER 1 STG1 DP	
Quick Connect	52821	Apr 18 2016 09:52:32.384423	DIR POWER 1 STG2 PK	
Quick Connect	52820	Apr 18 2016 09:52:32.384423	DIR POWER 1 STG1 PK	
Quick Connect	52819	Apr 18 2016 09:52:32.364763	PHASE UV1 PKP C	
Quick Connect	52818	Apr 18 2016 09:52:32.359847	LOSS EXCIT STG2 PKP	
Quick Connect	52817	Apr 18 2016 09:52:32.359847	LOSS EXCIT STG1 PKP	
Quick Connect	52816	Apr 18 2016 09:52:32.359847	PHASE UV1 PKP B	
Quick Connect	52815	Apr 18 2016 09:52:32.359847	PHASE UV1 PKP A	
Quick Connect	52814	Apr 18 2016 09:52:32.305727	PHASE UV1 DPO C	
Quick Connect	52813	Apr 18 2016 09:52:32.305727	PHASE UV1 DPO B	
Quick Connect	52812	Apr 18 2016 09:52:32.300777	PHASE UV1 DPO A	
Quick Connect	52811	Apr 18 2016 09:52:32.295829	OVERFREQ 1 PKP	
Quick Connect	52810	Apr 18 2016 09:52:32.285842	DIR POWER 1 STG2 DP	
Quick Connect	52809	Apr 18 2016 09:52:32.285842	DIR POWER 1 STG1 DP	
Quick Connect	52808	Apr 18 2016 09:52:32.275944	PHASE UV1 PKP C	
Quick Connect	52807	Apr 18 2016 09:52:32.270909	PHASE UV1 PKP A	
Quick Connect	52806	Apr 18 2016 09:52:32.265902	PHASE UV1 PKP B	
Quick Connect	52805	Apr 18 2016 09:52:32.225935	DIR POWER 1 STG2 PK	
Quick Connect	52804	Apr 18 2016 09:52:32.225935	DIR POWER 1 STG1 PK	
Quick Connect	52803	Apr 18 2016 09:52:32.116155	PHASE UV1 DPO C	
Quick Connect	52802	Apr 18 2016 09:52:32.116155	PHASE UV1 DPO B	
Quick Connect	52801	Apr 18 2016 09:52:32.111167	PHASE UV1 DPO A	
Quick Connect	52800	Apr 18 2016 09:52:32.016263	PHASE UV1 PKP B	
Quick Connect	52799	Apr 18 2016 09:52:32.016263	PHASE UV1 PKP A	
Quick Connect	52798	Apr 18 2016 09:52:32.011264	PHASE UV1 PKP C	
Quick Connect	52797	Apr 18 2016 09:52:32.006267	PHASE TOC1 PKP C	
Quick Connect	52796	Apr 18 2016 09:52:32.006267	PHASE TOC1 PKP B	
Quick Connect	52795	Apr 18 2016 09:52:32.006267	PHASE TOC1 PKP A	
Quick Connect	52794	Apr 17 2016 15:20:43.148921	PHASE TOC1 DPO A	
Quick Connect	52793	Apr 17 2016 15:20:43.138924	PHASE TOC1 DPO C	
Quick Connect	52792	Apr 17 2016 15:20:43.138924	PHASE TOC1 PKP A	
Quick Connect	52791	Apr 17 2016 15:20:43.128927	PHASE TOC1 PKP C	
Quick Connect	52790	Apr 17 2016 09:23:01.668226	PHASE IOC1 OP B	
Quick Connect	52789	Apr 17 2016 09:23:01.668226	PHASE IOC1 PKP B	
Quick Connect	52788	Apr 17 2016 09:23:01.448791	PHASE IOC1 OPA	
Quick Connect	52787	Apr 17 2016 09:23:01.448791	PHASE IOC1 PKP A	
Quick Connect	52786	Apr 17 2016 09:22:56.850902	PHASE IOC1 DPO A	
Quick Connect	52785	Apr 17 2016 09:22:55.250145	PHASE IOC1 OPA	
Quick Connect	52784	Apr 17 2016 09:22:55.250145	PHASE IOC1 PKP A	
Quick Connect	52783	Apr 17 2016 09:22:54.876167	PHASE IOC1 OP C	
Quick Connect	52782	Apr 17 2016 09:22:54.876167	PHASE IOC1 PKP C	
Quick Connect	52781	Apr 17 2016 09:21:41.950092	DIR POWER 1 STG2 DP	
Quick Connect	52780	Apr 17 2016 09:21:41.950092	DIR POWER 1 STG1 DP	
Quick Connect	52779	Apr 17 2016 09:21:41.910140	DIR POWER 1 STG2 PK	
Quick Connect	52778	Apr 17 2016 09:21:41.910140	DIR POWER 1 STG1 PK	
Quick Connect	52777	Apr 17 2016 09:21:41.770235	DIR POWER 1 STG2 DP	
Quick Connect	52776	Apr 17 2016 09:21:41.770235	DIR POWER 1 STG1 DP	
Quick Connect	52775	Apr 17 2016 09:21:41.735220	PHASE IOC1 DPO B	

Device	Event Number	Date/Time	Cause	Data
Quick Connect	52774	Apr 17 2016 09:21:41.732720	PHASE IOC1 DPO A	
Quick Connect	52773	Apr 17 2016 09:21:41.725216	PHASE IOC1 DPO C	
Quick Connect	52772	Apr 17 2016 09:21:41.690189	DIR POWER 1 STG2 PK	
Quick Connect	52771	Apr 17 2016 09:21:41.690189	DIR POWER 1 STG1 PK	
Quick Connect	52770	Apr 17 2016 09:21:41.675177	PHASE IOC1 OP C	
Quick Connect	52769	Apr 17 2016 09:21:41.675177	PHASE IOC1 PKP C	
Quick Connect	52768	Apr 17 2016 09:21:41.670172	PHASE IOC1 OP B	
Quick Connect	52767	Apr 17 2016 09:21:41.670172	PHASE IOC1 PKP B	
Quick Connect	52766	Apr 17 2016 09:21:41.670172	PHASE IOC1 OPA	
Quick Connect	52765	Apr 17 2016 09:21:41.670172	PHASE IOC1 PKP A	
Quick Connect	52764	Apr 17 2016 09:21:41.652658	PHASE IOC1 DPO C	
Quick Connect	52763	Apr 17 2016 09:21:41.652658	PHASE IOC1 DPO A	
Quick Connect	52762	Apr 17 2016 09:21:41.650152	PHASE IOC1 DPO B	
Quick Connect	52761	Apr 17 2016 09:21:41.622630	PHASE IOC1 OP C	
Quick Connect	52760	Apr 17 2016 09:21:41.622630	PHASE IOC1 PKP C	
Quick Connect	52759	Apr 17 2016 09:21:41.622630	PHASE IOC1 OPA	
Quick Connect	52758	Apr 17 2016 09:21:41.622630	PHASE IOC1 PKP A	
Quick Connect	52757	Apr 17 2016 09:21:41.620127	PHASE IOC1 OP B	
Quick Connect	52756	Apr 17 2016 09:21:41.620127	PHASE IOC1 PKP B	
Quick Connect	52755	Apr 17 2016 08:57:23.857637	RESET OP(PUSHBUTTO	
Quick Connect	52754	Apr 16 2016 19:43:38.615018	Cont Op 2 Off	
Quick Connect	52753	Apr 16 2016 19:38:08.627516	Cont Op 2 On	
Quick Connect	52752	Apr 16 2016 19:38:08.625015	SNTP FAILURE	
Quick Connect	52751	Apr 16 2016 19:18:34.933690	Cont Op 8 Off	
Quick Connect	52750	Apr 16 2016 19:18:34.933690	Cont Op 7 Off	
Quick Connect	52749	Apr 16 2016 19:18:34.933690	Cont Op 6 Off	
Quick Connect	52748	Apr 16 2016 19:18:34.933690	Cont Op 4 Off	
Quick Connect	52747	Apr 16 2016 19:18:34.933690	Cont Op 1 Off	
Quick Connect	52746	Apr 16 2016 19:18:34.933690	NOT TRIP On	
Quick Connect	52745	Apr 16 2016 19:18:34.933690	TRIP Off	
Quick Connect	52744	Apr 16 2016 19:18:34.931904	EXT TRIP1 Off	
Quick Connect	52743	Apr 16 2016 19:18:31.968824	Cont Op 8 On	
Quick Connect	52742	Apr 16 2016 19:18:31.968824	Cont Op 7 On	
Quick Connect	52741	Apr 16 2016 19:18:31.968824	Cont Op 6 On	
Quick Connect	52740	Apr 16 2016 19:18:31.968824	Cont Op 4 On	
Quick Connect	52739	Apr 16 2016 19:18:31.968824	Cont Op 1 On	
Quick Connect	52738	Apr 16 2016 19:18:31.968824	OSCILLOGRAPHY TRIG'	
Quick Connect	52737	Apr 16 2016 19:18:31.968824	NOT TRIP Off	
Quick Connect	52736	Apr 16 2016 19:18:31.968824	TRIP On	
Quick Connect	52735	Apr 16 2016 19:18:31.966929	EXT TRIP1 On	
Quick Connect	52734	Apr 16 2016 19:18:31.223188	Cont Op 8 Off	
Quick Connect	52733	Apr 16 2016 19:18:31.223188	Cont Op 7 Off	
Quick Connect	52732	Apr 16 2016 19:18:31.223188	Cont Op 6 Off	
Quick Connect	52731	Apr 16 2016 19:18:31.223188	Cont Op 4 Off	
Quick Connect	52730	Apr 16 2016 19:18:31.223188	Cont Op 1 Off	
Quick Connect	52729	Apr 16 2016 19:18:31.223188	NOT TRIP On	
Quick Connect	52728	Apr 16 2016 19:18:31.223188	TRIP Off	
Quick Connect	52727	Apr 16 2016 19:18:31.223188	PHASE IOC1 DPO C	
Quick Connect	52726	Apr 16 2016 19:18:31.223188	PHASE IOC1 DPO A	
Quick Connect	52725	Apr 16 2016 19:18:31.220727	PHASE IOC1 DPO B	
Quick Connect	52724	Apr 16 2016 19:18:31.218265	PHASE TOC1 DPO C	
Quick Connect	52723	Apr 16 2016 19:18:31.218265	PHASE TOC1 DPO B	
Quick Connect	52722	Apr 16 2016 19:18:31.218265	PHASE TOC1 DPO A	

Device	Event Number	Date/Time	Cause	Data
Quick Connect	52721	Apr 16 2016 19:18:31.208419	LOSS EXCIT STG2 DPO	
Quick Connect	52720	Apr 16 2016 19:18:31.208419	OVERFREQ 1 DPO	
Quick Connect	52719	Apr 16 2016 19:18:31.208419	PHASE UV1 DPO B	
Quick Connect	52718	Apr 16 2016 19:18:31.208419	PHASE UV1 DPO A	
Quick Connect	52717	Apr 16 2016 19:18:31.203464	LOSS EXCIT STG1 DPO	
Quick Connect	52716	Apr 16 2016 19:18:31.203464	PHASE UV1 DPO C	
Quick Connect	52715	Apr 16 2016 19:18:31.158869	DIR POWER 1 STG2 DP	
Quick Connect	52714	Apr 16 2016 19:18:31.158869	DIR POWER 1 STG1 DP	
Quick Connect	52713	Apr 16 2016 19:18:31.139049	DIR POWER 1 STG2 PK	
Quick Connect	52712	Apr 16 2016 19:18:31.139049	DIR POWER 1 STG1 PK	
Quick Connect	52711	Apr 16 2016 19:18:31.059764	OVERFREQ 1 PKP	
Quick Connect	52710	Apr 16 2016 19:18:31.049798	Cont Op 8 On	
Quick Connect	52709	Apr 16 2016 19:18:31.049798	Cont Op 7 On	
Quick Connect	52708	Apr 16 2016 19:18:31.049798	Cont Op 6 On	
Quick Connect	52707	Apr 16 2016 19:18:31.049798	Cont Op 4 On	
Quick Connect	52706	Apr 16 2016 19:18:31.049798	Cont Op 1 On	
Quick Connect	52705	Apr 16 2016 19:18:31.049798	OSCILLOGRAPHY TRIG'	
Quick Connect	52704	Apr 16 2016 19:18:31.049798	NOT TRIP Off	
Quick Connect	52703	Apr 16 2016 19:18:31.049798	TRIP On	
Quick Connect	52702	Apr 16 2016 19:18:31.049798	LOSS EXCIT STG1 OP	
Quick Connect	52701	Apr 16 2016 19:18:31.019907	DIR POWER 1 STG2 DP	
Quick Connect	52700	Apr 16 2016 19:18:31.019907	DIR POWER 1 STG1 DP	
Quick Connect	52699	Apr 16 2016 19:18:30.999982	DIR POWER 1 STG2 PK	
Quick Connect	52698	Apr 16 2016 19:18:30.999982	DIR POWER 1 STG1 PK	
Quick Connect	52697	Apr 16 2016 19:18:30.930240	LOSS EXCIT STG1 PKP	
Quick Connect	52696	Apr 16 2016 19:18:30.925259	LOSS EXCIT STG2 PKP	
Quick Connect	52695	Apr 16 2016 19:18:30.925259	PHASE UV1 PKP C	
Quick Connect	52694	Apr 16 2016 19:18:30.925259	PHASE UV1 PKP B	
Quick Connect	52693	Apr 16 2016 19:18:30.925259	PHASE UV1 PKP A	
Quick Connect	52692	Apr 16 2016 19:18:30.880416	DIR POWER 1 STG2 DP	
Quick Connect	52691	Apr 16 2016 19:18:30.880416	DIR POWER 1 STG1 DP	
Quick Connect	52690	Apr 16 2016 19:18:30.875428	PHASE UV1 DPO C	
Quick Connect	52689	Apr 16 2016 19:18:30.865454	PHASE UV1 PKP C	
Quick Connect	52688	Apr 16 2016 19:18:30.800629	DIR POWER 1 STG2 PK	
Quick Connect	52687	Apr 16 2016 19:18:30.800629	DIR POWER 1 STG1 PK	
Quick Connect	52686	Apr 16 2016 19:18:30.671061	PHASE UV1 DPO A	
Quick Connect	52685	Apr 16 2016 19:18:30.666079	PHASE UV1 DPO C	
Quick Connect	52684	Apr 16 2016 19:18:30.666079	PHASE UV1 DPO B	
Quick Connect	52683	Apr 16 2016 19:18:30.581198	PHASE TOC1 PKP B	
Quick Connect	52682	Apr 16 2016 19:18:30.581198	PHASE UV1 PKP B	
Quick Connect	52681	Apr 16 2016 19:18:30.581198	PHASE UV1 PKP A	
Quick Connect	52680	Apr 16 2016 19:18:30.571207	PHASE TOC1 PKP C	
Quick Connect	52679	Apr 16 2016 19:18:30.571207	PHASE TOC1 PKP A	
Quick Connect	52678	Apr 16 2016 19:18:30.566212	PHASE UV1 PKP C	
Quick Connect	52677	Apr 09 2016 11:20:01.564209	PHASE UV1 DPO C	
Quick Connect	52676	Apr 09 2016 11:20:01.559208	PHASE TOC1 DPO C	
Quick Connect	52675	Apr 09 2016 11:20:01.539220	PHASE UV1 PKP C	
Quick Connect	52674	Apr 09 2016 11:20:01.529224	PHASE TOC1 PKP C	
Quick Connect	52673	Apr 01 2016 01:32:11.764004	PHASE TOC1 DPO A	
Quick Connect	52672	Apr 01 2016 01:32:11.759000	PHASE UV1 DPO A	
Quick Connect	52671	Apr 01 2016 01:32:11.713989	PHASE TOC1 PKP A	
Quick Connect	52670	Apr 01 2016 01:32:11.713989	PHASE UV1 PKP A	
Quick Connect	52669	Mar 20 2016 15:27:27.597176	PHASE IOC1 OP B	

florida2 / Folder 1 / RINCON V4.9 Var

MLFB: 7SJ6215**E923FE0
Parameter set version: V04.92.03
Device path: C:\Siemens\DIGSI4\D4PROJ\florida2\P7DI\GV\ST\00000009
Author:
Creation date: 21.04.16 15:55:13
Last modified: 21.04.16 15:56:18
Operating mode: Offline
Comment:
Setting values in: Secondary value description

PRINT - CONTENTS

1	Indications	2
1.1	Avisos de perturbación - 000001 / 16-04-2016 21:05:06.867 - florida2 / Folder 1 / RINCON V4.9 Var/7SJ621	2

1 Indications

1.1 Avisos de perturbación - 000001 / 16-04-2016 21:05:06.867 - florida2 / Folder 1 / RINCON V4.9 Var/7SJ621

Avisos de perturbación - 000001 / 16-04-2016 21:05:06.867 - florida2 / Folder 1 / RINCON V4.9 Var/7SJ621

Number	Indication	Value	Date and time	Cause	State
00301	Falta en Red, numerado	1 - Entra	16.04.2016 21:05:06.867		
00302	Perturbación,evento de faltas	1 - Entra	16.04.2016 21:05:06.867		
00501	Arranque general del relé de protección	Entra	0 ms		
01761	Prot. sobreintens. arranque general	Entra	0 ms		
01765	Arranque prot.sobreintens. tierra (E)	Entra	0 ms		
01834	Arranque sobreintens. escalón IE> tierra	Entra	0 ms		
01762	Arranque prot.sobreintens. fase L1	Entra	6 ms		
01820	Arranque por sobreintensidad escalón Ip	Entra	7 ms		
01763	Arranque prot.sobreintens. fase L2	Entra	17 ms		
00511	Disparo del relé (general)	Entra	45 ms		
01791	Prot. sobreintens. disparo general	Entra	45 ms		
01836	Disparo prot.sobreintens. IE> tierra	Entra	45 ms		
06534	Arranque prot.tens.criterio int., U<	Entra	55 ms		
01764	Arranque prot.sobreintens. fase L3	Entra	70 ms		
00533	Intensidad de falta fase L1 primaria	0,94 kA	84 ms		
00534	Intensidad de falta fase L2 primaria	0,76 kA	84 ms		
00535	Intensidad de falta fase L3 primaria	0,64 kA	84 ms		
06534	Arranque prot.tens.criterio int., U<	Sale	97 ms		
01765	Arranque prot.sobreintens. tierra (E)	Sale	167 ms		
01762	Arranque prot.sobreintens. fase L1	Sale	167 ms		
01763	Arranque prot.sobreintens. fase L2	Sale	167 ms		
01764	Arranque prot.sobreintens. fase L3	Sale	167 ms		
01820	Arranque por sobreintensidad escalón Ip	Sale	167 ms		
01761	Prot. sobreintens. arranque general	Sale	167 ms		
01834	Arranque sobreintens. escalón IE> tierra	Sale	167 ms		
00545	T.transcurrido de arranque a reposición	167 ms	167 ms		
00546	T.transcurrido de arranque a disparo	45 ms	167 ms		
00301	Falta en Red, numerado	1 - Sale	16.04.2016 21:05:07.035		

ProyectoDigi COMP FLOR / Nivel estándar / PROT. DIFF. TRAF0 PODER

MLFB: 7UT61355EB911AB0----0G-----
Versión del juego de parámetros: V04.66.00
Ruta del equipo: C:\Program Files (x86)\Siemens\Step7\s7proj\Proyecto\P7DI\GV\SD\00000049
Autor:
Creado el: 22.02.16 12:51:37
Mod. por última vez el: 19.04.16 09:23:16
Modo de operación: En línea
Comentario:
Valores de ajuste en: Presentación secundaria de los valores

CONTENIDO DE LA IMPRESIÓN

1	Grupos de parámetros	2
1.1	Grupo Power System Data 2; Grupo Power System	2
1.2	Grupo Power System Data 2; Grupo PoleOpen Detect	2
1.3	Grupo Differential Protection; Grupo General	2
1.4	Grupo Differential Protection; Grupo I-Diff	2
1.5	Grupo Differential Protection; Grupo Characteristic	3
1.6	Grupo Differential Protection; Grupo Inrush 2.HM	3
1.7	Grupo Differential Protection; Grupo Restr. n.HM	3
1.8	Grupo Time overcurrent Phase; Grupo General	4
1.9	Grupo Time overcurrent Phase; Grupo DMT	4
1.10	Grupo Time overcurrent Phase; Grupo IDMT	4
1.11	Grupo Time overcurrent Phase; Grupo Inrush	4
1.12	Grupo Time overcurrent 3I0; Grupo General	5
1.13	Grupo Time overcurrent 3I0; Grupo DMT	5
1.14	Grupo Time overcurrent 3I0; Grupo Inrush	5
1.15	Grupo Time overcurrent Earth; Grupo General	5
1.16	Grupo Time overcurrent Earth; Grupo DMT	6
1.17	Grupo Time overcurrent Earth; Grupo IDMT	6
1.18	Grupo Time overcurrent Earth; Grupo Inrush	6
1.19	Grupo Measurement Supervision; Grupo General	6
1.20	Grupo Measurement Supervision; Grupo Balance I M1	7
1.21	Grupo Measurement Supervision; Grupo Balance I M2	7
1.22	Grupo Measurement Supervision; Grupo Balance Voltage	7
1.23	Grupo Supervision; Grupo General	7
2	Annunciation	8
2.1	Event Log - 19-04-2016 9:27:33.729 (SIGNALS\OPSIG.SFP)	8
2.2	Trip Log - 19-04-2016 9:27:37.617 (SIGNALS\FAULTFAULPROT.SFP)	16

1 Grupos de parámetros

1.1 Grupo Power System Data 2; Grupo Power System

Grupo Power System Data 2; Grupo Power System

Nº	Parámetro	Valor	Grupo
1107	sign of P,Q	not reversed	A

1.2 Grupo Power System Data 2; Grupo PoleOpen Detect

Grupo Power System Data 2; Grupo PoleOpen Detect

Nº	Parámetro	Valor	Grupo
1111	Pole Open Current Threshold Side 1	0,10 I/InS	A
1112	Pole Open Current Threshold Side 2	0,10 I/InS	A
1121	Pole Open Current Threshold Meas.Loc. M1	0,20 A	A
1122	Pole Open Current Threshold Meas.Loc. M2	0,20 A	A

1.3 Grupo Differential Protection; Grupo General

Grupo Differential Protection; Grupo General

Nº	Parámetro	Valor	Grupo
1201	Differential Protection	ON	A
1205	Increase of Trip Char. During Start	ON	A
1206	Inrush with 2. Harmonic Restraint	ON	A
1207	n-th Harmonic Restraint	5. Harmonic	A

1.4 Grupo Differential Protection; Grupo I-Diff

Grupo Differential Protection; Grupo I-Diff

Nº	Parámetro	Valor	Grupo
1221	Pickup Value of Differential Curr.	0,30 I/InO	A
1226A	T I-DIFF> Time Delay	0,00 sec	A
1231	Pickup Value of High Set Trip	12,0 I/InO	A
1236A	T I-DIFF>> Time Delay	0,00 sec	A



1.5 Grupo Differential Protection; Grupo Characteristic

Grupo Differential Protection; Grupo Characteristic

Nº	Parámetro	Valor	Grupo
1241A	Slope 1 of Tripping Characteristic	0,30	A
1242A	Base Point for Slope 1 of Charac.	0,00 I/InO	A
1243A	Slope 2 of Tripping Characteristic	0,80	A
1244A	Base Point for Slope 2 of Charac.	2,50 I/InO	A
1251A	I-RESTRAINT for Start Detection	0,25 I/InO	A
1252A	Factor for Increasing of Char. at Start	1,2	A
1253	Maximum Permissible Starting Time	5,0 sec	A
1261A	Pickup for Add-on Stabilization	2,00 I/InO	A
1262A	Duration of Add-on Stabilization	15 Cycle	A
1263A	Time for Cross-blocking Add-on Stabiliz.	15 Cycle	A

1.6 Grupo Differential Protection; Grupo Inrush 2.HM

Grupo Differential Protection; Grupo Inrush 2.HM

Nº	Parámetro	Valor	Grupo
1271	2nd Harmonic Content in I-DIFF	20 %	A
1272A	Time for Cross-blocking 2nd Harm.	3 Cycle	A

1.7 Grupo Differential Protection; Grupo Restr. n.HM

Grupo Differential Protection; Grupo Restr. n.HM

Nº	Parámetro	Valor	Grupo
1276	n-th Harmonic Content in I-DIFF	35 %	A
1277A	Time for Cross-blocking n-th Harm.	3 Cycle	A
1278A	Limit IDIFFmax of n-th Harm.Restrict	12,0 I/InO	A

1.8 Grupo Time overcurrent Phase; Grupo General

Grupo Time overcurrent Phase; Grupo General

Nº	Parámetro	Valor	Grupo
2001	Phase Time Overcurrent	ON	A
2002	InRush Restrained O/C Phase	ON	A
2008A	O/C Manual Close Mode	I>> instantaneously	A

1.9 Grupo Time overcurrent Phase; Grupo DMT

Grupo Time overcurrent Phase; Grupo DMT

Nº	Parámetro	Valor	Grupo
2011	I>> Pickup	10,42 A	A
2013	T I>> Time Delay	oo sec	A
2014	I> Pickup	10,42 A	A
2016	T I> Time Delay	oo sec	A

1.10 Grupo Time overcurrent Phase; Grupo IDMT

Grupo Time overcurrent Phase; Grupo IDMT

Nº	Parámetro	Valor	Grupo
2021	I _p Pickup	6,00 A	A
2023	T I _p Time Dial	0,21 sec	A
2025	TOC Drop-out characteristic	Instantaneous	A
2026	IEC Curve	Very Inverse	A

1.11 Grupo Time overcurrent Phase; Grupo Inrush

Grupo Time overcurrent Phase; Grupo Inrush

Nº	Parámetro	Valor	Grupo
2041	2nd harmonic O/C Ph. in % of fundamental	20 %	A
2042	Maximum Current for Inr. Rest. O/C Phase	33,33 A	A
2044	CROSS BLOCK O/C Phase	YES	A
2045	CROSS BLOCK Time O/C Phase	10,00 sec	A

1.12 Grupo Time overcurrent 3I0; Grupo General

Grupo Time overcurrent 3I0; Grupo General

Nº	Parámetro	Valor	Grupo
2201	3I0 Time Overcurrent	ON	A
2202	InRush Restrained O/C 3I0	ON	A
2208A	O/C 3I0 Manual Close Mode	Inactive	A

1.13 Grupo Time overcurrent 3I0; Grupo DMT

Grupo Time overcurrent 3I0; Grupo DMT

Nº	Parámetro	Valor	Grupo
2211	3I0>> Pickup	83,33 A	A
2213	T 3I0>> Time Delay	oo sec	A
2214	3I0> Pickup	0,38 A	A
2216	T 3I0> Time Delay	0,05 sec	A

1.14 Grupo Time overcurrent 3I0; Grupo Inrush

Grupo Time overcurrent 3I0; Grupo Inrush

Nº	Parámetro	Valor	Grupo
2241	2nd harmonic O/C 3I0 in % of fundamental	20 %	A
2242	Maximum Current for Inr. Rest. O/C 3I0	125,00 A	A

1.15 Grupo Time overcurrent Earth; Grupo General

Grupo Time overcurrent Earth; Grupo General

Nº	Parámetro	Valor	Grupo
2401	Earth Time Overcurrent	ON	A
2402	InRush Restrained O/C Earth	ON	A
2408A	O/C IE Manual Close Mode	Inactive	A

1.16 Grupo Time overcurrent Earth; Grupo DMT

Grupo Time overcurrent Earth; Grupo DMT

Nº	Parámetro	Valor	Grupo
2411	IE>> Pickup	5,00 A	A
2412	T IE>> Time Delay	oo sec	A
2413	IE> Pickup	0,50 A	A
2414	T IE> Time Delay	oo sec	A

1.17 Grupo Time overcurrent Earth; Grupo IDMT

Grupo Time overcurrent Earth; Grupo IDMT

Nº	Parámetro	Valor	Grupo
2421	IEp Pickup	1,00 A	A
2423	D IEp Time Dial	8,60	A
2424	TOC Drop-out Characteristic	Instantaneous	A
2426	ANSI Curve	Very Inverse	A

1.18 Grupo Time overcurrent Earth; Grupo Inrush

Grupo Time overcurrent Earth; Grupo Inrush

Nº	Parámetro	Valor	Grupo
2441	2nd harmonic O/C E in % of fundamental	15 %	A
2442	Maximum Current for Inr. Rest. O/C Earth	37,50 A	A

1.19 Grupo Measurement Supervision; Grupo General

Grupo Measurement Supervision; Grupo General

Nº	Parámetro	Valor	Grupo
8101	Current Balance Supervision	OFF	A
8102	Voltage Balance Supervision	OFF	A
8105	Current Phase Rotation Supervision	OFF	A
8106	Voltage Phase Rotation Supervision	OFF	A

1.20 Grupo Measurement Supervision; Grupo Balance I M1

Grupo Measurement Supervision; Grupo Balance I M1

Nº	Parámetro	Valor	Grupo
8111	Current Balance Monitor Meas. Loc. 1	2,50 A	A
8112	Bal. Factor for Curr. Monitor Meas.Loc.1	0,50	A
8113A	Symmetry Iph: Pick-up delay	5 sec	A

1.21 Grupo Measurement Supervision; Grupo Balance I M2

Grupo Measurement Supervision; Grupo Balance I M2

Nº	Parámetro	Valor	Grupo
8121	Current Balance Monitor Meas. Loc. 2	2,50 A	A
8122	Bal. Factor for Curr. Monitor Meas.Loc.2	0,50	A
8123A	Symmetry Iph: Pick-up delay	5 sec	A

1.22 Grupo Measurement Supervision; Grupo Balance Voltage

Grupo Measurement Supervision; Grupo Balance Voltage

Nº	Parámetro	Valor	Grupo
8161	Voltage Threshold for Balance Monitoring	55 V	A
8162	Balance Factor for Voltage Monitor	0,75	A
8163A	T Balance Factor for Voltage Monitor	5 sec	A

1.23 Grupo Supervision; Grupo General

Grupo Supervision; Grupo General

Nº	Parámetro	Valor	Grupo
8401	Fast broken current-wire supervision	OFF	A
8403	Fuse Failure Monitor	OFF	A
8414	Delay time for BWD supervision	1,0 sec	A
8415	min differential current for BWD	1,00 I/InO	A
8422A	I< for FFM detection M1	0,50 A	A
8423A	I< for FFM detection M2	0,50 A	A
8424A	I< for FFM detection M3	0,50 A	A
2911A	Minimum Voltage Threshold U>	22 V	A
8426A	Maximum Voltage Threshold U< (3phase)	5 V	A

Puntilla / Folder / S_I TRAF0 PODER Var

MLFB: 7SJ6235**B901FE4
Parameter set version: V04.90.05
Device path: C:\Siemens\DIGSI4\D4PROJ\Puntilla\P7DI\GV\ST\00000005
Author:
Creation date: 21.04.16 11:39:37
Last modified: 21.04.16 18:40:10
Operating mode: Offline
Comment:
Setting values in: Secondary value description

PRINT - CONTENTS

1	Settings groups	2
1.1	Group Power System Data 2; Group General	2
1.2	Group DMT / IDMT Phase/Earth Overcurrent; Group General	2
1.3	Group DMT / IDMT Phase/Earth Overcurrent; Group DMT Ph	2
1.4	Group DMT / IDMT Phase/Earth Overcurrent; Group IDMT Ph	3
1.5	Group DMT / IDMT Phase/Earth Overcurrent; Group DMT E	3
1.6	Group DMT / IDMT Phase/Earth Overcurrent; Group IDMT E	4
1.7	Group Measurement Supervision; Group General	4
1.8	Group Measurement Supervision; Group Fuse Fail Mon.	4
1.9	Group Measurement Supervision; Group MeasSupervision	5
1.10	Group Measurement Supervision; Group VT broken wire	5
1.11	Group Energy; Group Measurement	5

1 Settings groups

1.1 Group Power System Data 2; Group General

Group Power System Data 2; Group General

No.	Settings	Value	Group
1101	Measurement: Full Scale Voltage (100%)	12,00 kV	A
1102	Measurement: Full Scale Current (100%)	100 A	A
1108	P,Q operational measured values sign	not reversed	A

1.2 Group DMT / IDMT Phase/Earth Overcurrent; Group General

Group DMT / IDMT Phase/Earth Overcurrent; Group General

No.	Settings	Value	Group
1201	Phase Time Overcurrent	ON	A
1213A	Manual Close Mode	I>> instantaneously	A
1215A	Dropout Time Delay DMT Phase	0,00 sec	A
1301	Earth Time Overcurrent	ON	A
1313A	Manual Close Mode	IE>> instantaneously	A
1315A	Dropout Time Delay DMT Earth	0,00 sec	A

1.3 Group DMT / IDMT Phase/Earth Overcurrent; Group DMT Ph

Group DMT / IDMT Phase/Earth Overcurrent; Group DMT Ph

No.	Settings	Value	Group
1219A	I>>> measurement of	Fundamental component	A
1216A	I>>> active	Always	A
1217	I>>> Pickup	oo A	A
1218	T I>>> Time Delay	0,00 sec	A
1220A	I>> measurement of	Fundamental component	A
1214A	I>> active	Always	A
1202	I>> Pickup	oo A	A
1203	T I>> Time Delay	oo sec	A
1221A	I> measurement of	Fundamental component	A
1204	I> Pickup	oo A	A

Group DMT / IDMT Phase/Earth Overcurrent; Group DMT Ph(2)

No.	Settings	Value	Group
1205	T I> Time Delay	oo sec	A

1.4 Group DMT / IDMT Phase/Earth Overcurrent; Group IDMT Ph

Group DMT / IDMT Phase/Earth Overcurrent; Group IDMT Ph

No.	Settings	Value	Group
1222A	I _p measurement of	Fundamental component	A
1207	I _p Pickup	6,00 A	A
1208	T I _p Time Dial	0,21 sec	A
1210	Drop-Out Characteristic	Instantaneous	A
1211	IEC Curve	Very Inverse	A
1223	Voltage Influence	NO	A
1224	U< Threshold for Release I _p	75,0 V	A

1.5 Group DMT / IDMT Phase/Earth Overcurrent; Group DMT E

Group DMT / IDMT Phase/Earth Overcurrent; Group DMT E

No.	Settings	Value	Group
1319A	IE>>> measurement of	Fundamental component	A
1316A	IE>>> active	Always	A
1317	IE>>> Pickup	oo A	A
1318	T IE>>> Time Delay	0,00 sec	A
1320A	IE>> measurement of	Fundamental component	A
1314A	IE>> active	Always	A
1302	IE>> Pickup	oo A	A
1303	T IE>> Time Delay	oo sec	A
1321A	IE> measurement of	Fundamental component	A
1304	IE> Pickup	0,50 A	A
1305	T IE> Time Delay	oo sec	A

1.6 Group DMT / IDMT Phase/Earth Overcurrent; Group IDMT E

Group DMT / IDMT Phase/Earth Overcurrent; Group IDMT E

No.	Settings	Value	Group
1322A	IEp measurement of	Fundamental component	A
1307	IEp Pickup	1,00 A	A
1309	TIME DIAL: TD	8,60	A
1310	Drop-Out Characteristic	Instantaneous	A
1312	ANSI Curve	Very Inverse	A

1.7 Group Measurement Supervision; Group General

Group Measurement Supervision; Group General

No.	Settings	Value	Group
5301	Fuse Fail Monitor	OFF	A
5310	Block protection by FFM	YES	A
8101	Measurement Supervision	ON	A
5201	VT broken wire supervision	OFF	A

1.8 Group Measurement Supervision; Group Fuse Fail Mon.

Group Measurement Supervision; Group Fuse Fail Mon.

No.	Settings	Value	Group
5302	Zero Sequence Voltage	36 V	A
5303	Residual Current	0,50 A	A
5308A	Delta Current Threshold (3phase)	0,50 A	A

1.9 Group Measurement Supervision; Group MeasSupervision

Group Measurement Supervision; Group MeasSupervision

No.	Settings	Value	Group
8102	Voltage Threshold for Balance Monitoring	60 V	A
8103	Balance Factor for Voltage Monitor	0,75	A
8104	Current Balance Monitor	2,50 A	A
8105	Balance Factor for Current Monitor	0,50	A
8110A	T Balance Factor for Voltage Monitor	5 sec	A
8111A	T Current Balance Monitor	5 sec	A

1.10 Group Measurement Supervision; Group VT broken wire

Group Measurement Supervision; Group VT broken wire

No.	Settings	Value	Group
5202	Threshold voltage sum	10,0 V	A
5203	Maximum phase to phase voltage	19,0 V	A
5204	Minimum phase to phase voltage	19,0 V	A
5205	Symmetry phase to phase voltages	19,0 V	A
5206	Minimum line current	0,20 A	A
5208	Alarm delay time	1,25 sec	A

1.11 Group Energy; Group Measurement

Group Energy; Group Measurement

No.	Settings	Value	Group
8315	Meter resolution	Standard	A

Puntilla / Folder / FLORIDA 1 Var

MLFB: 7SJ6215**E901FC0
Parameter set version: V04.90.05
Device path: C:\Siemens\DIGSI4\D4PROJ\Puntilla\P7DI\GV\ST\00000007
Author:
Creation date: 21.04.16 11:40:20
Last modified: 21.04.16 17:13:58
Operating mode: Offline
Comment:
Setting values in: Secondary value description

PRINT - CONTENTS

1	Settings groups	2
1.1	Group Datos Generales de planta 2; Group General	2..
1.2	Group Protección sobreintensidad; Group General	2..
1.3	Group Protección sobreintensidad; Group S/I t.def. fase	2..
1.4	Group Protección sobreintensidad; Group S/I t.inv. fase	3..
1.5	Group Protección sobreintensidad; Group S/I t.def.tierr	3..
1.6	Group Protección sobreintensidad direccional; Group General	4..
1.7	Group Protección sobreintensidad direccional; Group S/I t.def. fas.	4..
1.8	Group Protección sobreintensidad direccional; Group S/I t.inv. fas.	5..
1.9	Group Protección sobreintensidad direccional; Group S/I t.def. tie.	5..
1.10	Group Control de valores de medida; Group General	5..
1.11	Group Control de valores de medida; Group FFM	6..
1.12	Group Control de valores de medida; Group Ctrl. val. med.	6..
1.13	Group Contador de energía; Group Ajuste val.med.	6..

1 Settings groups

1.1 Group Datos Generales de planta 2; Group General

Group Datos Generales de planta 2; Group General

No.	Settings	Value	Group
1101	Tens. nom.de servicio primaria de planta	12,00 kV	A
1102	Int.nom.de servicio primaria de planta	100 A	A
1108	Signo mat. de valores de serv. P,Q	no inverso	A

1.2 Group Protección sobreintensidad; Group General

Group Protección sobreintensidad; Group General

No.	Settings	Value	Group
1201	Prot. sobreintens. fases, t.def./t.inv.	Activar función	A
1213A	Cierre manual fases	I>> sin temporización	A
1215A	S/I t.def fase T retado repos. T RR	0,00 s	A
1301	Prot.sobreint.faltas a tierra,TDefi/TInv	Activar función	A
1313A	Cierre manual, Tierra	IE>> sin temporización	A
1315A	S/I t.def tierra T retado repos. T RR	0,00 s	A

1.3 Group Protección sobreintensidad; Group S/I t.def. fase

Group Protección sobreintensidad; Group S/I t.def. fase

No.	Settings	Value	Group
1219A	Medición I>>> de	Valor efectivo onda fundamental	A
1216A	I>>> activo	siempre	A
1217	Intensidad de arranque I>>>	oo A	A
1218	Temporización T I>>>	0,00 s	A
1220A	Medición I>> de	Valor efectivo onda fundamental	A
1214A	Escalón I>> Activo	siempre	A
1202	Inten.arranque escalón alta intens. I>>	oo A	A
1203	Temporización, escalón alta intens.T I>>	0,00 s	A
1221A	Medición I> de	Valor efectivo onda fundamental	A
1204	Inten.arranque, escalón intensidad. I>	1,35 A	A

Group Protección sobreintensidad; Group S/I t.def. fase(2)

No.	Settings	Value	Group
1205	Temporización, escalón intensidad. T I>	0,00 s	A

1.4 Group Protección sobreintensidad; Group S/I t.inv. fase

Group Protección sobreintensidad; Group S/I t.inv. fase

No.	Settings	Value	Group
1222A	Medición Ip de	Valor efectivo onda fundamental	A
1207	Valor de arranque Ip	1,35 A	A
1208	Factor de tiempo T Ip	0,14 s	A
1210	Reposición con emulación disco S/I t.inv	inmediato	A
1211	Característica disparo S/I t.inv. (IEC)	Inversa	A
1223	Influencia de la tensión en S/I t inv.	No	A
1224	Umbral subtensión para autorización Ip	75,0 V	A

1.5 Group Protección sobreintensidad; Group S/I t.def.tierr

Group Protección sobreintensidad; Group S/I t.def.tierr

No.	Settings	Value	Group
1319A	Medición IE>>> de	Valor efectivo onda fundamental	A
1316A	IE>>> activo	siempre	A
1317	Intensidad de arranque IE>>>	oo A	A
1318	Temporización T IE>>>	0,00 s	A
1320A	Medición IE>> de	Valor efectivo onda fundamental	A
1314A	Escalón IE>> Activo	siempre	A
1302	Intensidad de arranque escalón IE>>	oo A	A
1303	Temporización, escalón T IE>>	0,00 s	A
1321A	Medición IE> de	Valor efectivo onda fundamental	A
1304	Intensidad de arranque escalón IE>	0,50 A	A
1305	Temporización,escalón T IE>	0,60 s	A

1.6 Group Protección sobreintensidad direccional; Group General

Group Protección sobreintensidad direccional; Group General

No.	Settings	Value	Group
1501	Prot.sobreint. de tiempo fases direcc.	Desactivar función	A
1513A	Cierre Manual, Fases	I>> sin tempor.	A
1526	Sentido de dirección I>>>	adelante	A
1523	Sentido de dirección I>>	adelante	A
1524	Sentido de dirección I>	adelante	A
1525	Sentido de dirección Ip	adelante	A
1518A	S/I t.def fase T retado repos. T RR	0,00 s	A
1519A	Ángulo de rotación de la tensión de ref.	45 °	A
1601	Prot.S/I.tiempo,direcc. tierra,TDef/TInv	Activar función	A
1613A	Cierre Manual, Tierra	IE>> sin tempor.	A
1626	Sentido de dirección IE>>>	adelante	A
1623	Sentido de dirección I>>	adelante	A
1624	Sentido de dirección I>	adelante	A
1617	Valores influyentes,determinación direcc	con Ue y Ie	A
1618A	S/I t.def tierra T retado repos. T RR	0,00 s	A
1619A	Ángulo de rotación de la tensión de ref.	-60 °	A

1.7 Group Protección sobreintensidad direccional; Group S/I t.def. fas.

Group Protección sobreintensidad direccional; Group S/I t.def. fas.

No.	Settings	Value	Group
1527A	I>>> Medición de	Valor efectivo onda fundamental	A
1532A	I>>> activa	siempre	A
1528	Intensidad de arranque I>>>	oo A	A
1529	Tiempo de retardo T I>>>	0,00 s	A
1520A	Medición I>> de	Valor efectivo onda fundamental	A
1514A	I>> activo	siempre	A
1502	Intensidad de arranque, escalón, I>>	10,00 A	A
1503	Temporización, escalón T I>>	0,10 s	A
1521A	Medición I> de	Valor efectivo onda fundamental	A
1504	Intensidad de arranque, escalón I>	5,00 A	A
1505	Temporización, escalón T I>	0,50 s	A

1.8 Group Protección sobreintensidad direccional; Group S/I t.inv. fas.

Group Protección sobreintensidad direccional; Group S/I t.inv. fas.

No.	Settings	Value	Group
1522A	Medición Ip de	Valor efectivo onda fundamental	A
1507	Intensidad de arranque, escalón Ip	5,00 A	A
1509	Factor tiempo D (Time dial)	5,00	A
1510	Reposición con emulación disco S/I t.inv	Emulación disco	A
1512	Caract. disparo S/I t. inv (ANSI)	Muy inversa	A

1.9 Group Protección sobreintensidad direccional; Group S/I t.def. tie.

Group Protección sobreintensidad direccional; Group S/I t.def. tie.

No.	Settings	Value	Group
1627A	IE>>> Medición de	Valor efectivo onda fundamental	A
1632A	IE>>> activa	siempre	A
1628	Intensidad de arranque IE>>>	oo A	A
1629	Tiempo de retardo T IE>>>	0,00 s	A
1620A	Medición IE>> de	Valor efectivo onda fundamental	A
1614A	IE>> activo	siempre	A
1602	Intensidad de arranque IE>>	oo A	A
1603	Temporización,escalón T IE>>	0,00 s	A
1621A	Medición IE> de	Valor efectivo onda fundamental	A
1604	Intensidad de arranque IE>	0,50 A	A
1605	Temporización,escalón T IE>	0,30 s	A

1.10 Group Control de valores de medida; Group General

Group Control de valores de medida; Group General

No.	Settings	Value	Group
5301	Fallo fusible (Fuse-Failure-Monitor)	Desactivar función	A
5310	Bloqueo de la protección por FFM	Si	A
8101	Supervisión de valores de medida,	Activar función	A

1.11 Group Control de valores de medida; Group FFM

Group Control de valores de medida; Group FFM

No.	Settings	Value	Group
5302	Control fallo fusible límite 3*U0	30 V	A
5303	Control fallo fusible límite IE	0,50 A	A
5308A	U dif< para fallo de tensión tripolar	0,50 A	A

1.12 Group Control de valores de medida; Group Ctrl. val. med.

Group Control de valores de medida; Group Ctrl. val. med.

No.	Settings	Value	Group
8102	Simetría U: Valor de reacción	50 V	A
8103	Simetría U: Pendiente lín. caract.	0,75	A
8104	Simetría I fases: Valor de reacción	2,50 A	A
8105	Simetría I fases: Pendiente lín. caract.	0,50	A
8110A	Simetría U fase: Temporiz. de arranque	5 s	A
8111A	Simetría I fase: Temporiz. de arranque	5 s	A

1.13 Group Contador de energía; Group Ajuste val.med.

Group Contador de energía; Group Ajuste val.med.

No.	Settings	Value	Group
8315	Escala del Contador de Energia	Escala Standard	A

UNIDAD N1 - C. FLORIDA 2.URS

C:\USERS\CDIAZ\DESKTOP\PROTECCIONES\PROTECCIONES\BACK-UP RELES DE PROTECCION\

DEVICE DEFINITION

FILES

ORDER CODE: G30-N03-HKH-F8L-H6C-M8N-P6D-UXX-WXX
 VERSION: 6.0X
 UR SERIAL NUMBER: AAKC12000239
 SETTINGS SEND TO RELAY: TUESDAY, FEBRUARY 23, 2016 10:28:03
 DESCRIPTION: (NONE)
 TEXT COLOR

RELAY INFORMATION

Main Firmware:	601
Boot Firmware:	301
Relay Serial Number:	AAKC12000239
CPU Serial Number:	A9NC12005352
F8L Module Serial Number	A8LC12015270
H6C Module Serial Number	A6CC12005595
M8N Module Serial Number	A8NC12005554
P6D Module Serial Number	A6DC12006545
UXX Module Serial Number	
Settings Send to Relay	Tuesday, February 23, 2016 10:28:03

PRODUCT SETUP

SECURITY

Command Password	0
Setting Password	0
Command Password Access Timeout	5 min
Setting Password Access Timeout	30 min
Invalid Password Attempts	3
Password Lockout Duration	5 min
Password Access Events	Disabled
Local Setting Authorized	ON
Remote Setting Authorized	ON
Access Authorized Timeout	30 min

DISPLAY PROPERTIES

Flash Message Time	1.0 s
Default Message Timeout	300 s
Default Message Intensity (VFD Only)	25 %
Screen Saver Feature (LCD Only)	Disabled
Screen Saver Wait Time (LCD Only)	30 min
Current Cutoff Level	0.020 pu
Voltage Cutoff Level	1.0 V

COMMUNICATIONS

SERIAL PORTS

RS485 Com2 Baud Rate	19200
RS485 Com2 Parity	None
RS485 Com2 Response Min Time	0 ms

NETWORK

IP Address	192.168. 31. 79
IP Subnet Mask	255.255.255. 0
Gateway IP Address	192.168. 31. 1
OSI Network Address (NSAP)	00 00 00 00 00 00 00 00 00 00 00 00 00 00 00 00 00 00 00 00

MODBUS PROTOCOL

Modbus Slave Address	254
Modbus TCP Port Number	502

DNP PROTOCOL

DNP Channel 1 Port	NETWORK - TCP
DNP Channel 2 Port	NONE
DNP Address	24
DNP Client Address 1	192.168. 31. 86
DNP Client Address 2	0. 0. 0. 0
DNP Client Address 3	0. 0. 0. 0
DNP Client Address 4	0. 0. 0. 0
DNP Client Address 5	0. 0. 0. 0
DNP TCP/UDP Port Number	20000
DNP Unsol Resp Function	Enabled
DNP Unsol Resp Timeout	1 s
DNP Unsol Resp Max Retries	10
DNP Unsol Resp Dest Addr	1
DNP Current Scale Factor	1
DNP Voltage Scale Factor	1
DNP Power Scale Factor	1
DNP Energy Scale Factor	1
DNP Power Factor Scale Factor	1
DNP Other Scale Factor	1
DNP Current Default Deadband	30000
DNP Voltage Default Deadband	30000

UNIDAD N1 - C. FLORIDA 2.URS

C:\USERS\CDIAZ\DESKTOP\PROTECCIONES\PROTECCIONES\BACK-UP RELES DE PROTECCION\

DEVICE DEFINITION

FILES

ORDER CODE: G30-N03-HKH-F8L-H6C-M8N-P6D-UXX-WXX

VERSION: 6.0X

UR SERIAL NUMBER: AAKC12000239

SETTINGS SEND TO RELAY: TUESDAY, FEBRUARY 23, 2016 10:28:03

DESCRIPTION: (NONE)

TEXT COLOR

DNP PROTOCOL (continued from last page)

DNP Power Default Deadband	30000
DNP Energy Default Deadband	30000
DNP Power Factor Default Deadband	30000
DNP Other Default Deadband	30000
DNP Time Sync IIN Period	1440 min
DNP Message Fragment Size	240
DNP Number of Paired Controls	0
DNP TCP Connection Timeout	120 s
DNP Object 1 Default Variation	2
DNP Object 2 Default Variation	2
DNP Object 30 Default Variation	1
DNP Object 20 Default Variation	1
DNP Object 21 Default Variation	1
DNP Object 22 Default Variation	1
DNP Object 23 Default Variation	1
DNP Object 32 Default Variation	1

DNP - IEC104 POINTS LISTS

DNP Binary Input Point 0	IntCerrado Off(P1c)
DNP Binary Input Point 1	IntAbierto Off(P1a)
DNP Binary Input Point 2	81U_op On (VO1)
DNP Binary Input Point 3	81O_op On (VO2)
DNP Binary Input Point 4	NEUTRAL OV1 OP
DNP Binary Input Point 5	PHASE TOC1 OP
DNP Binary Input Point 6	PHASE IOC1 OP
DNP Binary Input Point 7	GROUND TOC1 OP
DNP Binary Input Point 8	GEN UNBAL STG1 OP
DNP Binary Input Point 9	PHASE UV2 OP
DNP Binary Input Point 10	PHASE OV1 OP
DNP Binary Input Point 11	LOSS EXCIT OP
DNP Binary Input Point 12	ACCDNT ENRG OP
DNP Binary Input Point 13	DIR POWER 1 OP
DNP Binary Input Point 14	87G_pu On (VO9)
DNP Binary Input Point 15	Int_Cerrado On (VO10)
DNP Binary Input Point 16	Int_Abierto On (VO11)
DNP Analog Input Point 0	SRC1 Ia RMS
DNP Analog Input Point 1	SRC1 Ia Mag
DNP Analog Input Point 2	SRC1 Ia Angle
DNP Analog Input Point 3	SRC1 Ib RMS
DNP Analog Input Point 4	SRC1 Ib Mag
DNP Analog Input Point 5	SRC1 Ib Angle
DNP Analog Input Point 6	SRC1 Ic RMS
DNP Analog Input Point 7	SRC1 Ic Mag
DNP Analog Input Point 8	SRC1 Ic Angle
DNP Analog Input Point 9	SRC1 In RMS
DNP Analog Input Point 10	SRC1 In Mag
DNP Analog Input Point 11	SRC1 In Angle
DNP Analog Input Point 12	SRC2 Ig RMS
DNP Analog Input Point 13	SRC2 Ig Mag
DNP Analog Input Point 14	SRC2 Ig Angle
DNP Analog Input Point 15	SRC1 Vag RMS
DNP Analog Input Point 16	SRC1 Vag Mag
DNP Analog Input Point 17	SRC1 Vag Angle
DNP Analog Input Point 18	SRC1 Vbg RMS
DNP Analog Input Point 19	SRC1 Vbg Mag
DNP Analog Input Point 20	SRC1 Vbg Angle
DNP Analog Input Point 21	SRC1 Vcg RMS
DNP Analog Input Point 22	SRC1 Vcg Mag
DNP Analog Input Point 23	SRC2 Vcg Angle
DNP Analog Input Point 24	SRC1 Vab RMS
DNP Analog Input Point 25	SRC1 Vab Mag
DNP Analog Input Point 26	SRC1 Vab Angle
DNP Analog Input Point 27	SRC1 Vbc RMS
DNP Analog Input Point 28	SRC1 Vbc Mag
DNP Analog Input Point 29	SRC1 Vbc Angle
DNP Analog Input Point 30	SRC1 Vca RMS
DNP Analog Input Point 31	SRC1 Vca Mag
DNP Analog Input Point 32	SRC1 Vca Angle
DNP Analog Input Point 33	SRC1 P
DNP Analog Input Point 34	SRC1 Pa
DNP Analog Input Point 35	SRC1 Pb

UNIDAD N1 - C. FLORIDA 2.URS

C:\USERS\CDIAZ\DESKTOP\PROTECCIONES\PROTECCIONES\BACK-UP RELES DE PROTECCION\

DEVICE DEFINITION

FILES

ORDER CODE: G30-N03-HKH-F8L-H6C-M8N-P6D-UXX-WXX

VERSION: 6.0X

UR SERIAL NUMBER: AAKC12000239

SETTINGS SEND TO RELAY: TUESDAY, FEBRUARY 23, 2016 10:28:03

DESCRIPTION: (NONE)

TEXT COLOR

DNP - IEC104 POINTS LISTS (continued from last page)

DNP Analog Input Point 36	SRC1	Pc
DNP Analog Input Point 37	SRC1	Q
DNP Analog Input Point 38	SRC1	Qa
DNP Analog Input Point 39	SRC1	Qb
DNP Analog Input Point 40	SRC1	Qc
DNP Analog Input Point 41	SRC1	S
DNP Analog Input Point 42	SRC1	Sa
DNP Analog Input Point 43	SRC1	Sb
DNP Analog Input Point 44	SRC1	Sc
DNP Analog Input Point 45	SRC1	PF
DNP Analog Input Point 46	SRC1	Phase A PF
DNP Analog Input Point 47	SRC1	Phase B PF
DNP Analog Input Point 48	SRC1	Phase C PF
DNP Analog Input Point 49	SRC1	Pos Watthour
DNP Analog Input Point 50	SRC1	Neg Watthour
DNP Analog Input Point 51	SRC1	Pos varh
DNP Analog Input Point 52	SRC1	Neg varh
DNP Analog Input Point 53	SRC1	Frequency
DNP Analog Input Point 54	SRC2	Frequency
DNP Analog Input Point 55	SRC1	I_0 Mag
DNP Analog Input Point 56	SRC1	I_0 Angle
DNP Analog Input Point 57	SRC1	I_1 Mag
DNP Analog Input Point 58	SRC1	I_1 Angle
DNP Analog Input Point 59	SRC1	I_2 Mag
DNP Analog Input Point 60	SRC1	I_2 Angle
DNP Analog Input Point 61	SRC1	V_0 Mag
DNP Analog Input Point 62	SRC1	V_0 Angle
DNP Analog Input Point 63	SRC1	V_1 Mag
DNP Analog Input Point 64	SRC1	V_1 Angle
DNP Analog Input Point 65	SRC1	V_2 Mag
DNP Analog Input Point 66	SRC1	V_2 Angle
DNP Analog Input Point 67	Oscill Num Triggers	
DNP Analog Input Point 68	Communications Group	
DNP Analog Input Point 69	Active Setting Group	
DNP Analog Input Point 70	Tracking Frequency	

IEC 61850

GSSE / GOOSE CONFIGURATION

TRANSMISSION

GENERAL

Default GSSE/GOOSE Update Time	60 s
--------------------------------	------

GSSE

Function	Enabled
ID	GSSEOut
Destination MAC	00 00 00 00 00 00

TX CONFIGURABLE GOOSE

GOOSEOut 1 Function	Enabled
GOOSEOut 1 ID	GOOSEOut_1
GOOSEOut 1 Destination MAC	00 00 00 00 00 00
GOOSEOut 1 VLAN Priority	4
GOOSEOut 1 VLAN ID	0
GOOSEOut 1 ETYPE APPID	0
GOOSEOut 1 ConfRev	1
GOOSEOut 1 Retransmission Curve	Relaxed
GOOSEOut 2 Function	Enabled
GOOSEOut 2 ID	GOOSEOut_2
GOOSEOut 2 Destination MAC	00 00 00 00 00 00
GOOSEOut 2 VLAN Priority	4
GOOSEOut 2 VLAN ID	0
GOOSEOut 2 ETYPE APPID	0
GOOSEOut 2 ConfRev	1
GOOSEOut 2 Retransmission Curve	Relaxed
GOOSEOut 3 Function	Enabled
GOOSEOut 3 ID	GOOSEOut_3
GOOSEOut 3 Destination MAC	00 00 00 00 00 00
GOOSEOut 3 VLAN Priority	4
GOOSEOut 3 VLAN ID	0
GOOSEOut 3 ETYPE APPID	0
GOOSEOut 3 ConfRev	1

UNIDAD N1 - C. FLORIDA 2.URS

C:\USERS\CDIAZ\DESKTOP\PROTECCIONES\PROTECCIONES\BACK-UP RELES DE PROTECCION\

DEVICE DEFINITION

FILES

ORDER CODE: G30-N03-HKH-F8L-H6C-M8N-P6D-UXX-WXX

VERSION: 6.0X

UR SERIAL NUMBER: AAKC12000239

SETTINGS SEND TO RELAY: TUESDAY, FEBRUARY 23, 2016 10:28:03

DESCRIPTION: (NONE)

TEXT COLOR

TX CONFIGURABLE GOOSE (continued from last page)

GOOSEOut 3 Retransmission Curve	Relaxed
GOOSEOut 4 Function	Enabled
GOOSEOut 4 ID	GOOSEOut_4
GOOSEOut 4 Destination MAC	00 00 00 00 00 00
GOOSEOut 4 VLAN Priority	4
GOOSEOut 4 VLAN ID	0
GOOSEOut 4 ETYPE APPID	0
GOOSEOut 4 ConfRev	1
GOOSEOut 4 Retransmission Curve	Relaxed
GOOSEOut 5 Function	Enabled
GOOSEOut 5 ID	GOOSEOut_5
GOOSEOut 5 Destination MAC	00 00 00 00 00 00
GOOSEOut 5 VLAN Priority	4
GOOSEOut 5 VLAN ID	0
GOOSEOut 5 ETYPE APPID	0
GOOSEOut 5 ConfRev	1
GOOSEOut 5 Retransmission Curve	Relaxed
GOOSEOut 6 Function	Enabled
GOOSEOut 6 ID	GOOSEOut_6
GOOSEOut 6 Destination MAC	00 00 00 00 00 00
GOOSEOut 6 VLAN Priority	4
GOOSEOut 6 VLAN ID	0
GOOSEOut 6 ETYPE APPID	0
GOOSEOut 6 ConfRev	1
GOOSEOut 6 Retransmission Curve	Relaxed
GOOSEOut 7 Function	Enabled
GOOSEOut 7 ID	GOOSEOut_7
GOOSEOut 7 Destination MAC	00 00 00 00 00 00
GOOSEOut 7 VLAN Priority	4
GOOSEOut 7 VLAN ID	0
GOOSEOut 7 ETYPE APPID	0
GOOSEOut 7 ConfRev	1
GOOSEOut 7 Retransmission Curve	Relaxed
GOOSEOut 8 Function	Enabled
GOOSEOut 8 ID	GOOSEOut_8
GOOSEOut 8 Destination MAC	00 00 00 00 00 00
GOOSEOut 8 VLAN Priority	4
GOOSEOut 8 VLAN ID	0
GOOSEOut 8 ETYPE APPID	0
GOOSEOut 8 ConfRev	1
GOOSEOut 8 Retransmission Curve	Relaxed

SERVER CONFIGURATION

IEDName	IEDName
Logical Device Instance	LDInst
MMS TCP Port Number	102
LPHD DC PhyNam location	Location

MMXU DEADBANDS

MMXU1: TotW Deadband	10.000 %
MMXU1: TotVAr Deadband	10.000 %
MMXU1: TotVA Deadband	10.000 %
MMXU1: TotPF Deadband	10.000 %
MMXU1: Hz Deadband	10.000 %
MMXU1: PPV phsAB Deadband	10.000 %
MMXU1: PPV phsBC Deadband	10.000 %
MMXU1: PPV phsCA Deadband	10.000 %
MMXU1: PhV phsA Deadband	10.000 %
MMXU1: PhV phsB Deadband	10.000 %
MMXU1: PhV phsC Deadband	10.000 %
MMXU1: A phsA Deadband	10.000 %
MMXU1: A phsB Deadband	10.000 %
MMXU1: A phsC Deadband	10.000 %
MMXU1: A neut Deadband	10.000 %
MMXU1: W phsA Deadband	10.000 %
MMXU1: W phsB Deadband	10.000 %
MMXU1: W phsC Deadband	10.000 %
MMXU1: VAr phsA Deadband	10.000 %
MMXU1: VAr phsB Deadband	10.000 %
MMXU1: VAr phsC Deadband	10.000 %
MMXU1: VA phsA Deadband	10.000 %

UNIDAD N1 - C. FLORIDA 2.URS

C:\USERS\CDIAZ\DESKTOP\PROTECCIONES\PROTECCIONES\BACK-UP RELES DE PROTECCION\

DEVICE DEFINITION

FILES

ORDER CODE: G30-N03-HKH-F8L-H6C-M8N-P6D-UXX-WXX

VERSION: 6.0X

UR SERIAL NUMBER: AAKC12000239

SETTINGS SEND TO RELAY: TUESDAY, FEBRUARY 23, 2016 10:28:03

DESCRIPTION: (NONE)

TEXT COLOR

MMXU DEADBANDS (continued from last page)

MMXU1: VA phsB Deadband	10.000 %
MMXU1: VA phsC Deadband	10.000 %
MMXU1: PF phsA Deadband	10.000 %
MMXU1: PF phsB Deadband	10.000 %
MMXU1: PF phsC Deadband	10.000 %
MMXU2: TotW Deadband	10.000 %
MMXU2: TotVAr Deadband	10.000 %
MMXU2: TotVA Deadband	10.000 %
MMXU2: TotPF Deadband	10.000 %
MMXU2: Hz Deadband	10.000 %
MMXU2: PPV phsAB Deadband	10.000 %
MMXU2: PPV phsBC Deadband	10.000 %
MMXU2: PPV phsCA Deadband	10.000 %
MMXU2: PhV phsA Deadband	10.000 %
MMXU2: PhV phsB Deadband	10.000 %
MMXU2: PhV phsC Deadband	10.000 %
MMXU2: A phsA Deadband	10.000 %
MMXU2: A phsB Deadband	10.000 %
MMXU2: A phsC Deadband	10.000 %
MMXU2: A neut Deadband	10.000 %
MMXU2: W phsA Deadband	10.000 %
MMXU2: W phsB Deadband	10.000 %
MMXU2: W phsC Deadband	10.000 %
MMXU2: VAr phsA Deadband	10.000 %
MMXU2: VAr phsB Deadband	10.000 %
MMXU2: VAr phsC Deadband	10.000 %
MMXU2: VA phsA Deadband	10.000 %
MMXU2: VA phsB Deadband	10.000 %
MMXU2: VA phsC Deadband	10.000 %
MMXU2: PF phsA Deadband	10.000 %
MMXU2: PF phsB Deadband	10.000 %
MMXU2: PF phsC Deadband	10.000 %
MMXU3: TotW Deadband	10.000 %
MMXU3: TotVAr Deadband	10.000 %
MMXU3: TotVA Deadband	10.000 %
MMXU3: TotPF Deadband	10.000 %
MMXU3: Hz Deadband	10.000 %
MMXU3: PPV phsAB Deadband	10.000 %
MMXU3: PPV phsBC Deadband	10.000 %
MMXU3: PPV phsCA Deadband	10.000 %
MMXU3: PhV phsA Deadband	10.000 %
MMXU3: PhV phsB Deadband	10.000 %
MMXU3: PhV phsC Deadband	10.000 %
MMXU3: A phsA Deadband	10.000 %
MMXU3: A phsB Deadband	10.000 %
MMXU3: A phsC Deadband	10.000 %
MMXU3: A neut Deadband	10.000 %
MMXU3: W phsA Deadband	10.000 %
MMXU3: W phsB Deadband	10.000 %
MMXU3: W phsC Deadband	10.000 %
MMXU3: VAr phsA Deadband	10.000 %
MMXU3: VAr phsB Deadband	10.000 %
MMXU3: VAr phsC Deadband	10.000 %
MMXU3: VA phsA Deadband	10.000 %
MMXU3: VA phsB Deadband	10.000 %
MMXU3: VA phsC Deadband	10.000 %
MMXU3: PF phsA Deadband	10.000 %
MMXU3: PF phsB Deadband	10.000 %
MMXU3: PF phsC Deadband	10.000 %
MMXU4: TotW Deadband	10.000 %
MMXU4: TotVAr Deadband	10.000 %
MMXU4: TotVA Deadband	10.000 %
MMXU4: TotPF Deadband	10.000 %
MMXU4: Hz Deadband	10.000 %
MMXU4: PPV phsAB Deadband	10.000 %
MMXU4: PPV phsBC Deadband	10.000 %
MMXU4: PPV phsCA Deadband	10.000 %
MMXU4: PhV phsA Deadband	10.000 %
MMXU4: PhV phsB Deadband	10.000 %
MMXU4: PhV phsC Deadband	10.000 %
MMXU4: A phsA Deadband	10.000 %

UNIDAD N1 - C. FLORIDA 2.URS

C:\USERS\CDIAZ\DESKTOP\PROTECCIONES\PROTECCIONES\BACK-UP RELES DE PROTECCION\

DEVICE DEFINITION

FILES

ORDER CODE: G30-N03-HKH-F8L-H6C-M8N-P6D-UXX-WXX

VERSION: 6.0X

UR SERIAL NUMBER: AAKC12000239

SETTINGS SEND TO RELAY: TUESDAY, FEBRUARY 23, 2016 10:28:03

DESCRIPTION: (NONE)

TEXT COLOR

MMXU DEADBANDS (continued from last page)

MMXU4: A phsB Deadband	10.000 %
MMXU4: A phsC Deadband	10.000 %
MMXU4: A neut Deadband	10.000 %
MMXU4: W phsA Deadband	10.000 %
MMXU4: W phsB Deadband	10.000 %
MMXU4: W phsC Deadband	10.000 %
MMXU4: VAr phsA Deadband	10.000 %
MMXU4: VAr phsB Deadband	10.000 %
MMXU4: VAr phsC Deadband	10.000 %
MMXU4: VA phsA Deadband	10.000 %
MMXU4: VA phsB Deadband	10.000 %
MMXU4: VA phsC Deadband	10.000 %
MMXU4: PF phsA Deadband	10.000 %
MMXU4: PF phsB Deadband	10.000 %
MMXU4: PF phsC Deadband	10.000 %

GGIO1 STATUS CONFIGURATION

Number of Status Points	8
-------------------------	---

GGIO2 CONTROL CONFIGURATION

SPCSO 1 ctlModel	1
SPCSO 2 ctlModel	1
SPCSO 3 ctlModel	1
SPCSO 4 ctlModel	1
SPCSO 5 ctlModel	1
SPCSO 6 ctlModel	1
SPCSO 7 ctlModel	1
SPCSO 8 ctlModel	1
SPCSO 9 ctlModel	1
SPCSO 10 ctlModel	1
SPCSO 11 ctlModel	1
SPCSO 12 ctlModel	1
SPCSO 13 ctlModel	1
SPCSO 14 ctlModel	1
SPCSO 15 ctlModel	1
SPCSO 16 ctlModel	1
SPCSO 17 ctlModel	1
SPCSO 18 ctlModel	1
SPCSO 19 ctlModel	1
SPCSO 20 ctlModel	1
SPCSO 21 ctlModel	1
SPCSO 22 ctlModel	1
SPCSO 23 ctlModel	1
SPCSO 24 ctlModel	1
SPCSO 25 ctlModel	1
SPCSO 26 ctlModel	1
SPCSO 27 ctlModel	1
SPCSO 28 ctlModel	1
SPCSO 29 ctlModel	1
SPCSO 30 ctlModel	1
SPCSO 31 ctlModel	1
SPCSO 32 ctlModel	1
SPCSO 33 ctlModel	1
SPCSO 34 ctlModel	1
SPCSO 35 ctlModel	1
SPCSO 36 ctlModel	1
SPCSO 37 ctlModel	1
SPCSO 38 ctlModel	1
SPCSO 39 ctlModel	1
SPCSO 40 ctlModel	1
SPCSO 41 ctlModel	1
SPCSO 42 ctlModel	1
SPCSO 43 ctlModel	1
SPCSO 44 ctlModel	1
SPCSO 45 ctlModel	1
SPCSO 46 ctlModel	1
SPCSO 47 ctlModel	1
SPCSO 48 ctlModel	1
SPCSO 49 ctlModel	1
SPCSO 50 ctlModel	1
SPCSO 51 ctlModel	1

UNIDAD N1 - C. FLORIDA 2.URS

C:\USERS\CDIAZ\DESKTOP\PROTECCIONES\PROTECCIONES\BACK-UP RELES DE PROTECCION\

DEVICE DEFINITION

FILES

ORDER CODE: G30-N03-HKH-F8L-H6C-M8N-P6D-UXX-WXX

VERSION: 6.0X

UR SERIAL NUMBER: AAKC12000239

SETTINGS SEND TO RELAY: TUESDAY, FEBRUARY 23, 2016 10:28:03

DESCRIPTION: (NONE)

TEXT COLOR

GGIO2 CONTROL CONFIGURATION (continued from last page)

SPCSO 52 ctlModel	1
SPCSO 53 ctlModel	1
SPCSO 54 ctlModel	1
SPCSO 55 ctlModel	1
SPCSO 56 ctlModel	1
SPCSO 57 ctlModel	1
SPCSO 58 ctlModel	1
SPCSO 59 ctlModel	1
SPCSO 60 ctlModel	1
SPCSO 61 ctlModel	1
SPCSO 62 ctlModel	1
SPCSO 63 ctlModel	1
SPCSO 64 ctlModel	1

GGIO4 ANALOG CONFIGURATION

IEC61850 GGIO4 Analogs	4
IEC61850 GGIO4 Analog 1 Value	OFF
IEC61850 GGIO4 Analog 1 db	100.000 %
IEC61850 GGIO4 Analog 1 min	0.000
IEC61850 GGIO4 Analog 1 max	1000000.000
IEC61850 GGIO4 Analog 2 Value	OFF
IEC61850 GGIO4 Analog 2 db	100.000 %
IEC61850 GGIO4 Analog 2 min	0.000
IEC61850 GGIO4 Analog 2 max	1000000.000
IEC61850 GGIO4 Analog 3 Value	OFF
IEC61850 GGIO4 Analog 3 db	100.000 %
IEC61850 GGIO4 Analog 3 min	0.000
IEC61850 GGIO4 Analog 3 max	1000000.000
IEC61850 GGIO4 Analog 4 Value	OFF
IEC61850 GGIO4 Analog 4 db	100.000 %
IEC61850 GGIO4 Analog 4 min	0.000
IEC61850 GGIO4 Analog 4 max	1000000.000
IEC61850 GGIO4 Analog 5 Value	OFF
IEC61850 GGIO4 Analog 5 db	100.000 %
IEC61850 GGIO4 Analog 5 min	0.000
IEC61850 GGIO4 Analog 5 max	1000000.000
IEC61850 GGIO4 Analog 6 Value	OFF
IEC61850 GGIO4 Analog 6 db	100.000 %
IEC61850 GGIO4 Analog 6 min	0.000
IEC61850 GGIO4 Analog 6 max	1000000.000
IEC61850 GGIO4 Analog 7 Value	OFF
IEC61850 GGIO4 Analog 7 db	100.000 %
IEC61850 GGIO4 Analog 7 min	0.000
IEC61850 GGIO4 Analog 7 max	1000000.000
IEC61850 GGIO4 Analog 8 Value	OFF
IEC61850 GGIO4 Analog 8 db	100.000 %
IEC61850 GGIO4 Analog 8 min	0.000
IEC61850 GGIO4 Analog 8 max	1000000.000
IEC61850 GGIO4 Analog 9 Value	OFF
IEC61850 GGIO4 Analog 9 db	100.000 %
IEC61850 GGIO4 Analog 9 min	0.000
IEC61850 GGIO4 Analog 9 max	1000000.000
IEC61850 GGIO4 Analog 10 Value	OFF
IEC61850 GGIO4 Analog 10 db	100.000 %
IEC61850 GGIO4 Analog 10 min	0.000
IEC61850 GGIO4 Analog 10 max	1000000.000
IEC61850 GGIO4 Analog 11 Value	OFF
IEC61850 GGIO4 Analog 11 db	100.000 %
IEC61850 GGIO4 Analog 11 min	0.000
IEC61850 GGIO4 Analog 11 max	1000000.000
IEC61850 GGIO4 Analog 12 Value	OFF
IEC61850 GGIO4 Analog 12 db	100.000 %
IEC61850 GGIO4 Analog 12 min	0.000
IEC61850 GGIO4 Analog 12 max	1000000.000
IEC61850 GGIO4 Analog 13 Value	OFF
IEC61850 GGIO4 Analog 13 db	100.000 %
IEC61850 GGIO4 Analog 13 min	0.000
IEC61850 GGIO4 Analog 13 max	1000000.000
IEC61850 GGIO4 Analog 14 Value	OFF
IEC61850 GGIO4 Analog 14 db	100.000 %
IEC61850 GGIO4 Analog 14 min	0.000

UNIDAD N1 - C. FLORIDA 2.URS

C:\USERS\CDIAZ\DESKTOP\PROTECCIONES\PROTECCIONES\BACK-UP RELES DE PROTECCION\

DEVICE DEFINITION

FILES

ORDER CODE: G30-N03-HKH-F8L-H6C-M8N-P6D-UXX-WXX

VERSION: 6.0X

UR SERIAL NUMBER: AAKC12000239

SETTINGS SEND TO RELAY: TUESDAY, FEBRUARY 23, 2016 10:28:03

DESCRIPTION: (NONE)

TEXT COLOR

GGIO4 ANALOG CONFIGURATION (continued from last page)

IEC61850 GGIO4 Analog 14 max	1000000.000
IEC61850 GGIO4 Analog 15 Value	OFF
IEC61850 GGIO4 Analog 15 db	100.000 %
IEC61850 GGIO4 Analog 15 min	0.000
IEC61850 GGIO4 Analog 15 max	1000000.000
IEC61850 GGIO4 Analog 16 Value	OFF
IEC61850 GGIO4 Analog 16 db	100.000 %
IEC61850 GGIO4 Analog 16 min	0.000
IEC61850 GGIO4 Analog 16 max	1000000.000
IEC61850 GGIO4 Analog 17 Value	OFF
IEC61850 GGIO4 Analog 17 db	100.000 %
IEC61850 GGIO4 Analog 17 min	0.000
IEC61850 GGIO4 Analog 17 max	1000000.000
IEC61850 GGIO4 Analog 18 Value	OFF
IEC61850 GGIO4 Analog 18 db	100.000 %
IEC61850 GGIO4 Analog 18 min	0.000
IEC61850 GGIO4 Analog 18 max	1000000.000
IEC61850 GGIO4 Analog 19 Value	OFF
IEC61850 GGIO4 Analog 19 db	100.000 %
IEC61850 GGIO4 Analog 19 min	0.000
IEC61850 GGIO4 Analog 19 max	1000000.000
IEC61850 GGIO4 Analog 20 Value	OFF
IEC61850 GGIO4 Analog 20 db	100.000 %
IEC61850 GGIO4 Analog 20 min	0.000
IEC61850 GGIO4 Analog 20 max	1000000.000
IEC61850 GGIO4 Analog 21 Value	OFF
IEC61850 GGIO4 Analog 21 db	100.000 %
IEC61850 GGIO4 Analog 21 min	0.000
IEC61850 GGIO4 Analog 21 max	1000000.000
IEC61850 GGIO4 Analog 22 Value	OFF
IEC61850 GGIO4 Analog 22 db	100.000 %
IEC61850 GGIO4 Analog 22 min	0.000
IEC61850 GGIO4 Analog 22 max	1000000.000
IEC61850 GGIO4 Analog 23 Value	OFF
IEC61850 GGIO4 Analog 23 db	100.000 %
IEC61850 GGIO4 Analog 23 min	0.000
IEC61850 GGIO4 Analog 23 max	1000000.000
IEC61850 GGIO4 Analog 24 Value	OFF
IEC61850 GGIO4 Analog 24 db	100.000 %
IEC61850 GGIO4 Analog 24 min	0.000
IEC61850 GGIO4 Analog 24 max	1000000.000
IEC61850 GGIO4 Analog 25 Value	OFF
IEC61850 GGIO4 Analog 25 db	100.000 %
IEC61850 GGIO4 Analog 25 min	0.000
IEC61850 GGIO4 Analog 25 max	1000000.000
IEC61850 GGIO4 Analog 26 Value	OFF
IEC61850 GGIO4 Analog 26 db	100.000 %
IEC61850 GGIO4 Analog 26 min	0.000
IEC61850 GGIO4 Analog 26 max	1000000.000
IEC61850 GGIO4 Analog 27 Value	OFF
IEC61850 GGIO4 Analog 27 db	100.000 %
IEC61850 GGIO4 Analog 27 min	0.000
IEC61850 GGIO4 Analog 27 max	1000000.000
IEC61850 GGIO4 Analog 28 Value	OFF
IEC61850 GGIO4 Analog 28 db	100.000 %
IEC61850 GGIO4 Analog 28 min	0.000
IEC61850 GGIO4 Analog 28 max	1000000.000
IEC61850 GGIO4 Analog 29 Value	OFF
IEC61850 GGIO4 Analog 29 db	100.000 %
IEC61850 GGIO4 Analog 29 min	0.000
IEC61850 GGIO4 Analog 29 max	1000000.000
IEC61850 GGIO4 Analog 30 Value	OFF
IEC61850 GGIO4 Analog 30 db	100.000 %
IEC61850 GGIO4 Analog 30 min	0.000
IEC61850 GGIO4 Analog 30 max	1000000.000
IEC61850 GGIO4 Analog 31 Value	OFF
IEC61850 GGIO4 Analog 31 db	100.000 %
IEC61850 GGIO4 Analog 31 min	0.000
IEC61850 GGIO4 Analog 31 max	1000000.000
IEC61850 GGIO4 Analog 32 Value	OFF
IEC61850 GGIO4 Analog 32 db	100.000 %

UNIDAD N1 - C. FLORIDA 2.URS

C:\USERS\CDIAZ\DESKTOP\PROTECCIONES\PROTECCIONES\BACK-UP RELES DE PROTECCION\

DEVICE DEFINITION

FILES

ORDER CODE: G30-N03-HKH-F8L-H6C-M8N-P6D-UXX-WXX

VERSION: 6.0X

UR SERIAL NUMBER: AAKC12000239

SETTINGS SEND TO RELAY: TUESDAY, FEBRUARY 23, 2016 10:28:03

DESCRIPTION: (NONE)

TEXT COLOR

GGIO4 ANALOG CONFIGURATION (continued from last page)

IEC61850 GGIO4 Analog 32 min	0.000
IEC61850 GGIO4 Analog 32 max	1000000.000

XCBR CONFIGURATION

XCBR1 ST.Loc Operand	OFF
Clear XCBR1 OpCnt	No
XCBR2 ST.Loc Operand	OFF
Clear XCBR2 OpCnt	No
XCBR3 ST.Loc Operand	OFF
Clear XCBR3 OpCnt	No
XCBR4 ST.Loc Operand	OFF
Clear XCBR4 OpCnt	No

XSWI CONFIGURATION

XSWI1 ST.Loc Operand	OFF
XSWI2 ST.Loc Operand	OFF
XSWI3 ST.Loc Operand	OFF
XSWI4 ST.Loc Operand	OFF
XSWI5 ST.Loc Operand	OFF
XSWI6 ST.Loc Operand	OFF
XSWI7 ST.Loc Operand	OFF
XSWI8 ST.Loc Operand	OFF
XSWI9 ST.Loc Operand	OFF
XSWI10 ST.Loc Operand	OFF
XSWI11 ST.Loc Operand	OFF
XSWI12 ST.Loc Operand	OFF
XSWI13 ST.Loc Operand	OFF
XSWI14 ST.Loc Operand	OFF
XSWI15 ST.Loc Operand	OFF
XSWI16 ST.Loc Operand	OFF
Clear XSWI1 OpCnt	No
Clear XSWI2 OpCnt	No
Clear XSWI3 OpCnt	No
Clear XSWI4 OpCnt	No
Clear XSWI5 OpCnt	No
Clear XSWI6 OpCnt	No
Clear XSWI7 OpCnt	No
Clear XSWI8 OpCnt	No
Clear XSWI9 OpCnt	No
Clear XSWI10 OpCnt	No
Clear XSWI11 OpCnt	No
Clear XSWI12 OpCnt	No
Clear XSWI13 OpCnt	No
Clear XSWI14 OpCnt	No
Clear XSWI15 OpCnt	No
Clear XSWI16 OpCnt	No

HTTP

HTTP TCP Port Number	80
----------------------	----

TFTP

TFTP Main UDP Port Number	69
TFTP Data UDP Port Number 1	0
TFTP Data UDP Port Number 2	0

SNTP

Function	Enabled
Server IP Address	192.168. 31.100
UDP Port Number	123

REAL TIME CLOCK

IRIG-B Signal Type	None
Real Time Clock Events	Enabled
Time Zone Offset	-3.0 hr
DST Function	Disabled

OSCILLOGRAPHY

Number Of Records	15
Trigger Mode	Automatic Overwrite
Trigger Position	50 %
Trigger Source	TRIPBUS 1 OP

UNIDAD N1 - C. FLORIDA 2.URS

C:\USERS\CDIAZ\DESKTOP\PROTECCIONES\PROTECCIONES\BACK-UP RELES DE PROTECCION\

DEVICE DEFINITION

FILES

ORDER CODE: G30-N03-HKH-F8L-H6C-M8N-P6D-UXX-WXX
 VERSION: 6.0X
 UR SERIAL NUMBER: AAKC12000239
 SETTINGS SEND TO RELAY: TUESDAY, FEBRUARY 23, 2016 10:28:03
 DESCRIPTION: (NONE)
 TEXT COLOR

OSCILLOGRAPHY (continued from last page)

AC Input Waveforms	16 samples/cycle
Digital Channel 1	TRIPBUS 1 OP
Digital Channel 2	PHASE UV1 OP
Digital Channel 3	PHASE UV2 OP
Digital Channel 4	NEUTRAL OV1 OP
Digital Channel 5	XFMR PCNT DIFF OP
Digital Channel 6	PHASE TOC1 OP
Digital Channel 7	PHASE IOC1 OP
Digital Channel 8	GEN UNBAL STG1 OP
Digital Channel 9	81U_op On (VO1)
Digital Channel 10	81O_op On (VO2)
Digital Channel 11	PHASE OV1 OP
Digital Channel 12	GROUND TOC1 OP
Digital Channel 13	LOSS EXCIT OP
Digital Channel 14	DIR POWER 1 OP

DATA LOGGER

Data Logger Mode	Continuous
Data Logger Trigger	OFF
Rate	60000 msec

USER-PROGRAMMABLE LEADS

TRIP AND ALARMS LEADS

Trip LED Input	TRIPBUS 1 OP
----------------	--------------

USER PROGRAMMABLE LEADS

LED 1: OPERAND	XFMR PCNT DIFF OP
LED 1: TYPE	Latched
LED 2: OPERAND	50_51P_op On (VO3)
LED 2: TYPE	Latched
LED 3: OPERAND	GROUND TOC1 OP
LED 3: TYPE	Latched
LED 4: OPERAND	NEUTRAL OV1 OP
LED 4: TYPE	Latched
LED 5: OPERAND	LOSS EXCIT OP
LED 5: TYPE	Latched
LED 6: OPERAND	GEN UNBAL STG1 OP
LED 6: TYPE	Latched
LED 7: OPERAND	DIR POWER 1 OP
LED 7: TYPE	Latched
LED 8: OPERAND	ACCDNT ENRG OP
LED 8: TYPE	Latched
LED 9: OPERAND	27P_op On (VO4)
LED 9: TYPE	Latched
LED 10: OPERAND	PHASE OV1 OP
LED 10: TYPE	Latched
LED 11: OPERAND	81U_op On (VO1)
LED 11: TYPE	Latched
LED 12: OPERAND	81O_pu On (VO6)
LED 12: TYPE	Latched
LED 13: OPERAND	87G_pu On (VO9)
LED 13: TYPE	Self-Reset
LED 14: OPERAND	50_51P_pu On (VO7)
LED 14: TYPE	Self-Reset
LED 15: OPERAND	GROUND TOC1 PKP
LED 15: TYPE	Self-Reset
LED 16: OPERAND	NEUTRAL OV1 PKP
LED 16: TYPE	Self-Reset
LED 17: OPERAND	LOSS EXCIT PKP
LED 17: TYPE	Self-Reset
LED 18: OPERAND	GEN UNBAL STG1 PKP
LED 18: TYPE	Self-Reset
LED 19: OPERAND	DIR POWER 1 PKP
LED 19: TYPE	Self-Reset
LED 20: OPERAND	ACCDNT ENRG ARMED
LED 20: TYPE	Self-Reset
LED 21: OPERAND	27P_pu On (VO8)
LED 21: TYPE	Self-Reset
LED 22: OPERAND	PHASE OV1 PKP
LED 22: TYPE	Self-Reset
LED 23: OPERAND	81U_pu On (VO5)

UNIDAD N1 - C. FLORIDA 2.URS

C:\USERS\CDIAZ\DESKTOP\PROTECCIONES\PROTECCIONES\BACK-UP RELES DE PROTECCION\

DEVICE DEFINITION

FILES

ORDER CODE: G30-N03-HKH-F8L-H6C-M8N-P6D-UXX-WXX
 VERSION: 6.0X
 UR SERIAL NUMBER: AAKC12000239
 SETTINGS SEND TO RELAY: TUESDAY, FEBRUARY 23, 2016 10:28:03
 DESCRIPTION: (NONE)
 TEXT COLOR

USER PROGRAMMABLE LEADS (continued from last page)

LED 23: TYPE	Self-Reset
LED 24: OPERAND	810_pu On (VO6)
LED 24: TYPE	Self-Reset
LED 25: OPERAND	Int_Abierto On (VO11)
LED 25: TYPE	Self-Reset
LED 26: OPERAND	Int_Cerrado On (VO10)
LED 26: TYPE	Self-Reset
LED 37: OPERAND	Bloqueo32R On (VO12)
LED 37: TYPE	Self-Reset
LED 38: OPERAND	PHASE UV1 OP
LED 38: TYPE	Self-Reset
LED 39: OPERAND	GEN UNBAL STG2 OP
LED 39: TYPE	Self-Reset

USER-PROGRAMMABLE SELF TESTS

Remote Device Off Function	Enabled
Battery Fail Function	Enabled
SNTP Fail Function	Enabled
IRIG B Fail Function	Enabled

USER-DEFINABLE DISPLAYS

USER DISPLAY 1: Top Line	Florida 2
USER DISPLAY 1: Bottom Line	Unidad 1
USER DISPLAY 1: Item 1	0
USER DISPLAY 1: Item 2	0
USER DISPLAY 1: Item 3	0
USER DISPLAY 1: Item 4	0
USER DISPLAY 1: Item 5	0
Invoke and Scroll	OFF

INSTALLATION

Relay Name	Relay-1
------------	---------

SYSTEM SETUP

AC INPUTS

CURRENT

CT F1: Phase CT Primary	1000 A
CT F1: Phase CT Secondary	5 A
CT F1: Ground CT Primary	1 A
CT F1: Ground CT Secondary	1 A
CT M1: Phase CT Primary	1000 A
CT M1: Phase CT Secondary	5 A
CT M1: Ground CT Primary	100 A
CT M1: Ground CT Secondary	5 A
CT M5: Phase CT Primary	1 A
CT M5: Phase CT Secondary	1 A
CT M5: Ground CT Primary	1 A
CT M5: Ground CT Secondary	1 A

VOLTAGE

VT F5: Phase VT Connection	Wye
VT F5: Phase VT Secondary	69.3 V
VT F5: Phase VT Ratio	100.00 :1
VT F5: Auxiliary VT Connection	Vn
VT F5: Auxiliary VT Secondary	69.3 V
VT F5: Auxiliary VT Ratio	100.00 :1

POWER SYSTEM

Nominal Frequency	50 Hz
Phase Rotation	ABC
Reverse Phase Rotation	OFF
Frequency And Phase Reference	FASEGE (SRC 1)
Frequency Tracking Function	Enabled

SIGNAL SOURCES

SOURCE 1: Name	FASEGE
SOURCE 1: Phase CT	F1
SOURCE 1: Ground CT	None
SOURCE 1: Phase VT	F5
SOURCE 1: Auxiliary VT	None
SOURCE 2: Name	NEUTGE

UNIDAD N1 - C. FLORIDA 2.URS

C:\USERS\CDIAZ\DESKTOP\PROTECCIONES\PROTECCIONES\BACK-UP RELES DE PROTECCION\

DEVICE DEFINITION

FILES

ORDER CODE: G30-N03-HKH-F8L-H6C-M8N-P6D-UXX-WXX
 VERSION: 6.0X
 UR SERIAL NUMBER: AAKC12000239
 SETTINGS SEND TO RELAY: TUESDAY, FEBRUARY 23, 2016 10:28:03
 DESCRIPTION: (NONE)
 TEXT COLOR

SIGNAL SOURCES (continued from last page)

SOURCE 2: Phase CT	M1
SOURCE 2: Ground CT	M1
SOURCE 2: Phase VT	None
SOURCE 2: Auxiliary VT	None

TRANSFORMER

GENERAL

Reference Winding Selection	Automatic Selection
Phase Compensation	Internal (software)

WINDINGS

WINDING 1: Source	FASEGE (SRC 1)
WINDING 1: Rated MVA	10.500 MVA
WINDING 1: Nominal Phs-phs Voltage	12.000 kV
WINDING 1: Connection	Wye
WINDING 1: Grounding	Within zone
WINDING 1: Angle Wrt Winding 1	0.0 deg
WINDING 2: Source	NEUTGE (SRC 2)
WINDING 2: Rated MVA	10.500 MVA
WINDING 2: Nominal Phs-phs Voltage	12.000 kV
WINDING 2: Connection	Wye
WINDING 2: Grounding	Within zone
WINDING 2: Angle Wrt Winding 1	0.0 deg

FLEXLOGIC

FLEXLOGIC EQUATION EDITOR

FlexLogic Entry 1	UNDERFREQ 1 OP
FlexLogic Entry 2	UNDERFREQ 2 OP
FlexLogic Entry 3	UNDERFREQ 3 OP
FlexLogic Entry 4	OR(3)
FlexLogic Entry 5	= 81U_op (VO1)
FlexLogic Entry 6	OVERFREQ 1 OP
FlexLogic Entry 7	OVERFREQ 2 OP
FlexLogic Entry 8	OVERFREQ 3 OP
FlexLogic Entry 9	OR(3)
FlexLogic Entry 10	= 81O_op (VO2)
FlexLogic Entry 11	PHASE IOC1 OP
FlexLogic Entry 12	PHASE TOC1 OP
FlexLogic Entry 13	OR(2)
FlexLogic Entry 14	= 50_51P_op (VO3)
FlexLogic Entry 15	PHASE UV1 OP
FlexLogic Entry 16	PHASE UV2 OP
FlexLogic Entry 17	OR(2)
FlexLogic Entry 18	= 27P_op (VO4)
FlexLogic Entry 19	UNDERFREQ 1 PKP
FlexLogic Entry 20	UNDERFREQ 2 PKP
FlexLogic Entry 21	UNDERFREQ 3 PKP
FlexLogic Entry 22	OR(3)
FlexLogic Entry 23	= 81U_pu (VO5)
FlexLogic Entry 24	OVERFREQ 1 PKP
FlexLogic Entry 25	OVERFREQ 2 PKP
FlexLogic Entry 26	OVERFREQ 3 PKP
FlexLogic Entry 27	OR(3)
FlexLogic Entry 28	= 81O_pu (VO6)
FlexLogic Entry 29	PHASE IOC1 PKP
FlexLogic Entry 30	PHASE TOC1 PKP
FlexLogic Entry 31	OR(2)
FlexLogic Entry 32	= 50_51P_pu (VO7)
FlexLogic Entry 33	PHASE UV1 PKP
FlexLogic Entry 34	PHASE UV2 PKP
FlexLogic Entry 35	OR(2)
FlexLogic Entry 36	= 27P_pu (VO8)
FlexLogic Entry 37	XFMR PCNT DIFF PKP A
FlexLogic Entry 38	XFMR PCNT DIFF PKP B
FlexLogic Entry 39	XFMR PCNT DIFF PKP C
FlexLogic Entry 40	OR(3)
FlexLogic Entry 41	= 87G_pu (VO9)
FlexLogic Entry 42	IntAbierto On(P1a)
FlexLogic Entry 43	NOT
FlexLogic Entry 44	IntCerrado On(P1c)
FlexLogic Entry 45	AND(2)

UNIDAD N1 - C. FLORIDA 2.URS

C:\USERS\CDIAZ\DESKTOP\PROTECCIONES\PROTECCIONES\BACK-UP RELES DE PROTECCION\

DEVICE DEFINITION

FILES

ORDER CODE: G30-N03-HKH-F8L-H6C-M8N-P6D-UXX-WXX
 VERSION: 6.0X
 UR SERIAL NUMBER: AAKC12000239
 SETTINGS SEND TO RELAY: TUESDAY, FEBRUARY 23, 2016 10:28:03
 DESCRIPTION: (NONE)
 TEXT COLOR

FLEXLOGIC EQUATION EDITOR (continued from last page)

FlexLogic Entry 46	= Int_Cerrado (VO10)
FlexLogic Entry 47	IntAbierto On(P1a)
FlexLogic Entry 48	IntCerrado On(P1c)
FlexLogic Entry 49	NOT
FlexLogic Entry 50	AND(2)
FlexLogic Entry 51	= Int_Abierto (VO11)
FlexLogic Entry 52	Int_Cerrado On (VO10)
FlexLogic Entry 53	POSITIVE ONE SHOT
FlexLogic Entry 54	TIMER 1
FlexLogic Entry 55	= Bloqueo32R (VO12)
FlexLogic Entry 56	END

FLEXLOGIC TIMERS

Timer 1: Type	second
Timer 1: Pickup Delay	0
Timer 1: Dropout Delay	90

GROUPED ELEMENTS

GROUP 1

TRANSFORMER

PERCENT DIFFERENTIAL [GROUP 1]

Function	Enabled
Pickup	0.200 pu
Slope 1	20 %
Break 1	2.000 pu
Break 2	8.000 pu
Slope 2	80 %
Inrush Inhibit Function	Trad. 2nd
Inrush Inhibit Mode	Per phase
Inrush Inhibit Level	20.0 % fo
Overexcitation Inhibit Function	Disabled
Overexcitation Inhibit Level	10.0 % fo
Block	OFF
Target	Latched
Events	Enabled

PHASE CURRENT

PHASE TOC [GROUP 1]

PHASE TOC1: Function	Enabled
PHASE TOC1: Signal Source	FASEGE (SRC 1)
PHASE TOC1: Input	Phasor
PHASE TOC1: Pickup	0.530 pu
PHASE TOC1: Curve	IEC Curve A
PHASE TOC1: TD Multiplier	0.24
PHASE TOC1: Reset	Instantaneous
PHASE TOC1: Voltage Restraint	Enabled
PHASE TOC1: Block A	OFF
PHASE TOC1: Block B	OFF
PHASE TOC1: Block C	OFF
PHASE TOC1: Target	Self-reset
PHASE TOC1: Events	Enabled

PHASE IOC [GROUP 1]

PHASE IOC1: Function	Enabled
PHASE IOC1: Source	FASEGE (SRC 1)
PHASE IOC1: Pickup	1.500 pu
PHASE IOC1: Delay	0.60 s
PHASE IOC1: Reset Delay	0.00 s
PHASE IOC1: Block A	OFF
PHASE IOC1: Block B	OFF
PHASE IOC1: Block C	OFF
PHASE IOC1: Target	Self-reset
PHASE IOC1: Events	Enabled

GROUND CURRENT

GROUND TOC [GROUP 1]

GROUND TOC1: Function	Enabled
GROUND TOC1: Source	NEUTGE (SRC 2)
GROUND TOC1: Input	Phasor
GROUND TOC1: Pickup	0.530 pu
GROUND TOC1: Curve	IEC Curve A

UNIDAD N1 - C. FLORIDA 2.URS

C:\USERS\CDIAZ\DESKTOP\PROTECCIONES\PROTECCIONES\BACK-UP RELES DE PROTECCION\

DEVICE DEFINITION

FILES

ORDER CODE: G30-N03-HKH-F8L-H6C-M8N-P6D-UXX-WXX

VERSION: 6.0X

UR SERIAL NUMBER: AAKC12000239

SETTINGS SEND TO RELAY: TUESDAY, FEBRUARY 23, 2016 10:28:03

DESCRIPTION: (NONE)

TEXT COLOR

GROUND TOC [GROUP 1] (continued from last page)

GROUND TOC1: TD Multiplier	0.25
GROUND TOC1: Reset	Instantaneous
GROUND TOC1: Block	OFF
GROUND TOC1: Target	Self-reset
GROUND TOC1: Events	Enabled

GENERATOR UNBALANCE [GROUP 1]

Function	Enabled
Source	FASEGE (SRC 1)
Inom	0.505 pu
Stage 1 Pickup	19.00 %
Stage 1 K-Value	30.00
Stage 1 Tmin	0.250 s
Stage 1 Tmax	600.0 s
Stage 1 K-Reset	240.0 s
Stage 2 Pickup	7.00 %
Stage 2 Pickup Delay	1.0 s
Block	OFF
Target	Self-reset
Events	Enabled

VOLTAGE ELEMENTS

PHASE UV [GROUP 1]

PHASE UV1: Function	Enabled
PHASE UV1: Signal Source	FASEGE (SRC 1)
PHASE UV1: Mode	Phase to Phase
PHASE UV1: Pickup	0.920 pu
PHASE UV1: Curve	Definite Time
PHASE UV1: Delay	5.00 s
PHASE UV1: Minimum Voltage	0.700 pu
PHASE UV1: Block	OFF
PHASE UV1: Target	Self-reset
PHASE UV1: Events	Enabled
PHASE UV2: Function	Enabled
PHASE UV2: Signal Source	FASEGE (SRC 1)
PHASE UV2: Mode	Phase to Phase
PHASE UV2: Pickup	0.800 pu
PHASE UV2: Curve	Definite Time
PHASE UV2: Delay	1.00 s
PHASE UV2: Minimum Voltage	0.700 pu
PHASE UV2: Block	OFF
PHASE UV2: Target	Self-reset
PHASE UV2: Events	Enabled

PHASE OV [GROUP 1]

PHASE OV1: Function	Enabled
PHASE OV1: Source	FASEGE (SRC 1)
PHASE OV1: Pickup	1.110 pu
PHASE OV1: Delay	2.00 s
PHASE OV1: Reset Delay	1.00 s
PHASE OV1: Block	OFF
PHASE OV1: Target	Self-reset
PHASE OV1: Events	Enabled

NEUTRAL OV [GROUP 1]

NEUTRAL OV 1: Function	Enabled
NEUTRAL OV 1: Source	FASEGE (SRC 1)
NEUTRAL OV 1: Pickup	0.100 pu
NEUTRAL OV 1: Curve	Definite Time
NEUTRAL OV 1: Pickup Delay	1.00 s
NEUTRAL OV 1: Reset Delay	1.00 s
NEUTRAL OV 1: Block	OFF
NEUTRAL OV 1: Target	Self-reset
NEUTRAL OV 1: Events	Enabled

LOSS OF EXCITATION [GROUP 1]

Function	Enabled
Source	FASEGE (SRC 1)
Center 1	9.05 ohm
Radius 1	6.86 ohm
UV Supervision Enable 1	Disabled

UNIDAD N1 - C. FLORIDA 2.URS

C:\USERS\CDIAZ\DESKTOP\PROTECCIONES\PROTECCIONES\BACK-UP RELES DE PROTECCION\

DEVICE DEFINITION

FILES

ORDER CODE: G30-N03-HKH-F8L-H6C-M8N-P6D-UXX-WXX
 VERSION: 6.0X
 UR SERIAL NUMBER: AAKC12000239
 SETTINGS SEND TO RELAY: TUESDAY, FEBRUARY 23, 2016 10:28:03
 DESCRIPTION: (NONE)
 TEXT COLOR

LOSS OF EXCITATION [GROUP 1] (continued from last page)

Pickup Delay 1	0.100 s
Center 2	11.11 ohm
Radius 2	8.91 ohm
UV Supervision Enable 2	Disabled
Pickup Delay 2	0.600 s
UV Supervision	0.700 pu
Block	OFF
Target	Self-reset
Events	Enabled

ACCIDENTAL ENERGIZATION [GROUP 1]

Function	Enabled
Source	FASEGE (SRC 1)
Accidental Energization Arming Mode	UV AND OFFLINE
Accidental Energization OC Pickup	0.300
Accidental Energization UV Pickup	0.500
Accidental Energization Offline	Virt Ip 10 On (VI10)
Block	OFF
Target	Self-reset
Events	Enabled

STATOR GROUND

STATOR GROUND SOURCE [GROUP 1]

Source	FASEGE (SRC 1)
--------	----------------

POWER

SENSITIVE DIRECTIONAL POWER

SENSITIVE DIRECTIONAL POWER [GROUP 1]

SENS DIR POWER1: Function	Enabled
SENS DIR POWER1: Signal Source	FASEGE (SRC 1)
SENS DIR POWER1: Sensitive Directional Power RCA	180 deg
SENS DIR POWER1: Sensitive Directional Power Calibration	0.00 deg
SENS DIR POWER1: Stage 1 SMIN	0.021 pu
SENS DIR POWER1: Stage 1 Delay	30.00 s
SENS DIR POWER1: Stage 2 SMIN	0.050 pu
SENS DIR POWER1: Stage 2 Delay	5.00 s
SENS DIR POWER1: Block	Bloqueo32R On (VO12)
SENS DIR POWER1: Target	Self-reset
SENS DIR POWER1: Events	Enabled

CONTROL ELEMENTS

TRIP BUS

Trip Bus 1 Function	Enabled
Trip Bus 1 Block	OFF
Trip Bus 1 Pickup Delay	0.00 s
Trip Bus 1 Reset Delay	0.00 s
Trip Bus 1 Input 1	XFMR PCNT DIFF OP
Trip Bus 1 Input 2	81U_op On (VO1)
Trip Bus 1 Input 3	81O_op On (VO2)
Trip Bus 1 Input 4	NEUTRAL OV1 OP
Trip Bus 1 Input 5	PHASE TOC1 OP
Trip Bus 1 Input 6	PHASE IOC1 OP
Trip Bus 1 Input 7	GROUND TOC1 OP
Trip Bus 1 Input 8	GEN UNBAL STG1 OP
Trip Bus 1 Input 9	OFF
Trip Bus 1 Input 10	PHASE UV2 OP
Trip Bus 1 Input 11	PHASE OV1 OP
Trip Bus 1 Input 12	LOSS EXCIT OP
Trip Bus 1 Input 13	ACCDNT ENRG OP
Trip Bus 1 Input 14	DIR POWER 1 OP
Trip Bus 1 Input 15	OFF
Trip Bus 1 Input 16	OFF
Trip Bus 1 Latching	Disabled
Trip Bus 1 Reset	OFF
Trip Bus 1 Target	Self-reset
Trip Bus 1 Events	Enabled

UNDERFREQUENCY

UNDERFREQUENCY 1: Function	Enabled
UNDERFREQUENCY 1: Block	OFF
UNDERFREQUENCY 1: Source	FASEGE (SRC 1)

UNIDAD N1 - C. FLORIDA 2.URS

C:\USERS\CDIAZ\DESKTOP\PROTECCIONES\PROTECCIONES\BACK-UP RELES DE PROTECCION\

DEVICE DEFINITION

FILES

ORDER CODE: G30-N03-HKH-F8L-H6C-M8N-P6D-UXX-WXX
 VERSION: 6.0X
 UR SERIAL NUMBER: AAKC12000239
 SETTINGS SEND TO RELAY: TUESDAY, FEBRUARY 23, 2016 10:28:03
 DESCRIPTION: (NONE)
 TEXT COLOR

UNDERFREQUENCY (continued from last page)

UNDERFREQUENCY 1: Min Volt/Amp	0.10 pu
UNDERFREQUENCY 1: Pickup	49.00 Hz
UNDERFREQUENCY 1: Pickup Delay	65.535 s
UNDERFREQUENCY 1: Reset Delay	2.000 s
UNDERFREQUENCY 1: Target	Self-reset
UNDERFREQUENCY 1: Events	Enabled
UNDERFREQUENCY 2: Function	Enabled
UNDERFREQUENCY 2: Block	OFF
UNDERFREQUENCY 2: Source	FASEGE (SRC 1)
UNDERFREQUENCY 2: Min Volt/Amp	0.10 pu
UNDERFREQUENCY 2: Pickup	48.00 Hz
UNDERFREQUENCY 2: Pickup Delay	15.000 s
UNDERFREQUENCY 2: Reset Delay	2.000 s
UNDERFREQUENCY 2: Target	Self-reset
UNDERFREQUENCY 2: Events	Enabled
UNDERFREQUENCY 3: Function	Enabled
UNDERFREQUENCY 3: Block	OFF
UNDERFREQUENCY 3: Source	FASEGE (SRC 1)
UNDERFREQUENCY 3: Min Volt/Amp	0.10 pu
UNDERFREQUENCY 3: Pickup	47.50 Hz
UNDERFREQUENCY 3: Pickup Delay	5.000 s
UNDERFREQUENCY 3: Reset Delay	2.000 s
UNDERFREQUENCY 3: Target	Self-reset
UNDERFREQUENCY 3: Events	Enabled

OVERFREQUENCY

OVERFREQUENCY 1: Function	Enabled
OVERFREQUENCY 1: Block	OFF
OVERFREQUENCY 1: Source	FASEGE (SRC 1)
OVERFREQUENCY 1: Pickup	51.00 Hz
OVERFREQUENCY 1: Pickup Delay	65.535 s
OVERFREQUENCY 1: Reset Delay	0.500 s
OVERFREQUENCY 1: Target	Self-reset
OVERFREQUENCY 1: Events	Enabled
OVERFREQUENCY 2: Function	Enabled
OVERFREQUENCY 2: Block	OFF
OVERFREQUENCY 2: Source	FASEGE (SRC 1)
OVERFREQUENCY 2: Pickup	52.00 Hz
OVERFREQUENCY 2: Pickup Delay	15.000 s
OVERFREQUENCY 2: Reset Delay	0.500 s
OVERFREQUENCY 2: Target	Self-reset
OVERFREQUENCY 2: Events	Enabled
OVERFREQUENCY 3: Function	Enabled
OVERFREQUENCY 3: Block	OFF
OVERFREQUENCY 3: Source	FASEGE (SRC 1)
OVERFREQUENCY 3: Pickup	52.50 Hz
OVERFREQUENCY 3: Pickup Delay	5.000 s
OVERFREQUENCY 3: Reset Delay	0.500 s
OVERFREQUENCY 3: Target	Self-reset
OVERFREQUENCY 3: Events	Enabled

MONITORING ELEMENTS

VT FUSE FAILURE

VT FUSE FAILURE 1: Function	Enabled
VT FUSE FAILURE 1: Neutral Wire Open Detection	Disabled
VT FUSE FAILURE 1: 3rd Harmonic Pickup	0.100 pu

FREQUENCY OOB ACCUMULATION

Freq OOB Accumulator Source	FASEGE (SRC 1)
Freq OOB Accumulator Min V A	0.10 pu
Freq OOB Accumulator Block	OFF
Freq OOB Accumulator Target	Self-reset
Freq OOB Accumulator Events	Disabled

INPUTS/OUTPUTS

CONTACT INPUTS

[PIA] Contact Input 1 ID	IntAbierto
[PIA] Contact Input 1 Debounce Time	2.0 ms
[PIA] Contact Input 1 Events	Enabled
[PIC] Contact Input 2 ID	IntCerrado
[PIC] Contact Input 2 Debounce Time	2.0 ms

UNIDAD N1 - C. FLORIDA 2.URS

C:\USERS\CDIAZ\DESKTOP\PROTECCIONES\PROTECCIONES\BACK-UP RELES DE PROTECCION\

DEVICE DEFINITION

FILES

ORDER CODE: G30-N03-HKH-F8L-H6C-M8N-P6D-UXX-WXX

VERSION: 6.0X

UR SERIAL NUMBER: AAKC12000239

SETTINGS SEND TO RELAY: TUESDAY, FEBRUARY 23, 2016 10:28:03

DESCRIPTION: (NONE)

TEXT COLOR

CONTACT INPUTS (continued from last page)

[P1C] Contact Input 2 Events	Enabled
[P2A] Contact Input 3 ID	Cont Ip 3
[P2A] Contact Input 3 Debounce Time	2.0 ms
[P2A] Contact Input 3 Events	Disabled
[P2C] Contact Input 4 ID	Cont Ip 4
[P2C] Contact Input 4 Debounce Time	2.0 ms
[P2C] Contact Input 4 Events	Disabled
[P3A] Contact Input 5 ID	Cont Ip 5
[P3A] Contact Input 5 Debounce Time	2.0 ms
[P3A] Contact Input 5 Events	Disabled
[P3C] Contact Input 6 ID	Cont Ip 6
[P3C] Contact Input 6 Debounce Time	2.0 ms
[P3C] Contact Input 6 Events	Disabled
[P4A] Contact Input 7 ID	Cont Ip 7
[P4A] Contact Input 7 Debounce Time	2.0 ms
[P4A] Contact Input 7 Events	Disabled
[P4C] Contact Input 8 ID	Cont Ip 8
[P4C] Contact Input 8 Debounce Time	2.0 ms
[P4C] Contact Input 8 Events	Disabled
[P5A] Contact Input 9 ID	Cont Ip 9
[P5A] Contact Input 9 Debounce Time	2.0 ms
[P5A] Contact Input 9 Events	Disabled
[P5C] Contact Input 10 ID	Cont Ip 10
[P5C] Contact Input 10 Debounce Time	2.0 ms
[P5C] Contact Input 10 Events	Disabled
[P6A] Contact Input 11 ID	Cont Ip 11
[P6A] Contact Input 11 Debounce Time	2.0 ms
[P6A] Contact Input 11 Events	Disabled
[P6C] Contact Input 12 ID	Cont Ip 12
[P6C] Contact Input 12 Debounce Time	2.0 ms
[P6C] Contact Input 12 Events	Disabled
[P7A] Contact Input 13 ID	Cont Ip 13
[P7A] Contact Input 13 Debounce Time	2.0 ms
[P7A] Contact Input 13 Events	Disabled
[P7C] Contact Input 14 ID	Cont Ip 14
[P7C] Contact Input 14 Debounce Time	2.0 ms
[P7C] Contact Input 14 Events	Disabled
[P8A] Contact Input 15 ID	Cont Ip 15
[P8A] Contact Input 15 Debounce Time	2.0 ms
[P8A] Contact Input 15 Events	Disabled
[P8C] Contact Input 16 ID	Cont Ip 16
[P8C] Contact Input 16 Debounce Time	2.0 ms
[P8C] Contact Input 16 Events	Disabled

CONTACT INPUT THRESHOLDS

IntAbierto, IntCerrado, Cont Ip 3, Cont Ip 4(P1a, P1c, P2a, P2c)	84 Vdc
Cont Ip 5, Cont Ip 6, Cont Ip 7, Cont Ip 8(P3a, P3c, P4a, P4c)	84 Vdc
Cont Ip 9, Cont Ip 10, Cont Ip 11, Cont Ip 12(P5a, P5c, P6a, P6c)	84 Vdc
Cont Ip 13, Cont Ip 14, Cont Ip 15, Cont Ip 16(P7a, P7c, P8a, P8c)	84 Vdc

CONTACT OUTPUTS

[H1] Contact Output 1 ID	Trip
[H1] Contact Output 1 Operate	TRIPBUS 1 OP
[H1] Contact Output 1 Seal-In	OFF
[H1] Contact Output 1 Events	Enabled
[H2] Contact Output 2 ID	Trip86
[H2] Contact Output 2 Operate	TRIPBUS 1 OP
[H2] Contact Output 2 Seal-In	OFF
[H2] Contact Output 2 Events	Enabled
[H3] Contact Output 3 ID	Alarma46
[H3] Contact Output 3 Operate	GEN UNBAL STG1 OP
[H3] Contact Output 3 Seal-In	OFF
[H3] Contact Output 3 Events	Enabled
[H4] Contact Output 4 ID	Alarma40
[H4] Contact Output 4 Operate	LOSS EXCIT OP
[H4] Contact Output 4 Seal-In	OFF
[H4] Contact Output 4 Events	Enabled
[H5] Contact Output 5 ID	Alarma51P
[H5] Contact Output 5 Operate	50_51P_op On (VO3)
[H5] Contact Output 5 Seal-In	OFF
[H5] Contact Output 5 Events	Enabled

UNIDAD N1 - C. FLORIDA 2.URS

C:\USERS\CDIAZ\DESKTOP\PROTECCIONES\PROTECCIONES\BACK-UP RELES DE PROTECCION\

DEVICE DEFINITION

FILES

ORDER CODE: G30-N03-HKH-F8L-H6C-M8N-P6D-UXX-WXX

VERSION: 6.0X

UR SERIAL NUMBER: AAKC12000239

SETTINGS SEND TO RELAY: TUESDAY, FEBRUARY 23, 2016 10:28:03

DESCRIPTION: (NONE)

TEXT COLOR

CONTACT OUTPUTS (continued from last page)

[H6] Contact Output 6 ID	Alarma51N
[H6] Contact Output 6 Operate	GROUND TOC1 OP
[H6] Contact Output 6 Seal-In	OFF
[H6] Contact Output 6 Events	Enabled
[H7] Contact Output 7 ID	Alarma87
[H7] Contact Output 7 Operate	XFMR PCNT DIFF OP
[H7] Contact Output 7 Seal-In	OFF
[H7] Contact Output 7 Events	Enabled
[H8] Contact Output 8 ID	Cont Op 8
[H8] Contact Output 8 Operate	TRIPBUS 2 OP
[H8] Contact Output 8 Seal-In	OFF
[H8] Contact Output 8 Events	Enabled

VIRTUAL OUTPUTS

Virtual Output 1 ID	81U_op
Virtual Output 1 Events	Enabled
Virtual Output 2 ID	81O_op
Virtual Output 2 Events	Enabled
Virtual Output 3 ID	50_51P_op
Virtual Output 3 Events	Enabled
Virtual Output 4 ID	27P_op
Virtual Output 4 Events	Enabled
Virtual Output 5 ID	81U_pu
Virtual Output 5 Events	Enabled
Virtual Output 6 ID	81O_pu
Virtual Output 6 Events	Enabled
Virtual Output 7 ID	50_51P_pu
Virtual Output 7 Events	Enabled
Virtual Output 8 ID	27P_pu
Virtual Output 8 Events	Enabled
Virtual Output 9 ID	87G_pu
Virtual Output 9 Events	Enabled
Virtual Output 10 ID	Int_Cerrado
Virtual Output 10 Events	Enabled
Virtual Output 11 ID	Int_Abierto
Virtual Output 11 Events	Enabled
Virtual Output 12 ID	Bloqueo32R
Virtual Output 12 Events	Enabled

REMOTE DEVICES

Remote Device 1 ID	Remote Device 1
Remote Device 1 ETYPE APPID	0
Remote Device 1 DATASET	Fixed
Remote Device 2 ID	Remote Device 2
Remote Device 2 ETYPE APPID	0
Remote Device 2 DATASET	Fixed
Remote Device 3 ID	Remote Device 3
Remote Device 3 ETYPE APPID	0
Remote Device 3 DATASET	Fixed
Remote Device 4 ID	Remote Device 4
Remote Device 4 ETYPE APPID	0
Remote Device 4 DATASET	Fixed
Remote Device 5 ID	Remote Device 5
Remote Device 5 ETYPE APPID	0
Remote Device 5 DATASET	Fixed
Remote Device 6 ID	Remote Device 6
Remote Device 6 ETYPE APPID	0
Remote Device 6 DATASET	Fixed
Remote Device 7 ID	Remote Device 7
Remote Device 7 ETYPE APPID	0
Remote Device 7 DATASET	Fixed
Remote Device 8 ID	Remote Device 8
Remote Device 8 ETYPE APPID	0
Remote Device 8 DATASET	Fixed
Remote Device 9 ID	Remote Device 9
Remote Device 9 ETYPE APPID	0
Remote Device 9 DATASET	Fixed
Remote Device 10 ID	Remote Device 10
Remote Device 10 ETYPE APPID	0
Remote Device 10 DATASET	Fixed
Remote Device 11 ID	Remote Device 11

UNIDAD N1 - C. FLORIDA 2.URS

C:\USERS\CDIAZ\DESKTOP\PROTECCIONES\PROTECCIONES\BACK-UP RELES DE PROTECCION\

DEVICE DEFINITION

FILES

ORDER CODE: G30-N03-HKH-F8L-H6C-M8N-P6D-UXX-WXX

VERSION: 6.0X

UR SERIAL NUMBER: AAKC12000239

SETTINGS SEND TO RELAY: TUESDAY, FEBRUARY 23, 2016 10:28:03

DESCRIPTION: (NONE)

TEXT COLOR

REMOTE DEVICES (continued from last page)

Remote Device 11 ETYPE APPID	0
Remote Device 11 DATASET	Fixed
Remote Device 12 ID	Remote Device 12
Remote Device 12 ETYPE APPID	0
Remote Device 12 DATASET	Fixed
Remote Device 13 ID	Remote Device 13
Remote Device 13 ETYPE APPID	0
Remote Device 13 DATASET	Fixed
Remote Device 14 ID	Remote Device 14
Remote Device 14 ETYPE APPID	0
Remote Device 14 DATASET	Fixed
Remote Device 15 ID	Remote Device 15
Remote Device 15 ETYPE APPID	0
Remote Device 15 DATASET	Fixed
Remote Device 16 ID	Remote Device 16
Remote Device 16 ETYPE APPID	0
Remote Device 16 DATASET	Fixed

IEC 61850 GOOSE ANALOGS INPUTS

IEC61850 GOOSE Analog Input 1 Default Value	1000.000
IEC61850 GOOSE Analog Input 1 Mode	Default Value
IEC61850 GOOSE Analog Input 1 Units	
IEC61850 GOOSE Analog Input 1 PU Base	1.000
IEC61850 GOOSE Analog Input 2 Default Value	1000.000
IEC61850 GOOSE Analog Input 2 Mode	Default Value
IEC61850 GOOSE Analog Input 2 Units	
IEC61850 GOOSE Analog Input 2 PU Base	1.000
IEC61850 GOOSE Analog Input 3 Default Value	1000.000
IEC61850 GOOSE Analog Input 3 Mode	Default Value
IEC61850 GOOSE Analog Input 3 Units	
IEC61850 GOOSE Analog Input 3 PU Base	1.000
IEC61850 GOOSE Analog Input 4 Default Value	1000.000
IEC61850 GOOSE Analog Input 4 Mode	Default Value
IEC61850 GOOSE Analog Input 4 Units	
IEC61850 GOOSE Analog Input 4 PU Base	1.000
IEC61850 GOOSE Analog Input 5 Default Value	1000.000
IEC61850 GOOSE Analog Input 5 Mode	Default Value
IEC61850 GOOSE Analog Input 5 Units	
IEC61850 GOOSE Analog Input 5 PU Base	1.000
IEC61850 GOOSE Analog Input 6 Default Value	1000.000
IEC61850 GOOSE Analog Input 6 Mode	Default Value
IEC61850 GOOSE Analog Input 6 Units	
IEC61850 GOOSE Analog Input 6 PU Base	1.000
IEC61850 GOOSE Analog Input 7 Default Value	1000.000
IEC61850 GOOSE Analog Input 7 Mode	Default Value
IEC61850 GOOSE Analog Input 7 Units	
IEC61850 GOOSE Analog Input 7 PU Base	1.000
IEC61850 GOOSE Analog Input 8 Default Value	1000.000
IEC61850 GOOSE Analog Input 8 Mode	Default Value
IEC61850 GOOSE Analog Input 8 Units	
IEC61850 GOOSE Analog Input 8 PU Base	1.000
IEC61850 GOOSE Analog Input 9 Default Value	1000.000
IEC61850 GOOSE Analog Input 9 Mode	Default Value
IEC61850 GOOSE Analog Input 9 Units	
IEC61850 GOOSE Analog Input 9 PU Base	1.000
IEC61850 GOOSE Analog Input 10 Default Value	1000.000
IEC61850 GOOSE Analog Input 10 Mode	Default Value
IEC61850 GOOSE Analog Input 10 Units	
IEC61850 GOOSE Analog Input 10 PU Base	1.000
IEC61850 GOOSE Analog Input 11 Default Value	1000.000
IEC61850 GOOSE Analog Input 11 Mode	Default Value
IEC61850 GOOSE Analog Input 11 Units	
IEC61850 GOOSE Analog Input 11 PU Base	1.000
IEC61850 GOOSE Analog Input 12 Default Value	1000.000
IEC61850 GOOSE Analog Input 12 Mode	Default Value
IEC61850 GOOSE Analog Input 12 Units	
IEC61850 GOOSE Analog Input 12 PU Base	1.000
IEC61850 GOOSE Analog Input 13 Default Value	1000.000
IEC61850 GOOSE Analog Input 13 Mode	Default Value
IEC61850 GOOSE Analog Input 13 Units	
IEC61850 GOOSE Analog Input 13 PU Base	1.000

UNIDAD N1 - C. FLORIDA 2.URS

C:\USERS\CDIAZ\DESKTOP\PROTECCIONES\PROTECCIONES\BACK-UP RELES DE PROTECCION\

DEVICE DEFINITION

FILES

ORDER CODE: G30-N03-HKH-F8L-H6C-M8N-P6D-UXX-WXX

VERSION: 6.0X

UR SERIAL NUMBER: AAKC12000239

SETTINGS SEND TO RELAY: TUESDAY, FEBRUARY 23, 2016 10:28:03

DESCRIPTION: (NONE)

TEXT COLOR

IEC 61850 GOOSE ANALOGS INPUTS (continued from last page)

IEC61850 GOOSE Analog Input 14 Default Value	1000.000
IEC61850 GOOSE Analog Input 14 Mode	Default Value
IEC61850 GOOSE Analog Input 14 Units	
IEC61850 GOOSE Analog Input 14 PU Base	1.000
IEC61850 GOOSE Analog Input 15 Default Value	1000.000
IEC61850 GOOSE Analog Input 15 Mode	Default Value
IEC61850 GOOSE Analog Input 15 Units	
IEC61850 GOOSE Analog Input 15 PU Base	1.000
IEC61850 GOOSE Analog Input 16 Default Value	1000.000
IEC61850 GOOSE Analog Input 16 Mode	Default Value
IEC61850 GOOSE Analog Input 16 Units	
IEC61850 GOOSE Analog Input 16 PU Base	1.000
IEC61850 GOOSE Analog Input 17 Default Value	1000.000
IEC61850 GOOSE Analog Input 17 Mode	Default Value
IEC61850 GOOSE Analog Input 17 Units	
IEC61850 GOOSE Analog Input 17 PU Base	1.000
IEC61850 GOOSE Analog Input 18 Default Value	1000.000
IEC61850 GOOSE Analog Input 18 Mode	Default Value
IEC61850 GOOSE Analog Input 18 Units	
IEC61850 GOOSE Analog Input 18 PU Base	1.000
IEC61850 GOOSE Analog Input 19 Default Value	1000.000
IEC61850 GOOSE Analog Input 19 Mode	Default Value
IEC61850 GOOSE Analog Input 19 Units	
IEC61850 GOOSE Analog Input 19 PU Base	1.000
IEC61850 GOOSE Analog Input 20 Default Value	1000.000
IEC61850 GOOSE Analog Input 20 Mode	Default Value
IEC61850 GOOSE Analog Input 20 Units	
IEC61850 GOOSE Analog Input 20 PU Base	1.000
IEC61850 GOOSE Analog Input 21 Default Value	1000.000
IEC61850 GOOSE Analog Input 21 Mode	Default Value
IEC61850 GOOSE Analog Input 21 Units	
IEC61850 GOOSE Analog Input 21 PU Base	1.000
IEC61850 GOOSE Analog Input 22 Default Value	1000.000
IEC61850 GOOSE Analog Input 22 Mode	Default Value
IEC61850 GOOSE Analog Input 22 Units	
IEC61850 GOOSE Analog Input 22 PU Base	1.000
IEC61850 GOOSE Analog Input 23 Default Value	1000.000
IEC61850 GOOSE Analog Input 23 Mode	Default Value
IEC61850 GOOSE Analog Input 23 Units	
IEC61850 GOOSE Analog Input 23 PU Base	1.000
IEC61850 GOOSE Analog Input 24 Default Value	1000.000
IEC61850 GOOSE Analog Input 24 Mode	Default Value
IEC61850 GOOSE Analog Input 24 Units	
IEC61850 GOOSE Analog Input 24 PU Base	1.000
IEC61850 GOOSE Analog Input 25 Default Value	1000.000
IEC61850 GOOSE Analog Input 25 Mode	Default Value
IEC61850 GOOSE Analog Input 25 Units	
IEC61850 GOOSE Analog Input 25 PU Base	1.000
IEC61850 GOOSE Analog Input 26 Default Value	1000.000
IEC61850 GOOSE Analog Input 26 Mode	Default Value
IEC61850 GOOSE Analog Input 26 Units	
IEC61850 GOOSE Analog Input 26 PU Base	1.000
IEC61850 GOOSE Analog Input 27 Default Value	1000.000
IEC61850 GOOSE Analog Input 27 Mode	Default Value
IEC61850 GOOSE Analog Input 27 Units	
IEC61850 GOOSE Analog Input 27 PU Base	1.000
IEC61850 GOOSE Analog Input 28 Default Value	1000.000
IEC61850 GOOSE Analog Input 28 Mode	Default Value
IEC61850 GOOSE Analog Input 28 Units	
IEC61850 GOOSE Analog Input 28 PU Base	1.000
IEC61850 GOOSE Analog Input 29 Default Value	1000.000
IEC61850 GOOSE Analog Input 29 Mode	Default Value
IEC61850 GOOSE Analog Input 29 Units	
IEC61850 GOOSE Analog Input 29 PU Base	1.000
IEC61850 GOOSE Analog Input 30 Default Value	1000.000
IEC61850 GOOSE Analog Input 30 Mode	Default Value
IEC61850 GOOSE Analog Input 30 Units	
IEC61850 GOOSE Analog Input 30 PU Base	1.000
IEC61850 GOOSE Analog Input 31 Default Value	1000.000
IEC61850 GOOSE Analog Input 31 Mode	Default Value
IEC61850 GOOSE Analog Input 31 Units	

UNIDAD N1 - C. FLORIDA 2.URS

C:\USERS\CDIAZ\DESKTOP\PROTECCIONES\PROTECCIONES\BACK-UP RELES DE PROTECCION\

DEVICE DEFINITION

FILES

ORDER CODE: G30-N03-HKH-F8L-H6C-M8N-P6D-UXX-WXX

VERSION: 6.0X

UR SERIAL NUMBER: AAKC12000239

SETTINGS SEND TO RELAY: TUESDAY, FEBRUARY 23, 2016 10:28:03

DESCRIPTION: (NONE)

TEXT COLOR

IEC 61850 GOOSE ANALOGS INPUTS (continued from last page)

IEC61850 GOOSE Analog Input 31 PU Base	1.000
IEC61850 GOOSE Analog Input 32 Default Value	1000.000
IEC61850 GOOSE Analog Input 32 Mode	Default Value
IEC61850 GOOSE Analog Input 32 Units	
IEC61850 GOOSE Analog Input 32 PU Base	1.000

IEC 61850 GOOSE UINTEGERS INPUTS

IEC61850 GOOSE UInteger Input 1 Default Value	1000
IEC61850 GOOSE UInteger Input 1 Mode	Default Value
IEC61850 GOOSE UInteger Input 2 Default Value	1000
IEC61850 GOOSE UInteger Input 2 Mode	Default Value
IEC61850 GOOSE UInteger Input 3 Default Value	1000
IEC61850 GOOSE UInteger Input 3 Mode	Default Value
IEC61850 GOOSE UInteger Input 4 Default Value	1000
IEC61850 GOOSE UInteger Input 4 Mode	Default Value
IEC61850 GOOSE UInteger Input 5 Default Value	1000
IEC61850 GOOSE UInteger Input 5 Mode	Default Value
IEC61850 GOOSE UInteger Input 6 Default Value	1000
IEC61850 GOOSE UInteger Input 6 Mode	Default Value
IEC61850 GOOSE UInteger Input 7 Default Value	1000
IEC61850 GOOSE UInteger Input 7 Mode	Default Value
IEC61850 GOOSE UInteger Input 8 Default Value	1000
IEC61850 GOOSE UInteger Input 8 Mode	Default Value
IEC61850 GOOSE UInteger Input 9 Default Value	1000
IEC61850 GOOSE UInteger Input 9 Mode	Default Value
IEC61850 GOOSE UInteger Input 10 Default Value	1000
IEC61850 GOOSE UInteger Input 10 Mode	Default Value
IEC61850 GOOSE UInteger Input 11 Default Value	1000
IEC61850 GOOSE UInteger Input 11 Mode	Default Value
IEC61850 GOOSE UInteger Input 12 Default Value	1000
IEC61850 GOOSE UInteger Input 12 Mode	Default Value
IEC61850 GOOSE UInteger Input 13 Default Value	1000
IEC61850 GOOSE UInteger Input 13 Mode	Default Value
IEC61850 GOOSE UInteger Input 14 Default Value	1000
IEC61850 GOOSE UInteger Input 14 Mode	Default Value
IEC61850 GOOSE UInteger Input 15 Default Value	1000
IEC61850 GOOSE UInteger Input 15 Mode	Default Value
IEC61850 GOOSE UInteger Input 16 Default Value	1000
IEC61850 GOOSE UInteger Input 16 Mode	Default Value

UNIDAD N1 - C. FLORIDA 3.URS

C:\USERS\CDIAZ\DESKTOP\PROTECCIONES\PROTECCIONES\BACK-UP RELES DE PROTECCION\

DEVICE DEFINITION

FILES

ORDER CODE: G30-N03-HKH-F8L-H6C-M8N-P6D-UXX-WXX
 VERSION: 5.7X
 UR SERIAL NUMBER: AAKC09000130
 SETTINGS SEND TO RELAY: TUESDAY, NOVEMBER 03, 2015 15:14:01
 DESCRIPTION: (NONE)
 TEXT COLOR

RELAY INFORMATION

Main Firmware:	570
Boot Firmware:	301
Relay Serial Number:	AAKC09000130
CPU Serial Number:	A9NC09002105
F8L Module Serial Number	A8LC09007447
H6C Module Serial Number	A6CC09002807
M8N Module Serial Number	A8NC09002405
P6D Module Serial Number	A6DC09003360
UXX Module Serial Number	
Settings Send to Relay	Tuesday, November 03, 2015 15:14:01

PRODUCT SETUP

SECURITY

Command Password	0
Setting Password	0
Command Password Access Timeout	5 min
Setting Password Access Timeout	30 min
Invalid Password Attempts	3
Password Lockout Duration	5 min
Password Access Events	Disabled
Local Setting Authorized	ON
Remote Setting Authorized	ON
Access Authorized Timeout	30 min

DISPLAY PROPERTIES

Flash Message Time	1.0 s
Default Message Timeout	300 s
Default Message Intensity (VFD Only)	25 %
Screen Saver Feature (LCD Only)	Disabled
Screen Saver Wait Time (LCD Only)	30 min
Current Cutoff Level	0.020 pu
Voltage Cutoff Level	1.0 V

COMMUNICATIONS

SERIAL PORTS

RS485 Com2 Baud Rate	19200
RS485 Com2 Parity	None
RS485 Com2 Response Min Time	0 ms

NETWORK

IP Address	192.168. 31. 63
IP Subnet Mask	255.255.255. 0
Gateway IP Address	192.168. 31. 1
OSI Network Address (NSAP)	00 00

MODBUS PROTOCOL

Modbus Slave Address	254
Modbus TCP Port Number	502

DNP PROTOCOL

DNP Channel 1 Port	NETWORK - TCP
DNP Channel 2 Port	NONE
DNP Address	26
DNP Client Address 1	192.168. 21. 99
DNP Client Address 2	0. 0. 0. 0
DNP Client Address 3	0. 0. 0. 0
DNP Client Address 4	0. 0. 0. 0
DNP Client Address 5	0. 0. 0. 0
DNP TCP/UDP Port Number	20000
DNP Unsol Resp Function	Enabled
DNP Unsol Resp Timeout	5 s
DNP Unsol Resp Max Retries	100
DNP Unsol Resp Dest Addr	1
DNP Current Scale Factor	1
DNP Voltage Scale Factor	1
DNP Power Scale Factor	1
DNP Energy Scale Factor	1
DNP Power Factor Scale Factor	1
DNP Other Scale Factor	1
DNP Current Default Deadband	30000
DNP Voltage Default Deadband	30000

UNIDAD N1 - C. FLORIDA 3.URS

C:\USERS\CDIAZ\DESKTOP\PROTECCIONES\PROTECCIONES\BACK-UP RELES DE PROTECCION\

DEVICE DEFINITION

FILES

ORDER CODE: G30-N03-HKH-F8L-H6C-M8N-P6D-UXX-WXX

VERSION: 5.7X

UR SERIAL NUMBER: AAKC09000130

SETTINGS SEND TO RELAY: TUESDAY, NOVEMBER 03, 2015 15:14:01

DESCRIPTION: (NONE)

TEXT COLOR

DNP PROTOCOL (continued from last page)

DNP Power Default Deadband	30000
DNP Energy Default Deadband	30000
DNP Power Factor Default Deadband	30000
DNP Other Default Deadband	30000
DNP Time Sync IIN Period	1440 min
DNP Message Fragment Size	240
DNP Number of Paired Controls	0
DNP TCP Connection Timeout	120 s
DNP Object 1 Default Variation	2
DNP Object 2 Default Variation	2
DNP Object 30 Default Variation	1
DNP Object 20 Default Variation	1
DNP Object 21 Default Variation	1
DNP Object 22 Default Variation	1
DNP Object 23 Default Variation	1
DNP Object 32 Default Variation	1

DNP - IEC104 POINTS LISTS

DNP Binary Input Point 2	TRIP On (VO3)
DNP Binary Input Point 3	UNDERFREQ 1 OP
DNP Binary Input Point 4	OVERFREQ 1 OP
DNP Binary Input Point 5	XFMR PCNT DIFF OP
DNP Binary Input Point 6	PHASE TOC1 OP
DNP Binary Input Point 7	GROUND TOC1 OP
DNP Binary Input Point 8	PHASE UV1 OP
DNP Binary Input Point 9	PHASE UV2 OP
DNP Binary Input Point 10	50BF On (VO6)
DNP Binary Input Point 11	PHASE OV1 OP
DNP Binary Input Point 12	AUX OV 1 OP
DNP Binary Input Point 13	VOLTS PER HERTZ 1 OP
DNP Binary Input Point 14	LOSS EXCIT OP
DNP Binary Input Point 15	ACCDNT ENRG OP
DNP Binary Input Point 16	DIR POWER 1 OP
DNP Binary Input Point 17	EXT TRIP1 On (VO1)
DNP Binary Input Point 18	EXT TRIP2 On (VO2)
DNP Analog Input Point 0	SRC2 Ia Mag
DNP Analog Input Point 1	SRC2 Ia Angle
DNP Analog Input Point 2	SRC2 Ib Mag
DNP Analog Input Point 3	SRC2 Ib Angle
DNP Analog Input Point 4	SRC2 Ic Mag
DNP Analog Input Point 5	SRC2 Ic Angle
DNP Analog Input Point 6	SRC2 In Mag
DNP Analog Input Point 7	SRC2 In Angle
DNP Analog Input Point 8	SRC1 Ig Mag
DNP Analog Input Point 9	SRC1 Ig Angle
DNP Analog Input Point 10	SRC2 Vab Mag
DNP Analog Input Point 11	SRC2 Vab Angle
DNP Analog Input Point 12	SRC2 Vbc Mag
DNP Analog Input Point 13	SRC2 Vbc Angle
DNP Analog Input Point 14	SRC2 Vca Mag
DNP Analog Input Point 15	SRC2 Vca Angle
DNP Analog Input Point 16	SRC2 P
DNP Analog Input Point 17	SRC2 Q
DNP Analog Input Point 18	SRC2 S
DNP Analog Input Point 19	SRC2 PF
DNP Analog Input Point 20	SRC1 PF
DNP Analog Input Point 21	SRC2 Frequency
DNP Analog Input Point 22	SRC2 Pos Watthour
DNP Analog Input Point 23	SRC2 Neg Watthour
DNP Analog Input Point 24	SRC2 Pos varh
DNP Analog Input Point 25	SRC2 Neg varh
DNP Analog Input Point 26	SRC2 I_0 Mag
DNP Analog Input Point 27	SRC2 I_0 Angle
DNP Analog Input Point 28	SRC2 I_1 Mag
DNP Analog Input Point 29	SRC2 I_1 Angle
DNP Analog Input Point 30	SRC2 I_2 Mag
DNP Analog Input Point 31	SRC2 I_2 Angle
DNP Analog Input Point 32	SRC1 Vx Mag
DNP Analog Input Point 33	SRC2 Vx Angle
DNP Analog Input Point 34	SRC2 V_0 Mag
DNP Analog Input Point 35	SRC2 V_0 Angle

UNIDAD N1 - C. FLORIDA 3.URS

C:\USERS\CDIAZ\DESKTOP\PROTECCIONES\PROTECCIONES\BACK-UP RELES DE PROTECCION\

DEVICE DEFINITION

FILES

ORDER CODE: G30-N03-HKH-F8L-H6C-M8N-P6D-UXX-WXX
 VERSION: 5.7X
 UR SERIAL NUMBER: AAKC09000130
 SETTINGS SEND TO RELAY: TUESDAY, NOVEMBER 03, 2015 15:14:01
 DESCRIPTION: (NONE)
 TEXT COLOR

DNP - IEC104 POINTS LISTS (continued from last page)

DNP Analog Input Point 36	SRC2	V_1 Mag
DNP Analog Input Point 37	SRC2	V_1 Angle
DNP Analog Input Point 38	SRC2	V_2 Mag
DNP Analog Input Point 39	SRC2	V_2 Angle
DNP Analog Input Point 40		Volts Per Hertz 1
DNP Analog Input Point 41		Volts Per Hertz 2
DNP Analog Input Point 42		Communications Group
DNP Analog Input Point 43		Tracking Frequency
DNP Analog Input Point 44		Active Setting Group

IEC 61850

GSSE / GOOSE CONFIGURATION

TRANSMISSION

GENERAL

Default GSSE/GOOSE Update Time	60 s
--------------------------------	------

GSSE

Function	Enabled
ID	GSSEOut
Destination MAC	00 00 00 00 00 00

TX CONFIGURABLE GOOSE

GOOSEOut 1 Function	Enabled
GOOSEOut 1 ID	GOOSEOut_1
GOOSEOut 1 Destination MAC	00 00 00 00 00 00
GOOSEOut 1 VLAN Priority	4
GOOSEOut 1 VLAN ID	0
GOOSEOut 1 ETYPE APPID	0
GOOSEOut 1 ConfRev	1
GOOSEOut 1 Retransmission Curve	Relaxed
GOOSEOut 2 Function	Enabled
GOOSEOut 2 ID	GOOSEOut_2
GOOSEOut 2 Destination MAC	00 00 00 00 00 00
GOOSEOut 2 VLAN Priority	4
GOOSEOut 2 VLAN ID	0
GOOSEOut 2 ETYPE APPID	0
GOOSEOut 2 ConfRev	1
GOOSEOut 2 Retransmission Curve	Relaxed
GOOSEOut 3 Function	Enabled
GOOSEOut 3 ID	GOOSEOut_3
GOOSEOut 3 Destination MAC	00 00 00 00 00 00
GOOSEOut 3 VLAN Priority	4
GOOSEOut 3 VLAN ID	0
GOOSEOut 3 ETYPE APPID	0
GOOSEOut 3 ConfRev	1
GOOSEOut 3 Retransmission Curve	Relaxed
GOOSEOut 4 Function	Enabled
GOOSEOut 4 ID	GOOSEOut_4
GOOSEOut 4 Destination MAC	00 00 00 00 00 00
GOOSEOut 4 VLAN Priority	4
GOOSEOut 4 VLAN ID	0
GOOSEOut 4 ETYPE APPID	0
GOOSEOut 4 ConfRev	1
GOOSEOut 4 Retransmission Curve	Relaxed
GOOSEOut 5 Function	Enabled
GOOSEOut 5 ID	GOOSEOut_5
GOOSEOut 5 Destination MAC	00 00 00 00 00 00
GOOSEOut 5 VLAN Priority	4
GOOSEOut 5 VLAN ID	0
GOOSEOut 5 ETYPE APPID	0
GOOSEOut 5 ConfRev	1
GOOSEOut 5 Retransmission Curve	Relaxed
GOOSEOut 6 Function	Enabled
GOOSEOut 6 ID	GOOSEOut_6
GOOSEOut 6 Destination MAC	00 00 00 00 00 00
GOOSEOut 6 VLAN Priority	4
GOOSEOut 6 VLAN ID	0
GOOSEOut 6 ETYPE APPID	0
GOOSEOut 6 ConfRev	1
GOOSEOut 6 Retransmission Curve	Relaxed
GOOSEOut 7 Function	Enabled

UNIDAD N1 - C. FLORIDA 3.URS

C:\USERS\CDIAZ\DESKTOP\PROTECCIONES\PROTECCIONES\BACK-UP RELES DE PROTECCION\

DEVICE DEFINITION

FILES

ORDER CODE: G30-N03-HKH-F8L-H6C-M8N-P6D-UXX-WXX

VERSION: 5.7X

UR SERIAL NUMBER: AAKC09000130

SETTINGS SEND TO RELAY: TUESDAY, NOVEMBER 03, 2015 15:14:01

DESCRIPTION: (NONE)

TEXT COLOR

TX CONFIGURABLE GOOSE (continued from last page)

GOOSEOut 7 ID	GOOSEOut_7
GOOSEOut 7 Destination MAC	00 00 00 00 00 00
GOOSEOut 7 VLAN Priority	4
GOOSEOut 7 VLAN ID	0
GOOSEOut 7 ETYPE APPID	0
GOOSEOut 7 ConfRev	1
GOOSEOut 7 Retransmission Curve	Relaxed
GOOSEOut 8 Function	Enabled
GOOSEOut 8 ID	GOOSEOut_8
GOOSEOut 8 Destination MAC	00 00 00 00 00 00
GOOSEOut 8 VLAN Priority	4
GOOSEOut 8 VLAN ID	0
GOOSEOut 8 ETYPE APPID	0
GOOSEOut 8 ConfRev	1
GOOSEOut 8 Retransmission Curve	Relaxed

SERVER CONFIGURATION

IEDName	IEDName
Logical Device Instance	LDInst
MMS TCP Port Number	102
LPHD DC PhyNam location	Location

MMXU DEADBANDS

MMXU1: TotW Deadband	10.000 %
MMXU1: TotVAr Deadband	10.000 %
MMXU1: TotVA Deadband	10.000 %
MMXU1: TotPF Deadband	10.000 %
MMXU1: Hz Deadband	10.000 %
MMXU1: PPV phsAB Deadband	10.000 %
MMXU1: PPV phsBC Deadband	10.000 %
MMXU1: PPV phsCA Deadband	10.000 %
MMXU1: PhV phsA Deadband	10.000 %
MMXU1: PhV phsB Deadband	10.000 %
MMXU1: PhV phsC Deadband	10.000 %
MMXU1: A phsA Deadband	10.000 %
MMXU1: A phsB Deadband	10.000 %
MMXU1: A phsC Deadband	10.000 %
MMXU1: A neut Deadband	10.000 %
MMXU1: W phsA Deadband	10.000 %
MMXU1: W phsB Deadband	10.000 %
MMXU1: W phsC Deadband	10.000 %
MMXU1: VAr phsA Deadband	10.000 %
MMXU1: VAr phsB Deadband	10.000 %
MMXU1: VAr phsC Deadband	10.000 %
MMXU1: VA phsA Deadband	10.000 %
MMXU1: VA phsB Deadband	10.000 %
MMXU1: VA phsC Deadband	10.000 %
MMXU1: PF phsA Deadband	10.000 %
MMXU1: PF phsB Deadband	10.000 %
MMXU1: PF phsC Deadband	10.000 %
MMXU2: TotW Deadband	10.000 %
MMXU2: TotVAr Deadband	10.000 %
MMXU2: TotVA Deadband	10.000 %
MMXU2: TotPF Deadband	10.000 %
MMXU2: Hz Deadband	10.000 %
MMXU2: PPV phsAB Deadband	10.000 %
MMXU2: PPV phsBC Deadband	10.000 %
MMXU2: PPV phsCA Deadband	10.000 %
MMXU2: PhV phsA Deadband	10.000 %
MMXU2: PhV phsB Deadband	10.000 %
MMXU2: PhV phsC Deadband	10.000 %
MMXU2: A phsA Deadband	10.000 %
MMXU2: A phsB Deadband	10.000 %
MMXU2: A phsC Deadband	10.000 %
MMXU2: A neut Deadband	10.000 %
MMXU2: W phsA Deadband	10.000 %
MMXU2: W phsB Deadband	10.000 %
MMXU2: W phsC Deadband	10.000 %
MMXU2: VAr phsA Deadband	10.000 %
MMXU2: VAr phsB Deadband	10.000 %
MMXU2: VAr phsC Deadband	10.000 %

UNIDAD N1 - C. FLORIDA 3.URS

C:\USERS\CDIAZ\DESKTOP\PROTECCIONES\PROTECCIONES\BACK-UP RELES DE PROTECCION\

DEVICE DEFINITION

FILES

ORDER CODE: G30-N03-HKH-F8L-H6C-M8N-P6D-UXX-WXX

VERSION: 5.7X

UR SERIAL NUMBER: AAKC09000130

SETTINGS SEND TO RELAY: TUESDAY, NOVEMBER 03, 2015 15:14:01

DESCRIPTION: (NONE)

TEXT COLOR

MMXU DEADBANDS (continued from last page)

MMXU2: VA phsA Deadband	10.000 %
MMXU2: VA phsB Deadband	10.000 %
MMXU2: VA phsC Deadband	10.000 %
MMXU2: PF phsA Deadband	10.000 %
MMXU2: PF phsB Deadband	10.000 %
MMXU2: PF phsC Deadband	10.000 %
MMXU3: TotW Deadband	10.000 %
MMXU3: TotVAr Deadband	10.000 %
MMXU3: TotVA Deadband	10.000 %
MMXU3: TotPF Deadband	10.000 %
MMXU3: Hz Deadband	10.000 %
MMXU3: PPV phsAB Deadband	10.000 %
MMXU3: PPV phsBC Deadband	10.000 %
MMXU3: PPV phsCA Deadband	10.000 %
MMXU3: PhV phsA Deadband	10.000 %
MMXU3: PhV phsB Deadband	10.000 %
MMXU3: PhV phsC Deadband	10.000 %
MMXU3: A phsA Deadband	10.000 %
MMXU3: A phsB Deadband	10.000 %
MMXU3: A phsC Deadband	10.000 %
MMXU3: A neut Deadband	10.000 %
MMXU3: W phsA Deadband	10.000 %
MMXU3: W phsB Deadband	10.000 %
MMXU3: W phsC Deadband	10.000 %
MMXU3: VAr phsA Deadband	10.000 %
MMXU3: VAr phsB Deadband	10.000 %
MMXU3: VAr phsC Deadband	10.000 %
MMXU3: VA phsA Deadband	10.000 %
MMXU3: VA phsB Deadband	10.000 %
MMXU3: VA phsC Deadband	10.000 %
MMXU3: PF phsA Deadband	10.000 %
MMXU3: PF phsB Deadband	10.000 %
MMXU3: PF phsC Deadband	10.000 %
MMXU4: TotW Deadband	10.000 %
MMXU4: TotVAr Deadband	10.000 %
MMXU4: TotVA Deadband	10.000 %
MMXU4: TotPF Deadband	10.000 %
MMXU4: Hz Deadband	10.000 %
MMXU4: PPV phsAB Deadband	10.000 %
MMXU4: PPV phsBC Deadband	10.000 %
MMXU4: PPV phsCA Deadband	10.000 %
MMXU4: PhV phsA Deadband	10.000 %
MMXU4: PhV phsB Deadband	10.000 %
MMXU4: PhV phsC Deadband	10.000 %
MMXU4: A phsA Deadband	10.000 %
MMXU4: A phsB Deadband	10.000 %
MMXU4: A phsC Deadband	10.000 %
MMXU4: A neut Deadband	10.000 %
MMXU4: W phsA Deadband	10.000 %
MMXU4: W phsB Deadband	10.000 %
MMXU4: W phsC Deadband	10.000 %
MMXU4: VAr phsA Deadband	10.000 %
MMXU4: VAr phsB Deadband	10.000 %
MMXU4: VAr phsC Deadband	10.000 %
MMXU4: VA phsA Deadband	10.000 %
MMXU4: VA phsB Deadband	10.000 %
MMXU4: VA phsC Deadband	10.000 %
MMXU4: PF phsA Deadband	10.000 %
MMXU4: PF phsB Deadband	10.000 %
MMXU4: PF phsC Deadband	10.000 %

GGIO1 STATUS CONFIGURATION

Number of Status Points 8

GGIO2 CONTROL CONFIGURATION

SPCSO 1 ctlModel	1
SPCSO 2 ctlModel	1
SPCSO 3 ctlModel	1
SPCSO 4 ctlModel	1
SPCSO 5 ctlModel	1
SPCSO 6 ctlModel	1

UNIDAD N1 - C. FLORIDA 3.URS

C:\USERS\CDIAZ\DESKTOP\PROTECCIONES\PROTECCIONES\BACK-UP RELES DE PROTECCION\

DEVICE DEFINITION

FILES

ORDER CODE: G30-N03-HKH-F8L-H6C-M8N-P6D-UXX-WXX

VERSION: 5.7X

UR SERIAL NUMBER: AAKC09000130

SETTINGS SEND TO RELAY: TUESDAY, NOVEMBER 03, 2015 15:14:01

DESCRIPTION: (NONE)

TEXT COLOR

GGIO2 CONTROL CONFIGURATION (continued from last page)

SPCSO 7 ctlModel	1
SPCSO 8 ctlModel	1
SPCSO 9 ctlModel	1
SPCSO 10 ctlModel	1
SPCSO 11 ctlModel	1
SPCSO 12 ctlModel	1
SPCSO 13 ctlModel	1
SPCSO 14 ctlModel	1
SPCSO 15 ctlModel	1
SPCSO 16 ctlModel	1
SPCSO 17 ctlModel	1
SPCSO 18 ctlModel	1
SPCSO 19 ctlModel	1
SPCSO 20 ctlModel	1
SPCSO 21 ctlModel	1
SPCSO 22 ctlModel	1
SPCSO 23 ctlModel	1
SPCSO 24 ctlModel	1
SPCSO 25 ctlModel	1
SPCSO 26 ctlModel	1
SPCSO 27 ctlModel	1
SPCSO 28 ctlModel	1
SPCSO 29 ctlModel	1
SPCSO 30 ctlModel	1
SPCSO 31 ctlModel	1
SPCSO 32 ctlModel	1
SPCSO 33 ctlModel	1
SPCSO 34 ctlModel	1
SPCSO 35 ctlModel	1
SPCSO 36 ctlModel	1
SPCSO 37 ctlModel	1
SPCSO 38 ctlModel	1
SPCSO 39 ctlModel	1
SPCSO 40 ctlModel	1
SPCSO 41 ctlModel	1
SPCSO 42 ctlModel	1
SPCSO 43 ctlModel	1
SPCSO 44 ctlModel	1
SPCSO 45 ctlModel	1
SPCSO 46 ctlModel	1
SPCSO 47 ctlModel	1
SPCSO 48 ctlModel	1
SPCSO 49 ctlModel	1
SPCSO 50 ctlModel	1
SPCSO 51 ctlModel	1
SPCSO 52 ctlModel	1
SPCSO 53 ctlModel	1
SPCSO 54 ctlModel	1
SPCSO 55 ctlModel	1
SPCSO 56 ctlModel	1
SPCSO 57 ctlModel	1
SPCSO 58 ctlModel	1
SPCSO 59 ctlModel	1
SPCSO 60 ctlModel	1
SPCSO 61 ctlModel	1
SPCSO 62 ctlModel	1
SPCSO 63 ctlModel	1
SPCSO 64 ctlModel	1

GGIO4 ANALOG CONFIGURATION

IEC61850 GGIO4 Analogs	4
IEC61850 GGIO4 Analog 1 Value	OFF
IEC61850 GGIO4 Analog 1 db	100.000 %
IEC61850 GGIO4 Analog 1 min	0.000
IEC61850 GGIO4 Analog 1 max	1000000.000
IEC61850 GGIO4 Analog 2 Value	OFF
IEC61850 GGIO4 Analog 2 db	100.000 %
IEC61850 GGIO4 Analog 2 min	0.000
IEC61850 GGIO4 Analog 2 max	1000000.000
IEC61850 GGIO4 Analog 3 Value	OFF
IEC61850 GGIO4 Analog 3 db	100.000 %

UNIDAD N1 - C. FLORIDA 3.URS

C:\USERS\CDIAZ\DESKTOP\PROTECCIONES\PROTECCIONES\BACK-UP RELES DE PROTECCION\

DEVICE DEFINITION

FILES

ORDER CODE: G30-N03-HKH-F8L-H6C-M8N-P6D-UXX-WXX

VERSION: 5.7X

UR SERIAL NUMBER: AAKC09000130

SETTINGS SEND TO RELAY: TUESDAY, NOVEMBER 03, 2015 15:14:01

DESCRIPTION: (NONE)

TEXT COLOR

GGIO4 ANALOG CONFIGURATION (continued from last page)

IEC61850 GGIO4 Analog 3 min	0.000
IEC61850 GGIO4 Analog 3 max	1000000.000
IEC61850 GGIO4 Analog 4 Value	OFF
IEC61850 GGIO4 Analog 4 db	100.000 %
IEC61850 GGIO4 Analog 4 min	0.000
IEC61850 GGIO4 Analog 4 max	1000000.000
IEC61850 GGIO4 Analog 5 Value	OFF
IEC61850 GGIO4 Analog 5 db	100.000 %
IEC61850 GGIO4 Analog 5 min	0.000
IEC61850 GGIO4 Analog 5 max	1000000.000
IEC61850 GGIO4 Analog 6 Value	OFF
IEC61850 GGIO4 Analog 6 db	100.000 %
IEC61850 GGIO4 Analog 6 min	0.000
IEC61850 GGIO4 Analog 6 max	1000000.000
IEC61850 GGIO4 Analog 7 Value	OFF
IEC61850 GGIO4 Analog 7 db	100.000 %
IEC61850 GGIO4 Analog 7 min	0.000
IEC61850 GGIO4 Analog 7 max	1000000.000
IEC61850 GGIO4 Analog 8 Value	OFF
IEC61850 GGIO4 Analog 8 db	100.000 %
IEC61850 GGIO4 Analog 8 min	0.000
IEC61850 GGIO4 Analog 8 max	1000000.000
IEC61850 GGIO4 Analog 9 Value	OFF
IEC61850 GGIO4 Analog 9 db	100.000 %
IEC61850 GGIO4 Analog 9 min	0.000
IEC61850 GGIO4 Analog 9 max	1000000.000
IEC61850 GGIO4 Analog 10 Value	OFF
IEC61850 GGIO4 Analog 10 db	100.000 %
IEC61850 GGIO4 Analog 10 min	0.000
IEC61850 GGIO4 Analog 10 max	1000000.000
IEC61850 GGIO4 Analog 11 Value	OFF
IEC61850 GGIO4 Analog 11 db	100.000 %
IEC61850 GGIO4 Analog 11 min	0.000
IEC61850 GGIO4 Analog 11 max	1000000.000
IEC61850 GGIO4 Analog 12 Value	OFF
IEC61850 GGIO4 Analog 12 db	100.000 %
IEC61850 GGIO4 Analog 12 min	0.000
IEC61850 GGIO4 Analog 12 max	1000000.000
IEC61850 GGIO4 Analog 13 Value	OFF
IEC61850 GGIO4 Analog 13 db	100.000 %
IEC61850 GGIO4 Analog 13 min	0.000
IEC61850 GGIO4 Analog 13 max	1000000.000
IEC61850 GGIO4 Analog 14 Value	OFF
IEC61850 GGIO4 Analog 14 db	100.000 %
IEC61850 GGIO4 Analog 14 min	0.000
IEC61850 GGIO4 Analog 14 max	1000000.000
IEC61850 GGIO4 Analog 15 Value	OFF
IEC61850 GGIO4 Analog 15 db	100.000 %
IEC61850 GGIO4 Analog 15 min	0.000
IEC61850 GGIO4 Analog 15 max	1000000.000
IEC61850 GGIO4 Analog 16 Value	OFF
IEC61850 GGIO4 Analog 16 db	100.000 %
IEC61850 GGIO4 Analog 16 min	0.000
IEC61850 GGIO4 Analog 16 max	1000000.000
IEC61850 GGIO4 Analog 17 Value	OFF
IEC61850 GGIO4 Analog 17 db	100.000 %
IEC61850 GGIO4 Analog 17 min	0.000
IEC61850 GGIO4 Analog 17 max	1000000.000
IEC61850 GGIO4 Analog 18 Value	OFF
IEC61850 GGIO4 Analog 18 db	100.000 %
IEC61850 GGIO4 Analog 18 min	0.000
IEC61850 GGIO4 Analog 18 max	1000000.000
IEC61850 GGIO4 Analog 19 Value	OFF
IEC61850 GGIO4 Analog 19 db	100.000 %
IEC61850 GGIO4 Analog 19 min	0.000
IEC61850 GGIO4 Analog 19 max	1000000.000
IEC61850 GGIO4 Analog 20 Value	OFF
IEC61850 GGIO4 Analog 20 db	100.000 %
IEC61850 GGIO4 Analog 20 min	0.000
IEC61850 GGIO4 Analog 20 max	1000000.000
IEC61850 GGIO4 Analog 21 Value	OFF

UNIDAD N1 - C. FLORIDA 3.URS

C:\USERS\CDIAZ\DESKTOP\PROTECCIONES\PROTECCIONES\BACK-UP RELES DE PROTECCION\

DEVICE DEFINITION

FILES

ORDER CODE: G30-N03-HKH-F8L-H6C-M8N-P6D-UXX-WXX

VERSION: 5.7X

UR SERIAL NUMBER: AAKC09000130

SETTINGS SEND TO RELAY: TUESDAY, NOVEMBER 03, 2015 15:14:01

DESCRIPTION: (NONE)

TEXT COLOR

GGIO4 ANALOG CONFIGURATION (continued from last page)

IEC61850 GGIO4 Analog 21 db	100.000 %
IEC61850 GGIO4 Analog 21 min	0.000
IEC61850 GGIO4 Analog 21 max	1000000.000
IEC61850 GGIO4 Analog 22 Value	OFF
IEC61850 GGIO4 Analog 22 db	100.000 %
IEC61850 GGIO4 Analog 22 min	0.000
IEC61850 GGIO4 Analog 22 max	1000000.000
IEC61850 GGIO4 Analog 23 Value	OFF
IEC61850 GGIO4 Analog 23 db	100.000 %
IEC61850 GGIO4 Analog 23 min	0.000
IEC61850 GGIO4 Analog 23 max	1000000.000
IEC61850 GGIO4 Analog 24 Value	OFF
IEC61850 GGIO4 Analog 24 db	100.000 %
IEC61850 GGIO4 Analog 24 min	0.000
IEC61850 GGIO4 Analog 24 max	1000000.000
IEC61850 GGIO4 Analog 25 Value	OFF
IEC61850 GGIO4 Analog 25 db	100.000 %
IEC61850 GGIO4 Analog 25 min	0.000
IEC61850 GGIO4 Analog 25 max	1000000.000
IEC61850 GGIO4 Analog 26 Value	OFF
IEC61850 GGIO4 Analog 26 db	100.000 %
IEC61850 GGIO4 Analog 26 min	0.000
IEC61850 GGIO4 Analog 26 max	1000000.000
IEC61850 GGIO4 Analog 27 Value	OFF
IEC61850 GGIO4 Analog 27 db	100.000 %
IEC61850 GGIO4 Analog 27 min	0.000
IEC61850 GGIO4 Analog 27 max	1000000.000
IEC61850 GGIO4 Analog 28 Value	OFF
IEC61850 GGIO4 Analog 28 db	100.000 %
IEC61850 GGIO4 Analog 28 min	0.000
IEC61850 GGIO4 Analog 28 max	1000000.000
IEC61850 GGIO4 Analog 29 Value	OFF
IEC61850 GGIO4 Analog 29 db	100.000 %
IEC61850 GGIO4 Analog 29 min	0.000
IEC61850 GGIO4 Analog 29 max	1000000.000
IEC61850 GGIO4 Analog 30 Value	OFF
IEC61850 GGIO4 Analog 30 db	100.000 %
IEC61850 GGIO4 Analog 30 min	0.000
IEC61850 GGIO4 Analog 30 max	1000000.000
IEC61850 GGIO4 Analog 31 Value	OFF
IEC61850 GGIO4 Analog 31 db	100.000 %
IEC61850 GGIO4 Analog 31 min	0.000
IEC61850 GGIO4 Analog 31 max	1000000.000
IEC61850 GGIO4 Analog 32 Value	OFF
IEC61850 GGIO4 Analog 32 db	100.000 %
IEC61850 GGIO4 Analog 32 min	0.000
IEC61850 GGIO4 Analog 32 max	1000000.000

REPORT CONTROL CONFIGURATION

REPORT 1 (GGIO1.BR): RptID	
REPORT 1 (GGIO1.BR): OptFlds	0
REPORT 1 (GGIO1.BR): BufTm	0
REPORT 1 (GGIO1.BR): TrgOps	0
REPORT 1 (GGIO1.BR): IntgPd	0
REPORT 2 (GGIO1.BR01): RptID	
REPORT 2 (GGIO1.BR01): OptFlds	0
REPORT 2 (GGIO1.BR01): BufTm	0
REPORT 2 (GGIO1.BR01): TrgOps	0
REPORT 2 (GGIO1.BR01): IntgPd	0
REPORT 3 (GGIO1.RP): RptID	
REPORT 3 (GGIO1.RP): OptFlds	0
REPORT 3 (GGIO1.RP): BufTm	0
REPORT 3 (GGIO1.RP): TrgOps	0
REPORT 3 (GGIO1.RP): IntgPd	0
REPORT 4 (GGIO4.RP): RptID	
REPORT 4 (GGIO4.RP): OptFlds	0
REPORT 4 (GGIO4.RP): BufTm	0
REPORT 4 (GGIO4.RP): TrgOps	0
REPORT 4 (GGIO4.RP): IntgPd	0
REPORT 5 (MMXU1.BR): RptID	
REPORT 5 (MMXU1.BR): OptFlds	0

UNIDAD N1 - C. FLORIDA 3.URS

C:\USERS\CDIAZ\DESKTOP\PROTECCIONES\PROTECCIONES\BACK-UP RELES DE PROTECCION\

DEVICE DEFINITION

FILES

ORDER CODE: G30-N03-HKH-F8L-H6C-M8N-P6D-UXX-WXX

VERSION: 5.7X

UR SERIAL NUMBER: AAKC09000130

SETTINGS SEND TO RELAY: TUESDAY, NOVEMBER 03, 2015 15:14:01

DESCRIPTION: (NONE)

TEXT COLOR

REPORT CONTROL CONFIGURATION (continued from last page)

REPORT 5 (MMXU1.BR): BufTm	0
REPORT 5 (MMXU1.BR): TrgOps	0
REPORT 5 (MMXU1.BR): IntgPd	0
REPORT 6 (MMXU1.RP): RptID	
REPORT 6 (MMXU1.RP): OptFlds	0
REPORT 6 (MMXU1.RP): BufTm	0
REPORT 6 (MMXU1.RP): TrgOps	0
REPORT 6 (MMXU1.RP): IntgPd	0
REPORT 7 (MMXU2.BR): RptID	
REPORT 7 (MMXU2.BR): OptFlds	0
REPORT 7 (MMXU2.BR): BufTm	0
REPORT 7 (MMXU2.BR): TrgOps	0
REPORT 7 (MMXU2.BR): IntgPd	0
REPORT 8 (MMXU2.RP): RptID	
REPORT 8 (MMXU2.RP): OptFlds	0
REPORT 8 (MMXU2.RP): BufTm	0
REPORT 8 (MMXU2.RP): TrgOps	0
REPORT 8 (MMXU2.RP): IntgPd	0
REPORT 9 (MMXU3.BR): RptID	
REPORT 9 (MMXU3.BR): OptFlds	0
REPORT 9 (MMXU3.BR): BufTm	0
REPORT 9 (MMXU3.BR): TrgOps	0
REPORT 9 (MMXU3.BR): IntgPd	0
REPORT 10 (MMXU3.RP): RptID	
REPORT 10 (MMXU3.RP): OptFlds	0
REPORT 10 (MMXU3.RP): BufTm	0
REPORT 10 (MMXU3.RP): TrgOps	0
REPORT 10 (MMXU3.RP): IntgPd	0
REPORT 11 (MMXU4.BR): RptID	
REPORT 11 (MMXU4.BR): OptFlds	0
REPORT 11 (MMXU4.BR): BufTm	0
REPORT 11 (MMXU4.BR): TrgOps	0
REPORT 11 (MMXU4.BR): IntgPd	0
REPORT 12 (MMXU4.RP): RptID	
REPORT 12 (MMXU4.RP): OptFlds	0
REPORT 12 (MMXU4.RP): BufTm	0
REPORT 12 (MMXU4.RP): TrgOps	0
REPORT 12 (MMXU4.RP): IntgPd	0

XCBR CONFIGURATION

XCBR1 ST.Loc Operand	OFF
Clear XCBR1 OpCnt	No
XCBR2 ST.Loc Operand	OFF
Clear XCBR2 OpCnt	No
XCBR3 ST.Loc Operand	OFF
Clear XCBR3 OpCnt	No
XCBR4 ST.Loc Operand	OFF
Clear XCBR4 OpCnt	No

XSWI CONFIGURATION

XSWI1 ST.Loc Operand	OFF
XSWI2 ST.Loc Operand	OFF
XSWI3 ST.Loc Operand	OFF
XSWI4 ST.Loc Operand	OFF
XSWI5 ST.Loc Operand	OFF
XSWI6 ST.Loc Operand	OFF
XSWI7 ST.Loc Operand	OFF
XSWI8 ST.Loc Operand	OFF
XSWI9 ST.Loc Operand	OFF
XSWI10 ST.Loc Operand	OFF
XSWI11 ST.Loc Operand	OFF
XSWI12 ST.Loc Operand	OFF
XSWI13 ST.Loc Operand	OFF
XSWI14 ST.Loc Operand	OFF
XSWI15 ST.Loc Operand	OFF
XSWI16 ST.Loc Operand	OFF
Clear XSWI1 OpCnt	No
Clear XSWI2 OpCnt	No
Clear XSWI3 OpCnt	No
Clear XSWI4 OpCnt	No
Clear XSWI5 OpCnt	No

UNIDAD N1 - C. FLORIDA 3.URS

C:\USERS\CDIAZ\DESKTOP\PROTECCIONES\PROTECCIONES\BACK-UP RELES DE PROTECCION\

DEVICE DEFINITION

FILES

ORDER CODE: G30-N03-HKH-F8L-H6C-M8N-P6D-UXX-WXX

VERSION: 5.7X

UR SERIAL NUMBER: AAKC09000130

SETTINGS SEND TO RELAY: TUESDAY, NOVEMBER 03, 2015 15:14:01

DESCRIPTION: (NONE)

TEXT COLOR

XSWI CONFIGURATION (continued from last page)

Clear XSWI6 OpCnt	No
Clear XSWI7 OpCnt	No
Clear XSWI8 OpCnt	No
Clear XSWI9 OpCnt	No
Clear XSWI10 OpCnt	No
Clear XSWI11 OpCnt	No
Clear XSWI12 OpCnt	No
Clear XSWI13 OpCnt	No
Clear XSWI14 OpCnt	No
Clear XSWI15 OpCnt	No
Clear XSWI16 OpCnt	No

HTTP

HTTP TCP Port Number	80
----------------------	----

TFTP

TFTP Main UDP Port Number	69
TFTP Data UDP Port Number 1	0
TFTP Data UDP Port Number 2	0

SNTP

Function	Enabled
Server IP Address	192.168. 31.100
UDP Port Number	123

REAL TIME CLOCK

IRIG-B Signal Type	None
Real Time Clock Events	Disabled
Time Zone Offset	-3.0 hr
DST Function	Disabled

OSCILLOGRAPHY

Number Of Records	5
Trigger Mode	Automatic Overwrite
Trigger Position	30 %
Trigger Source	OSCILOGRAFIA On (VO7)
AC Input Waveforms	32 samples/cycle
Digital Channel 1	XFMR PCNT DIFF OP
Digital Channel 2	XFMR PCNT DIFF OP A
Digital Channel 3	XFMR PCNT DIFF OP B
Digital Channel 4	XFMR PCNT DIFF OP C
Digital Channel 5	DIR POWER 1 OP
Digital Channel 6	PHASE TOC1 OP
Digital Channel 7	PHASE TOC1 OP A
Digital Channel 8	PHASE TOC1 OP B
Digital Channel 9	PHASE TOC1 OP C
Digital Channel 10	NEUTRAL TOC1 OP
Digital Channel 11	PHASE UV1 OP A
Digital Channel 12	PHASE UV1 OP B
Digital Channel 13	PHASE UV1 OP C
Digital Channel 14	PHASE OV1 OP
Digital Channel 15	PHASE OV1 OP A
Digital Channel 16	PHASE OV1 OP B
Digital Channel 17	PHASE OV1 OP C
Digital Channel 18	AUX OV 1 OP
Digital Channel 19	OVERFREQ 1 OP
Digital Channel 20	UNDERFREQ 1 OP
Digital Channel 21	VOLTS PER HERTZ 1 OP
Digital Channel 22	LOSS EXCIT OP
Digital Channel 23	ACCDNT ENRG OP
Digital Channel 24	EXT TRIP1 On (VO1)
Digital Channel 25	EXT TRIP2 On (VO2)
Digital Channel 26	F FUSIBLE4 On (VO4)
Digital Channel 27	SRC1 VT FUSE FAIL OP
Analog Channel 1	Xfmr Iad Mag
Analog Channel 2	Xfmr Iar Mag
Analog Channel 3	Xfmr Harm2 Iad Mag
Analog Channel 4	Xfmr Ibd Mag
Analog Channel 5	Xfmr Ibr Mag
Analog Channel 6	Xfmr Harm2 Ibd Mag
Analog Channel 7	Xfmr Icd Mag

UNIDAD N1 - C. FLORIDA 3.URS

C:\USERS\CDIAZ\DESKTOP\PROTECCIONES\PROTECCIONES\BACK-UP RELES DE PROTECCION\

DEVICE DEFINITION

FILES

ORDER CODE: G30-N03-HKH-F8L-H6C-M8N-P6D-UXX-WXX

VERSION: 5.7X

UR SERIAL NUMBER: AAKC09000130

SETTINGS SEND TO RELAY: TUESDAY, NOVEMBER 03, 2015 15:14:01

DESCRIPTION: (NONE)

TEXT COLOR

OSCILLOGRAPHY (continued from last page)

Analog Channel 8	Xfmr Icr Mag
Analog Channel 9	Xfmr Harm2 Icd Mag
Analog Channel 10	RGF 1 Igd Mag
Analog Channel 11	RGF 1 Igr Mag
Analog Channel 12	SRC1 In RMS
Analog Channel 13	SRC1 Ig Mag
Analog Channel 14	Stator Gnd Vn 3rd
Analog Channel 15	Stator Gnd Vn+V0 3rd
Analog Channel 16	Tracking Frequency

DATA LOGGER

Data Logger Mode	Continuous
Data Logger Trigger	OFF
Rate	60000 msec

USER-PROGRAMMABLE LEADS

USER PROGRAMMABLE LEADS

LED 1: OPERAND	TRIP On (VO3)
LED 1: TYPE	Latched
LED 2: OPERAND	F FUSIBLE4 On (VO4)
LED 2: TYPE	Latched
LED 3: OPERAND	EXT TRIP1 On (VO1)
LED 3: TYPE	Latched
LED 4: OPERAND	EXT TRIP2 On (VO2)
LED 4: TYPE	Latched
LED 5: OPERAND	XFMR PCNT DIFF OP
LED 5: TYPE	Latched
LED 6: OPERAND	PHASE TOC1 OP
LED 6: TYPE	Latched
LED 7: OPERAND	GROUND TOC1 OP
LED 7: TYPE	Latched
LED 8: OPERAND	PHASE UV1 OP A
LED 8: TYPE	Latched
LED 9: OPERAND	PHASE UV1 OP B
LED 9: TYPE	Latched
LED 10: OPERAND	PHASE UV1 OP C
LED 10: TYPE	Latched
LED 11: OPERAND	PHASE OV1 OP
LED 11: TYPE	Latched
LED 12: OPERAND	AUX OV 1 OP
LED 12: TYPE	Latched
LED 13: OPERAND	VOLTS PER HERTZ 1 OP
LED 13: TYPE	Latched
LED 14: OPERAND	LOSS EXCIT OP
LED 14: TYPE	Latched
LED 15: OPERAND	ACCDNT ENRG OP
LED 15: TYPE	Latched
LED 16: OPERAND	DIR POWER 1 OP
LED 16: TYPE	Latched
LED 17: OPERAND	UNDERFREQ 1 OP
LED 17: TYPE	Latched
LED 18: OPERAND	OVERFREQ 1 OP
LED 18: TYPE	Latched
LED 19: OPERAND	50BF On (VO6)
LED 19: TYPE	Latched

USER-PROGRAMMABLE SELF TESTS

Remote Device Off Function	Enabled
Battery Fail Function	Enabled
SNTP Fail Function	Enabled
IRIG B Fail Function	Enabled

USER-DEFINABLE DISPLAYS

USER DISPLAY 1: Top Line	Florida 3
USER DISPLAY 1: Bottom Line	Unidad 1
USER DISPLAY 1: Item 1	0
USER DISPLAY 1: Item 2	0
USER DISPLAY 1: Item 3	0
USER DISPLAY 1: Item 4	0
USER DISPLAY 1: Item 5	0
Invoke and Scroll	OFF

UNIDAD N1 - C. FLORIDA 3.URS

C:\USERS\CDIAZ\DESKTOP\PROTECCIONES\PROTECCIONES\BACK-UP RELES DE PROTECCION\

DEVICE DEFINITION

FILES

ORDER CODE: G30-N03-HKH-F8L-H6C-M8N-P6D-UXX-WXX

VERSION: 5.7X

UR SERIAL NUMBER: AAKC09000130

SETTINGS SEND TO RELAY: TUESDAY, NOVEMBER 03, 2015 15:14:01

DESCRIPTION: (NONE)

TEXT COLOR

INSTALLATION

Relay Name Relay-1

SYSTEM SETUP

AC INPUTS

CURRENT

CT F1: Phase CT Primary	400 A
CT F1: Phase CT Secondary	5 A
CT F1: Ground CT Primary	1 A
CT F1: Ground CT Secondary	1 A
CT M1: Phase CT Primary	400 A
CT M1: Phase CT Secondary	5 A
CT M1: Ground CT Primary	5 A
CT M1: Ground CT Secondary	5 A
CT M5: Phase CT Primary	1 A
CT M5: Phase CT Secondary	1 A
CT M5: Ground CT Primary	1 A
CT M5: Ground CT Secondary	1 A

VOLTAGE

VT F5: Phase VT Connection	Wye
VT F5: Phase VT Secondary	57.7 V
VT F5: Phase VT Ratio	24.00 :1
VT F5: Auxiliary VT Connection	Vn
VT F5: Auxiliary VT Secondary	70.0 V
VT F5: Auxiliary VT Ratio	20.00 :1

POWER SYSTEM

Nominal Frequency	50 Hz
Phase Rotation	ABC
Reverse Phase Rotation	OFF
Frequency And Phase Reference	linea (SRC 2)
Frequency Tracking Function	Enabled

SIGNAL SOURCES

SOURCE 1: Name	neutro
SOURCE 1: Phase CT	M1
SOURCE 1: Ground CT	M1
SOURCE 1: Phase VT	None
SOURCE 1: Auxiliary VT	F5
SOURCE 2: Name	linea
SOURCE 2: Phase CT	F1
SOURCE 2: Ground CT	None
SOURCE 2: Phase VT	F5
SOURCE 2: Auxiliary VT	None
SOURCE 3: Name	SCR3
SOURCE 3: Phase CT	M5
SOURCE 3: Ground CT	M1
SOURCE 3: Phase VT	None
SOURCE 3: Auxiliary VT	None

TRANSFORMER

GENERAL

Reference Winding Selection	Automatic Selection
Phase Compensation	Internal (software)

WINDINGS

WINDING 1: Source	linea (SRC 2)
WINDING 1: Rated MVA	1.650 MVA
WINDING 1: Nominal Phs-phs Voltage	2.400 kV
WINDING 1: Connection	Wye
WINDING 1: Grounding	Not within zone
WINDING 1: Angle Wrt Winding 1	0.0 deg
WINDING 2: Source	neutro (SRC 1)
WINDING 2: Rated MVA	1.650 MVA
WINDING 2: Nominal Phs-phs Voltage	2.400 kV
WINDING 2: Connection	Wye
WINDING 2: Grounding	Not within zone
WINDING 2: Angle Wrt Winding 1	-180.0 deg

UNIDAD N1 - C. FLORIDA 3.URS

C:\USERS\CDIAZ\DESKTOP\PROTECCIONES\PROTECCIONES\BACK-UP RELES DE PROTECCION\

DEVICE DEFINITION

FILES

ORDER CODE: G30-N03-HKH-F8L-H6C-M8N-P6D-UXX-WXX

VERSION: 5.7X

UR SERIAL NUMBER: AAKC09000130

SETTINGS SEND TO RELAY: TUESDAY, NOVEMBER 03, 2015 15:14:01

DESCRIPTION: (NONE)

TEXT COLOR

FLEXLOGIC EQUATION EDITOR

FlexLogic Entry 1	SRC2 VT FUSE FAIL OP
FlexLogic Entry 2	Cont Ip 7 On(P4a)
FlexLogic Entry 3	OR(2)
FlexLogic Entry 4	= F FUSIBLE4 (VO4)
FlexLogic Entry 5	UNDERFREQ 1 OP
FlexLogic Entry 6	OVERFREQ 1 OP
FlexLogic Entry 7	XFMR PCNT DIFF OP
FlexLogic Entry 8	PHASE TOC1 OP
FlexLogic Entry 9	GROUND TOC1 OP
FlexLogic Entry 10	PHASE UV1 OP
FlexLogic Entry 11	PHASE UV2 OP
FlexLogic Entry 12	50BF On (VO6)
FlexLogic Entry 13	PHASE OV1 OP
FlexLogic Entry 14	AUX OV 1 OP
FlexLogic Entry 15	VOLTS PER HERTZ 1 OP
FlexLogic Entry 16	LOSS EXCIT OP
FlexLogic Entry 17	ACCDNT ENRG OP
FlexLogic Entry 18	DIR POWER 1 OP
FlexLogic Entry 19	EXT TRIP1 On (VO1)
FlexLogic Entry 20	EXT TRIP2 On (VO2)
FlexLogic Entry 21	OR(16)
FlexLogic Entry 22	= TRIP (VO3)
FlexLogic Entry 23	Cont Ip 2 On(P1c)
FlexLogic Entry 24	Cont Ip 3 On(P2a)
FlexLogic Entry 25	OR(2)
FlexLogic Entry 26	= EXT TRIP1 (VO1)
FlexLogic Entry 27	Cont Ip 4 On(P2c)
FlexLogic Entry 28	Cont Ip 5 On(P3a)
FlexLogic Entry 29	Cont Ip 6 On(P3c)
FlexLogic Entry 30	OR(3)
FlexLogic Entry 31	= EXT TRIP2 (VO2)
FlexLogic Entry 32	TRIP On (VO3)
FlexLogic Entry 33	NOT
FlexLogic Entry 34	= NOT TRIP (VO5)
FlexLogic Entry 35	PHASE IOC1 OP
FlexLogic Entry 36	NEUTRAL IOC1 OP
FlexLogic Entry 37	OR(2)
FlexLogic Entry 38	TRIP On (VO3)
FlexLogic Entry 39	AND(2)
FlexLogic Entry 40	TIMER 2
FlexLogic Entry 41	= 50BF (VO6)
FlexLogic Entry 42	TRIP On (VO3)
FlexLogic Entry 43	POSITIVE ONE SHOT
FlexLogic Entry 44	50BF On (VO6)
FlexLogic Entry 45	POSITIVE ONE SHOT
FlexLogic Entry 46	OR(2)
FlexLogic Entry 47	TIMER 1
FlexLogic Entry 48	= OSCIOGRAFIA (VO7)
FlexLogic Entry 49	END

FLEXLOGIC TIMERS

Timer 1: Type	millisecond
Timer 1: Pickup Delay	0
Timer 1: Dropout Delay	200
Timer 2: Type	millisecond
Timer 2: Pickup Delay	800
Timer 2: Dropout Delay	0

GROUPED ELEMENTS

GROUP 1

TRANSFORMER

PERCENT DIFFERENTIAL [GROUP 1]

Function	Enabled
Pickup	0.200 pu
Slope 1	15 %
Break 1	2.000 pu
Break 2	30.000 pu
Slope 2	50 %
Inrush Inhibit Function	Adapt. 2nd
Inrush Inhibit Mode	Per phase
Inrush Inhibit Level	10.0 % fo

UNIDAD N1 - C. FLORIDA 3.URS

C:\USERS\CDIAZ\DESKTOP\PROTECCIONES\PROTECCIONES\BACK-UP RELES DE PROTECCION\

DEVICE DEFINITION

FILES

ORDER CODE: G30-N03-HKH-F8L-H6C-M8N-P6D-UXX-WXX

VERSION: 5.7X

UR SERIAL NUMBER: AAKC09000130

SETTINGS SEND TO RELAY: TUESDAY, NOVEMBER 03, 2015 15:14:01

DESCRIPTION: (NONE)

TEXT COLOR

PERCENT DIFFERENTIAL [GROUP 1] (continued from last page)

Overexcitation Inhibit Function	Disabled
Overexcitation Inhibit Level	20.0 % fo
Block	OFF
Target	Self-reset
Events	Enabled

PHASE CURRENT

PHASE TOC [GROUP 1]

PHASE TOC1: Function	Enabled
PHASE TOC1: Signal Source	neutro (SRC 1)
PHASE TOC1: Input	RMS
PHASE TOC1: Pickup	1.100 pu
PHASE TOC1: Curve	Definite Time
PHASE TOC1: TD Multiplier	5.00
PHASE TOC1: Reset	Instantaneous
PHASE TOC1: Voltage Restraint	Enabled
PHASE TOC1: Block A	OFF
PHASE TOC1: Block B	OFF
PHASE TOC1: Block C	OFF
PHASE TOC1: Target	Self-reset
PHASE TOC1: Events	Enabled

PHASE IOC [GROUP 1]

PHASE IOC1: Function	Enabled
PHASE IOC1: Source	linea (SRC 2)
PHASE IOC1: Pickup	0.100 pu
PHASE IOC1: Delay	0.00 s
PHASE IOC1: Reset Delay	0.00 s
PHASE IOC1: Block A	OFF
PHASE IOC1: Block B	OFF
PHASE IOC1: Block C	OFF
PHASE IOC1: Target	Self-reset
PHASE IOC1: Events	Enabled

GROUND CURRENT

GROUND TOC [GROUP 1]

GROUND TOC1: Function	Enabled
GROUND TOC1: Source	neutro (SRC 1)
GROUND TOC1: Input	RMS
GROUND TOC1: Pickup	0.200 pu
GROUND TOC1: Curve	Definite Time
GROUND TOC1: TD Multiplier	0.10
GROUND TOC1: Reset	Instantaneous
GROUND TOC1: Block	OFF
GROUND TOC1: Target	Self-reset
GROUND TOC1: Events	Enabled

VOLTAGE ELEMENTS

PHASE UV [GROUP 1]

PHASE UV1: Function	Enabled
PHASE UV1: Signal Source	linea (SRC 2)
PHASE UV1: Mode	Phase to Phase
PHASE UV1: Pickup	0.850 pu
PHASE UV1: Curve	Definite Time
PHASE UV1: Delay	2.00 s
PHASE UV1: Minimum Voltage	0.100 pu
PHASE UV1: Block	Cont Ip 1 On(P1a)
PHASE UV1: Target	Self-reset
PHASE UV1: Events	Enabled

PHASE OV [GROUP 1]

PHASE OV1: Function	Enabled
PHASE OV1: Source	linea (SRC 2)
PHASE OV1: Pickup	1.150 pu
PHASE OV1: Delay	1.60 s
PHASE OV1: Reset Delay	1.00 s
PHASE OV1: Block	OFF
PHASE OV1: Target	Self-reset
PHASE OV1: Events	Enabled

AUXILIARY OV [GROUP 1]

UNIDAD N1 - C. FLORIDA 3.URS

C:\USERS\CDIAZ\DESKTOP\PROTECCIONES\PROTECCIONES\BACK-UP RELES DE PROTECCION\

DEVICE DEFINITION

FILES

ORDER CODE: G30-N03-HKH-F8L-H6C-M8N-P6D-UXX-WXX

VERSION: 5.7X

UR SERIAL NUMBER: AAKC09000130

SETTINGS SEND TO RELAY: TUESDAY, NOVEMBER 03, 2015 15:14:01

DESCRIPTION: (NONE)

TEXT COLOR

AUXILIARY OV [GROUP 1] (continued from last page)

AUXILIARY OV 1: Function	Enabled
AUXILIARY OV 1: Source	neutro (SRC 1)
AUXILIARY OV 1: Pickup	0.100 pu
AUXILIARY OV 1: Pickup Delay	0.60 s
AUXILIARY OV 1: Reset Delay	1.00 s
AUXILIARY OV 1: Block	OFF
AUXILIARY OV 1: Target	Self-reset
AUXILIARY OV 1: Events	Enabled

VOLTS PER HERTZ [GROUP 1]

VOLTS PER HERTZ 1: Function	Enabled
VOLTS PER HERTZ 1: Source	linea (SRC 2)
VOLTS PER HERTZ 1: Pickup	1.15 pu
VOLTS PER HERTZ 1: Curves	Definite Time
VOLTS PER HERTZ 1: TD Multiplier	30.00
VOLTS PER HERTZ 1: T Reset	1.0 s
VOLTS PER HERTZ 1: Block	OFF
VOLTS PER HERTZ 1: Target	Self-reset
VOLTS PER HERTZ 1: Events	Enabled

LOSS OF EXCITATION [GROUP 1]

Function	Enabled
Source	linea (SRC 2)
Center 1	6.90 ohm
Radius 1	5.80 ohm
UV Supervision Enable 1	Disabled
Pickup Delay 1	0.120 s
Center 2	12.15 ohm
Radius 2	11.05 ohm
UV Supervision Enable 2	Disabled
Pickup Delay 2	0.600 s
UV Supervision	0.100 pu
Block	F FUSIBLE4 On (VO4)
Target	Self-reset
Events	Enabled

ACCIDENTAL ENERGIZATION [GROUP 1]

Function	Enabled
Source	linea (SRC 2)
Accidental Energization Arming Mode	UV AND OFFLINE
Accidental Energization OC Pickup	0.100
Accidental Energization UV Pickup	0.600
Accidental Energization Offline	OFF
Block	OFF
Target	Self-reset
Events	Enabled

STATOR GROUND

STATOR GROUND SOURCE [GROUP 1]

Source	neutro (SRC 1)
--------	----------------

POWER

SENSITIVE DIRECTIONAL POWER

SENSITIVE DIRECTIONAL POWER [GROUP 1]

SENS DIR POWER1: Function	Enabled
SENS DIR POWER1: Signal Source	linea (SRC 2)
SENS DIR POWER1: Sensitive Directional Power RCA	180 deg
SENS DIR POWER1: Sensitive Directional Power Calibration	0.00 deg
SENS DIR POWER1: Stage 1 SMIN	0.010 pu
SENS DIR POWER1: Stage 1 Delay	4.00 s
SENS DIR POWER1: Stage 2 SMIN	0.010 pu
SENS DIR POWER1: Stage 2 Delay	4.00 s
SENS DIR POWER1: Block	F FUSIBLE4 On (VO4)
SENS DIR POWER1: Target	Self-reset
SENS DIR POWER1: Events	Enabled

CONTROL ELEMENTS

UNDERFREQUENCY

UNDERFREQUENCY 1: Function	Enabled
UNDERFREQUENCY 1: Block	Cont Ip 1 On(P1a)
UNDERFREQUENCY 1: Source	linea (SRC 2)

UNIDAD N1 - C. FLORIDA 3.URS

C:\USERS\CDIAZ\DESKTOP\PROTECCIONES\PROTECCIONES\BACK-UP RELES DE PROTECCION\

DEVICE DEFINITION

FILES

ORDER CODE: G30-N03-HKH-F8L-H6C-M8N-P6D-UXX-WXX

VERSION: 5.7X

UR SERIAL NUMBER: AAKC09000130

SETTINGS SEND TO RELAY: TUESDAY, NOVEMBER 03, 2015 15:14:01

DESCRIPTION: (NONE)

TEXT COLOR

UNDERFREQUENCY (continued from last page)

UNDERFREQUENCY 1: Min Volt/Amp	0.10 pu
UNDERFREQUENCY 1: Pickup	48.00 Hz
UNDERFREQUENCY 1: Pickup Delay	1.600 s
UNDERFREQUENCY 1: Reset Delay	2.000 s
UNDERFREQUENCY 1: Target	Self-reset
UNDERFREQUENCY 1: Events	Enabled

OVERFREQUENCY

OVERFREQUENCY 1: Function	Enabled
OVERFREQUENCY 1: Block	Cont Ip 1 On(P1a)
OVERFREQUENCY 1: Source	linea (SRC 2)
OVERFREQUENCY 1: Pickup	52.00 Hz
OVERFREQUENCY 1: Pickup Delay	1.600 s
OVERFREQUENCY 1: Reset Delay	0.500 s
OVERFREQUENCY 1: Target	Self-reset
OVERFREQUENCY 1: Events	Enabled

FREQUENCY OOB ACCUMULATION

Freq OOB Accumulator Source	neutro (SRC 1)
Freq OOB Accumulator Min V A	0.10 pu
Freq OOB Accumulator Block	OFF
Freq OOB Accumulator Target	Self-reset
Freq OOB Accumulator Events	Disabled

INPUTS/OUTPUTS

CONTACT INPUTS

[P1A] Contact Input 1 ID	Cont Ip 1
[P1A] Contact Input 1 Debounce Time	2.0 ms
[P1A] Contact Input 1 Events	Disabled
[P1C] Contact Input 2 ID	Cont Ip 2
[P1C] Contact Input 2 Debounce Time	2.0 ms
[P1C] Contact Input 2 Events	Disabled
[P2A] Contact Input 3 ID	Cont Ip 3
[P2A] Contact Input 3 Debounce Time	2.0 ms
[P2A] Contact Input 3 Events	Disabled
[P2C] Contact Input 4 ID	Cont Ip 4
[P2C] Contact Input 4 Debounce Time	2.0 ms
[P2C] Contact Input 4 Events	Disabled
[P3A] Contact Input 5 ID	Cont Ip 5
[P3A] Contact Input 5 Debounce Time	2.0 ms
[P3A] Contact Input 5 Events	Disabled
[P3C] Contact Input 6 ID	Cont Ip 6
[P3C] Contact Input 6 Debounce Time	2.0 ms
[P3C] Contact Input 6 Events	Disabled
[P4A] Contact Input 7 ID	Cont Ip 7
[P4A] Contact Input 7 Debounce Time	2.0 ms
[P4A] Contact Input 7 Events	Disabled
[P4C] Contact Input 8 ID	Cont Ip 8
[P4C] Contact Input 8 Debounce Time	2.0 ms
[P4C] Contact Input 8 Events	Disabled
[P5A] Contact Input 9 ID	Cont Ip 9
[P5A] Contact Input 9 Debounce Time	2.0 ms
[P5A] Contact Input 9 Events	Disabled
[P5C] Contact Input 10 ID	Cont Ip 10
[P5C] Contact Input 10 Debounce Time	2.0 ms
[P5C] Contact Input 10 Events	Disabled
[P6A] Contact Input 11 ID	Cont Ip 11
[P6A] Contact Input 11 Debounce Time	2.0 ms
[P6A] Contact Input 11 Events	Disabled
[P6C] Contact Input 12 ID	Cont Ip 12
[P6C] Contact Input 12 Debounce Time	2.0 ms
[P6C] Contact Input 12 Events	Disabled
[P7A] Contact Input 13 ID	Cont Ip 13
[P7A] Contact Input 13 Debounce Time	2.0 ms
[P7A] Contact Input 13 Events	Disabled
[P7C] Contact Input 14 ID	Cont Ip 14
[P7C] Contact Input 14 Debounce Time	2.0 ms
[P7C] Contact Input 14 Events	Disabled
[P8A] Contact Input 15 ID	Cont Ip 15
[P8A] Contact Input 15 Debounce Time	2.0 ms
[P8A] Contact Input 15 Events	Disabled

UNIDAD N1 - C. FLORIDA 3.URS

C:\USERS\CDIAZ\DESKTOP\PROTECCIONES\PROTECCIONES\BACK-UP RELES DE PROTECCION\

DEVICE DEFINITION

FILES

ORDER CODE: G30-N03-HKH-F8L-H6C-M8N-P6D-UXX-WXX

VERSION: 5.7X

UR SERIAL NUMBER: AAKC09000130

SETTINGS SEND TO RELAY: TUESDAY, NOVEMBER 03, 2015 15:14:01

DESCRIPTION: (NONE)

TEXT COLOR

CONTACT INPUTS (continued from last page)

[P8C] Contact Input 16 ID	Cont Ip 16
[P8C] Contact Input 16 Debounce Time	2.0 ms
[P8C] Contact Input 16 Events	Disabled

CONTACT INPUT THRESHOLDS

Cont Ip 1, Cont Ip 2, Cont Ip 3, Cont Ip 4(P1a, P1c, P2a, P2c)	33 Vdc
Cont Ip 5, Cont Ip 6, Cont Ip 7, Cont Ip 8(P3a, P3c, P4a, P4c)	33 Vdc
Cont Ip 9, Cont Ip 10, Cont Ip 11, Cont Ip 12(P5a, P5c, P6a, P6c)	33 Vdc
Cont Ip 13, Cont Ip 14, Cont Ip 15, Cont Ip 16(P7a, P7c, P8a, P8c)	33 Vdc

CONTACT OUTPUTS

[H1] Contact Output 1 ID	Cont Op 1
[H1] Contact Output 1 Operate	TRIP On (VO3)
[H1] Contact Output 1 Seal-In	OFF
[H1] Contact Output 1 Events	Enabled
[H2] Contact Output 2 ID	Cont Op 2
[H2] Contact Output 2 Operate	ANY SELF TESTS
[H2] Contact Output 2 Seal-In	OFF
[H2] Contact Output 2 Events	Enabled
[H3] Contact Output 3 ID	Cont Op 3
[H3] Contact Output 3 Operate	50BF On (VO6)
[H3] Contact Output 3 Seal-In	OFF
[H3] Contact Output 3 Events	Enabled
[H4] Contact Output 4 ID	Cont Op 4
[H4] Contact Output 4 Operate	TRIP On (VO3)
[H4] Contact Output 4 Seal-In	OFF
[H4] Contact Output 4 Events	Enabled
[H6] Contact Output 6 ID	Cont Op 6
[H6] Contact Output 6 Operate	TRIP On (VO3)
[H6] Contact Output 6 Seal-In	OFF
[H6] Contact Output 6 Events	Enabled
[H7] Contact Output 7 ID	Cont Op 7
[H7] Contact Output 7 Operate	TRIP On (VO3)
[H7] Contact Output 7 Seal-In	OFF
[H7] Contact Output 7 Events	Enabled
[H8] Contact Output 8 ID	Cont Op 8
[H8] Contact Output 8 Operate	TRIP On (VO3)
[H8] Contact Output 8 Seal-In	OFF
[H8] Contact Output 8 Events	Enabled

VIRTUAL OUTPUTS

Virtual Output 1 ID	EXT TRIP1
Virtual Output 1 Events	Enabled
Virtual Output 2 ID	EXT TRIP2
Virtual Output 2 Events	Enabled
Virtual Output 3 ID	TRIP
Virtual Output 3 Events	Enabled
Virtual Output 4 ID	F FUSIBLE4
Virtual Output 4 Events	Disabled
Virtual Output 5 ID	NOT TRIP
Virtual Output 5 Events	Enabled
Virtual Output 6 ID	50BF
Virtual Output 6 Events	Enabled
Virtual Output 7 ID	OSCILOGRAFIA
Virtual Output 7 Events	Disabled

REMOTE DEVICES

Remote Device 1 ID	Remote Device 1
Remote Device 1 ETYPE APPID	0
Remote Device 1 DATASET	Fixed
Remote Device 2 ID	Remote Device 2
Remote Device 2 ETYPE APPID	0
Remote Device 2 DATASET	Fixed
Remote Device 3 ID	Remote Device 3
Remote Device 3 ETYPE APPID	0
Remote Device 3 DATASET	Fixed
Remote Device 4 ID	Remote Device 4
Remote Device 4 ETYPE APPID	0
Remote Device 4 DATASET	Fixed
Remote Device 5 ID	Remote Device 5
Remote Device 5 ETYPE APPID	0

UNIDAD N1 - C. FLORIDA 3.URS

C:\USERS\CDIAZ\DESKTOP\PROTECCIONES\PROTECCIONES\BACK-UP RELES DE PROTECCION\

DEVICE DEFINITION

FILES

ORDER CODE: G30-N03-HKH-F8L-H6C-M8N-P6D-UXX-WXX

VERSION: 5.7X

UR SERIAL NUMBER: AAKC09000130

SETTINGS SEND TO RELAY: TUESDAY, NOVEMBER 03, 2015 15:14:01

DESCRIPTION: (NONE)

TEXT COLOR

REMOTE DEVICES (continued from last page)

Remote Device 5 DATASET	Fixed
Remote Device 6 ID	Remote Device 6
Remote Device 6 ETYPE APPID	0
Remote Device 6 DATASET	Fixed
Remote Device 7 ID	Remote Device 7
Remote Device 7 ETYPE APPID	0
Remote Device 7 DATASET	Fixed
Remote Device 8 ID	Remote Device 8
Remote Device 8 ETYPE APPID	0
Remote Device 8 DATASET	Fixed
Remote Device 9 ID	Remote Device 9
Remote Device 9 ETYPE APPID	0
Remote Device 9 DATASET	Fixed
Remote Device 10 ID	Remote Device 10
Remote Device 10 ETYPE APPID	0
Remote Device 10 DATASET	Fixed
Remote Device 11 ID	Remote Device 11
Remote Device 11 ETYPE APPID	0
Remote Device 11 DATASET	Fixed
Remote Device 12 ID	Remote Device 12
Remote Device 12 ETYPE APPID	0
Remote Device 12 DATASET	Fixed
Remote Device 13 ID	Remote Device 13
Remote Device 13 ETYPE APPID	0
Remote Device 13 DATASET	Fixed
Remote Device 14 ID	Remote Device 14
Remote Device 14 ETYPE APPID	0
Remote Device 14 DATASET	Fixed
Remote Device 15 ID	Remote Device 15
Remote Device 15 ETYPE APPID	0
Remote Device 15 DATASET	Fixed
Remote Device 16 ID	Remote Device 16
Remote Device 16 ETYPE APPID	0
Remote Device 16 DATASET	Fixed

IEC 61850 GOOSE ANALOGS INPUTS

IEC61850 GOOSE Analog Input 1 Default Value	1000.000
IEC61850 GOOSE Analog Input 1 Mode	Default Value
IEC61850 GOOSE Analog Input 1 Units	
IEC61850 GOOSE Analog Input 1 PU Base	1.000
IEC61850 GOOSE Analog Input 2 Default Value	1000.000
IEC61850 GOOSE Analog Input 2 Mode	Default Value
IEC61850 GOOSE Analog Input 2 Units	
IEC61850 GOOSE Analog Input 2 PU Base	1.000
IEC61850 GOOSE Analog Input 3 Default Value	1000.000
IEC61850 GOOSE Analog Input 3 Mode	Default Value
IEC61850 GOOSE Analog Input 3 Units	
IEC61850 GOOSE Analog Input 3 PU Base	1.000
IEC61850 GOOSE Analog Input 4 Default Value	1000.000
IEC61850 GOOSE Analog Input 4 Mode	Default Value
IEC61850 GOOSE Analog Input 4 Units	
IEC61850 GOOSE Analog Input 4 PU Base	1.000
IEC61850 GOOSE Analog Input 5 Default Value	1000.000
IEC61850 GOOSE Analog Input 5 Mode	Default Value
IEC61850 GOOSE Analog Input 5 Units	
IEC61850 GOOSE Analog Input 5 PU Base	1.000
IEC61850 GOOSE Analog Input 6 Default Value	1000.000
IEC61850 GOOSE Analog Input 6 Mode	Default Value
IEC61850 GOOSE Analog Input 6 Units	
IEC61850 GOOSE Analog Input 6 PU Base	1.000
IEC61850 GOOSE Analog Input 7 Default Value	1000.000
IEC61850 GOOSE Analog Input 7 Mode	Default Value
IEC61850 GOOSE Analog Input 7 Units	
IEC61850 GOOSE Analog Input 7 PU Base	1.000
IEC61850 GOOSE Analog Input 8 Default Value	1000.000
IEC61850 GOOSE Analog Input 8 Mode	Default Value
IEC61850 GOOSE Analog Input 8 Units	
IEC61850 GOOSE Analog Input 8 PU Base	1.000
IEC61850 GOOSE Analog Input 9 Default Value	1000.000
IEC61850 GOOSE Analog Input 9 Mode	Default Value
IEC61850 GOOSE Analog Input 9 Units	

UNIDAD N1 - C. FLORIDA 3.URS

C:\USERS\CDIAZ\DESKTOP\PROTECCIONES\PROTECCIONES\BACK-UP RELES DE PROTECCION\

DEVICE DEFINITION

FILES

ORDER CODE: G30-N03-HKH-F8L-H6C-M8N-P6D-UXX-WXX

VERSION: 5.7X

UR SERIAL NUMBER: AAKC09000130

SETTINGS SEND TO RELAY: TUESDAY, NOVEMBER 03, 2015 15:14:01

DESCRIPTION: (NONE)

TEXT COLOR

IEC61850 GOOSE ANALOGS INPUTS (continued from last page)

IEC61850 GOOSE Analog Input 9 PU Base	1.000
IEC61850 GOOSE Analog Input 10 Default Value	1000.000
IEC61850 GOOSE Analog Input 10 Mode	Default Value
IEC61850 GOOSE Analog Input 10 Units	
IEC61850 GOOSE Analog Input 10 PU Base	1.000
IEC61850 GOOSE Analog Input 11 Default Value	1000.000
IEC61850 GOOSE Analog Input 11 Mode	Default Value
IEC61850 GOOSE Analog Input 11 Units	
IEC61850 GOOSE Analog Input 11 PU Base	1.000
IEC61850 GOOSE Analog Input 12 Default Value	1000.000
IEC61850 GOOSE Analog Input 12 Mode	Default Value
IEC61850 GOOSE Analog Input 12 Units	
IEC61850 GOOSE Analog Input 12 PU Base	1.000
IEC61850 GOOSE Analog Input 13 Default Value	1000.000
IEC61850 GOOSE Analog Input 13 Mode	Default Value
IEC61850 GOOSE Analog Input 13 Units	
IEC61850 GOOSE Analog Input 13 PU Base	1.000
IEC61850 GOOSE Analog Input 14 Default Value	1000.000
IEC61850 GOOSE Analog Input 14 Mode	Default Value
IEC61850 GOOSE Analog Input 14 Units	
IEC61850 GOOSE Analog Input 14 PU Base	1.000
IEC61850 GOOSE Analog Input 15 Default Value	1000.000
IEC61850 GOOSE Analog Input 15 Mode	Default Value
IEC61850 GOOSE Analog Input 15 Units	
IEC61850 GOOSE Analog Input 15 PU Base	1.000
IEC61850 GOOSE Analog Input 16 Default Value	1000.000
IEC61850 GOOSE Analog Input 16 Mode	Default Value
IEC61850 GOOSE Analog Input 16 Units	
IEC61850 GOOSE Analog Input 16 PU Base	1.000
IEC61850 GOOSE Analog Input 17 Default Value	1000.000
IEC61850 GOOSE Analog Input 17 Mode	Default Value
IEC61850 GOOSE Analog Input 17 Units	
IEC61850 GOOSE Analog Input 17 PU Base	1.000
IEC61850 GOOSE Analog Input 18 Default Value	1000.000
IEC61850 GOOSE Analog Input 18 Mode	Default Value
IEC61850 GOOSE Analog Input 18 Units	
IEC61850 GOOSE Analog Input 18 PU Base	1.000
IEC61850 GOOSE Analog Input 19 Default Value	1000.000
IEC61850 GOOSE Analog Input 19 Mode	Default Value
IEC61850 GOOSE Analog Input 19 Units	
IEC61850 GOOSE Analog Input 19 PU Base	1.000
IEC61850 GOOSE Analog Input 20 Default Value	1000.000
IEC61850 GOOSE Analog Input 20 Mode	Default Value
IEC61850 GOOSE Analog Input 20 Units	
IEC61850 GOOSE Analog Input 20 PU Base	1.000
IEC61850 GOOSE Analog Input 21 Default Value	1000.000
IEC61850 GOOSE Analog Input 21 Mode	Default Value
IEC61850 GOOSE Analog Input 21 Units	
IEC61850 GOOSE Analog Input 21 PU Base	1.000
IEC61850 GOOSE Analog Input 22 Default Value	1000.000
IEC61850 GOOSE Analog Input 22 Mode	Default Value
IEC61850 GOOSE Analog Input 22 Units	
IEC61850 GOOSE Analog Input 22 PU Base	1.000
IEC61850 GOOSE Analog Input 23 Default Value	1000.000
IEC61850 GOOSE Analog Input 23 Mode	Default Value
IEC61850 GOOSE Analog Input 23 Units	
IEC61850 GOOSE Analog Input 23 PU Base	1.000
IEC61850 GOOSE Analog Input 24 Default Value	1000.000
IEC61850 GOOSE Analog Input 24 Mode	Default Value
IEC61850 GOOSE Analog Input 24 Units	
IEC61850 GOOSE Analog Input 24 PU Base	1.000
IEC61850 GOOSE Analog Input 25 Default Value	1000.000
IEC61850 GOOSE Analog Input 25 Mode	Default Value
IEC61850 GOOSE Analog Input 25 Units	
IEC61850 GOOSE Analog Input 25 PU Base	1.000
IEC61850 GOOSE Analog Input 26 Default Value	1000.000
IEC61850 GOOSE Analog Input 26 Mode	Default Value
IEC61850 GOOSE Analog Input 26 Units	
IEC61850 GOOSE Analog Input 26 PU Base	1.000
IEC61850 GOOSE Analog Input 27 Default Value	1000.000
IEC61850 GOOSE Analog Input 27 Mode	Default Value

UNIDAD N1 - C. FLORIDA 3.URS

C:\USERS\CDIAZ\DESKTOP\PROTECCIONES\PROTECCIONES\BACK-UP RELES DE PROTECCION\

DEVICE DEFINITION

FILES

ORDER CODE: G30-N03-HKH-F8L-H6C-M8N-P6D-UXX-WXX

VERSION: 5.7X

UR SERIAL NUMBER: AAKC09000130

SETTINGS SEND TO RELAY: TUESDAY, NOVEMBER 03, 2015 15:14:01

DESCRIPTION: (NONE)

TEXT COLOR

IEC 61850 GOOSE ANALOGS INPUTS (continued from last page)

IEC61850 GOOSE Analog Input 27 Units	
IEC61850 GOOSE Analog Input 27 PU Base	1.000
IEC61850 GOOSE Analog Input 28 Default Value	1000.000
IEC61850 GOOSE Analog Input 28 Mode	Default Value
IEC61850 GOOSE Analog Input 28 Units	
IEC61850 GOOSE Analog Input 28 PU Base	1.000
IEC61850 GOOSE Analog Input 29 Default Value	1000.000
IEC61850 GOOSE Analog Input 29 Mode	Default Value
IEC61850 GOOSE Analog Input 29 Units	
IEC61850 GOOSE Analog Input 29 PU Base	1.000
IEC61850 GOOSE Analog Input 30 Default Value	1000.000
IEC61850 GOOSE Analog Input 30 Mode	Default Value
IEC61850 GOOSE Analog Input 30 Units	
IEC61850 GOOSE Analog Input 30 PU Base	1.000
IEC61850 GOOSE Analog Input 31 Default Value	1000.000
IEC61850 GOOSE Analog Input 31 Mode	Default Value
IEC61850 GOOSE Analog Input 31 Units	
IEC61850 GOOSE Analog Input 31 PU Base	1.000
IEC61850 GOOSE Analog Input 32 Default Value	1000.000
IEC61850 GOOSE Analog Input 32 Mode	Default Value
IEC61850 GOOSE Analog Input 32 Units	
IEC61850 GOOSE Analog Input 32 PU Base	1.000

IEC 61850 GOOSE UINTEGERS INPUTS

IEC61850 GOOSE UInteger Input 1 Default Value	1000
IEC61850 GOOSE UInteger Input 1 Mode	Default Value
IEC61850 GOOSE UInteger Input 2 Default Value	1000
IEC61850 GOOSE UInteger Input 2 Mode	Default Value
IEC61850 GOOSE UInteger Input 3 Default Value	1000
IEC61850 GOOSE UInteger Input 3 Mode	Default Value
IEC61850 GOOSE UInteger Input 4 Default Value	1000
IEC61850 GOOSE UInteger Input 4 Mode	Default Value
IEC61850 GOOSE UInteger Input 5 Default Value	1000
IEC61850 GOOSE UInteger Input 5 Mode	Default Value
IEC61850 GOOSE UInteger Input 6 Default Value	1000
IEC61850 GOOSE UInteger Input 6 Mode	Default Value
IEC61850 GOOSE UInteger Input 7 Default Value	1000
IEC61850 GOOSE UInteger Input 7 Mode	Default Value
IEC61850 GOOSE UInteger Input 8 Default Value	1000
IEC61850 GOOSE UInteger Input 8 Mode	Default Value
IEC61850 GOOSE UInteger Input 9 Default Value	1000
IEC61850 GOOSE UInteger Input 9 Mode	Default Value
IEC61850 GOOSE UInteger Input 10 Default Value	1000
IEC61850 GOOSE UInteger Input 10 Mode	Default Value
IEC61850 GOOSE UInteger Input 11 Default Value	1000
IEC61850 GOOSE UInteger Input 11 Mode	Default Value
IEC61850 GOOSE UInteger Input 12 Default Value	1000
IEC61850 GOOSE UInteger Input 12 Mode	Default Value
IEC61850 GOOSE UInteger Input 13 Default Value	1000
IEC61850 GOOSE UInteger Input 13 Mode	Default Value
IEC61850 GOOSE UInteger Input 14 Default Value	1000
IEC61850 GOOSE UInteger Input 14 Mode	Default Value
IEC61850 GOOSE UInteger Input 15 Default Value	1000
IEC61850 GOOSE UInteger Input 15 Mode	Default Value
IEC61850 GOOSE UInteger Input 16 Default Value	1000
IEC61850 GOOSE UInteger Input 16 Mode	Default Value

1 Settings groups

1.1 Group Datos Generales de planta 2; Group General

Group Datos Generales de planta 2; Group General

No.	Settings	Value	Group
1101	Tens. nom.de servicio primaria de planta	0,40 kV	A
1102	Int.nom.de servicio primaria de planta	485 A	A
1108	Signo mat. de valores de serv. P,Q	no inverso	A

1.2 Group Protección sobreintensidad; Group General

Group Protección sobreintensidad; Group General

No.	Settings	Value	Group
1201	Prot. sobreintens. fases, t.def./t.inv.	Activar función	A
1213A	Cierre manual fases	I>> sin temporización	A
1215A	S/I t.def fase T retado repos. T RR	0,00 s	A
1301	Prot.sobreint.faltas a tierra,TDefi/TInv	Activar función	A
1313A	Cierre manual, Tierra	IE>> sin temporización	A
1315A	S/I t.def tierra T retado repos. T RR	0,00 s	A

1.3 Group Protección sobreintensidad; Group S/I t.def. fase

Group Protección sobreintensidad; Group S/I t.def. fase

No.	Settings	Value	Group
1219A	Medición I>>> de	Valor efectivo onda fundamental	A
1216A	I>>> activo	siempre	A
1217	Intensidad de arranque I>>>	oo A	A
1218	Temporización T I>>>	0,00 s	A
1220A	Medición I>> de	Valor efectivo onda fundamental	A
1214A	Escalón I>> Activo	siempre	A
1202	Inten.arranque escalón alta intens. I>>	oo A	A
1203	Temporización, escalón alta intens.T I>>	0,00 s	A
1221A	Medición I> de	Valor efectivo onda fundamental	A
1204	Inten.arranque, escalón intensidad. I>	18,40 A	A

Group Protección sobreintensidad; Group S/I t.def. fase(2)

No.	Settings	Value	Group
1205	Temporización, escalón intensidad. T I>	0,02 s	A

1.4 Group Protección sobreintensidad; Group S/I t.inv. fase

Group Protección sobreintensidad; Group S/I t.inv. fase

No.	Settings	Value	Group
1222A	Medición Ip de	Valor efectivo onda fundamental	A
1207	Valor de arranque Ip	5,60 A	A
1208	Factor de tiempo T Ip	1,00 s	A
1210	Reposición con emulación disco S/I t.inv	inmediato	A
1211	Característica disparo S/I t.inv. (IEC)	Extremadamente inversa	A
1223	Influencia de la tensión en S/I t inv.	No	A
1224	Umbral subtensión para autorización Ip	75,0 V	A

1.5 Group Protección sobreintensidad; Group S/I t.def.tierr

Group Protección sobreintensidad; Group S/I t.def.tierr

No.	Settings	Value	Group
1319A	Medición IE>>> de	Valor efectivo onda fundamental	A
1316A	IE>>> activo	siempre	A
1317	Intensidad de arranque IE>>>	oo A	A
1318	Temporización T IE>>>	0,00 s	A
1320A	Medición IE>> de	Valor efectivo onda fundamental	A
1314A	Escalón IE>> Activo	siempre	A
1302	Intensidad de arranque escalón IE>>	oo A	A
1303	Temporización, escalón T IE>>	0,00 s	A
1321A	Medición IE> de	Valor efectivo onda fundamental	A
1304	Intensidad de arranque escalón IE>	0,50 A	A
1305	Temporización,escalón T IE>	0,05 s	A

1.6 Group Protección de tensión; Group General

Group Protección de tensión; Group General

No.	Settings	Value	Group
5101	Subtensión	Activar función	A
5001	Sobretensión	Activar función	A

1.7 Group Protección de tensión; Group Subtensión

Group Protección de tensión; Group Subtensión

No.	Settings	Value	Group
5102	Tensión de arranque U<	93 V	A
5106	Temporización T U<	5,00 s	A
5110	Tensión de arranque U<<	80 V	A
5112	Temporización T U<<	2,00 s	A
5113A	Relación de reposición U<	1,03	A
5114A	Relación de reposición U<>	1,03	A
5120A	Criterio de intensidad	Activar función	A

1.8 Group Protección de tensión; Group Sobretensión

Group Protección de tensión; Group Sobretensión

No.	Settings	Value	Group
5002	Tensión de arranque U>	107 V	A
5004	Temporización T U>	5,00 s	A
5005	Tensión de arranque U>>	111 V	A
5007	Temporización T U>>	2,00 s	A
5017A	Relación de reposición U<	0,95	A
5018A	Relación de reposición U<<	0,95	A

1.9 Group Protección de frecuencia; Group General

Group Protección de frecuencia; Group General

No.	Settings	Value	Group
5401	Protección de frecuencia	Activar función	A
5421	Escalón de frecuencia F1	ON - Escalón de subfrecuencia	A
5422	Escalón de frecuencia F2	ON - Escalón de subfrecuencia	A
5423	Escalón de frecuencia F3	ON - Escalón de sobrefrecuencia	A
5424	Escalón de frecuencia F4	ON - Escalón de sobrefrecuencia	A
5402	Mínima Tensión	75 V	A
5415A	Diferencia de reposición	0,02 Hz	A

1.10 Group Protección de frecuencia; Group Prot. frecuenc.

Group Protección de frecuencia; Group Prot. frecuenc.

No.	Settings	Value	Group
5403	Valor de ajuste escalón f1	48,00 Hz	A
5405	Temporización del escalón T f1	15,00 s	A
5406	Valor de ajuste escalón f2	47,50 Hz	A
5408	Temporización del escalón T f2	5,00 s	A
5409	Valor de ajuste escalón f3	51,00 Hz	A
5411	Temporización del escalón T f3	90,00 s	A
5412	Valor de ajuste escalón f4	52,00 Hz	A
5414	Temporización del escalón T f4	15,00 s	A

1.11 Group Control de valores de medida; Group General

Group Control de valores de medida; Group General

No.	Settings	Value	Group
5301	Fallo fusible (Fuse-Failure-Monitor)	Desactivar función	A
5310	Bloqueo de la protección por FFM	Si	A
8101	Supervisión de valores de medida,	Activar función	A

1.12 Group Control de valores de medida; Group FFM

Group Control de valores de medida; Group FFM

No.	Settings	Value	Group
5302	Control fallo fusible límite 3*U0	30 V	A
5303	Control fallo fusible límite IE	0,50 A	A
5308A	U dif< para fallo de tensión tripolar	0,50 A	A

1.13 Group Control de valores de medida; Group Ctrl. val. med.

Group Control de valores de medida; Group Ctrl. val. med.

No.	Settings	Value	Group
8102	Simetría U: Valor de reacción	50 V	A
8103	Simetría U: Pendiente lín. caract.	0,75	A
8104	Simetría I fases: Valor de reacción	2,50 A	A
8105	Simetría I fases: Pendiente lín. caract.	0,50	A
8110A	Simetría U fase: Temporiz. de arranque	5 s	A
8111A	Simetría I fase: Temporiz. de arranque	5 s	A

1.14 Group Valores medios; Group Ajuste val.med.

Group Valores medios; Group Ajuste val.med.

No.	Settings	Value	Group
8301	Periodo para cálculo de valores medios	60 minutos periodo, 1 subperiodo	A
8302	Tiempo sinc. para valores medios	a hora completa	A

1.15 Group Valores mínimos y máximos; Group Ajuste val.med.

Group Valores mínimos y máximos; Group Ajuste val.med.

No.	Settings	Value	Group
8311	Reposición cíclica de valores mín/máx	Si	A
8312	Reposi. cíclic.Min/Max diaria cada X min	0 mín	A
8313	Reposi.. cíclic.Min/Max cada X días	7 días	A
8314	Inicio reposición. Mín/Máx en X días	1 Día(s)	A

1.16 Group Contador de energía; Group Ajuste val.med.

Group Contador de energía; Group Ajuste val.med.

No.	Settings	Value	Group
8315	Escala del Contador de Energia	Escala Standard	A

Name: Puntilla Folder S_I TRAFO PODER Var
Filename: C:\SIEMENS\DIGSI4\D4PROJ\PUNTILLA\P7DI\GV\ST\00000005\SAMPLES\FAULT\FR000014
Fault start: 16-04-2016 17:46:15:557
Scanning frequency:800 Hz

Cursor 1: 0 ms
Cursor 2: 291 ms
Representation: secondary

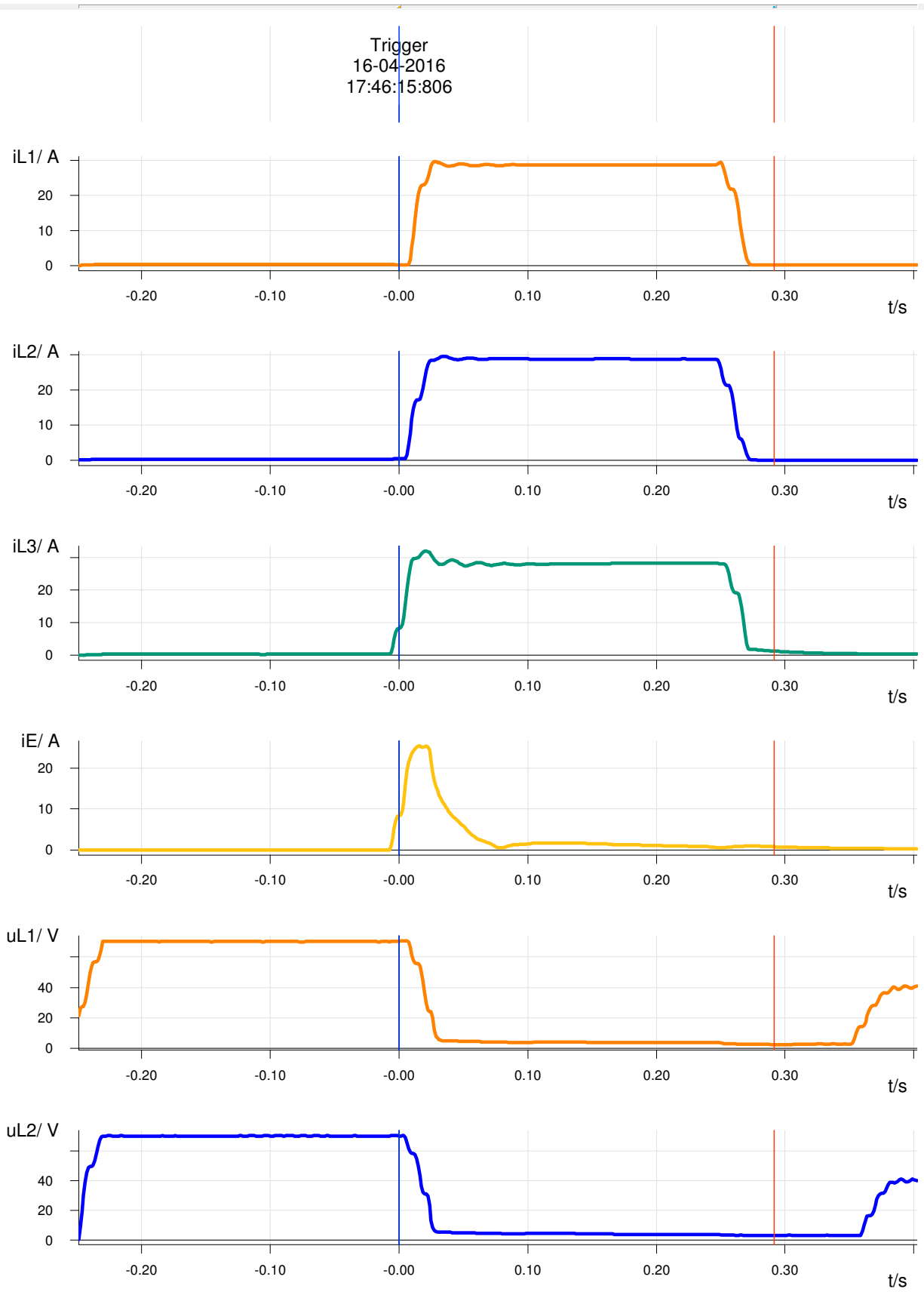

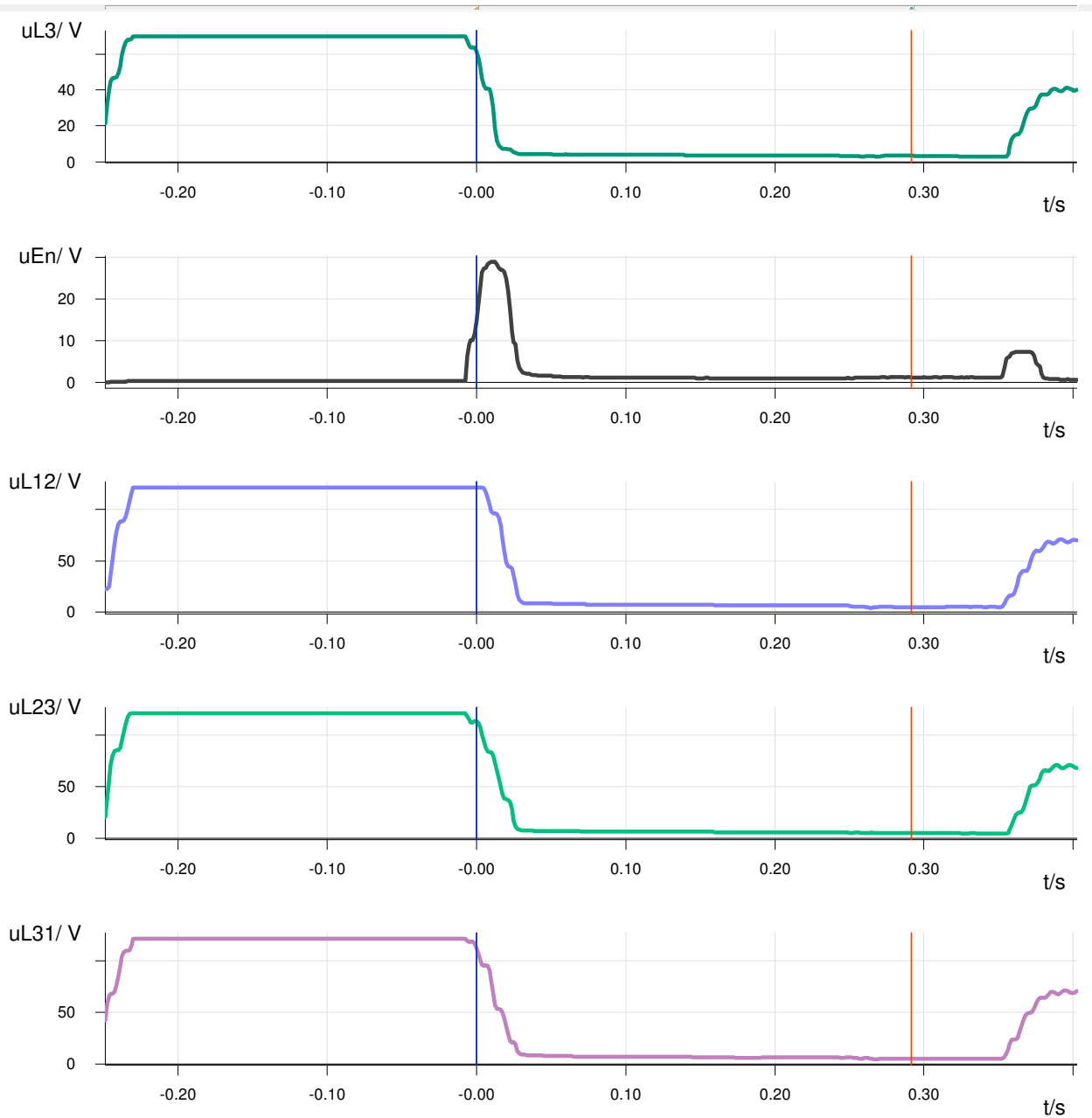

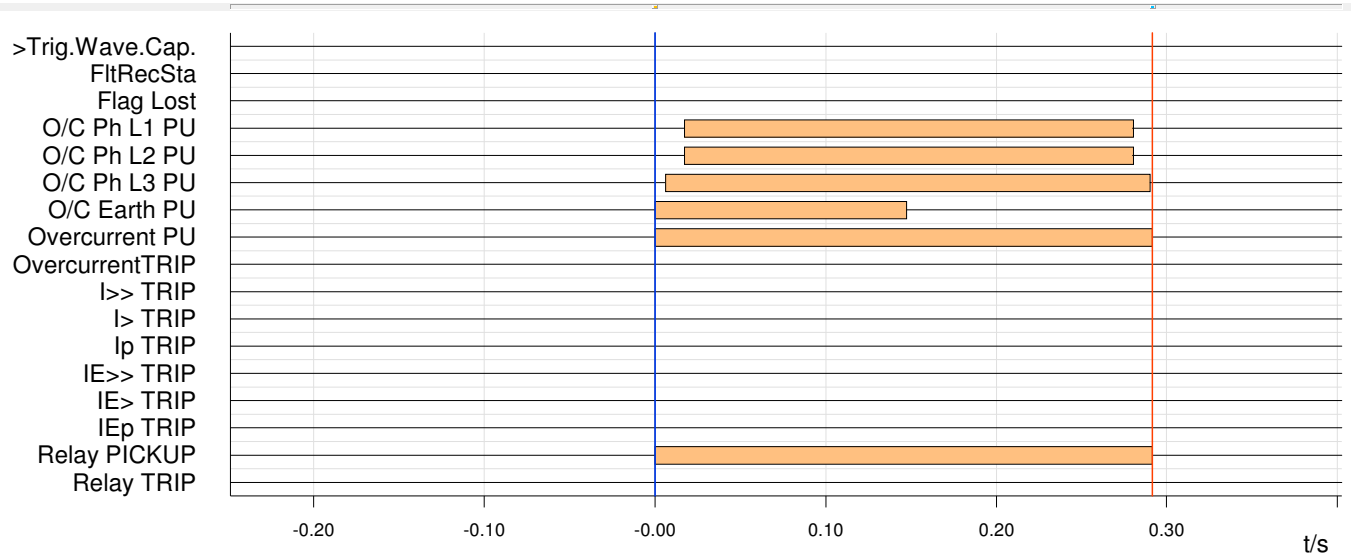

Name: Puntilla Folder FLORIDA 1 Var
Filename: C:\SIEMENS\DIGSI4\D4PROJ\PUNTILLA\P7D\GV\ST\00000007\SAMPLES\FAULT\FR000009
Fault start: 16-04-2016 19:20:31:666
Scanning frequency:800 Hz

Cursor 1: 0 ms
Cursor 2: 301 ms
Representation: secondary

Trigger
16-04-2016
19:20:31:915

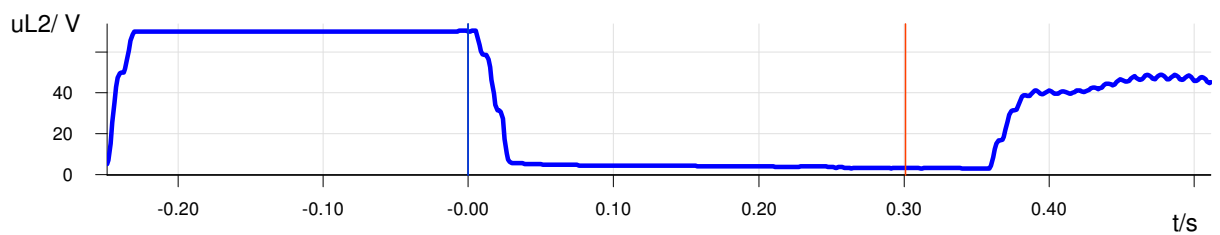
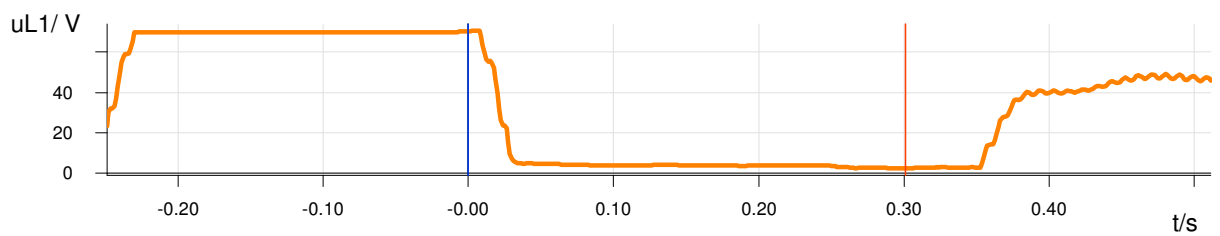
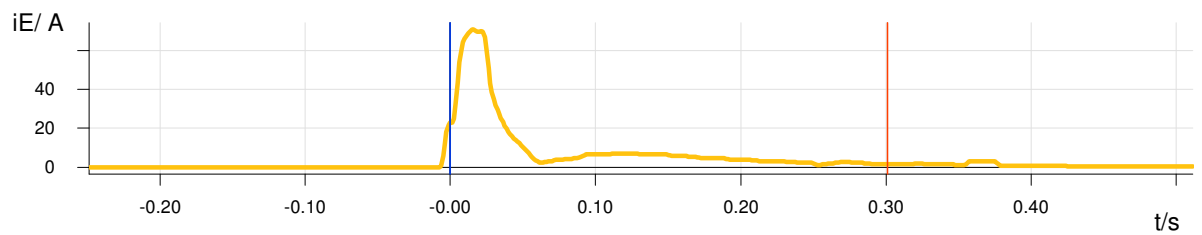
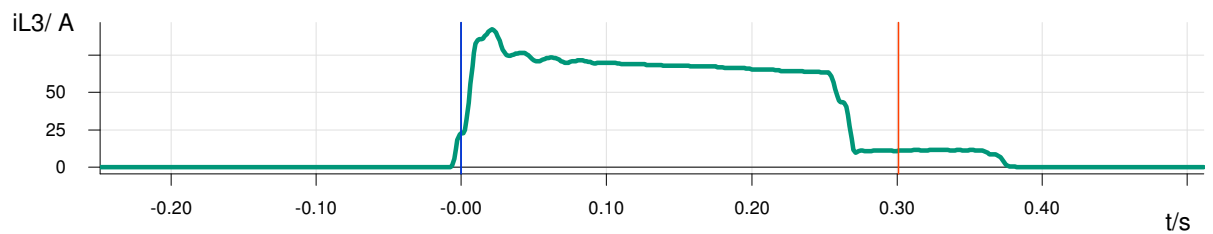
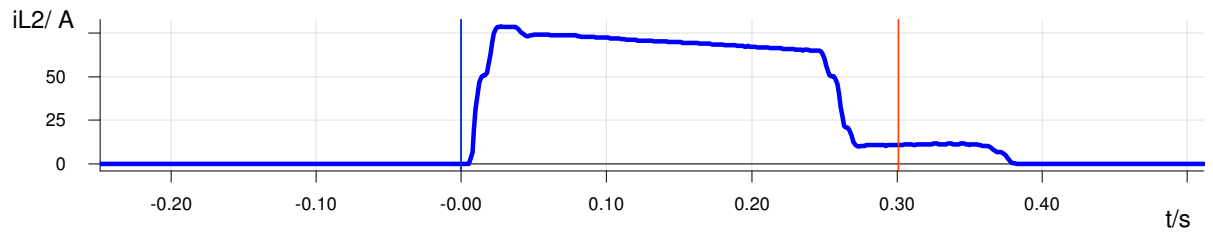
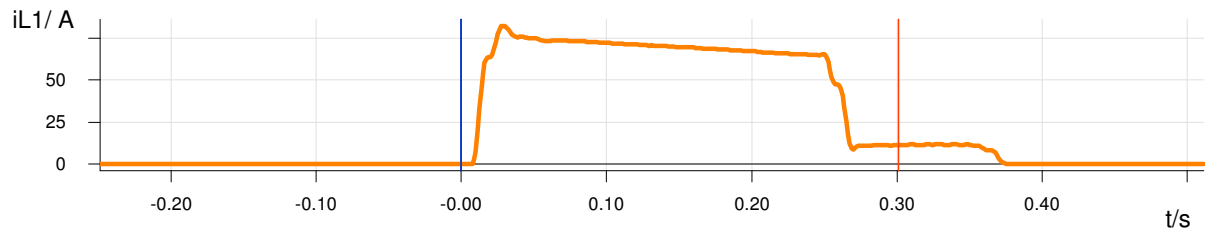

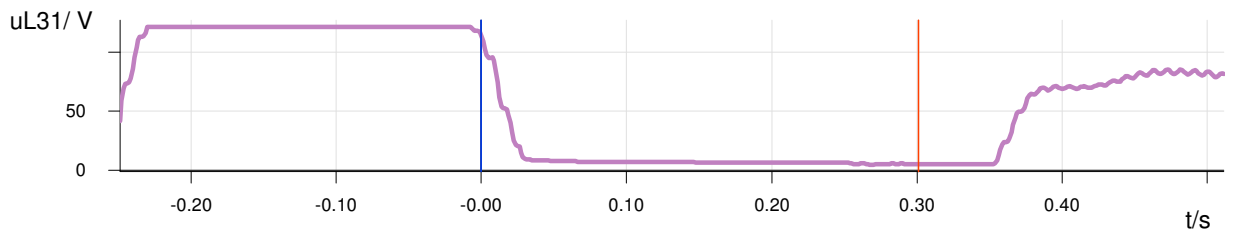
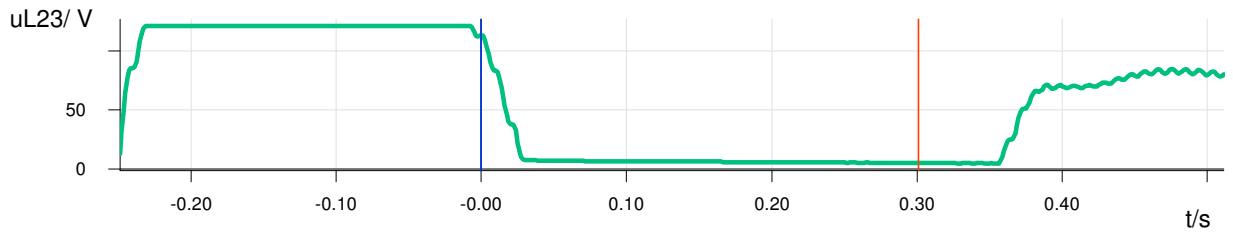
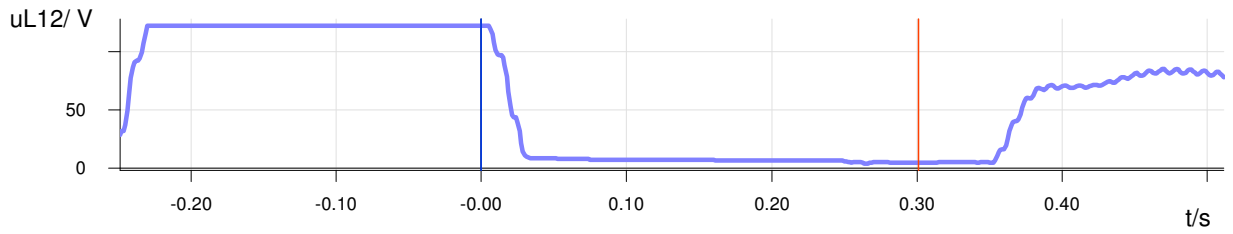
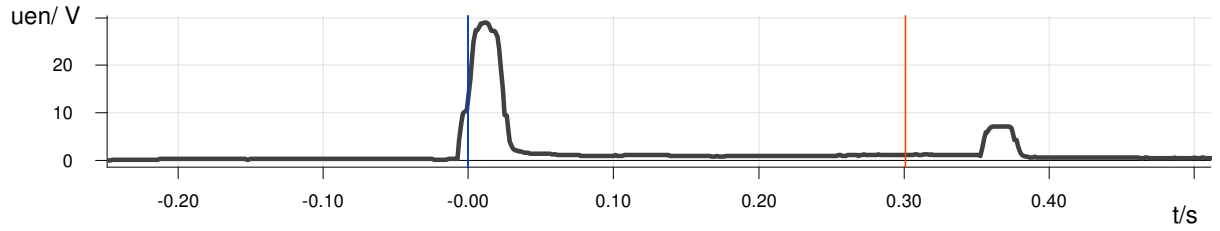
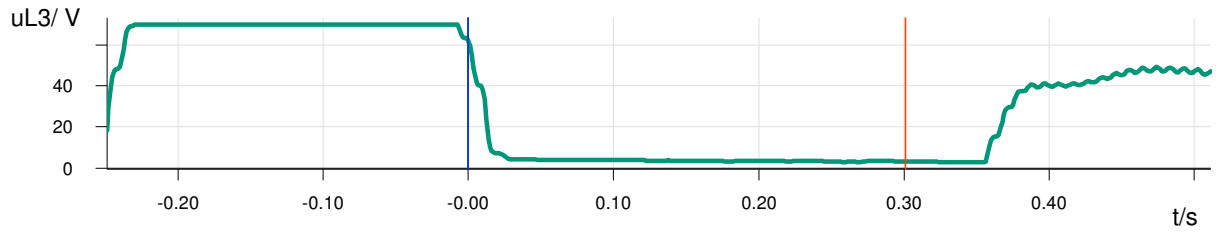

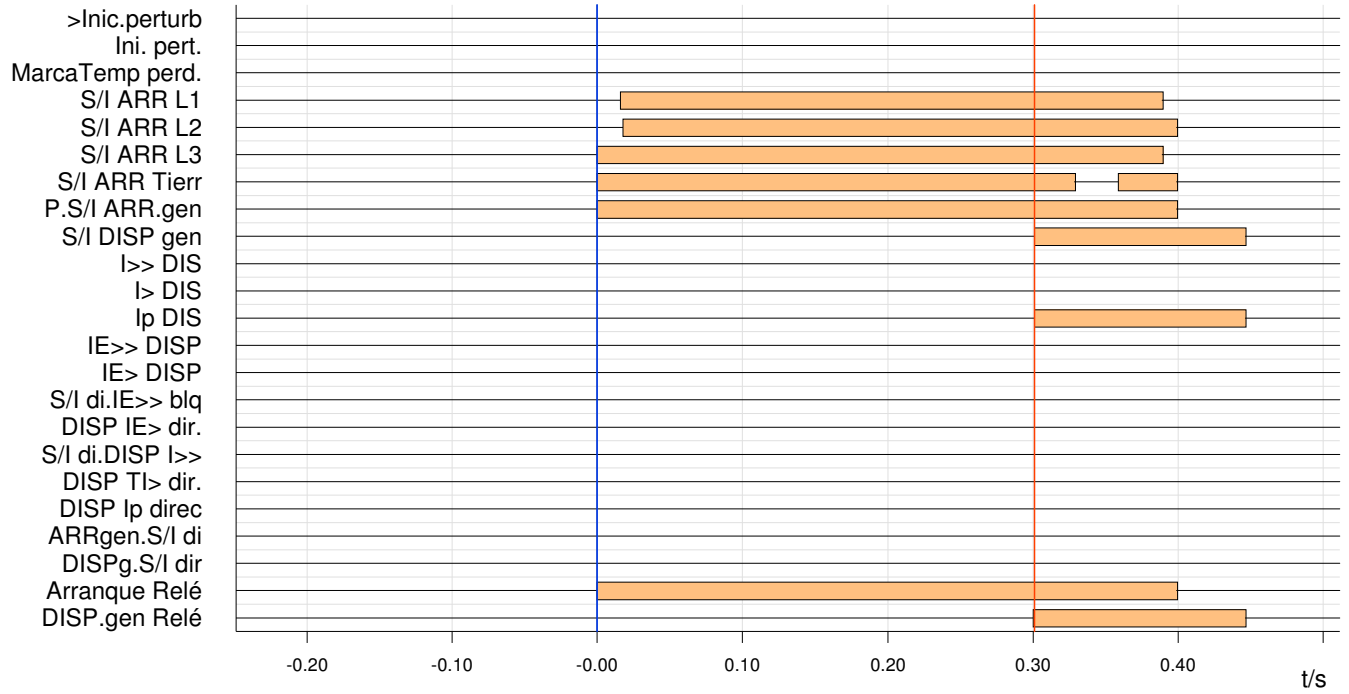

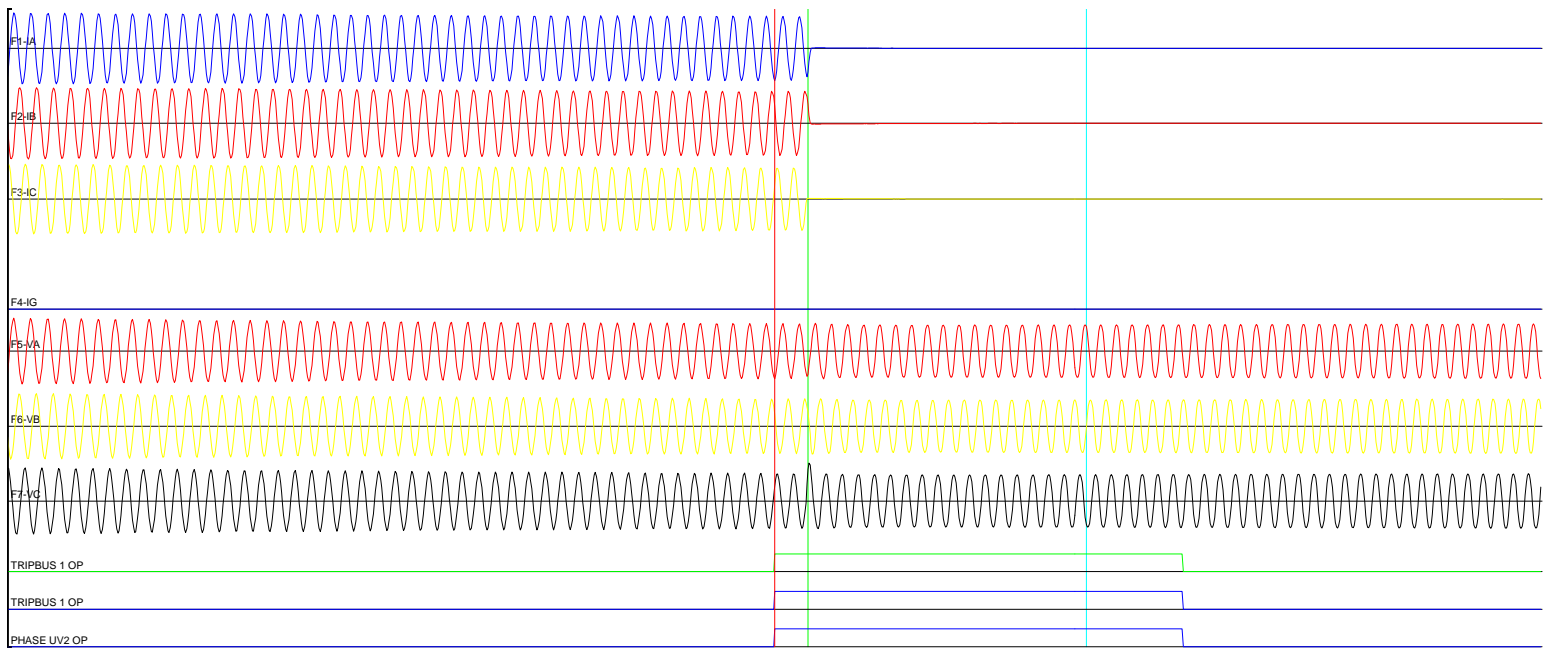

Oscillography Information

Comments

Cursor 1 = 1566.12 ms
Cursor 2 = 1169.42 ms
Delta = -396.71 ms
Trigger Date = 16/04/2016
Trigger Time = 19:18:34.756845

AXIS	CURSOR 1	CURSOR 2	DELTA
F1-IA	0.00A	-386.73A	-386.73A
F2-IB	-1.95A	310.56A	312.51A
F3-IC	0.00A	11.72A	11.72A
F4-IG	0.00A	-0.07A	-0.07A
F5-VA	6152.33V	-5823.96V	-11976.29V
F6-VB	-463.87V	3643.79V	4107.66V
F7-VC	-5858.14V	7873.51V	13731.65V
TRIPBUS 1 OP	Low	Low	-
TRIPBUS 1 OP	Low	Low	-
PHASE UV2 OP	High	High	-

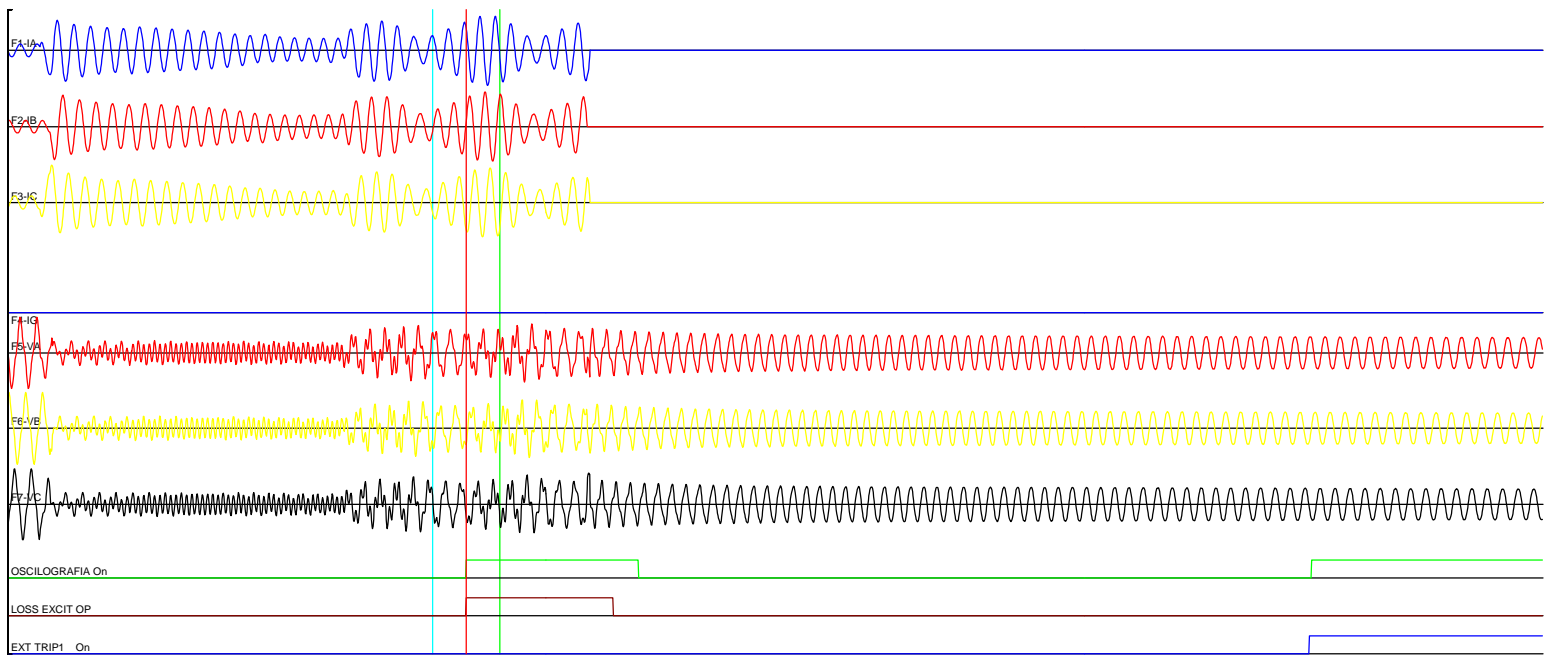

Oscillography Information

Comments

Cursor 1 = 503.59 ms
Cursor 2 = 583.14 ms
Delta = 79.56 ms
Trigger Date = 16/04/2016
Trigger Time = 19:18:31.049798

AXIS	CURSOR 1	CURSOR 2	DELTA
F1-IA	849.25A	-439.86A	-1289.11A
F2-IB	-284.39A	1826.63A	2111.02A
F3-IC	-574.24A	-1390.68A	-816.44A
F4-IG	-0.00A	0.00A	0.00A
F5-VA	1278.51V	450.29V	-828.22V
F6-VB	-888.86V	-773.14V	115.72V
F7-VC	538.48V	-1083.98V	-1622.46V
OSCILOGRAFIA On	Low	Low	-
LOSS EXCIT OP	Low	Low	-
EXT TRIP1 On	Low	Low	-



Nombre: puntilla Folder RINCON V4.9 Var

Ruta de ficheros:

C:\SIEMENS\DIGSI4\D4PROJ\PUNTILLA\P7D\IGV\ST\00000011\SAMPLES\FAULT\FR000013

Tiempo de inicio: 16-04-2016 21:05:06.618

Velocidad de datos: 800 Hz

Representación de valores: Secundario

Tipo de registro: COMTRADE



Disparo
16-04-2016
21:05:06.867

