

	<b>INFORME TÉCNICO DE LA PRUEBA: “POTENCIA MÁXIMA” CENTRAL PLACILLA (revisión 1)</b> Código: PPM-CEN024-2021-CC-DCO-0	
	miércoles 08 septiembre 2021	
Mandante	Revisión 1	Proveedor

# INFORME TÉCNICO DE LA PRUEBA: “POTENCIA MÁXIMA” CENTRAL PLACILLA

Código: PPM-CEN024-2021-CC-DCO-0

(Revisión 1)



Realiza	Francisco Gorigoitia Acuña	Revisa	Patricio Febre Cisternas	Aprueba	Coordinador Eléctrico Nacional
Cargo	Ingeniero de Proyectos	Cargo	Experto Técnico	Cargo	
Firma		Firma		Firma	
Fecha	08/09/2021	Fecha	08/09/2021	Fecha	08/09/2021

	<b>INFORME TÉCNICO DE LA PRUEBA: “POTENCIA MÁXIMA” CENTRAL PLACILLA (revisión 1)</b> Código: PPM-CEN024-2021-CC-DCO-0	
	miércoles 08 septiembre 2021	
Mandante	Revisión 1	Proveedor

## ÍNDICE



<b>1. RESUMEN EJECUTIVO .....</b>	<b>1</b>
<b>2. OBJETO DE LA PRUEBA.....</b>	<b>3</b>
<b>3. DESCRIPCIÓN TÉCNICA DE LOS EQUIPOS PRINCIPALES. ....</b>	<b>4</b>
3.1. MOTOR:.....	4
3.2. GENERADOR ELÉCTRICO:.....	5
<b>4. DESCRIPCIÓN DE LA PRUEBA. ....</b>	<b>6</b>
<b>5. INFORMACIÓN GENERAL ANTES Y DURANTE EL PROCESO DE LA PRUEBA.....</b>	<b>8</b>
<b>6. HOJAS DE CÁLCULO COMPLETAS DEL ENSAYO.....</b>	<b>10</b>
6.1. CÁLCULO DE POTENCIA MÁXIMA BRUTA CORREGIDA UNIDAD N°2 .....	10
6.2. CÁLCULO DE POTENCIA NETA CORREGIDA UNIDAD N°2.....	14
6.3. CÁLCULO DE POTENCIA MÁXIMA BRUTA CORREGIDA UNIDAD N°1 .....	15
6.4. CÁLCULO DE POTENCIA NETA CORREGIDA UNIDAD N°1.....	19
6.5. RESUMEN DE CÁLCULOS DE POTENCIA OBTENIDOS .....	20
<b>ANEXOS A (CURVA DE CORRECCIÓN).....</b>	<b>22</b>
A.1 CURVA DE CORRECCIÓN POR FACTOR DE POTENCIA.....	23
<b>ANEXO B (CERTIFICADOS DE CALIBRACIÓN DE MEDIDORES DE ENERGÍA).....</b>	<b>24</b>
B.1 CERTIFICADO DE CALIBRACIÓN DEL MEDIDOR DE FACTURACIÓN .....	25
B.2 CERTIFICADO DE CALIBRACIÓN DEL MEDIDOR DE ENERGÍA CONECTADO A LOS BORNES DEL GENERADOR DE LA UNIDAD N°2 .....	26
<b>ANEXO C (ESPECIFICACIONES TÉCNICAS DE LA UNIDAD N°2) .....</b>	<b>27</b>
C.1 ESPECIFICACIONES-TECNICAS-MODELO-QSK60 .....	28
C.2 DATA-SHEET-FR0628300-QSK-60 .....	31
C.3 SENSORES MOTOR QSK 60 CUMMINS.....	34

Realiza	Francisco Gorigoitia Acuña	Revisa	Patricio Febre Cisternas	Aprueba	Coordinador Eléctrico Nacional
Cargo	Ingeniero de Proyectos	Cargo	Experto Técnico	Cargo	
Firma		Firma		Firma	
Fecha	08/09/2021	Fecha	08/09/2021	Fecha	08/09/2021

	<b>INFORME TÉCNICO DE LA PRUEBA: “POTENCIA MÁXIMA” CENTRAL PLACILLA (revisión 1)</b> Código: PPM-CEN024-2021-CC-DCO-0	
	miércoles 08 septiembre 2021	
Mandante	Revisión 1	Proveedor

<b>ANEXO D (UNILINEAL ELÉCTRICO DE LA UNIDAD)</b> .....	<b>36</b>
<b>ANEXO E (CERTIFICADOS DE COMBUSTIBLE)</b> .....	<b>38</b>
E.1 INFORME DE ANALISIS Y REPORTE DE MUESTREO COMBUSTIBLE DIÉSEL .....	39
E.2 REGISTRO FOTOGRÁFICO DE LA TOMA DE MUESTRA DURANTE LA PRUEBA.....	42
<b>ANEXO F (REGISTRO DE MEDICIONES AMBIENTALES DURANTE LA PRUEBA)</b> .....	<b>44</b>
F.1 REGISTRO DE MEDICIONES DE HUMEDAD RELATIVA .....	45
F.2 REGISTRO DE MEDICIONES DE PRESIÓN ATMOSFÉRICA.....	93
F.3 REGISTRO DE MEDICIONES DE TEMPERATURA AMBIENTE .....	141
<b>ANEXO G (REGISTRO DE MEDIDORES DE ENERGÍA)</b> .....	<b>188</b>
G.1 REGISTRO DE POTENCIA EN MEDIDOR DE FACTURACIÓN .....	189
G.2 RESPALDO FOTOGRÁFICO DE LAS MEDICIONES DE POTENCIA EN EL MEDIDOR DE FACTURACIÓN .....	190
G.3 REGISTRO DE POTENCIA EN MEDIDOR CONECTADO A LOS BORNES DEL GENERADOR DE LA UNIDAD N°2.....	195
<b>ANEXO H (REGISTRO DE MEDICIONES DE LOS MOTORES)</b> .....	<b>316</b>
H.1 RESGISTRO DE MEDICIONES DEL MOTOR DE LA UNIDAD 1 .....	317
H.2 RESGISTRO DE MEDICIONES DEL MOTOR DE LA UNIDAD 2 .....	347
<b>ANEXO I (ACTA DE PRUEBA)</b> .....	<b>379</b>

Realiza	Francisco Gorigoitia Acuña	Revisa	Patricio Febre Cisternas	Aprueba	Coordinador Eléctrico Nacional
Cargo	Ingeniero de Proyectos	Cargo	Experto Técnico	Cargo	
Firma		Firma		Firma	
Fecha	08/09/2021	Fecha	08/09/2021	Fecha	08/09/2021

	<b>INFORME TÉCNICO DE LA PRUEBA: “POTENCIA MÁXIMA” CENTRAL PLACILLA (revisión 1)</b> Código: PPM-CEN024-2021-CC-DCO-0	
	miércoles 08 septiembre 2021	
Mandante	Revisión 1	Proveedor

## 1. RESUMEN EJECUTIVO

La empresa IMEE es invitada a participar al Proceso de Contratación para las Pruebas de Potencia Máxima de las Unidades El Totoral, Las Vegas, Linares Norte, Placilla, Quintay, San Gregorio y Concón Código: PPM-CEN024-2021-CC-DCO-0 (propiedad de TECNORED), adjudicando el 18 de mayo 2021 el presente servicio, liderado por el experto técnico Patricio Javier Febre Cisternas.

El presente informe describe los resultados de la Prueba de Potencia Máxima de la Central Placilla, ubicada en el sector de Placilla, comuna de Valparaíso, Región de Valparaíso, Chile. Por lo tanto, la empresa IMEE dispone de un Experto Técnico, el cuál supervisa la prueba en base a lo establecido en el protocolo de pruebas, y siguiendo además las indicaciones del Anexo Técnico: Pruebas de Potencia Máxima en Unidades Generadoras, emitido por el Coordinador Eléctrico Nacional.

La Central Placilla tiene una potencia bruta máxima de 3.200 kW (3,2 MW), según la información técnica enviada por el coordinado, la cual cuenta con tres unidades (conjunto motor Diésel – generador eléctrico). En la tabla 1 se describen datos generales de las tres unidades:



Unidad	Marca	Modelo	N° Serie Equipo	Target Potencia Prueba (KW)
U1	Cummins	QSK60-G3	L070136593	1.200
U2	Cummins	QSK60-G3	K070133527	1.200
U3	Cummins	QST30-G4	G070087303	800

Tabla 1: Datos generales de las unidades de Central Placilla.

La prueba de potencia máxima se realiza el día jueves 24 de junio 2021 sólo en las unidades N°1 y N°2 de Central Placilla, por encontrarse la unidad N°3 en falla, según lo establecido en la minuta N°270521 realizada el 27 mayo 2021. En relación a la toma de datos, se realiza solo a la unidad N°2, ya que vasta ensayar una cantidad de unidades no inferior al 30% del universo de cada tipo de motor, esto se estableció en el documento enviado por el Coordinador, denominado “PPM-CEN024-2021-CC-DCO-0

1

Realiza	Francisco Gorigoitia Acuña	Revisa	Patricio Febre Cisternas	Aprueba	Coordinador Eléctrico Nacional
Cargo	Ingeniero de Proyectos	Cargo	Experto Técnico	Cargo	
Firma		Firma		Firma	
Fecha	08/09/2021	Fecha	08/09/2021	Fecha	08/09/2021

	<b>INFORME TÉCNICO DE LA PRUEBA: “POTENCIA MÁXIMA” CENTRAL PLACILLA (revisión 1)</b> Código: PPM-CEN024-2021-CC-DCO-0	
	miércoles 08 septiembre 2021	
Mandante	Revisión 1	Proveedor

Respuestas a Consultas Pruebas PMax y CEN IMEE”. Además, se mide la potencia total de la planta con las dos unidades generando al mismo tiempo.

A las 08:45 hrs comienza la reunión online, mediante el software microsoft teams, para dar inicio a la etapa de estabilización y coordinaciones previas a la prueba. Una vez transcurrida una hora y 45 minutos (10:30 hrs) se da inicio a la prueba para comenzar con la toma de datos y seguimiento de la prueba por parte del Experto Técnico.

Durante las cinco horas de duración de la prueba se mantuvo una potencia activa bruta estable alrededor de los 1.200 kW (1,2 MW) para la unidad N°2 (valor obtenido del medidor de energía conectado a los bornes del generador). Durante ese mismo período de tiempo se mantuvo potencia activa bruta estable alrededor de los 2.400 kW (2,4 MW) para las dos unidades generando al mismo tiempo (valores obtenidos del medidor de facturación de la Central Placilla).



Se obtiene de la prueba los siguientes resultados (ver tabla 2) de potencia máxima bruta y neta para la Central Placilla (en la sección 6.5 del presente informe se desglosa el resumen para la unidad N°1, N°2):

Símbolo de Variable	Descripción Variable	Valor [kW]
$P_{max\ Central\ Placilla}$	Potencia máxima bruta medida	2.387
$P_{max\ corregida\ Central\ Placilla}$	Potencia máxima bruta corregida	2.373
$P_{neta\ Central\ Placilla}$	Potencia máxima neta medida	2.387
$P_{neta\ corregida\ Central\ Placilla}$	Potencia máxima neta corregida	2.373

Tabla 2: Resultados obtenidos de la prueba de potencia máxima para la Central Placilla.

2

Realiza	Francisco Gorigoitia Acuña	Revisa	Patricio Febre Cisternas	Aprueba	Coordinador Eléctrico Nacional
Cargo	Ingeniero de Proyectos	Cargo	Experto Técnico	Cargo	
Firma		Firma		Firma	
Fecha	08/09/2021	Fecha	08/09/2021	Fecha	08/09/2021

	<b>INFORME TÉCNICO DE LA PRUEBA: “POTENCIA MÁXIMA” CENTRAL PLACILLA (revisión 1)</b> Código: PPM-CEN024-2021-CC-DCO-0	
	miércoles 08 septiembre 2021	
Mandante	Revisión 1	Proveedor

## 2. OBJETO DE LA PRUEBA



La prueba a realizar en la unidad N°2 de Central Placilla ubicada en el sector de Placilla de la comuna de Valparaíso, Región de Valparaíso, Chile, tiene como objetivo determinar el valor de la máxima potencia activa bruta, solicitada por el Coordinador Eléctrico Nacional, que sea sostenible durante al menos 5 horas, bajo las exigencias medioambientales vigentes al momento de la verificación. (*definido en el artículo 28, anexo técnico Pruebas de Potencia Máxima en Unidades Generadoras*), y en conformidad a lo estipulado en el protocolo de prueba, anexo técnico (“Pruebas de Potencia Máxima en Unidades Generadoras”), de la Norma Técnica de Seguridad y Calidad de Servicio.

En relación a lo anterior, el valor obtenido durante la prueba debe ser informado mediante el presente informe técnico al Coordinador Eléctrico Nacional, y conforme a lo establecido en el artículo 22 del anexo técnico. Además, el experto técnico adjunta al presente informe el acta de la prueba.

Una vez aprobado el presente informe, este será publicado en el sitio web del Coordinador. Conforme resolución de la CNE, las empresas generadoras deberán validar el valor de potencia máxima de sus unidades en conformidad a las disposiciones del anexo técnico.

3

Realiza	Francisco Gorigoitia Acuña	Revisa	Patricio Febre Cisternas	Aprueba	Coordinador Eléctrico Nacional
Cargo	Ingeniero de Proyectos	Cargo	Experto Técnico	Cargo	
Firma		Firma		Firma	
Fecha	08/09/2021	Fecha	08/09/2021	Fecha	08/09/2021

	<b>INFORME TÉCNICO DE LA PRUEBA: “POTENCIA MÁXIMA” CENTRAL PLACILLA (revisión 1)</b> Código: PPM-CEN024-2021-CC-DCO-0	
	miércoles 08 septiembre 2021	
Mandante	Revisión 1	Proveedor

### 3. DESCRIPCIÓN TÉCNICA DE LOS EQUIPOS PRINCIPALES.

La presente sección indica una descripción general de los equipos principales involucrados en la prueba y los parámetros técnicos de los mismos:

#### 3.1. MOTOR:



La Central Placilla tiene 2 unidades de la misma marca y modelo de motor diésel (unidad N°1 y N°2), con las siguientes especificaciones técnicas (Ver tabla 3):

Ítem	Descripción del parámetro	Valores de los parámetros
1	Fabricante	CUMMINS ENGINE CO
2	Modelo	QSK60-G3
3	Procedencia	Reino Unido
4	N° de cilindros	16 en V
5	Desplazamiento	30,5 litros
6	Aspiración	Turbo cargado aftercooled
7	Ciclos	4 tiempos
8	Potencia ISO std	1304 kWm @ 1.500 [rpm], trabajo continuo.
9	Consumo de combustible a 80% de la carga	283 lts/hr. Diésel N°2.
10	Refrigeración	Radiador para trabajo pesado montado en la base.
12	Diámetro y carrera	6,25" (159 mm) X 7,48" (190 mm).

Tabla 3: Parámetros técnicos del motor.

4

Realiza	Francisco Gorigoitia Acuña	Revisa	Patricio Febre Cisternas	Aprueba	Coordinador Eléctrico Nacional
Cargo	Ingeniero de Proyectos	Cargo	Experto Técnico	Cargo	
Firma		Firma		Firma	
Fecha	08/09/2021	Fecha	08/09/2021	Fecha	08/09/2021

	<b>INFORME TÉCNICO DE LA PRUEBA: “POTENCIA MÁXIMA” CENTRAL PLACILLA (revisión 1)</b> Código: PPM-CEN024-2021-CC-DCO-0	
	miércoles 08 septiembre 2021	
Mandante	Revisión 1	Proveedor

### 3.2. GENERADOR ELÉCTRICO:

La Central Placilla tiene 2 unidades de la misma marca y modelo del generador eléctrico (unidad N°1 y N°2), con las siguientes especificaciones técnicas (Ver tabla 4):



Ítem	Descripción del parámetro	Valores de los parámetros
1	Fabricante	NEWAGE STAMFORD
2	Tipo	Sin escobillas trifásico con excitación PMG
3	Voltaje	230/400 [V] con neutro accesible
4	Frecuencias	50 Hz, 4 polos
5	Factor de Potencia	0,8 inductivo
6	Aislación	Clase H
7	Regulador de voltaje	Incorporado en el PCC 0,5%
8	Refrigeración	Aire Forzado, autoventilado
9	N° de rodamientos.	Uno prelubricado.

Tabla 4: Parámetros técnicos del generador.

5

Realiza	Francisco Gorigoitia Acuña	Revisa	Patricio Febre Cisternas	Aprueba	Coordinador Eléctrico Nacional
Cargo	Ingeniero de Proyectos	Cargo	Experto Técnico	Cargo	
Firma		Firma		Firma	
Fecha	08/09/2021	Fecha	08/09/2021	Fecha	08/09/2021



	<b>INFORME TÉCNICO DE LA PRUEBA: “POTENCIA MÁXIMA” CENTRAL PLACILLA (revisión 1)</b> Código: PPM-CEN024-2021-CC-DCO-0	
	miércoles 08 septiembre 2021	
Mandante	Revisión 1	Proveedor

#### 4. DESCRIPCIÓN DE LA PRUEBA.

La prueba se ejecuta el día jueves 24 junio 2020 desde las 10:30 hasta 15:30 hrs, en modo teledirigido, la cual se cumple el periodo de 5 horas continuas conforme a lo requerido en el Anexo técnico de Pruebas de Potencia Máxima. A continuación, se describen las diferentes etapas durante la prueba:

4.1. A las 08:45 hrs los participantes de la prueba se conectan vía Microsoft Teams. En el acta de la prueba, adjunta en la sección anexos del presente informe, se describe el nombre, email, cargo, empresa u organización a la que pertenece cada participante.

4.2. Durante las 08:45 a 10:30 hrs se realizan los siguientes trabajos:



4.2.1. Se detecta que el medidor de facturación se encuentra desfasado por 4 horas adicionales. Es decir, a las 09:08 am en el medidor de facturación marca las 13:08. Para lograr una verificación se posiciona un smartphone físicamente con la hora del SHOA y la hora del medidor de facturación (ver Fig. 1).



Fig. 1: Toma de dato en el medidor de facturación de central Placilla.

6



Realiza	Francisco Gorigoitia Acuña	Revisa	Patricio Febre Cisternas	Aprueba	Coordinador Eléctrico Nacional
Cargo	Ingeniero de Proyectos	Cargo	Experto Técnico	Cargo	
Firma		Firma		Firma	
Fecha	08/09/2021	Fecha	08/09/2021	Fecha	08/09/2021

	<b>INFORME TÉCNICO DE LA PRUEBA: “POTENCIA MÁXIMA” CENTRAL PLACILLA (revisión 1)</b> Código: PPM-CEN024-2021-CC-DCO-0	
	miércoles 08 septiembre 2021	
Mandante	Revisión 1	Proveedor

- 4.2.2. Se visualizan las pantallas SCADA, de la temperatura ambiente, pantallas de Cummins, y medidor de facturación.
- 4.2.3. En el motor 2 (unidad 2) se encuentra el medidor de energía adicional.
- 4.2.4. Se verifica la estabilización de los parámetros operacionales de la Central antes de comenzar la prueba. Los dos motores de la unidad N°1 y N°2 se encuentran generando a 1200 [kW] antes de iniciar la prueba de manera estable.
- 4.2.5. Se ajusta el factor de potencia a 0,95.
- 4.2.6. Se confirman que durante este periodo todos los parámetros serán descargados vía software cada 5 minutos.
- 4.2.7. Se realiza por parte del Experto Técnico la revisión del check list establecido en el protocolo de prueba para la etapa de estabilización, en conjunto con los participantes del Coordinado y Coordinador.
- 4.2.8. El coordinador y experto técnico visualizan información por las cámaras y encuentran que es suficiente la información técnica para dar inicio a la prueba.
- 4.3. A las 10:30 hrs se da inicio a la prueba de Potencia Máxima en Central Placilla. Durante la prueba se establecen los siguientes consideraciones y acuerdos:
- 4.3.1. Las pruebas de Potencia Máxima y Consumo Específico Neto se realizan el mismo día, es por esto que se establece utilizar las muestras de la prueba de consumo específico neto como dato ya que es el mismo combustible obtenido del estanque principal de la central para las dos pruebas.
- 4.3.2. Se definen en forma tripartita (Coordinado – Experto Técnico - Coordinador) en donde el Coordinado entrega las mediciones del medidor de energía de facturación con una tasa de muestreo cada 15 minutos, realizando por parte del Coordinado un respaldo fotográfico cada 15 minutos como se muestra en la foto adjunta en el punto 4.2.1 del presente informe.

7

Realiza	Francisco Gorigoitia Acuña	Revisa	Patricio Febre Cisternas	Aprueba	Coordinador Eléctrico Nacional
Cargo	Ingeniero de Proyectos	Cargo	Experto Técnico	Cargo	
Firma		Firma		Firma	
Fecha	08/09/2021	Fecha	08/09/2021	Fecha	08/09/2021

	<b>INFORME TÉCNICO DE LA PRUEBA: “POTENCIA MÁXIMA” CENTRAL PLACILLA (revisión 1)</b> Código: PPM-CEN024-2021-CC-DCO-0	
	miércoles 08 septiembre 2021	
Mandante	Revisión 1	Proveedor

4.3.3. Se crea un grupo de whatsapp oficial con los participantes del Coordinado, Experto Técnico y Coordinador para compartir las fotos en tiempo real del medidor de facturación de energía con el formato descrito en el punto 4.2.1 del presente informe.

## 5. INFORMACIÓN GENERAL ANTES Y DURANTE EL PROCESO DE LA PRUEBA

5.1 El Coordinado envía los certificados de calibración de los siguientes medidores de energía:



Medidor	Marca	Modelo	N° Serie	Fecha de Calibración
Medidor de Facturación Central Placilla	Schneider Electric	P8600A4C0H5E0B0A	PT-0612A152-01	02/03/2021
Medidor de Energía conectado a los bornes del generador unidad N°2	Schneider Electric	M8650A4C0H5E1B0A-AA566	MW-1811A713-02	27/05/2021

Tabla 5: Identificación de los medidores de energía.

En el Anexo B se adjuntan los certificados de calibración de los medidores de energía.

8

Realiza	Francisco Gorigoitia Acuña	Revisa	Patricio Febre Cisternas	Aprueba	Coordinador Eléctrico Nacional
Cargo	Ingeniero de Proyectos	Cargo	Experto Técnico	Cargo	
Firma		Firma		Firma	
Fecha	08/09/2021	Fecha	08/09/2021	Fecha	08/09/2021

	<b>INFORME TÉCNICO DE LA PRUEBA: “POTENCIA MÁXIMA” CENTRAL PLACILLA (revisión 1)</b> Código: PPM-CEN024-2021-CC-DCO-0	
	miércoles 08 septiembre 2021	
Mandante	Revisión 1	Proveedor

5.2 A continuación, se muestra el resumen de los valores medidos y sus variaciones de la unidad N°2:



Ítem	Parámetro	Valores de Diseño	Unidad	Valor Promedio Medido	Variación porcentual del promedio con respecto al valor de diseño [%]
1	Potencia activa bruta medido en los bornes del generador.	1.211	[kW]	1193,72	1,42 %
2	Voltaje de generación	230 / 400	[V]	229,6 / 397,7	0,17% / 0,57%
3	Velocidad de rotación	1.500	[rpm]	1501,35	0,09%
4	Factor de potencia	0,8	[-]	0,95 (se ajusta para la prueba)	No aplica
5	Consumo Combustible	270	[l/h]	No Aplica	No aplica
6	Presión Atmosférica	100	[kPa]	1024,84 [mbar] = 102,48 [kPa] (ver detalle en anexo F, sección F.2)	2,48 [%]
7	Temperatura Ambiente	25	[°C]	13,86 (ver detalle en anexo F, sección F.1)	No aplica
8	Humedad Relativa	30	[%]	73,37 (ver detalle en anexo F, sección F.1)	No aplica
9	Altitud sobre el nivel del mar	110	[m]	355 metros sobre el nivel del mar obtenido de la ubicación de Central Placilla en Google Earth	No aplica

Tabla 6: Variación de valores durante la prueba.

En la tabla 6 se visualizan variaciones en los parámetros más relevantes no más del 3%, el cual está dentro de los rangos permisibles durante una prueba de potencia máxima.

9

Realiza	Francisco Gorigoitia Acuña	Revisa	Patricio Febre Cisternas	Aprueba	Coordinador Eléctrico Nacional
Cargo	Ingeniero de Proyectos	Cargo	Experto Técnico	Cargo	
Firma		Firma		Firma	
Fecha	08/09/2021	Fecha	08/09/2021	Fecha	08/09/2021

	<b>INFORME TÉCNICO DE LA PRUEBA: “POTENCIA MÁXIMA” CENTRAL PLACILLA (revisión 1)</b> Código: PPM-CEN024-2021-CC-DCO-0	
	miércoles 08 septiembre 2021	
Mandante	Revisión 1	Proveedor

## 6. HOJAS DE CÁLCULO COMPLETAS DEL ENSAYO.

En el presente informe se realiza el cálculo de las correcciones a la potencia máxima bruta y potencia máxima neta medida en base a lo establecido en el anexo técnico para Pruebas de Potencia Máxima.

### 6.1. CÁLCULO DE POTENCIA MÁXIMA BRUTA CORREGIDA UNIDAD N°2

En esta sección se presenta el cálculo de la potencia máxima bruta corregida de la unidad N°2 con respecto de la potencia máxima bruta medida en los bornes del generador del medidor provisorio de la unidad N°2 de Central Placilla.

En el artículo 34, letra d), del anexo técnico para Pruebas de Potencia Máxima se establece que las correcciones a la potencia de un motor de combustión interna se realizarán en base a las siguientes variables.

- 6.1.1 Corrección por presión barométrica o por altura m.s.n.m.
- 6.1.2 Corrección por temperatura de aire de aspiración.
- 6.1.3 Corrección por factor de potencia.
- 6.1.4 Corrección por humedad relativa.

Para las correcciones por presión barométrica, temperatura de aspiración y humedad relativa se realiza en base a lo definido en la Norma ISO 30461-2002.

Se define la fórmula de corrección de potencia para motores con turbocargador con la siguiente expresión:

$$P_{\text{corregida}} = \alpha \times P_{\text{medida}}$$



En donde  $\alpha$  se define como:

$$\alpha = k - 0,7 \times (1 - k) \times \left( \frac{1}{\eta_m} - 1 \right)$$

$\eta_m$ : Rendimiento mecánico.

10

Realiza	Francisco Gorigoitia Acuña	Revisa	Patricio Febre Cisternas	Aprueba	Coordinador Eléctrico Nacional
Cargo	Ingeniero de Proyectos	Cargo	Experto Técnico	Cargo	
Firma		Firma		Firma	
Fecha	08/09/2021	Fecha	08/09/2021	Fecha	08/09/2021

	<b>INFORME TÉCNICO DE LA PRUEBA: “POTENCIA MÁXIMA” CENTRAL PLACILLA (revisión 1)</b> Código: PPM-CEN024-2021-CC-DCO-0	
	miércoles 08 septiembre 2021	
Mandante	Revisión 1	Proveedor

En donde  $k$  se define como:

$$k = \left(\frac{P_x}{P_{ra}}\right)^m \times \left(\frac{T_{ra}}{T_x}\right)^n \times \left(\frac{T_{cra}}{T_{cx}}\right)^s$$

$P_x$ : Presión barométrica total del sitio.

$P_{ra}$ : Presión barométrica estándar o ISO.

$T_x$ : Temperatura ambiental total de sitio.

$T_{ra}$ : Temperatura ambiental estándar.

$T_{cx}$ : Temperatura del agua de enfriamiento del aire de carga, que sale del turbocompresor, en condiciones de sitio.



$T_{cra}$ : Temperatura del agua de enfriamiento del aire de carga, que sale del turbocompresor, en condiciones estándar.

En relación a las consideraciones del cálculo, no se realizará la corrección en base a las temperaturas del agua de enfriamiento del aire de carga, que sale del turbocompresor, por lo tanto, la expresión  $\left(\frac{T_{cra}}{T_{cx}}\right)^s$  no es considerada dentro de los cálculos que se describen en las siguientes páginas del presente informe.

También se considera la temperatura total de sitio equivalente a la temperatura ISO standard la cual es 25°C, porque esta temperatura se mide a la entrada del motor diésel y se considera que al tener un turbocompresor antes de entrar al compresor ingresa con una temperatura al motor cercana a los 25°C haciendo que la expresión  $\left(\frac{T_{ra}}{T_x}\right)^n \approx 1$ .

11

Realiza	Francisco Gorigoitia Acuña	Revisa	Patricio Febre Cisternas	Aprueba	Coordinador Eléctrico Nacional
Cargo	Ingeniero de Proyectos	Cargo	Experto Técnico	Cargo	
Firma		Firma		Firma	
Fecha	08/09/2021	Fecha	08/09/2021	Fecha	08/09/2021

	<b>INFORME TÉCNICO DE LA PRUEBA: “POTENCIA MÁXIMA” CENTRAL PLACILLA (revisión 1)</b> Código: PPM-CEN024-2021-CC-DCO-0	
	miércoles 08 septiembre 2021	
Mandante	Revisión 1	Proveedor

Para los valores de los exponentes m, n y s se obtienen de la siguiente tabla obtenida de la Norma ISO 30461.

Tipo de motor	Tipo de combustible	Condiciones	Referencia de fórmula	Factor a	Exponentes			
					m	n	s	
Motores diesel y de doble combustible, de encendido por compresión, operando con combustible líquido.	Diesel	Sin turbocargador	Potencia limitada por aire en exceso insuficiente	A	1	1	0,75	0
			Potencia limitada por razones térmicas	B	0	1	1	0
		Con turbocargador y sin refrigeración del aire de carga	Motores de cuatro tiempos de velocidad baja y media	C	0	0,7	2	0
			Con Turbocargador y refrigeración del aire de carga	D	0	0,7	1,2	1

Tabla 7: Valores numéricos para el ajuste o regulación de la potencia.

Por lo tanto, para el valor de k se obtiene lo siguiente:

$$k = \left( \frac{102,48 [kPa]}{100 [kPa]} \right)^{0,7} = (1,0248)^{0,7} = 1,0172$$

$$k \approx 1,02$$

Por lo tanto, para el valor de  $\alpha$  se obtiene lo siguiente:



$$\alpha = k - 0,7 \times (1 - k) \times \left( \frac{1}{\eta_m} - 1 \right) = 1,02 - \left( 0,7 \times (1 - 1,02) \times \left( \frac{1}{0,8} - 1 \right) \right) = 1,02 - (0,7 \times (-0,02) \times (0,25))$$

$$\alpha = 1,02 + 0,18$$

$$\alpha \approx 1,023$$

12

Realiza	Francisco Gorigoitia Acuña	Revisa	Patricio Febre Cisternas	Aprueba	Coordinador Eléctrico Nacional
Cargo	Ingeniero de Proyectos	Cargo	Experto Técnico	Cargo	
Firma		Firma		Firma	
Fecha	08/09/2021	Fecha	08/09/2021	Fecha	08/09/2021

	<b>INFORME TÉCNICO DE LA PRUEBA: “POTENCIA MÁXIMA” CENTRAL PLACILLA (revisión 1)</b> Código: PPM-CEN024-2021-CC-DCO-0	
	miércoles 08 septiembre 2021	
Mandante	Revisión 1	Proveedor

La norma ISO 30461-2002 recomienda en caso de no tener el valor del rendimiento mecánico  $\eta_m$  de parte del fabricante, se debe asumir  $\eta_m = 0,8$ .

Para las consideraciones anteriores se obtiene la potencia corregida:

$$P_{\text{corregida } 1} = \alpha \times P_{\text{max } U2} = 1,023 \times 1.259 \text{ [kW]}$$

$$P_{\text{corregida } 1} \approx 1.288 \text{ [kW]}$$

Con el valor de la potencia corregida N°1 se realiza la corrección por el factor de potencia en base a una curva validada por el coordinador de manera pública en el informe *denominado “Informe de Pruebas de Potencia Máxima Central Térmica Chiloé”* con fecha del 13 julio 2021.

La consideración que se realiza para seleccionar esta curva (ver curva de corrección en anexo A) es que fue aplicada a una unidad de similares características motor diésel Caterpillar PRIME modelo 3512 y un generador con capacidad de entregar una potencia bruta aproximada de hasta 1200 [kW].



Por lo tanto, de la curva anteriormente mencionada se obtiene:

$$P_{\text{max corregida } U2} = FC \times P_{\text{corregida } 1} = 0,972 \times 1.288 \text{ [kW]}$$

$$P_{\text{max corregida } U2} \approx 1.252 \text{ [kW]}$$

Realiza	Francisco Gorigoitia Acuña	Revisa	Patricio Febre Cisternas	Aprueba	Coordinador Eléctrico Nacional
Cargo	Ingeniero de Proyectos	Cargo	Experto Técnico	Cargo	
Firma		Firma		Firma	
Fecha	08/09/2021	Fecha	08/09/2021	Fecha	08/09/2021



	<b>INFORME TÉCNICO DE LA PRUEBA: “POTENCIA MÁXIMA” CENTRAL PLACILLA (revisión 1)</b> Código: PPM-CEN024-2021-CC-DCO-0	
	miércoles 08 septiembre 2021	
Mandante	Revisión 1	Proveedor

### 6.2. CÁLCULO DE POTENCIA NETA CORREGIDA UNIDAD N°2

En resumen, con la información entregada por el Coordinado se obtienen los siguientes valores (ver anexo G):

Símbolo de Variable	Descripción Variable	Valor [kW]
$P_{\max U2}$	Potencia máxima bruta medida en unidad N°2.	1.259
$P_{\max \text{ corregida } U2}$	Potencia máxima bruta corregida en unidad N°2.	1.253
$P_{\text{Consumo } U2}$	Consumos propios medidos promedio	0



Para el cálculo de la Potencia Neta resulta lo siguiente:

$$P_{\text{neto } U2} = P_{\max U2} - P_{\text{consumo } U2} = P_{\max U2} = 1.259 \text{ [kW]}$$

Para el cálculo de la Potencia Neta corregida resulta lo siguiente:

$$P_{\text{neto corregida } U2} = P_{\max \text{ corregida } U2} - P_{\text{consumo } 1} = P_{\max \text{ corregida } U2} = 1.253 \text{ [kW]}$$

Realiza	Francisco Gorigoitia Acuña	Revisa	Patricio Febre Cisternas	Aprueba	Coordinador Eléctrico Nacional
Cargo	Ingeniero de Proyectos	Cargo	Experto Técnico	Cargo	
Firma		Firma		Firma	
Fecha	08/09/2021	Fecha	08/09/2021	Fecha	08/09/2021

	<b>INFORME TÉCNICO DE LA PRUEBA: “POTENCIA MÁXIMA” CENTRAL PLACILLA (revisión 1)</b> Código: PPM-CEN024-2021-CC-DCO-0	
	miércoles 08 septiembre 2021	
Mandante	Revisión 1	Proveedor

### 6.3. CÁLCULO DE POTENCIA MÁXIMA BRUTA CORREGIDA UNIDAD N°1

En esta sección se presenta el cálculo de la potencia máxima bruta corregida de la unidad N°1 de Central Placilla.

Para definir la metodología de cálculo se obtiene la diferencia porcentual entre el valor de potencia máxima medido en la unidad N°2 y el valor de la potencia máxima bruta de la unidad N°1, obtenida por la diferencia entre el valor medido en el medidor de facturación y el instalado provisoriamente en los bornes de generador de la unidad N°2 específicamente para esta prueba.

Por lo tanto, el valor de la potencia máxima bruta de la unidad N°1 es:

$$P_{max U1} = P_{medidor facturación} - P_{max U2} = 2.387 - 1.259 = 1.128 [kW]$$

Y la diferencia porcentual entre la unidad N°1 y N°2 es:

$$\% \Delta P = \frac{P_{max U2} - P_{max U1}}{P_{max U2}} \times 100\% = \frac{1.259 - 1.128}{1.259} \times 100\% = 10,4 \%$$

Al existir una diferencia porcentual mayor al 3% se calcula la potencia máxima corregida para la unidad N°1 en base al procedimiento descrito en la sección 6.1 del presente informe.



En el artículo 34, letra d), del anexo técnico para Pruebas de Potencia Máxima se establece que las correcciones a la potencia de un motor de combustión interna se realizarán en base a las siguientes variables.

- 6.1.1 Corrección por presión barométrica o por altura m.s.n.m.
- 6.1.2 Corrección por temperatura de aire de aspiración.
- 6.1.3 Corrección por factor de potencia.
- 6.1.4 Corrección por humedad relativa.

Para las correcciones por presión barométrica, temperatura de aspiración y humedad relativa se realiza en base a lo definido en la Norma ISO 30461-2002.

15

Realiza	Francisco Gorigoitia Acuña	Revisa	Patricio Febre Cisternas	Aprueba	Coordinador Eléctrico Nacional
Cargo	Ingeniero de Proyectos	Cargo	Experto Técnico	Cargo	
Firma		Firma		Firma	
Fecha	08/09/2021	Fecha	08/09/2021	Fecha	08/09/2021

	<b>INFORME TÉCNICO DE LA PRUEBA: “POTENCIA MÁXIMA” CENTRAL PLACILLA (revisión 1)</b> Código: PPM-CEN024-2021-CC-DCO-0	
	miércoles 08 septiembre 2021	
Mandante	Revisión 1	Proveedor

Se define la fórmula de corrección de potencia para motores con turbocargador con la siguiente expresión:

$$P_{\text{corregida}} = \alpha \times P_{\text{medida}}$$

En donde  $\alpha$  se define como:

$$\alpha = k - 0,7 \times (1 - k) \times \left( \frac{1}{\eta_m} - 1 \right)$$

$\eta_m$ : Rendimiento mecánico.

En donde  $k$  se define como:

$$k = \left( \frac{P_x}{P_{ra}} \right)^m \times \left( \frac{T_{ra}}{T_x} \right)^n \times \left( \frac{T_{cra}}{T_{cx}} \right)^s$$

$P_x$ : Presión barométrica total del sitio.

$P_{ra}$ : Presión barométrica estándar o ISO.

$T_x$ : Temperatura ambiental total de sitio.

$T_{ra}$ : Temperatura ambiental estándar.



$T_{cx}$ : Temperatura del agua de enfriamiento del aire de carga, que sale del turbocompresor, en condiciones de sitio.

$T_{cra}$ : Temperatura del agua de enfriamiento del aire de carga, que sale del turbocompresor, en condiciones estándar.

En relación a las consideraciones del cálculo, no se realizará la corrección en base a las temperaturas del agua de enfriamiento del aire de carga, que sale del turbocompresor, por lo tanto, la expresión  $\left( \frac{T_{cra}}{T_{cx}} \right)^s$  no es considerada dentro de los cálculos que se describen en las siguientes páginas del presente informe.

16

Realiza	Francisco Gorigoitia Acuña	Revisa	Patricio Febre Cisternas	Aprueba	Coordinador Eléctrico Nacional
Cargo	Ingeniero de Proyectos	Cargo	Experto Técnico	Cargo	
Firma		Firma		Firma	
Fecha	08/09/2021	Fecha	08/09/2021	Fecha	08/09/2021

	<b>INFORME TÉCNICO DE LA PRUEBA: “POTENCIA MÁXIMA” CENTRAL PLACILLA (revisión 1)</b> Código: PPM-CEN024-2021-CC-DCO-0	
	miércoles 08 septiembre 2021	
Mandante	Revisión 1	Proveedor

También se considera la temperatura total de sitio equivalente a la temperatura ISO standard la cual es 25°C, porque esta temperatura se mide a la entrada del motor diésel y se considera que al tener un turbocompresor antes de entrar al compresor ingresa con una temperatura al motor cercana a los 25°C haciendo que la expresión  $\left(\frac{T_{ra}}{T_x}\right)^n \approx 1$ .

Para los valores de los exponentes m, n y s se obtienen de la siguiente tabla obtenida de la Norma ISO 30461.

Tipo de motor	Tipo de combustible	Condiciones		Referencia de fórmula	Factor a	Exponentes		
						m	n	s
Motores diésel y de doble combustible, de encendido por compresión, operando con combustible líquido.	Diésel	Sin turbocargador	Potencia limitada por aire en exceso insuficiente	A	1	1	0,75	0
			Potencia limitada por razones térmicas	B	0	1	1	0
		Con turbocargador y sin refrigeración del aire de carga	Motores de cuatro tiempos de velocidad baja y media	C	0	0,7	2	0
				D	0	0,7	1,2	1

Tabla 7: Valores numéricos para el ajuste o regulación de la potencia.



Por lo tanto, para el valor de k se obtiene lo siguiente:

$$k = \left(\frac{102,48[kPa]}{100[kPa]}\right)^{0,7} = (1,0248)^{0,7} = 1,0172$$

$$k \approx 1,02$$

17

Realiza	Francisco Gorigoitia Acuña	Revisa	Patricio Febre Cisternas	Aprueba	Coordinador Eléctrico Nacional
Cargo	Ingeniero de Proyectos	Cargo	Experto Técnico	Cargo	
Firma		Firma		Firma	
Fecha	08/09/2021	Fecha	08/09/2021	Fecha	08/09/2021

	<b>INFORME TÉCNICO DE LA PRUEBA: “POTENCIA MÁXIMA” CENTRAL PLACILLA (revisión 1)</b> Código: PPM-CEN024-2021-CC-DCO-0	
	miércoles 08 septiembre 2021	
Mandante	Revisión 1	Proveedor

Por lo tanto, para el valor de  $\alpha$  se obtiene lo siguiente:

$$\alpha = k - 0,7 \times (1 - k) \times \left( \frac{1}{\eta_m} - 1 \right) = 1,02 - \left( 0,7 \times (1 - 1,02) \times \left( \frac{1}{0,8} - 1 \right) \right) = 1,02 - (0,7 \times (-0,02) \times (0,25))$$

$$\alpha = 1,02 + 0,18$$

$$\alpha \approx 1,023$$

La norma ISO 30461-2002 recomienda en caso de no tener el valor del rendimiento mecánico  $\eta_m$  de parte del fabricante, se debe asumir  $\eta_m = 0,8$ .

Para las consideraciones anteriores se obtiene la potencia corregida:

$$P_{\text{corregida } 2} = \alpha \times P_{\text{max}U1} = 1,023 \times 1.128 \text{ [kW]}$$

$$P_{\text{corregida } 2} \approx 1.154 \text{ [kW]}$$

Con el valor de la potencia corregida N°2 se realiza la corrección por el factor de potencia en base a una curva validada por el coordinador de manera pública en el informe *denominado “Informe de Pruebas de Potencia Máxima Central Térmica Chiloé”* con fecha del 13 julio 2021.

La consideración que se realiza para seleccionar esta curva (ver curva de corrección en anexo A) es que fue aplicada a una unidad de similares características motor diésel Caterpillar PRIME modelo 3512 y un generador con capacidad de entregar una potencia bruta aproximada de hasta 1200 [kW].



Por lo tanto, de la curva anteriormente mencionada se obtiene:

$$P_{\text{max corregida } U1} = FC \times P_{\text{corregida } 2} = 0,971 \times 1.154 \text{ [kW]}$$

$$P_{\text{max corregida } U1} \approx 1.120 \text{ [kW]}$$

18

Realiza	Francisco Gorigoitia Acuña	Revisa	Patricio Febre Cisternas	Aprueba	Coordinador Eléctrico Nacional
Cargo	Ingeniero de Proyectos	Cargo	Experto Técnico	Cargo	
Firma		Firma		Firma	
Fecha	08/09/2021	Fecha	08/09/2021	Fecha	08/09/2021

	<b>INFORME TÉCNICO DE LA PRUEBA: “POTENCIA MÁXIMA” CENTRAL PLACILLA (revisión 1)</b> Código: PPM-CEN024-2021-CC-DCO-0	
	miércoles 08 septiembre 2021	
Mandante	Revisión 1	Proveedor

#### 6.4. CÁLCULO DE POTENCIA NETA CORREGIDA UNIDAD N°1

En resumen, se obtienen los siguientes valores para la unidad N°1:

Símbolo de Variable	Descripción Variable	Valor [kW]
$P_{\max U1}$	Potencia máxima bruta en unidad N°1.	1.128
$P_{\max \text{ corregida } U1}$	Potencia máxima bruta corregida en unidad N°1.	1.120
$P_{\text{Consumo } U1}$	Consumos propios medidos promedio	0



Para el cálculo de la Potencia Neta resulta lo siguiente:

$$P_{\text{neto } U1} = P_{\max U1} - P_{\text{consumo } U1} = P_{\max U1} = 1.128 \text{ [kW]}$$

Para el cálculo de la Potencia Neta corregida resulta lo siguiente:

$$P_{\text{neto corregida } U1} = P_{\max \text{ corregida } U1} - P_{\text{consumo } U1} = P_{\max \text{ corregida } U1} = 1.120 \text{ [kW]}$$

Realiza	Francisco Gorigoitia Acuña	Revisa	Patricio Febre Cisternas	Aprueba	Coordinador Eléctrico Nacional
Cargo	Ingeniero de Proyectos	Cargo	Experto Técnico	Cargo	
Firma		Firma		Firma	
Fecha	08/09/2021	Fecha	08/09/2021	Fecha	08/09/2021

	<b>INFORME TÉCNICO DE LA PRUEBA: “POTENCIA MÁXIMA” CENTRAL PLACILLA (revisión 1)</b> Código: PPM-CEN024-2021-CC-DCO-0	
	miércoles 08 septiembre 2021	
Mandante	Revisión 1	Proveedor

### 6.5. RESUMEN DE CÁLCULOS DE POTENCIA OBTENIDOS

A continuación, se muestra el resumen de los de datos medidos y calculados como objetivo de la prueba de potencia máxima para Central Placilla propiedad de TECNORED.

En relación a la prueba de potencia máxima realizada a la unidad N°2:



Símbolo de Variable	Descripción Variable	Valor [kW]
$P_{\max U2}$	Potencia máxima bruta medida	1.259
$P_{\max \text{ corregida } U2}$	Potencia máxima bruta corregida	1.253
$P_{\text{ neta } U2}$	Potencia máxima neta medida	1.259
$P_{\text{ neta } \text{ corregida } U2}$	Potencia máxima neta corregida	1.253

Para la unidad N°1:

Símbolo de Variable	Descripción Variable	Valor [kW]
$P_{\max U1}$	Potencia máxima bruta medida	1.128
$P_{\max \text{ corregida } U1}$	Potencia máxima bruta corregida	1.120
$P_{\text{ neta } U1}$	Potencia máxima neta medida	1.128
$P_{\text{ neta } \text{ corregida } U1}$	Potencia máxima neta corregida	1.120

20

Realiza	Francisco Gorigoitia Acuña	Revisa	Patricio Febre Cisternas	Aprueba	Coordinador Eléctrico Nacional
Cargo	Ingeniero de Proyectos	Cargo	Experto Técnico	Cargo	
Firma		Firma		Firma	
Fecha	08/09/2021	Fecha	08/09/2021	Fecha	08/09/2021

	<b>INFORME TÉCNICO DE LA PRUEBA: “POTENCIA MÁXIMA” CENTRAL PLACILLA (revisión 1)</b> Código: PPM-CEN024-2021-CC-DCO-0	
	miércoles 08 septiembre 2021	
Mandante	Revisión 1	Proveedor

Para Central Placilla (Unidad N°1 y N°2 operando simultáneamente a máxima carga):



Símbolo de Variable	Descripción Variable	Valor [kW]
$P_{\max \text{ Central Placilla}}$	Potencia máxima bruta medida	2.387
$P_{\max \text{ corregida Central Placilla}}$	Potencia máxima bruta corregida	2.373
$P_{\text{neta Central Placilla}}$	Potencia máxima neta medida	2.387
$P_{\text{neta corregida Central Placilla}}$	Potencia máxima neta corregida	2.373

21

Realiza	Francisco Gorigoitia Acuña	Revisa	Patricio Febre Cisternas	Aprueba	Coordinador Eléctrico Nacional
Cargo	Ingeniero de Proyectos	Cargo	Experto Técnico	Cargo	
Firma		Firma		Firma	
Fecha	08/09/2021	Fecha	08/09/2021	Fecha	08/09/2021

INGENIERÍA, MANTENIMIENTO Y EFICIENCIA ENERGÉTICA SPA, RUT: 76.696.552-0, Dirección: Errázuriz #1178, Oficina N° 75, Valparaíso, E-mail: [PATRICIO.FEBRE@IMEE.CL](mailto:PATRICIO.FEBRE@IMEE.CL), Contacto: +56-9-93279529, Sitio Web: [WWW.IMEE.CL](http://WWW.IMEE.CL).



	<b>INFORME TÉCNICO DE LA PRUEBA: “POTENCIA MÁXIMA” CENTRAL PLACILLA (revisión 1)</b> Código: PPM-CEN024-2021-CC-DCO-0	
	miércoles 08 septiembre 2021	
Mandante	Revisión 1	Proveedor

## ANEXOS A (CURVA DE CORRECCIÓN)



22

Realiza	Francisco Gorigoitia Acuña	Revisa	Patricio Febre Cisternas	Aprueba	Coordinador Eléctrico Nacional
Cargo	Ingeniero de Proyectos	Cargo	Experto Técnico	Cargo	
Firma		Firma		Firma	
Fecha	08/09/2021	Fecha	08/09/2021	Fecha	08/09/2021

INGENIERÍA, MANTENIMIENTO Y EFICIENCIA ENERGÉTICA SPA, RUT: 76.696.552-0, Dirección: Errázuriz #1178, Oficina N° 75, Valparaíso, E-mail: [PATRICIO.FEBRE@IMEE.CL](mailto:PATRICIO.FEBRE@IMEE.CL), Contacto: +56-9-93279529, Sitio Web: [WWW.IMEE.CL](http://WWW.IMEE.CL).

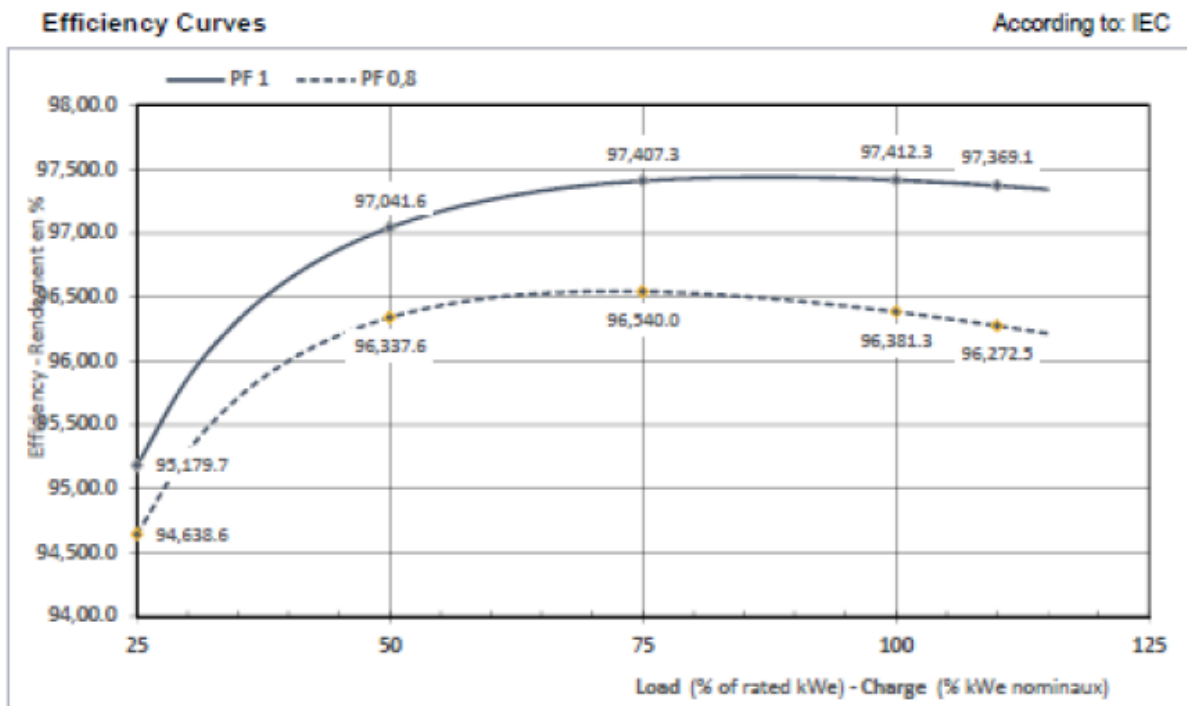
## A.1 CURVA DE CORRECCIÓN POR FACTOR DE POTENCIA



	<b>INFORME TÉCNICO DE LA PRUEBA: “POTENCIA MÁXIMA” CENTRAL PLACILLA (revisión 1)</b> Código: PPM-CEN024-2021-CC-DCO-0	
	miércoles 08 septiembre 2021	
Mandante	Revisión 1	Proveedor

## ANEXO B (CERTIFICADOS DE CALIBRACIÓN DE MEDIDORES DE ENERGÍA)

24

Realiza	Francisco Gorigoitia Acuña	Revisa	Patricio Febre Cisternas	Aprueba	Coordinador Eléctrico Nacional
Cargo	Ingeniero de Proyectos	Cargo	Experto Técnico	Cargo	
Firma		Firma		Firma	
Fecha	08/09/2021	Fecha	08/09/2021	Fecha	08/09/2021

INGENIERÍA, MANTENIMIENTO Y EFICIENCIA ENERGÉTICA SPA, RUT: 76.696.552-0, Dirección: Errázuriz #1178, Oficina N° 75, Valparaíso, E-mail: [PATRICIO.FEBRE@IMEE.CL](mailto:PATRICIO.FEBRE@IMEE.CL), Contacto: +56-9-93279529, Sitio Web: [WWW.IMEE.CL](http://WWW.IMEE.CL).

B.1 CERTIFICADO DE CALIBRACIÓN DEL MEDIDOR DE FACTURACIÓN

FT-LAB-7.8c 	<b>CERTIFICADO DE EXACTITUD</b> LABORATORIO DE TECNORED S.A. MEDIDORES DE ENERGÍA ELÉCTRICA
--	---

FOLIO: 38168

<table border="1" style="width: 100%; border-collapse: collapse;"> <tr> <th colspan="2" style="text-align: center;">ANTECEDENTES DEL CLIENTE</th> </tr> <tr> <td>N° / Fecha de Solicitud</td> <td>: GOTP-2020/768 / 14.08.2020</td> </tr> <tr> <td>Fecha Calibración</td> <td>: 02.03.2021</td> </tr> <tr> <td>Medidor</td> <td>: ION 8600</td> </tr> <tr> <td>Cliente</td> <td>: Tecnored S.A.</td> </tr> <tr> <td>Instalación</td> <td>: Gnr. Placilla</td> </tr> <tr> <td>Subestación</td> <td>: Placilla</td> </tr> </table> <table border="1" style="width: 100%; border-collapse: collapse;"> <tr> <th colspan="2" style="text-align: center;">ANTECEDENTES DEL MEDIDOR</th> </tr> <tr> <td>Marca</td> <td>: Schneider Electric</td> </tr> <tr> <td>Modelo</td> <td>: P8600A4COH5E0B0A</td> </tr> <tr> <td>N° de Serie</td> <td>: PT-0612A152-01</td> </tr> <tr> <td>Estado</td> <td>: En Servicio</td> </tr> <tr> <td>Año Fabricación</td> <td>: 2006</td> </tr> <tr> <td>Clase Exactitud (%)</td> <td>: 0,2</td> </tr> <tr> <td>Constante Med.</td> <td>: 1</td> </tr> </table> <table border="1" style="width: 100%; border-collapse: collapse;"> <tr> <th colspan="2" style="text-align: center;">PATRON DE CALIBRACIÓN</th> </tr> <tr> <td>Marca</td> <td>: MTE</td> </tr> <tr> <td>Modelo</td> <td>: PTS 3.3</td> </tr> <tr> <td>N° Serie</td> <td>: 29564</td> </tr> <tr> <td>Clase de Exactitud</td> <td>: 0,05</td> </tr> <tr> <td>Trazabilidad</td> <td>: Laboratorio Tecnored</td> </tr> </table> <table border="1" style="width: 100%; border-collapse: collapse;"> <tr> <th colspan="2" style="text-align: center;">CONDICIONES DE MEDIDA</th> </tr> <tr> <td>Lugar de Calibración</td> <td>: SE Placilla</td> </tr> <tr> <td>Tipo de Medida</td> <td>: W.ESTRELLA/ACTIVO</td> </tr> <tr> <td>Tensión Aplicada</td> <td>: 63,5 (V)</td> </tr> <tr> <td>Corriente Nominal</td> <td>: 5 (A)</td> </tr> <tr> <td>N° de Elementos</td> <td>: 3</td> </tr> <tr> <td>Método Calibración</td> <td>: Comparación Directa</td> </tr> <tr> <td>Frecuencia (Hz)</td> <td>: 50 (HZ)</td> </tr> <tr> <td>Temperatura (C°)</td> <td>: 17,2</td> </tr> <tr> <td>Humedad (%)</td> <td>: 38,2</td> </tr> <tr> <td>Calibrador</td> <td>: M. Flores - C. Colarte</td> </tr> </table>	ANTECEDENTES DEL CLIENTE		N° / Fecha de Solicitud	: GOTP-2020/768 / 14.08.2020	Fecha Calibración	: 02.03.2021	Medidor	: ION 8600	Cliente	: Tecnored S.A.	Instalación	: Gnr. Placilla	Subestación	: Placilla	ANTECEDENTES DEL MEDIDOR		Marca	: Schneider Electric	Modelo	: P8600A4COH5E0B0A	N° de Serie	: PT-0612A152-01	Estado	: En Servicio	Año Fabricación	: 2006	Clase Exactitud (%)	: 0,2	Constante Med.	: 1	PATRON DE CALIBRACIÓN		Marca	: MTE	Modelo	: PTS 3.3	N° Serie	: 29564	Clase de Exactitud	: 0,05	Trazabilidad	: Laboratorio Tecnored	CONDICIONES DE MEDIDA		Lugar de Calibración	: SE Placilla	Tipo de Medida	: W.ESTRELLA/ACTIVO	Tensión Aplicada	: 63,5 (V)	Corriente Nominal	: 5 (A)	N° de Elementos	: 3	Método Calibración	: Comparación Directa	Frecuencia (Hz)	: 50 (HZ)	Temperatura (C°)	: 17,2	Humedad (%)	: 38,2	Calibrador	: M. Flores - C. Colarte	<table border="1" style="width: 100%; border-collapse: collapse;"> <tr> <th colspan="8" style="text-align: center;">RESULTADOS DE LA COMPONENTE ACTIVA</th> </tr> <tr> <th rowspan="2">N</th> <th rowspan="2">Fase</th> <th rowspan="2">Cte. %</th> <th rowspan="2">Factor</th> <th colspan="2">Componente Activa Directa</th> <th colspan="2">Componente Activa Reversa</th> </tr> <tr> <th>Error (%)</th> <th>Límite Norma (%)</th> <th>Error (%)</th> <th>Límite Norma (%)</th> </tr> <tr> <td>1</td> <td>123</td> <td>100</td> <td>1</td> <td>-0,031</td> <td>± 0,2</td> <td>-0,039</td> <td>± 0,2</td> </tr> <tr> <td>2</td> <td>123</td> <td>100</td> <td>0,5</td> <td>-0,047</td> <td>± 0,3</td> <td>-0,042</td> <td>± 0,3</td> </tr> <tr> <td>3</td> <td>123</td> <td>10</td> <td>1</td> <td>-0,033</td> <td>± 0,2</td> <td>0,001</td> <td>± 0,2</td> </tr> <tr> <td>4</td> <td>123</td> <td>10</td> <td>0,5</td> <td>-0,059</td> <td>± 0,3</td> <td>-0,062</td> <td>± 0,3</td> </tr> <tr> <td>5</td> <td>1</td> <td>100</td> <td>1</td> <td>-0,041</td> <td>± 0,3</td> <td>-0,021</td> <td>± 0,3</td> </tr> <tr> <td>6</td> <td>2</td> <td>100</td> <td>1</td> <td>-0,036</td> <td>± 0,3</td> <td>-0,012</td> <td>± 0,3</td> </tr> <tr> <td>7</td> <td>3</td> <td>100</td> <td>1</td> <td>-0,016</td> <td>± 0,3</td> <td>-0,092</td> <td>± 0,3</td> </tr> <tr> <td>8</td> <td>1</td> <td>100</td> <td>0,5</td> <td>-0,050</td> <td>± 0,4</td> <td>0,007</td> <td>± 0,4</td> </tr> <tr> <td>9</td> <td>2</td> <td>100</td> <td>0,5</td> <td>-0,072</td> <td>± 0,4</td> <td>-0,052</td> <td>± 0,4</td> </tr> <tr> <td>10</td> <td>3</td> <td>100</td> <td>0,5</td> <td>-0,057</td> <td>± 0,4</td> <td>-0,005</td> <td>± 0,4</td> </tr> </table> <table border="1" style="width: 100%; border-collapse: collapse;"> <tr> <th colspan="8" style="text-align: center;">RESULTADOS DE LA COMPONENTE REACTIVA</th> </tr> <tr> <th rowspan="2">N</th> <th rowspan="2">Fase</th> <th rowspan="2">Cte. %</th> <th rowspan="2">Factor</th> <th colspan="2">Componente Reactiva Directa</th> <th colspan="2">Componente Reactiva Reversa</th> </tr> <tr> <th>Error (%)</th> <th>Límite Norma (%)</th> <th>Error (%)</th> <th>Límite Norma (%)</th> </tr> <tr> <td>1</td> <td>123</td> <td>100</td> <td>1</td> <td>-0,045</td> <td>± 2,0</td> <td>-0,056</td> <td>± 2,0</td> </tr> <tr> <td>2</td> <td>123</td> <td>100</td> <td>0,5</td> <td>0,002</td> <td>± 2,0</td> <td>-0,060</td> <td>± 2,0</td> </tr> <tr> <td>3</td> <td>123</td> <td>10</td> <td>1</td> <td>-0,035</td> <td>± 2,0</td> <td>-0,022</td> <td>± 2,0</td> </tr> <tr> <td>4</td> <td>123</td> <td>10</td> <td>0,5</td> <td>-0,061</td> <td>± 2,0</td> <td>-0,030</td> <td>± 2,0</td> </tr> <tr> <td>5</td> <td>1</td> <td>100</td> <td>1</td> <td>-0,022</td> <td>± 3,0</td> <td>-0,024</td> <td>± 3,0</td> </tr> <tr> <td>6</td> <td>2</td> <td>100</td> <td>1</td> <td>-0,067</td> <td>± 3,0</td> <td>-0,086</td> <td>± 3,0</td> </tr> <tr> <td>7</td> <td>3</td> <td>100</td> <td>1</td> <td>-0,047</td> <td>± 3,0</td> <td>-0,057</td> <td>± 3,0</td> </tr> <tr> <td>8</td> <td>1</td> <td>100</td> <td>0,5</td> <td>0,003</td> <td>± 3,0</td> <td>0,027</td> <td>± 3,0</td> </tr> <tr> <td>9</td> <td>2</td> <td>100</td> <td>0,5</td> <td>-0,085</td> <td>± 3,0</td> <td>-0,053</td> <td>± 3,0</td> </tr> <tr> <td>10</td> <td>3</td> <td>100</td> <td>0,5</td> <td>-0,075</td> <td>± 3,0</td> <td>0,050</td> <td>± 3,0</td> </tr> </table> <table border="1" style="width: 100%; border-collapse: collapse;"> <tr> <th colspan="2" style="text-align: center;">OBSERVACIONES Y CONCLUSIONES</th> </tr> <tr> <td colspan="2">                 Los errores encontrados cumplen con la Normativa Vigente IEC 62053-22 (ITEM 8.1). Tecnored S.A., declina toda responsabilidad por el uso indebido que se hicieran de este certificado. Este documento no puede ser reproducido en forma parcial.             </td> </tr> </table> <div style="text-align: right; margin-right: 20px;">                   Jaime Eduardo García Collao                  Jefe Área Laboratorio y Medidas             </div>	RESULTADOS DE LA COMPONENTE ACTIVA								N	Fase	Cte. %	Factor	Componente Activa Directa		Componente Activa Reversa		Error (%)	Límite Norma (%)	Error (%)	Límite Norma (%)	1	123	100	1	-0,031	± 0,2	-0,039	± 0,2	2	123	100	0,5	-0,047	± 0,3	-0,042	± 0,3	3	123	10	1	-0,033	± 0,2	0,001	± 0,2	4	123	10	0,5	-0,059	± 0,3	-0,062	± 0,3	5	1	100	1	-0,041	± 0,3	-0,021	± 0,3	6	2	100	1	-0,036	± 0,3	-0,012	± 0,3	7	3	100	1	-0,016	± 0,3	-0,092	± 0,3	8	1	100	0,5	-0,050	± 0,4	0,007	± 0,4	9	2	100	0,5	-0,072	± 0,4	-0,052	± 0,4	10	3	100	0,5	-0,057	± 0,4	-0,005	± 0,4	RESULTADOS DE LA COMPONENTE REACTIVA								N	Fase	Cte. %	Factor	Componente Reactiva Directa		Componente Reactiva Reversa		Error (%)	Límite Norma (%)	Error (%)	Límite Norma (%)	1	123	100	1	-0,045	± 2,0	-0,056	± 2,0	2	123	100	0,5	0,002	± 2,0	-0,060	± 2,0	3	123	10	1	-0,035	± 2,0	-0,022	± 2,0	4	123	10	0,5	-0,061	± 2,0	-0,030	± 2,0	5	1	100	1	-0,022	± 3,0	-0,024	± 3,0	6	2	100	1	-0,067	± 3,0	-0,086	± 3,0	7	3	100	1	-0,047	± 3,0	-0,057	± 3,0	8	1	100	0,5	0,003	± 3,0	0,027	± 3,0	9	2	100	0,5	-0,085	± 3,0	-0,053	± 3,0	10	3	100	0,5	-0,075	± 3,0	0,050	± 3,0	OBSERVACIONES Y CONCLUSIONES		Los errores encontrados cumplen con la Normativa Vigente IEC 62053-22 (ITEM 8.1). Tecnored S.A., declina toda responsabilidad por el uso indebido que se hicieran de este certificado. Este documento no puede ser reproducido en forma parcial.	
ANTECEDENTES DEL CLIENTE																																																																																																																																																																																																																																																																													
N° / Fecha de Solicitud	: GOTP-2020/768 / 14.08.2020																																																																																																																																																																																																																																																																												
Fecha Calibración	: 02.03.2021																																																																																																																																																																																																																																																																												
Medidor	: ION 8600																																																																																																																																																																																																																																																																												
Cliente	: Tecnored S.A.																																																																																																																																																																																																																																																																												
Instalación	: Gnr. Placilla																																																																																																																																																																																																																																																																												
Subestación	: Placilla																																																																																																																																																																																																																																																																												
ANTECEDENTES DEL MEDIDOR																																																																																																																																																																																																																																																																													
Marca	: Schneider Electric																																																																																																																																																																																																																																																																												
Modelo	: P8600A4COH5E0B0A																																																																																																																																																																																																																																																																												
N° de Serie	: PT-0612A152-01																																																																																																																																																																																																																																																																												
Estado	: En Servicio																																																																																																																																																																																																																																																																												
Año Fabricación	: 2006																																																																																																																																																																																																																																																																												
Clase Exactitud (%)	: 0,2																																																																																																																																																																																																																																																																												
Constante Med.	: 1																																																																																																																																																																																																																																																																												
PATRON DE CALIBRACIÓN																																																																																																																																																																																																																																																																													
Marca	: MTE																																																																																																																																																																																																																																																																												
Modelo	: PTS 3.3																																																																																																																																																																																																																																																																												
N° Serie	: 29564																																																																																																																																																																																																																																																																												
Clase de Exactitud	: 0,05																																																																																																																																																																																																																																																																												
Trazabilidad	: Laboratorio Tecnored																																																																																																																																																																																																																																																																												
CONDICIONES DE MEDIDA																																																																																																																																																																																																																																																																													
Lugar de Calibración	: SE Placilla																																																																																																																																																																																																																																																																												
Tipo de Medida	: W.ESTRELLA/ACTIVO																																																																																																																																																																																																																																																																												
Tensión Aplicada	: 63,5 (V)																																																																																																																																																																																																																																																																												
Corriente Nominal	: 5 (A)																																																																																																																																																																																																																																																																												
N° de Elementos	: 3																																																																																																																																																																																																																																																																												
Método Calibración	: Comparación Directa																																																																																																																																																																																																																																																																												
Frecuencia (Hz)	: 50 (HZ)																																																																																																																																																																																																																																																																												
Temperatura (C°)	: 17,2																																																																																																																																																																																																																																																																												
Humedad (%)	: 38,2																																																																																																																																																																																																																																																																												
Calibrador	: M. Flores - C. Colarte																																																																																																																																																																																																																																																																												
RESULTADOS DE LA COMPONENTE ACTIVA																																																																																																																																																																																																																																																																													
N	Fase	Cte. %	Factor	Componente Activa Directa		Componente Activa Reversa																																																																																																																																																																																																																																																																							
				Error (%)	Límite Norma (%)	Error (%)	Límite Norma (%)																																																																																																																																																																																																																																																																						
1	123	100	1	-0,031	± 0,2	-0,039	± 0,2																																																																																																																																																																																																																																																																						
2	123	100	0,5	-0,047	± 0,3	-0,042	± 0,3																																																																																																																																																																																																																																																																						
3	123	10	1	-0,033	± 0,2	0,001	± 0,2																																																																																																																																																																																																																																																																						
4	123	10	0,5	-0,059	± 0,3	-0,062	± 0,3																																																																																																																																																																																																																																																																						
5	1	100	1	-0,041	± 0,3	-0,021	± 0,3																																																																																																																																																																																																																																																																						
6	2	100	1	-0,036	± 0,3	-0,012	± 0,3																																																																																																																																																																																																																																																																						
7	3	100	1	-0,016	± 0,3	-0,092	± 0,3																																																																																																																																																																																																																																																																						
8	1	100	0,5	-0,050	± 0,4	0,007	± 0,4																																																																																																																																																																																																																																																																						
9	2	100	0,5	-0,072	± 0,4	-0,052	± 0,4																																																																																																																																																																																																																																																																						
10	3	100	0,5	-0,057	± 0,4	-0,005	± 0,4																																																																																																																																																																																																																																																																						
RESULTADOS DE LA COMPONENTE REACTIVA																																																																																																																																																																																																																																																																													
N	Fase	Cte. %	Factor	Componente Reactiva Directa		Componente Reactiva Reversa																																																																																																																																																																																																																																																																							
				Error (%)	Límite Norma (%)	Error (%)	Límite Norma (%)																																																																																																																																																																																																																																																																						
1	123	100	1	-0,045	± 2,0	-0,056	± 2,0																																																																																																																																																																																																																																																																						
2	123	100	0,5	0,002	± 2,0	-0,060	± 2,0																																																																																																																																																																																																																																																																						
3	123	10	1	-0,035	± 2,0	-0,022	± 2,0																																																																																																																																																																																																																																																																						
4	123	10	0,5	-0,061	± 2,0	-0,030	± 2,0																																																																																																																																																																																																																																																																						
5	1	100	1	-0,022	± 3,0	-0,024	± 3,0																																																																																																																																																																																																																																																																						
6	2	100	1	-0,067	± 3,0	-0,086	± 3,0																																																																																																																																																																																																																																																																						
7	3	100	1	-0,047	± 3,0	-0,057	± 3,0																																																																																																																																																																																																																																																																						
8	1	100	0,5	0,003	± 3,0	0,027	± 3,0																																																																																																																																																																																																																																																																						
9	2	100	0,5	-0,085	± 3,0	-0,053	± 3,0																																																																																																																																																																																																																																																																						
10	3	100	0,5	-0,075	± 3,0	0,050	± 3,0																																																																																																																																																																																																																																																																						
OBSERVACIONES Y CONCLUSIONES																																																																																																																																																																																																																																																																													
Los errores encontrados cumplen con la Normativa Vigente IEC 62053-22 (ITEM 8.1). Tecnored S.A., declina toda responsabilidad por el uso indebido que se hicieran de este certificado. Este documento no puede ser reproducido en forma parcial.																																																																																																																																																																																																																																																																													

<b>TECNORED S.A.</b> Cerro El Plomo 3819 Barrio Industrial Curauma, Valparaíso Fono: 56-32-2452580 fax: 56-32-2452571 www.tecnored.cl ventas@tecnored.cl
---

B.2 CERTIFICADO DE CALIBRACIÓN DEL MEDIDOR DE ENERGÍA CONECTADO A LOS BORNES DEL GENERADOR DE LA UNIDAD N°2

FT-LAB-7.8c



**CERTIFICADO DE EXACTITUD**  
LABORATORIO DE TECNORED S.A.  
MEDIDORES DE ENERGÍA ELÉCTRICA

FOLIO: 505933

ANTECEDENTES DEL CLIENTE			
N° / Fecha de Solicitud	: 0413_26.05.2021		
Fecha Calibración	: 27-05-2021		
Medidor	: ION 8650		
Cliente	: Tecnored S.A.		
Instalación	:		
Subestación	:		

ANTECEDENTES DEL MEDIDOR			
Marca	: Schneider Electric		
Modelo	: M8650A4COHSE1B0A-AA566		
N° de Serie	: MW-1811A713-02		
Estado	: Usado		
Año Fabricación	: 2018		
Clase Exactitud (%)	: 0.2		
Constante Med.	: 1		

PATRON DE CALIBRACIÓN			
Marca	: Clou		
Modelo	: C13115		
N° Serie	: 20171801		
Clase de Exactitud	: 0,05		
Trazabilidad	: Laboratorio Tecnored		

CONDICIONES DE MEDIDA			
Lugar de Calibración	: Laboratorio Tecnored		
Tipo de Medida	: W.ESTRELLA/ACTIVO		
Tensión Aplicada	: 63,5 (V)		
Corriente Nominal	: 5 (A)		
N° de Elementos	: 3		
Método Calibración	: Comparación Directa		
Frecuencia (Hz)	: 50 (HZ)		
Temperatura (C°)	: 21.7		
Humedad (%)	: 42.5		
Calibrador	: E.López		

RESULTADOS DE LA COMPONENTE ACTIVA							
N	Fase	Cte.%	Factor	Componente Activa Directa		Componente Activa Reversa	
				Error (%)	Límite Norma (%)	Error(%)	Límite Norma (%)
1	123	100	1	0.031	± 0.2	0.027	± 0.2
2	123	100	0.5	0.025	± 0.3	0.040	± 0.3
3	123	10	1	0.034	± 0.2	0.036	± 0.2
4	123	10	0.5	0.043	± 0.3	0.043	± 0.3
5	1	100	1	0.031	± 0.3	0.030	± 0.3
6	2	100	1	0.040	± 0.3	0.043	± 0.3
7	3	100	1	0.017	± 0.3	0.023	± 0.3
8	1	100	0.5	0.058	± 0.4	0.080	± 0.4
9	2	100	0.5	0.094	± 0.4	0.096	± 0.4
10	3	100	0.5	-0.027	± 0.4	-0.010	± 0.4

RESULTADOS DE LA COMPONENTE REACTIVA							
N	Fase	Cte.%	Factor	Componente Reactiva Directa		Componente Reactiva Reversa	
				Error (%)	Límite Norma (%)	Error(%)	Límite Norma (%)
1	123	100	1	0.021	± 2.0	0.032	± 2.0
2	123	100	0.5	0.002	± 2.0	0.019	± 2.0
3	123	10	1	0.009	± 2.0	0.050	± 2.0
4	123	10	0.5	-0.012	± 2.0	0.058	± 2.0
5	1	100	1	0.020	± 3.0	0.031	± 3.0
6	2	100	1	0.029	± 3.0	0.041	± 3.0
7	3	100	1	0.008	± 3.0	0.012	± 3.0
8	1	100	0.5	0.059	± 3.0	0.029	± 3.0
9	2	100	0.5	-0.033	± 3.0	0.017	± 3.0
10	3	100	0.5	0.035	± 3.0	0.004	± 3.0

**OBSERVACIONES Y CONCLUSIONES**

Los errores encontrados cumplen con la Normativa Vigente IEC 62053-22 (ITEM 8.1). Tecnored S.A., declina toda responsabilidad por el uso indebido que se hicieran de este certificado. Este documento no puede ser reproducido en forma parcial.



  



Jaime Eduardo García Collao  
Jefe Área Certificación y Medidas

**TECNORED S.A.**  
Cerro El Plomo 3819 Barrio Industrial Curauma, Valparaíso  
Fono: 56-32-2452580 fax: 56-32-2452571  
www.tecnored.cl ventas@tecnored.cl

	<b>INFORME TÉCNICO DE LA PRUEBA: “POTENCIA MÁXIMA” CENTRAL PLACILLA (revisión 1)</b> Código: PPM-CEN024-2021-CC-DCO-0	
	miércoles 08 septiembre 2021	
Mandante	Revisión 1	Proveedor

## ANEXO C (ESPECIFICACIONES TÉCNICAS DE LA UNIDAD N°2)

27

Realiza	Francisco Gorigoitia Acuña	Revisa	Patricio Febre Cisternas	Aprueba	Coordinador Eléctrico Nacional
Cargo	Ingeniero de Proyectos	Cargo	Experto Técnico	Cargo	
Firma		Firma		Firma	
Fecha	08/09/2021	Fecha	08/09/2021	Fecha	08/09/2021

INGENIERÍA, MANTENIMIENTO Y EFICIENCIA ENERGÉTICA SPA, RUT: 76.696.552-0, Dirección: Errázuriz #1178, Oficina N° 75, Valparaíso, E-mail: [PATRICIO.FEBRE@IMEE.CL](mailto:PATRICIO.FEBRE@IMEE.CL), Contacto: +56-9-93279529, Sitio Web: [WWW.IMEE.CL](http://WWW.IMEE.CL).



## 2. ESPECIFICACIONES TÉCNICAS GENERADOR MODELO DQKC

Las siguientes especificaciones técnicas, muestran el detalle de los componentes principales del grupo generador.

### 1.4. MOTOR

Fabricante : CUMMINS ENGINE CO.  
Modelo : QSK60-G3  
Procedencia : UK  
Nº cilindros : 16 en V  
Desplazamiento : 30,5 lts.  
Aspiración : Turbo cargado aftercooled  
Ciclos : 4 tiempos  
Potencia ISO std. : 1304 kWm @ 1.500 RPM, trabajo continuo  
Consumo combustible a 80% de carga : 283 lts./hr. Diesel N°2  
Refrigeración : Radiador para trabajo pesado montado en la base.  
Diámetro y carrera : 6,25" (159 mm) x 7,48" (190 mm)

#### 1.4.1. BASE TIPO RIELES

Base tipo rieles, soportante del alternador, motor y radiador.

#### 1.4.2. SISTEMA DE COMBUSTIBLE

Control electrónico de combustible (E.F.C.), original de CUMMINS ENGINE CO., pick up magnético, actuador para el control y monitoreo de velocidad, bomba de combustible "PT", válvula eléctrica de corte de combustible (24 volts), módulo repartidor con sensor de cargas, reostato de ajuste fino de velocidad, filtros de combustible doble, con separador de agua tipo cartridge, válvula check.

#### 1.4.3. SISTEMA DE REFRIGERACION

Radiador integrado a la base, con ventilador expelente para una temperatura ambiente de 50° C, protecciones del ventilador, conexiones entre motor y radiador, Manifold de agua y calefactores de agua (240 VAC), para partidas en frío. Filtro de agua doble tipo cartridge con elementos inhibidores de corrosión (DCA). Las características del refrigerante deberán contener aproximadamente un 50% de concentración de Ethylene Glicol.

#### 1.4.4. SISTEMA DE LUBRICACION

Bomba de aceite tipo engranajes, calefactor de aceite, cárter de aceite de una capacidad de 397 litros, varilla medidora de nivel aceite y tubo de llenado de aceite, cinco filtros de aceite de flujo total tipo cartridge, aceite multigrado 15 W 40 es el recomendado.

#### 1.4.5. SISTEMA DE ADMISION DE AIRE

Múltiple de admisión de aire, filtro de aire de doble etapa (tipo seco), eyector de polvo, dos indicadores de servicio (saturación de filtro de aire).

#### 1.4.6. SISTEMA DE ESCAPE

Múltiple de escape tipo seco, codos de escapes de 90°, tubos flexibles de escape, flanges de conexión, empaquetaduras, pernos y silenciadores de escape tipo industrial.

#### 1.4.7. SISTEMA DE ARRANQUE

El sistema de partida considera un motor de arranque eléctrico, incluyendo todos los accesorios necesarios de 24 Vdc., baterías de arranque, soporte de baterías y cables.

#### 1.4.8. SISTEMA ELECTRICO

El sistema eléctrico del motor es de 24 Vdc. con un alternador de 45 amp.

### 1.5. GENERADOR

Todos los Generadores instalados en los equipos serán del mismo tipo y de acuerdo a las características aquí descritas:

Fabricante :	NEWAGE STAMFORD
Tipo :	Sin escobillas Trifásico con excitación PMG
Voltaje :	230/400 V con neutro accesible.
Frecuencia :	50 Hz, 4 polos
Factor de potencia :	0,8 inductivo
Aislación :	Clase H.
Regulador de voltaje:	Incorporado en el PCC 0,5%
Refrigeración :	Aire forzado, autoventilado
Nº Rodamientos :	Uno (1) prelubricado.

### 1.6. TABLERO DE CONTROL DIGITAL POWER COMMAND PARALLELING

Cada grupo generador tendrá un panel de control **Power Command Paralleling PCC3201**, basado en un microprocesador que permite un conjunto de funciones de monitoreo, medición, y control de la unidad. Ofrece un nivel avanzado de funciones para una confiabilidad y óptimo rendimiento del generador. El control ofrece un amplio rango de control, medición y protección análogo digital integrado al tablero, eliminando la necesidad de incorporar en forma separada dispositivos como, regulador de voltaje, relés de protección, de sobrecorriente, voltaje, frecuencia. El control también tiene integrado dispositivos tales como sincronizadores repartidores de carga. Incluye los siguientes elementos de protección y control:





#### Control de Paralelismo

- Regulación de voltaje
- Control de voltaje aleatorio

#### Gobernación

- Regulación de frecuencia
- Repartidor de carga, isocrona
- Repartidor de carga, isocrona reactiva

#### Sincronización

- Rango
- Diferencial de Frecuencia
- Diferencial de voltaje
- Protección de permisibilidad
- Sistema de control
- Sensor barra aislada

#### Protecciones de la unidad y Paradas de Emergencia

- Baja Presión de aceite (Alarma)
- Baja temperatura del refrigerante (Alarma)
- Alta temperatura del refrigerante (Alarma)
- Bajo nivel de agua (Alarma, Parada-emergencia- programable)
- Bajo nivel de combustible
- Sensor de baja presión de aceite
- Sensor de baja temperatura del refrigerante
- Baja presión de aceite (Parada-emergencia)
- Alta temperatura del refrigerante (Parada-emergencia)
- Falla en el arranque (Parada-emergencia)
- Sobrecarga (Parada-emergencia)
- Falla en el pick-up magnético (Parada-emergencia)
- Sobrevelocidad (Parada-emergencia, 115% de la nominal)
- Parada-Emergencia
- Sobrecarga (110% del rating Prime por 5 segundos)
- Sobrecorriente (51)
- Corto circuito
- Falla en la sincronización
- Falla en el cierre
- Alto voltaje AC (59)
- Bajo voltaje AC (27)
- Potencia Inversa (32)
- Baja Frecuencia (81u)
- Pérdida en la Excitación (40)
- Pérdida de fase

#### Instrumentos digitales AC

- Kilowátmetro
- Frecuencímetro
- Voltímetro AC
- Amperímetro AC
- Medidor de factor de potencia
- Medidores digitales

C.2 DATA-SHEET-FR0628300-QSK-60

	<b>Cummins Inc.</b> Columbus, Indiana 47201 <b>Engine Data Sheet</b>	Basic Engine Model: <b>QSK60-G3</b>	Curve Number: <b>FR-6283</b>	<b>G-DRIVE</b> <b>QSK</b> <b>1</b>
		Engine Critical Parts List: <b>CPL: 2824</b>	Date: <b>4Dec03</b>	
Displacement : 60.2 litre (3673 in <sup>3</sup> )		Bore : 159 mm (6.25 in.) Stroke : 190 mm (7.48 in.)		
No. of Cylinders : 16		Aspiration : Turbocharged and Low Temperature Aftercooled (2 Pump / 2 Loop)		
Emissions: Refer to Emission Data Sheet for Details.				

**Engine Ratings:**

Engine Speed RPM	Standby Power		Prime Power		Continuous Power	
	kWm	BHP	kWm	BHP	kWm	BHP
1500	1790	2399	1615	2165	1305	1749

**Engine Fuel Consumption @ 1500 RPM**

OUTPUT POWER			FUEL CONSUMPTION			
%	kWm	BHP	kg/ kWm-h	lb/ BHP-h	litre/ hour	U.S. Gal/ hour
<b>STANDBY POWER</b>						
100	1790	2399	0.193	0.317	406	107.1
<b>PRIME POWER</b>						
100	1615	2165	0.191	0.314	363	95.7
75	1211	1624	0.190	0.312	270	71.3
50	808	1082	0.200	0.329	190	50.2
25	404	541	0.235	0.387	112	29.5
<b>CONTINUOUS POWER</b>						
100	1305	1749	0.190	0.313	292	77.1

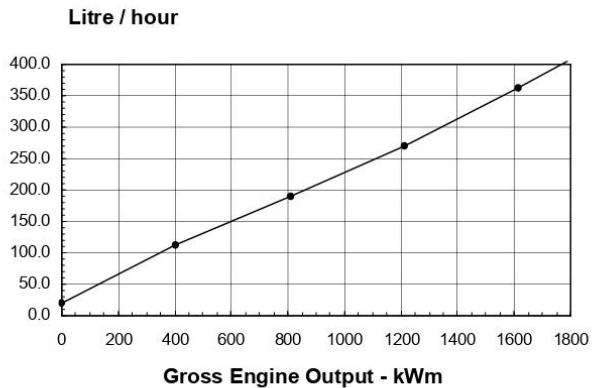

**Power Derate Curves:**

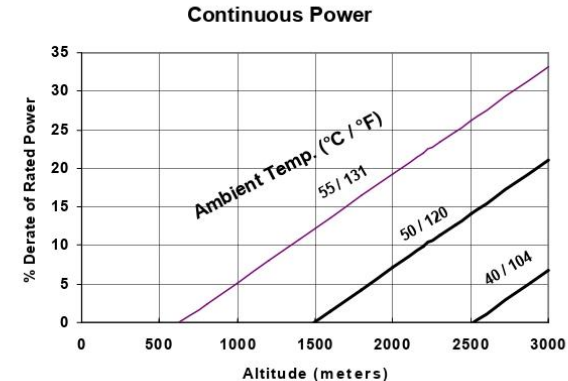
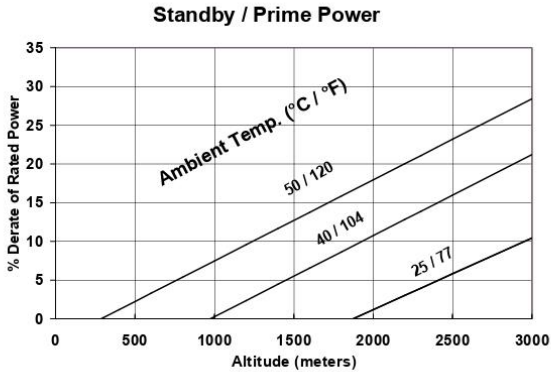

**Operation At Elevated Temperature And Altitude:**

For sustained operation above these conditions, derate by an additional 3.3% per 300 m (1000 ft), and 10% per 10° C (18° F).

**CONVERSIONS:**(litres = U.S. Gal x 3.785) (U.S. Gal = litres x 0.2642)

These guidelines have been formulated to ensure proper application of generator drive engines in A.C. generator set installations. **STANDBY POWER RATING:** Applicable for supplying emergency power for the duration of the utility power outage. No overload capability is available for this rating. Under no condition is an engine allowed to operate in parallel with the public utility at the Standby Power rating. This rating should be applied where reliable utility power is available. A Standby rated engine should be sized for a maximum of an 80% average load factor and 200 hours of operation per year. This includes less than 25 hours per year at the Standby Power rating. Standby ratings should never be applied except in true emergency power outages. Negotiated power outages contracted with a utility company are not considered an emergency. **PRIME POWER RATING:** Applicable for supplying electric power in lieu of commercially purchased power. Prime Power applications must be in the form of one of the following two categories: **UNLIMITED TIME RUNNING PRIME POWER:** Prime Power is available for an unlimited number of hours per year in a variable load application. Variable load should not exceed a 70% average of the Prime Power rating during any operating period of 260 hours. The total operating time at 100% Prime Power shall not exceed 500 hours per year. A 10% overload capability is available for a period of 1 hour within a 12-hour period of operation. Total operating time at the 10% overload power shall not exceed 25 hours per year. **LIMITED TIME RUNNING PRIME POWER:** Limited Time Prime Power is available for a limited number of hours in a non-variable load application. It is intended for use in situations where power outages are contracted, such as in utility power curtailment. Engines may be operated in parallel to the public utility up to 750 hours per year at power levels never to exceed the Prime Power rating. The customer should be aware, however, that the life of any engine will be reduced by this constant high load operation. Any operation exceeding 750 hours per year at the Prime Power rating should use the Continuous Power rating. **CONTINUOUS POWER RATING:** Applicable for supplying utility power at a constant 100% load for an unlimited number of hours per year. No overload capability is available for this rating.

**Data Subject to Change Without Notice**

Reference AEB 10.47 for determining Electrical Output.  
 Data shown above represent gross engine performance capabilities obtained and corrected in accordance with ISO-3046 conditions of 100 kPa (29.53 in Hg) barometric pressure [110 m (361 ft) altitude], 25 °C (77 °F) air inlet temperature, and relative humidity of 30% with No. 2 diesel or a fuel corresponding to ASTM D2. Derates shown are based on 15 in H<sub>2</sub>O air intake restriction and 2 in Hg exhaust back pressure.  
 The fuel consumption data is based on No. 2 diesel fuel weight at 0.85 kg/litre (7.1 lbs/U.S. gal). Power output curves are based on the engine operating with fuel system, water pump and lubricating oil pump; not included are battery charging alternator, fan, optional equipment and driven components.  
 Data Status: Limited Production  
 Data Tolerance: ± 5%  
 Chief Engineer:  

# Cummins Inc. Engine Data Sheet

**ENGINE MODEL : QSK60-G3**

**CONFIGURATION NUMBER : D593002GX03**

**DATA SHEET : DS-6283-LP**

**DATE : 4Dec03**

**PERFORMANCE CURVE : FR-6283**

**INSTALLATION DIAGRAM**

• Fan to Flywheel : 3170381

**CPL NUMBER**

• Engine Critical Parts List : 2824

**GENERAL ENGINE DATA**

Type.....	4-Cycle; 60° Vee; 16-Cylinder Diesel	
Aspiration .....	Turbocharged and Low Temperature Aftercooled (2 Pump / 2 Loop)	
Bore x Stroke .....	— mm x mm (in x in)	159 x 190 (6.25 x 7.48)
Displacement.....	— litre (in <sup>3</sup> )	60.2 (3673)
Compression Ratio.....		14.5 : 1
<b>Dry Weight</b>		
Fan to Flywheel Engine (with SAE 0 Flywheel and Flywheel Housing).....	— kg (lb)	7185 (15835)
<b>Wet Weight</b>		
Fan to Flywheel Engine.....	— kg (lb)	7540 (16620)
<b>Moment of Inertia of Rotating Components</b>		
• with FW 6043 Flywheel (SAE 0).....	— kg • m <sup>2</sup> (lb <sub>m</sub> • ft <sup>2</sup> )	15.77 (375.5)
• with FW 6037 Flywheel (SAE 00).....	— kg • m <sup>2</sup> (lb <sub>m</sub> • ft <sup>2</sup> )	26.23 (622.4)
Center of Gravity from Front Face of Block .....	— mm (in)	1001 (39.4)
Center of Gravity Above Crankshaft Centerline .....	— mm (in)	219 (8.6)
Maximum Static Loading at Rear Main Bearing.....	— kg (lb)	1134 (2500)

**ENGINE MOUNTING**

Maximum Bending Moment at Rear Face of Block .....	— N • m (lb • ft)	10350 (7634)
--	-------------------	--------------

**EXHAUST SYSTEM**

Maximum Back Pressure at 1500 RPM (Standby Power).....	— mm Hg (in Hg)	51 (2)
--	-----------------	--------

**AIR INDUCTION SYSTEM**

<b>Maximum Intake Air Restriction</b>		
• with Dirty Filter Element.....	— kPa (in H <sub>2</sub> O)	6.2 (25)
• with Clean Filter Element.....	— kPa (in H <sub>2</sub> O)	3.7 (15)

**COOLING SYSTEM (Separate Circuit Aftercooling Required)**

Coolant Capacity — Engine .....	— litre (US gal)	157 (42)
— Aftercoolers.....	— litre (US gal)	34 (9)
Minimum Pressure Cap (for Cooling Systems with less than 2m [6 ft.] Static Head) .....	— kPa (psi)	76 (11)
Maximum Static Head of Coolant Above Engine Crank Centerline.....	— m (ft)	18.3 (60)

**Jacket Water Circuit Requirements:**

Maximum Coolant Friction Head External to Engine — 1500 rpm .....	— kPa (psi)	48 (7)
Maximum Top Tank Temperature for Standby / Prime Power.....	— °C (°F)	104 / 100 (220 / 212)
Thermostat (Modulating) Range.....	— °C (°F)	82 - 93 (180 - 200)

**Aftercooler Circuit Requirements:**

Maximum Coolant Friction Head External to Engine — 1500 rpm .....	— kPa (psi)	35 (5)
Maximum Inlet Water Temperature to Aftercoolers @ 25 °C (77 °F) .....	— °C (°F)	49 (120)
Maximum Inlet Water Temperature to Aftercoolers .....	— °C (°F)	65 (150)
Thermostat (Modulating) Range.....	— °C (°F)	46 - 57 (115 - 135)

**LUBRICATION SYSTEM**

Oil Pressure @ Idle Speed .....	— kPa (psi)	138 (20)
@ Governed Speed.....	— kPa (psi)	345-483 (50-70)
Maximum Oil Temperature .....	— °C (°F)	121 (250)
Oil Capacity with OP6073 Oil Pan: Low-High.....	— litre (US gal)	231-261 (61-69)
Total System Capacity (with Combo Filter) .....	— litre (US gal)	280 (74)

**FUEL SYSTEM**

Type Injection System.....	Cummins HPI-PT
Maximum Restriction at PT Fuel Injection Pump — with Clean Fuel Filter.....	— mm Hg (in Hg) 120 (4.0)
— with Dirty Fuel Filter.....	— mm Hg (in Hg) 203 (8.0)
Maximum Allowable Head on Injector Return Line (Consisting of Friction Head and Static Head).....	— mm Hg (in Hg) 229 (9.0)
Maximum Fuel Inlet Temperature.....	°C (°F) 70 (160)
Maximum Fuel Flow to Injection Pump.....	— litre / hr (US gph) 1515 (400)
Maximum Drain Flow.....	— litre / hr (US gph) 1400 (370)

**ELECTRICAL SYSTEM**

Cranking Motor (Heavy Duty, Positive Engagement).....	— volt 24
Battery Charging System, Negative Ground.....	— ampere 40
Maximum Allowable Resistance of Cranking Circuit.....	— ohm 0.002
Minimum Recommended Battery Capacity	
• Cold Soak @ 10 °C (50 °F) and Above.....	— 0°F CCA 1800
• Cold Soak @ 0 °C to 10 °C (32 °F to 50 °F).....	— 0°F CCA 1800
• Cold Soak @ -18 °C to 0 °C (0 °F to 32 °F).....	— 0°F CCA 2200

**COLD START CAPABILITY**

Minimum Ambient Temperature for Cold Start with _____ watt Coolant Heater to Rated Speed.....	— °C (°F) TBD (TBD)
Minimum Ambient Temperature for Unaided Cold Start to Idle Speed.....	— °C (°F) -12 (10)
Minimum Ambient Temperature for NFPA 110 Cold Start (90° F Minimum Coolant Temperature).....	— °C (°F) 10 (50)

**PERFORMANCE DATA**

- All data is based on:
- Engine operating with fuel system, water pump, lubricating oil pump, air cleaner and exhaust silencer; not included are battery charging alternator, fan, and optional driven components.
  - Engine operating with fuel corresponding to grade No. 2-D per ASTM D975.
  - ISO 3046, Part 1, Standard Reference Conditions of:
 

Barometric Pressure :	100 kPa (29.53 in Hg)	Air Temperature :	25 °C (77 °F)
Altitude :	110 m (361 ft)	Relative Humidity :	30%
Air Intake Restriction :	381 mm H <sub>2</sub> O (15 in H <sub>2</sub> O)	Exhaust Restriction :	51 mm Hg (2 in Hg)

Steady State Stability Band at any Constant Load.....	— % +/- 0.25
Estimated Free Field Sound Pressure Level of a Typical Generator Set:	
Excludes Exhaust Noise; at Rated Load and 7.5 m (24.6 ft); @ 1500 rpm.....	— dBA 93.4 (est.)
Exhaust Noise at 1 m Horizontally from Centerline of Exhaust Pipe Outlet Upwards at 45°.....	— dBA 108 (est.)

	STANDBY POWER		PRIME POWER	
	60 hz	50 hz	60 hz	50 hz
Governed Engine Speed.....	1500 rpm		1500 rpm	
Engine Idle Speed.....	700 - 900 rpm		700 - 900 rpm	
Gross Engine Power Output.....	1790 (2399)	1790 (2399)	1615 (2165)	1615 (2165)
Brake Mean Effective Pressure.....	2379 (345)	2379 (345)	2144 (311)	2144 (311)
Piston Speed.....	9.5 (1869)	9.5 (1869)	9.5 (1869)	9.5 (1869)
Friction Horsepower.....	146 (196)	146 (196)	146 (196)	146 (196)
Engine Jacket Water Flow at Stated Friction Head External to Engine:				
• 4 psi Friction Head.....	26.5 (420)	26.5 (420)	26.5 (420)	26.5 (420)
• Maximum Friction Head.....	25.2 (400)	25.2 (400)	25.2 (400)	25.2 (400)
<b>Engine Data</b>				
Intake Air Flow.....	2255 (4780)	2255 (4780)	2150 (4555)	2150 (4555)
Exhaust Gas Temperature.....	440 (820)	440 (820)	415 (775)	415 (775)
Exhaust Gas Flow.....	5525 (11700)	5525 (11700)	5105 (10815)	5105 (10815)
Air to Fuel Ratio.....	26.9:1		28.7:1	
Radiated Heat to Ambient.....	160 (9020)	160 (9020)	145 (8165)	145 (8165)
Heat Rejection to Engine Jacket Radiator.....	460 (26000)	460 (26000)	420 (23950)	420 (23950)
Heat Rejection to Exhaust.....	1120 (63700)	1120 (63700)	1020 (57950)	1020 (57950)
Heat Rejection to Fuel*.....	35 (2000)	35 (2000)	35 (2000)	35 (2000)
<b>Engine Aftercooler Data</b>				
Heat Rejection to Aftercooler Radiator.....	405 (22925)	405 (22925)	355 (20175)	355 (20175)
Aftercooler Water Flow at Stated Friction Head External to Engine:				
• 2 psi Friction Head.....	7.1 (112)	7.1 (112)	7.1 (112)	7.1 (112)
• Maximum Friction Head.....	6.9 (109)	6.9 (109)	6.9 (109)	6.9 (109)

\* This is the maximum heat rejection to fuel, which is at low load

N.A. - Data is Not Available  
 N/A - Not Applicable to this Engine  
 TBD - To Be Determined  
 Columbus, Indiana 47202-3005

**ENGINE MODEL : QSK60-G3**  
**DATA SHEET : DS-6283-LP**  
**DATE : 4Dec03**  
**CURVE NO. : FR-6283**

**Cummins Inc.**

### C.3 SENSORES MOTOR QSK 60 CUMMINS

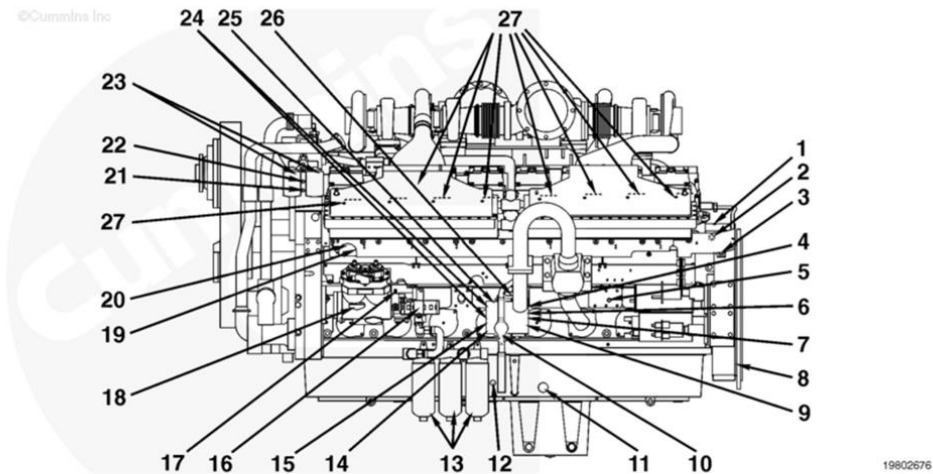

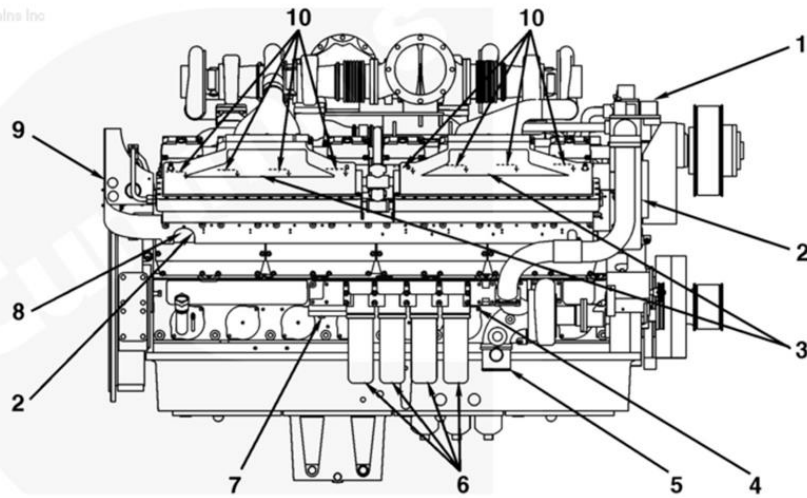

1. Sensor de temperatura de entrada del compresor (únicamente interconexión - instalado por el OEM)
2. Sensor de presión de aceite
3. Sensor de velocidad del motor
4. Sensor de presión de sincronización
5. Puerto de servicio
6. Sensor de presión de aire ambiente
7. Sensor de temperatura del combustible
8. Cubierta del volante
9. Sensor de presión del riel
10. Sensor del paso de gases al cárter
11. Sensor de nivel del aceite
12. Sensor de temperatura de aceite
13. Filtros de combustible
14. Actuador del riel
15. Válvula de cierre del combustible
16. Bomba del combustible
17. Adaptador de desconexión rápida de la bomba del combustible
18. Compresor de aire
19. Sensor de temperatura del múltiple de admisión
20. Sensor de presión del múltiple de admisión
21. Sensor de presión del refrigerante
22. Sensor de temperatura del refrigerante
23. Filtros de refrigerante
24. Actuadores de sincronización
25. Módulo de control electrónico (ECM) QUANTUM™
26. Cuerpo de la válvula de control
27. Sensores de temperatura del gas de escape.



19802677

1. Salida del refrigerante
2. Sensor de temperatura del múltiple de admisión
3. Ensamble del postenfriador
4. Sensor de presión de aceite antes del filtro
5. Entrada de refrigerante
6. Filtros del aceite
7. Sensor de presión del postfiltro de aceite
8. Sensor de presión del múltiple de admisión
9. Módulo de control electrónico (ECM) CENSE™
10. Sensores de temperatura del gas de escape

	<b>INFORME TÉCNICO DE LA PRUEBA: “POTENCIA MÁXIMA” CENTRAL PLACILLA (revisión 1)</b> Código: PPM-CEN024-2021-CC-DCO-0	
	miércoles 08 septiembre 2021	
Mandante	Revisión 1	Proveedor



## ANEXO D (UNILINEAL ELÉCTRICO DE LA UNIDAD)

36

Realiza	Francisco Gorigoitia Acuña	Revisa	Patricio Febre Cisternas	Aprueba	Coordinador Eléctrico Nacional
Cargo	Ingeniero de Proyectos	Cargo	Experto Técnico	Cargo	
Firma		Firma		Firma	
Fecha	08/09/2021	Fecha	08/09/2021	Fecha	08/09/2021





	<b>INFORME TÉCNICO DE LA PRUEBA: “POTENCIA MÁXIMA” CENTRAL PLACILLA (revisión 1)</b> Código: PPM-CEN024-2021-CC-DCO-0	
	miércoles 08 septiembre 2021	
Mandante	Revisión 1	Proveedor

## ANEXO E (CERTIFICADOS DE COMBUSTIBLE)

38

Realiza	Francisco Gorigoitia Acuña	Revisa	Patricio Febre Cisternas	Aprueba	Coordinador Eléctrico Nacional
Cargo	Ingeniero de Proyectos	Cargo	Experto Técnico	Cargo	
Firma		Firma		Firma	
Fecha	08/09/2021	Fecha	08/09/2021	Fecha	08/09/2021

INGENIERÍA, MANTENIMIENTO Y EFICIENCIA ENERGÉTICA SPA, RUT: 76.696.552-0, Dirección: Errázuriz #1178, Oficina N° 75, Valparaíso, E-mail: [PATRICIO.FEBRE@IMEE.CL](mailto:PATRICIO.FEBRE@IMEE.CL), Contacto: +56-9-93279529, Sitio Web: [WWW.IMEE.CL](http://WWW.IMEE.CL).

# E.1 INFORME DE ANALISIS Y REPORTE DE MUESTREO COMBUSTIBLE DIÉSEL



## INFORME DE ANALISIS

Nº: LAQ21-1616

Pág 1/1

Fecha de Informe: 01-jul-21  
 Ref. Laboratorio: LAQ21-1616  
 Ref. Operaciones: CLQ21-28382  
 Ref. Cliente: N/A

Cliente:	TECNORED
Dirección:	Cerro El Plomo # 3819, Parque Industrial, Valparaíso
Contacto Cliente:	<a href="mailto:mvasquez@tecnored.cl">mvasquez@tecnored.cl</a>
Descripción Producto (según Cliente):	DIESEL OIL
Lugar de Muestreo (Nave, Terminal, Otro):	SUB ESTACION PLACILLA
Punto de Muestreo:	INICIAL
Condición ambiental:	NORMAL
Tipo de Muestreo:	LINEA
Identificación de Muestra o Sello:	SELLO #111223
Muestreado por y/o plan N°:	INTERTEK CALEB BRETT CHILE S.A. PLAN DE MUESTREO CLQ21-214
Norma Aplicable al muestreo:	API MPMS CAPITULO 8 / ASTM D 4057
Muestra entregada por:	INTERTEK CALEB BRETT CHILE S.A.
Analizada por	INTERTEK CALEB BRETT CHILE S.A. LABORATORY QUINTERO
Fecha de Muestreo	24-Jun-21
Fecha / Hora de Recepción en Lab.	25-Jun-21 12:00 Hrs.
Fecha de Análisis	25-Jun/01-Jul-21

DESCRIPCION DEL ANALISIS	Unidad	Método	Especificación	Resultados
GRAVEDAD API	*API	ASTM D 4052-18a	--	36.4
DENSIDAD A 15°C	kg/L	ASTM D 4052-18a	--	0.8421
PUNTO DE INFLAMACION	°C	ASTM D 93A-18	--	61.0
AZUFRE	% Wt	ASTM D 5453-19a	--	9.3
DESTILACION	--	ASTM D 86-19	--	
PUNTO INICIAL	°C	ASTM D 86-19	--	166.9
50% RECUPERADO	°C	ASTM D 86-19	--	273.9
90% RECUPERADO	°C	ASTM D 86-19	--	341.0
INDICE DE CETANO	N°	ASTM D 976-16	--	51.0
CENIZAS	% Wt	ASTM D 482-19	--	<0.010
AGUA Y SEDIMENTOS	%v/v	ASTM D 2709-16	--	<0.01
CALOR DE COMBUSTION - BRUTO	MJ/Kg	ASTM D 4868-17	--	45.672
CALOR DE COMBUSTION - NETO	MJ/kg	ASTM D 4868-17	--	42.849
INSPECCIÓN VISUAL	--	Visual	--	Claro & Brillante

Rev.11 (09-06-2021)

FCL-Q-008/1 (A)

### Observaciones

A petición del cliente, peso de botella toma de muestra: 469.55g.

- Este reporte de análisis no puede reproducirse parcialmente sin la aprobación por escrito de Intertek Caleb Brett Chile S.A.
- El(los) resultado(s) de ensayo(s) emitido(s) en este Informe es(son) válido(s) únicamente para la muestra descrita.



Acreditado por INN, Acreditación LE 103



Yasna Maureira Campos

Supervisor Laboratorio Combustibles  
Intertek Caleb Brett Chile S.A.

Intertek Caleb Brett Chile S.A.

Oficina Punta Arenas: Avenida España N°142, Punta Arenas

Laboratorio de Combustibles : Ruta F 170 s/n, Las Ventanas V Región - Fonos: (56-32) 279 4371 - Fax: (56-32) 279 4372

Laboratorio Petroquímico : Sanfuentes N° 2318 - San Antonio, Fonos: (56-35) 28 0143, Fax: (56-35) 28 4255

Casa Matriz: Av Las Condes 11287, Torre A Of-301, Las Condes, Santiago - Chile Fonos: (56-2) 24819100 - Fax: (56-2) 24819191 - E-mail: chile.santiago@intertek.com

**SAMPLING REPORT**  
**CLQ21-28382-0001**

According to your instructions, we conducted sampling of the tanks under mentioned, and dispatched to our Installation. Enclosed is ours **Receipt for Samples**, We Trust meets all your requirements.

**1.0 ANTECEDENTS:**

Product (s):  
SHORE TANK: TK-SLOP  
Place of drawn samples: PLANTA TECNO RED PALCILLA VALPARAISO  
Place of delivery samples: PLANTA TECNO RED PLACILLA VALPARAISO  
Date of Samples: Junio 24 th. 2021

**2.0 RECORD OF SAMPLES:**

SIZE OF SAMPLE	POINT	SEAL	DISTIBUTION	SAMPLE TYPE
1LITRO	TK-SLOP	111224	TECNO RED	INICIO PRUEBA
1LITRO	TK-SLOP	124319	TECNO RED	MEDIO PRUEBA
1LITRO	TK-SLOP	138333	TECNO RED	FINAL PRUEBA

- Notes:**
- 2.1 Sampling procedure performed according ASTM / API e Intertek CB.
  - 2.2 containers samples according to client requirement
  - 2.3 Intertek Staff used all PPE for sampling .
  - 2.4 Attached "Receipt for Samples"

**Requested by:** Messrs Tecno Red S.A.

Hector Vilaxa O.  
**Intertek Caleb Brett (Chile) S.A.**

Quintero, Junio 29th, 2021



**Intertek Caleb Brett Chile S.A.**  
Av. Las Condes N° 11287, Torre A, Las Condes, Santiago-Chile  
Teléfono (56-2) 481 9100 – Fax (56-2) 481 5045  
E-mail: [chile.santiago@intertek.com](mailto:chile.santiago@intertek.com)  
[www.intertek-chile.cl](http://www.intertek-chile.cl)

PRODUCTO: DIESEL

DATOS DE MUESTREO

Nombre Cliente:	TECNORFO
Fecha de Visita:	24-04-2024
Ciudad:	Valparaíso Playa Ancha,
Dirección Muestreo:	Av. Obispo Valdeaz S/N

N° Referencia INTERTEK:	CQV-28382
Hora Inicio muestreo:	16:00
Hora Terminó muestreo:	17:00

NUMERO ITEM	IDENTIFICACIÓN PTO. MUESTREO	IDENTIFICACION DEL CILINDRO	PRESION (Bar)	TEMPERATURA AMBIENTE (°C)	HUMEDAD / AGUA LIBRE (GLP)	CILINDRO PARA ENSAYO CONTENIDO DE AZUFRE		SELLO CAJA DE TRANSPORTE
						SI	NO	
I Muestra 1	TK. slop	-	-	-	-	SI	NO <input checked="" type="checkbox"/>	11224
M Muestra 2	TK. slop	-	-	-	-	SI	NO <input checked="" type="checkbox"/>	124319
F Muestra 3	TK. slop	-	-	-	-	SI	NO <input checked="" type="checkbox"/>	130533
Muestra 4						SI	NO <input type="checkbox"/>	
Muestra 5						SI	NO <input type="checkbox"/>	
Muestra 6						SI	NO <input type="checkbox"/>	
Muestra 7						SI	NO <input type="checkbox"/>	
Muestra 8						SI	NO <input type="checkbox"/>	
Muestra 9						SI	NO <input type="checkbox"/>	
Muestra 10						SI	NO <input type="checkbox"/>	
Muestra 11						SI	NO <input type="checkbox"/>	
Muestra 12						SI	NO <input type="checkbox"/>	
Muestra 15						SI	NO <input type="checkbox"/>	

*R. Vera*



*[Signature]*

p. Cliente

E.2 REGISTRO FOTOGRÁFICO DE LA TOMA DE MUESTRA DURANTE LA PRUEBA





	<b>INFORME TÉCNICO DE LA PRUEBA: “POTENCIA MÁXIMA” CENTRAL PLACILLA (revisión 1)</b> Código: PPM-CEN024-2021-CC-DCO-0	
	miércoles 08 septiembre 2021	
Mandante	Revisión 1	Proveedor

## ANEXO F (REGISTRO DE MEDICIONES AMBIENTALES DURANTE LA PRUEBA)

44

Realiza	Francisco Gorigoitia Acuña	Revisa	Patricio Febre Cisternas	Aprueba	Coordinador Eléctrico Nacional
Cargo	Ingeniero de Proyectos	Cargo	Experto Técnico	Cargo	
Firma		Firma		Firma	
Fecha	08/09/2021	Fecha	08/09/2021	Fecha	08/09/2021

INGENIERÍA, MANTENIMIENTO Y EFICIENCIA ENERGÉTICA SPA, RUT: 76.696.552-0, Dirección: Errázuriz #1178, Oficina N° 75, Valparaíso, E-mail: [PATRICIO.FEBRE@IMEE.CL](mailto:PATRICIO.FEBRE@IMEE.CL), Contacto: +56-9-93279529, Sitio Web: [WWW.IMEE.CL](http://WWW.IMEE.CL).

F.1 REGISTRO DE MEDICIONES DE HUMEDAD RELATIVA

Promedio		73,37
Ítem	Fecha y hora	Humedad [%]
1	24-06-2021 10:30	95,00
2	24-06-2021 10:30	95,00
3	24-06-2021 10:30	95,00
4	24-06-2021 10:30	95,00
5	24-06-2021 10:30	95,00
6	24-06-2021 10:30	95,00
7	24-06-2021 10:30	95,00
8	24-06-2021 10:30	95,00
9	24-06-2021 10:30	95,00
10	24-06-2021 10:30	95,00
11	24-06-2021 10:30	95,00
12	24-06-2021 10:30	95,00
13	24-06-2021 10:30	95,00
14	24-06-2021 10:31	95,00
15	24-06-2021 10:31	95,00
16	24-06-2021 10:31	95,00
17	24-06-2021 10:31	95,00
18	24-06-2021 10:31	95,00
19	24-06-2021 10:31	95,00
20	24-06-2021 10:31	95,00
21	24-06-2021 10:31	95,00
22	24-06-2021 10:31	95,00
23	24-06-2021 10:31	95,00
24	24-06-2021 10:31	95,00
25	24-06-2021 10:31	95,00
26	24-06-2021 10:31	95,00
27	24-06-2021 10:31	95,00
28	24-06-2021 10:32	95,00
29	24-06-2021 10:32	95,00
30	24-06-2021 10:32	95,00
31	24-06-2021 10:32	95,00
32	24-06-2021 10:32	95,00
33	24-06-2021 10:32	95,00
34	24-06-2021 10:32	95,00
35	24-06-2021 10:32	95,00
36	24-06-2021 10:32	95,00
37	24-06-2021 10:32	95,00

38	24-06-2021 10:32	95,00
39	24-06-2021 10:32	95,00
40	24-06-2021 10:32	95,00
41	24-06-2021 10:32	95,00
42	24-06-2021 10:33	95,00
43	24-06-2021 10:33	95,00
44	24-06-2021 10:33	95,00
45	24-06-2021 10:33	95,00
46	24-06-2021 10:33	95,00
47	24-06-2021 10:33	95,00
48	24-06-2021 10:33	95,00
49	24-06-2021 10:33	95,00
50	24-06-2021 10:33	95,00
51	24-06-2021 10:33	95,00
52	24-06-2021 10:33	95,00
53	24-06-2021 10:33	95,00
54	24-06-2021 10:33	95,00
55	24-06-2021 10:33	95,00
56	24-06-2021 10:33	95,00
57	24-06-2021 10:33	95,00
58	24-06-2021 10:34	95,00
59	24-06-2021 10:34	95,00
60	24-06-2021 10:34	95,00
61	24-06-2021 10:34	95,00
62	24-06-2021 10:34	95,00
63	24-06-2021 10:34	95,00
64	24-06-2021 10:34	95,00
65	24-06-2021 10:34	95,00
66	24-06-2021 10:34	95,00
67	24-06-2021 10:34	95,00
68	24-06-2021 10:34	95,00
69	24-06-2021 10:34	95,00
70	24-06-2021 10:35	95,00
71	24-06-2021 10:35	95,00
72	24-06-2021 10:35	95,00
73	24-06-2021 10:35	95,00
74	24-06-2021 10:36	95,00
75	24-06-2021 10:36	95,00
76	24-06-2021 10:36	95,00
77	24-06-2021 10:36	95,00
78	24-06-2021 10:36	95,00
79	24-06-2021 10:36	95,00



80	24-06-2021 10:36	95,00
81	24-06-2021 10:36	95,00
82	24-06-2021 10:37	95,00
83	24-06-2021 10:37	95,00
84	24-06-2021 10:37	95,00
85	24-06-2021 10:37	95,00
86	24-06-2021 10:37	95,00
87	24-06-2021 10:37	95,00
88	24-06-2021 10:37	95,00
89	24-06-2021 10:37	95,00
90	24-06-2021 10:37	95,00
91	24-06-2021 10:37	95,00
92	24-06-2021 10:37	95,00
93	24-06-2021 10:37	95,00
94	24-06-2021 10:37	95,00
95	24-06-2021 10:37	95,00
96	24-06-2021 10:37	95,00
97	24-06-2021 10:38	95,00
98	24-06-2021 10:38	95,00
99	24-06-2021 10:38	95,00
100	24-06-2021 10:38	95,00
101	24-06-2021 10:38	95,00
102	24-06-2021 10:39	95,00
103	24-06-2021 10:39	95,00
104	24-06-2021 10:39	95,00
105	24-06-2021 10:39	95,00
106	24-06-2021 10:39	95,00
107	24-06-2021 10:39	95,00
108	24-06-2021 10:39	95,00
109	24-06-2021 10:39	95,00
110	24-06-2021 10:39	95,00
111	24-06-2021 10:39	95,00
112	24-06-2021 10:39	95,00
113	24-06-2021 10:39	95,00
114	24-06-2021 10:39	95,00
115	24-06-2021 10:39	95,00
116	24-06-2021 10:39	95,00
117	24-06-2021 10:39	95,00
118	24-06-2021 10:39	95,00
119	24-06-2021 10:39	95,00
120	24-06-2021 10:39	95,00
121	24-06-2021 10:39	95,00

122	24-06-2021 10:39	95,00
123	24-06-2021 10:39	95,00
124	24-06-2021 10:40	95,00
125	24-06-2021 10:40	95,00
126	24-06-2021 10:40	95,00
127	24-06-2021 10:40	95,00
128	24-06-2021 10:40	95,00
129	24-06-2021 10:40	95,00
130	24-06-2021 10:40	95,00
131	24-06-2021 10:40	95,00
132	24-06-2021 10:40	95,00
133	24-06-2021 10:40	91,00
134	24-06-2021 10:40	91,00
135	24-06-2021 10:40	91,00
136	24-06-2021 10:41	91,00
137	24-06-2021 10:41	91,00
138	24-06-2021 10:41	91,00
139	24-06-2021 10:41	91,00
140	24-06-2021 10:41	91,00
141	24-06-2021 10:41	91,00
142	24-06-2021 10:41	91,00
143	24-06-2021 10:41	91,00
144	24-06-2021 10:41	91,00
145	24-06-2021 10:41	91,00
146	24-06-2021 10:41	91,00
147	24-06-2021 10:41	91,00
148	24-06-2021 10:41	91,00
149	24-06-2021 10:41	89,00
150	24-06-2021 10:41	89,00
151	24-06-2021 10:41	89,00
152	24-06-2021 10:41	89,00
153	24-06-2021 10:42	89,00
154	24-06-2021 10:42	89,00
155	24-06-2021 10:42	89,00
156	24-06-2021 10:42	89,00
157	24-06-2021 10:42	89,00
158	24-06-2021 10:42	89,00
159	24-06-2021 10:42	89,00
160	24-06-2021 10:42	89,00
161	24-06-2021 10:42	88,00
162	24-06-2021 10:42	88,00
163	24-06-2021 10:42	88,00

164	24-06-2021 10:42	88,00
165	24-06-2021 10:42	88,00
166	24-06-2021 10:43	88,00
167	24-06-2021 10:43	88,00
168	24-06-2021 10:43	88,00
169	24-06-2021 10:43	88,00
170	24-06-2021 10:43	87,00
171	24-06-2021 10:43	87,00
172	24-06-2021 10:43	87,00
173	24-06-2021 10:43	87,00
174	24-06-2021 10:43	87,00
175	24-06-2021 10:43	87,00
176	24-06-2021 10:43	87,00
177	24-06-2021 10:43	87,00
178	24-06-2021 10:43	87,00
179	24-06-2021 10:43	87,00
180	24-06-2021 10:43	87,00
181	24-06-2021 10:43	87,00
182	24-06-2021 10:43	87,00
183	24-06-2021 10:43	87,00
184	24-06-2021 10:44	87,00
185	24-06-2021 10:44	87,00
186	24-06-2021 10:44	86,00
187	24-06-2021 10:44	86,00
188	24-06-2021 10:44	86,00
189	24-06-2021 10:44	86,00
190	24-06-2021 10:44	86,00
191	24-06-2021 10:44	86,00
192	24-06-2021 10:44	86,00
193	24-06-2021 10:44	86,00
194	24-06-2021 10:44	86,00
195	24-06-2021 10:44	86,00
196	24-06-2021 10:44	86,00
197	24-06-2021 10:44	86,00
198	24-06-2021 10:45	86,00
199	24-06-2021 10:45	85,00
200	24-06-2021 10:45	85,00
201	24-06-2021 10:45	85,00
202	24-06-2021 10:46	83,00
203	24-06-2021 10:46	83,00
204	24-06-2021 10:46	83,00
205	24-06-2021 10:46	83,00

206	24-06-2021 10:46	83,00
207	24-06-2021 10:46	83,00
208	24-06-2021 10:46	83,00
209	24-06-2021 10:46	83,00
210	24-06-2021 10:46	83,00
211	24-06-2021 10:46	83,00
212	24-06-2021 10:46	83,00
213	24-06-2021 10:46	83,00
214	24-06-2021 10:46	83,00
215	24-06-2021 10:46	83,00
216	24-06-2021 10:46	83,00
217	24-06-2021 10:46	83,00
218	24-06-2021 10:46	82,00
219	24-06-2021 10:46	82,00
220	24-06-2021 10:47	82,00
221	24-06-2021 10:47	82,00
222	24-06-2021 10:47	82,00
223	24-06-2021 10:47	82,00
224	24-06-2021 10:47	82,00
225	24-06-2021 10:47	82,00
226	24-06-2021 10:47	82,00
227	24-06-2021 10:47	82,00
228	24-06-2021 10:47	82,00
229	24-06-2021 10:47	81,00
230	24-06-2021 10:47	81,00
231	24-06-2021 10:47	81,00
232	24-06-2021 10:48	81,00
233	24-06-2021 10:48	81,00
234	24-06-2021 10:48	81,00
235	24-06-2021 10:48	81,00
236	24-06-2021 10:48	81,00
237	24-06-2021 10:48	81,00
238	24-06-2021 10:48	80,00
239	24-06-2021 10:48	80,00
240	24-06-2021 10:48	80,00
241	24-06-2021 10:49	80,00
242	24-06-2021 10:49	80,00
243	24-06-2021 10:49	80,00
244	24-06-2021 10:49	79,00
245	24-06-2021 10:49	79,00
246	24-06-2021 10:49	79,00
247	24-06-2021 10:49	79,00

248	24-06-2021 10:49	79,00
249	24-06-2021 10:49	79,00
250	24-06-2021 10:49	79,00
251	24-06-2021 10:49	79,00
252	24-06-2021 10:50	80,00
253	24-06-2021 10:50	80,00
254	24-06-2021 10:50	80,00
255	24-06-2021 10:50	80,00
256	24-06-2021 10:50	80,00
257	24-06-2021 10:50	80,00
258	24-06-2021 10:50	80,00
259	24-06-2021 10:50	80,00
260	24-06-2021 10:50	80,00
261	24-06-2021 10:50	80,00
262	24-06-2021 10:50	80,00
263	24-06-2021 10:50	80,00
264	24-06-2021 10:50	80,00
265	24-06-2021 10:50	80,00
266	24-06-2021 10:50	80,00
267	24-06-2021 10:50	80,00
268	24-06-2021 10:51	79,00
269	24-06-2021 10:51	79,00
270	24-06-2021 10:51	79,00
271	24-06-2021 10:51	79,00
272	24-06-2021 10:51	79,00
273	24-06-2021 10:51	79,00
274	24-06-2021 10:51	79,00
275	24-06-2021 10:51	79,00
276	24-06-2021 10:51	79,00
277	24-06-2021 10:51	79,00
278	24-06-2021 10:51	79,00
279	24-06-2021 10:51	79,00
280	24-06-2021 10:51	79,00
281	24-06-2021 10:51	79,00
282	24-06-2021 10:51	79,00
283	24-06-2021 10:51	78,00
284	24-06-2021 10:51	78,00
285	24-06-2021 10:52	78,00
286	24-06-2021 10:52	78,00
287	24-06-2021 10:52	78,00
288	24-06-2021 10:52	78,00
289	24-06-2021 10:52	78,00

290	24-06-2021 10:52	78,00
291	24-06-2021 10:52	78,00
292	24-06-2021 10:52	78,00
293	24-06-2021 10:52	78,00
294	24-06-2021 10:52	78,00
295	24-06-2021 10:52	78,00
296	24-06-2021 10:52	78,00
297	24-06-2021 10:52	78,00
298	24-06-2021 10:53	79,00
299	24-06-2021 10:53	79,00
300	24-06-2021 10:53	79,00
301	24-06-2021 10:53	79,00
302	24-06-2021 10:53	79,00
303	24-06-2021 10:53	79,00
304	24-06-2021 10:53	79,00
305	24-06-2021 10:53	79,00
306	24-06-2021 10:53	79,00
307	24-06-2021 10:53	79,00
308	24-06-2021 10:53	79,00
309	24-06-2021 10:53	79,00
310	24-06-2021 10:53	79,00
311	24-06-2021 10:53	79,00
312	24-06-2021 10:53	79,00
313	24-06-2021 10:53	79,00
314	24-06-2021 10:53	79,00
315	24-06-2021 10:53	79,00
316	24-06-2021 10:53	79,00
317	24-06-2021 10:53	79,00
318	24-06-2021 10:53	79,00
319	24-06-2021 10:53	79,00
320	24-06-2021 10:54	79,00
321	24-06-2021 10:54	79,00
322	24-06-2021 10:54	79,00
323	24-06-2021 10:54	79,00
324	24-06-2021 10:54	79,00
325	24-06-2021 10:54	79,00
326	24-06-2021 10:54	79,00
327	24-06-2021 10:54	79,00
328	24-06-2021 10:54	79,00
329	24-06-2021 10:54	79,00
330	24-06-2021 10:54	79,00
331	24-06-2021 10:54	79,00

332	24-06-2021 10:54	79,00
333	24-06-2021 10:54	79,00
334	24-06-2021 10:54	79,00
335	24-06-2021 10:55	79,00
336	24-06-2021 10:55	79,00
337	24-06-2021 10:55	79,00
338	24-06-2021 10:55	79,00
339	24-06-2021 10:55	79,00
340	24-06-2021 10:55	79,00
341	24-06-2021 10:55	78,00
342	24-06-2021 10:55	78,00
343	24-06-2021 10:55	78,00
344	24-06-2021 10:55	78,00
345	24-06-2021 10:55	78,00
346	24-06-2021 10:56	78,00
347	24-06-2021 10:56	78,00
348	24-06-2021 10:56	78,00
349	24-06-2021 10:56	78,00
350	24-06-2021 10:56	78,00
351	24-06-2021 10:56	78,00
352	24-06-2021 10:56	78,00
353	24-06-2021 10:56	78,00
354	24-06-2021 10:56	78,00
355	24-06-2021 10:56	78,00
356	24-06-2021 10:56	78,00
357	24-06-2021 10:56	78,00
358	24-06-2021 10:56	78,00
359	24-06-2021 10:56	78,00
360	24-06-2021 10:56	78,00
361	24-06-2021 10:56	78,00
362	24-06-2021 10:56	78,00
363	24-06-2021 10:56	78,00
364	24-06-2021 10:56	78,00
365	24-06-2021 10:56	78,00
366	24-06-2021 10:57	77,00
367	24-06-2021 10:57	77,00
368	24-06-2021 10:57	77,00
369	24-06-2021 10:57	77,00
370	24-06-2021 10:57	77,00
371	24-06-2021 10:57	77,00
372	24-06-2021 10:57	77,00
373	24-06-2021 10:57	77,00

374	24-06-2021 10:57	77,00
375	24-06-2021 10:57	77,00
376	24-06-2021 10:57	77,00
377	24-06-2021 10:57	77,00
378	24-06-2021 10:57	77,00
379	24-06-2021 10:58	76,00
380	24-06-2021 10:58	76,00
381	24-06-2021 10:58	76,00
382	24-06-2021 10:58	76,00
383	24-06-2021 10:58	76,00
384	24-06-2021 10:58	76,00
385	24-06-2021 10:58	76,00
386	24-06-2021 10:58	76,00
387	24-06-2021 10:58	76,00
388	24-06-2021 10:58	76,00
389	24-06-2021 10:58	76,00
390	24-06-2021 10:59	76,00
391	24-06-2021 10:59	76,00
392	24-06-2021 10:59	76,00
393	24-06-2021 10:59	76,00
394	24-06-2021 10:59	76,00
395	24-06-2021 10:59	76,00
396	24-06-2021 10:59	76,00
397	24-06-2021 10:59	76,00
398	24-06-2021 10:59	76,00
399	24-06-2021 10:59	76,00
400	24-06-2021 10:59	76,00
401	24-06-2021 10:59	76,00
402	24-06-2021 10:59	76,00
403	24-06-2021 10:59	76,00
404	24-06-2021 10:59	76,00
405	24-06-2021 10:59	76,00
406	24-06-2021 10:59	76,00
407	24-06-2021 10:59	76,00
408	24-06-2021 10:59	76,00
409	24-06-2021 11:00	76,00
410	24-06-2021 11:00	76,00
411	24-06-2021 11:00	76,00
412	24-06-2021 11:00	76,00
413	24-06-2021 11:00	76,00
414	24-06-2021 11:00	76,00
415	24-06-2021 11:00	76,00

416	24-06-2021 11:00	76,00
417	24-06-2021 11:00	76,00
418	24-06-2021 11:00	76,00
419	24-06-2021 11:00	76,00
420	24-06-2021 11:00	76,00
421	24-06-2021 11:00	76,00
422	24-06-2021 11:00	76,00
423	24-06-2021 11:00	76,00
424	24-06-2021 11:00	76,00
425	24-06-2021 11:00	76,00
426	24-06-2021 11:00	76,00
427	24-06-2021 11:00	76,00
428	24-06-2021 11:01	76,00
429	24-06-2021 11:01	76,00
430	24-06-2021 11:01	76,00
431	24-06-2021 11:01	76,00
432	24-06-2021 11:01	76,00
433	24-06-2021 11:01	76,00
434	24-06-2021 11:01	76,00
435	24-06-2021 11:01	76,00
436	24-06-2021 11:01	76,00
437	24-06-2021 11:01	76,00
438	24-06-2021 11:01	76,00
439	24-06-2021 11:01	76,00
440	24-06-2021 11:01	76,00
441	24-06-2021 11:01	76,00
442	24-06-2021 11:01	76,00
443	24-06-2021 11:01	76,00
444	24-06-2021 11:01	76,00
445	24-06-2021 11:01	76,00
446	24-06-2021 11:01	76,00
447	24-06-2021 11:01	76,00
448	24-06-2021 11:01	76,00
449	24-06-2021 11:01	76,00
450	24-06-2021 11:01	76,00
451	24-06-2021 11:01	76,00
452	24-06-2021 11:01	76,00
453	24-06-2021 11:02	76,00
454	24-06-2021 11:02	76,00
455	24-06-2021 11:02	75,00
456	24-06-2021 11:02	75,00
457	24-06-2021 11:02	75,00

458	24-06-2021 11:02	75,00
459	24-06-2021 11:02	75,00
460	24-06-2021 11:02	75,00
461	24-06-2021 11:02	75,00
462	24-06-2021 11:02	75,00
463	24-06-2021 11:02	75,00
464	24-06-2021 11:02	75,00
465	24-06-2021 11:02	75,00
466	24-06-2021 11:03	76,00
467	24-06-2021 11:04	76,00
468	24-06-2021 11:04	76,00
469	24-06-2021 11:04	76,00
470	24-06-2021 11:04	76,00
471	24-06-2021 11:04	76,00
472	24-06-2021 11:04	76,00
473	24-06-2021 11:04	76,00
474	24-06-2021 11:04	76,00
475	24-06-2021 11:04	76,00
476	24-06-2021 11:04	76,00
477	24-06-2021 11:04	76,00
478	24-06-2021 11:04	76,00
479	24-06-2021 11:04	76,00
480	24-06-2021 11:04	76,00
481	24-06-2021 11:04	76,00
482	24-06-2021 11:04	76,00
483	24-06-2021 11:04	76,00
484	24-06-2021 11:04	76,00
485	24-06-2021 11:04	75,00
486	24-06-2021 11:04	75,00
487	24-06-2021 11:04	75,00
488	24-06-2021 11:04	75,00
489	24-06-2021 11:04	75,00
490	24-06-2021 11:04	75,00
491	24-06-2021 11:04	75,00
492	24-06-2021 11:04	75,00
493	24-06-2021 11:05	75,00
494	24-06-2021 11:05	75,00
495	24-06-2021 11:05	76,00
496	24-06-2021 11:05	76,00
497	24-06-2021 11:05	76,00
498	24-06-2021 11:05	76,00
499	24-06-2021 11:06	76,00

500	24-06-2021 11:06	76,00
501	24-06-2021 11:06	76,00
502	24-06-2021 11:06	76,00
503	24-06-2021 11:06	76,00
504	24-06-2021 11:06	76,00
505	24-06-2021 11:06	76,00
506	24-06-2021 11:06	76,00
507	24-06-2021 11:06	75,00
508	24-06-2021 11:06	75,00
509	24-06-2021 11:07	74,00
510	24-06-2021 11:07	74,00
511	24-06-2021 11:07	74,00
512	24-06-2021 11:07	74,00
513	24-06-2021 11:07	74,00
514	24-06-2021 11:07	74,00
515	24-06-2021 11:07	74,00
516	24-06-2021 11:07	74,00
517	24-06-2021 11:07	74,00
518	24-06-2021 11:07	74,00
519	24-06-2021 11:08	74,00
520	24-06-2021 11:08	74,00
521	24-06-2021 11:08	74,00
522	24-06-2021 11:08	74,00
523	24-06-2021 11:08	74,00
524	24-06-2021 11:08	74,00
525	24-06-2021 11:08	74,00
526	24-06-2021 11:08	74,00
527	24-06-2021 11:08	74,00
528	24-06-2021 11:08	74,00
529	24-06-2021 11:08	74,00
530	24-06-2021 11:08	74,00
531	24-06-2021 11:08	74,00
532	24-06-2021 11:09	73,00
533	24-06-2021 11:09	73,00
534	24-06-2021 11:09	73,00
535	24-06-2021 11:09	73,00
536	24-06-2021 11:09	73,00
537	24-06-2021 11:09	73,00
538	24-06-2021 11:09	73,00
539	24-06-2021 11:09	73,00
540	24-06-2021 11:09	74,00
541	24-06-2021 11:10	74,00

542	24-06-2021 11:10	74,00
543	24-06-2021 11:10	74,00
544	24-06-2021 11:10	74,00
545	24-06-2021 11:10	74,00
546	24-06-2021 11:10	74,00
547	24-06-2021 11:10	74,00
548	24-06-2021 11:11	73,00
549	24-06-2021 11:11	73,00
550	24-06-2021 11:11	73,00
551	24-06-2021 11:12	73,00
552	24-06-2021 11:12	73,00
553	24-06-2021 11:12	73,00
554	24-06-2021 11:12	73,00
555	24-06-2021 11:12	73,00
556	24-06-2021 11:12	73,00
557	24-06-2021 11:12	73,00
558	24-06-2021 11:12	73,00
559	24-06-2021 11:12	73,00
560	24-06-2021 11:12	73,00
561	24-06-2021 11:12	73,00
562	24-06-2021 11:12	73,00
563	24-06-2021 11:12	73,00
564	24-06-2021 11:12	73,00
565	24-06-2021 11:12	73,00
566	24-06-2021 11:13	73,00
567	24-06-2021 11:13	73,00
568	24-06-2021 11:13	73,00
569	24-06-2021 11:13	73,00
570	24-06-2021 11:13	73,00
571	24-06-2021 11:13	74,00
572	24-06-2021 11:13	74,00
573	24-06-2021 11:13	74,00
574	24-06-2021 11:13	74,00
575	24-06-2021 11:13	74,00
576	24-06-2021 11:13	74,00
577	24-06-2021 11:13	74,00
578	24-06-2021 11:13	74,00
579	24-06-2021 11:13	74,00
580	24-06-2021 11:13	74,00
581	24-06-2021 11:13	74,00
582	24-06-2021 11:13	74,00
583	24-06-2021 11:13	74,00

584	24-06-2021 11:13	74,00
585	24-06-2021 11:13	74,00
586	24-06-2021 11:13	74,00
587	24-06-2021 11:13	74,00
588	24-06-2021 11:13	74,00
589	24-06-2021 11:14	74,00
590	24-06-2021 11:14	73,00
591	24-06-2021 11:14	73,00
592	24-06-2021 11:14	73,00
593	24-06-2021 11:14	73,00
594	24-06-2021 11:14	73,00
595	24-06-2021 11:14	73,00
596	24-06-2021 11:15	73,00
597	24-06-2021 11:15	73,00
598	24-06-2021 11:15	73,00
599	24-06-2021 11:15	73,00
600	24-06-2021 11:15	73,00
601	24-06-2021 11:15	73,00
602	24-06-2021 11:15	73,00
603	24-06-2021 11:15	73,00
604	24-06-2021 11:15	73,00
605	24-06-2021 11:15	73,00
606	24-06-2021 11:15	73,00
607	24-06-2021 11:15	73,00
608	24-06-2021 11:15	73,00
609	24-06-2021 11:15	72,00
610	24-06-2021 11:16	72,00
611	24-06-2021 11:16	72,00
612	24-06-2021 11:16	72,00
613	24-06-2021 11:16	72,00
614	24-06-2021 11:16	72,00
615	24-06-2021 11:16	72,00
616	24-06-2021 11:16	72,00
617	24-06-2021 11:16	72,00
618	24-06-2021 11:16	72,00
619	24-06-2021 11:16	72,00
620	24-06-2021 11:16	72,00
621	24-06-2021 11:16	72,00
622	24-06-2021 11:16	72,00
623	24-06-2021 11:16	72,00
624	24-06-2021 11:16	72,00
625	24-06-2021 11:16	72,00

626	24-06-2021 11:16	72,00
627	24-06-2021 11:17	72,00
628	24-06-2021 11:17	72,00
629	24-06-2021 11:17	72,00
630	24-06-2021 11:17	72,00
631	24-06-2021 11:17	72,00
632	24-06-2021 11:17	72,00
633	24-06-2021 11:17	72,00
634	24-06-2021 11:17	72,00
635	24-06-2021 11:17	72,00
636	24-06-2021 11:17	72,00
637	24-06-2021 11:17	72,00
638	24-06-2021 11:17	73,00
639	24-06-2021 11:17	73,00
640	24-06-2021 11:17	73,00
641	24-06-2021 11:17	73,00
642	24-06-2021 11:17	73,00
643	24-06-2021 11:17	73,00
644	24-06-2021 11:17	73,00
645	24-06-2021 11:17	73,00
646	24-06-2021 11:18	73,00
647	24-06-2021 11:18	73,00
648	24-06-2021 11:18	73,00
649	24-06-2021 11:18	73,00
650	24-06-2021 11:18	73,00
651	24-06-2021 11:18	73,00
652	24-06-2021 11:18	73,00
653	24-06-2021 11:18	73,00
654	24-06-2021 11:18	73,00
655	24-06-2021 11:18	73,00
656	24-06-2021 11:18	73,00
657	24-06-2021 11:18	73,00
658	24-06-2021 11:18	73,00
659	24-06-2021 11:18	73,00
660	24-06-2021 11:18	73,00
661	24-06-2021 11:18	73,00
662	24-06-2021 11:18	73,00
663	24-06-2021 11:18	73,00
664	24-06-2021 11:18	73,00
665	24-06-2021 11:18	73,00
666	24-06-2021 11:18	73,00
667	24-06-2021 11:19	73,00

668	24-06-2021 11:19	73,00
669	24-06-2021 11:19	73,00
670	24-06-2021 11:19	73,00
671	24-06-2021 11:19	72,00
672	24-06-2021 11:20	73,00
673	24-06-2021 11:20	73,00
674	24-06-2021 11:20	73,00
675	24-06-2021 11:20	73,00
676	24-06-2021 11:20	73,00
677	24-06-2021 11:20	73,00
678	24-06-2021 11:20	73,00
679	24-06-2021 11:20	73,00
680	24-06-2021 11:20	73,00
681	24-06-2021 11:20	73,00
682	24-06-2021 11:20	73,00
683	24-06-2021 11:21	73,00
684	24-06-2021 11:21	73,00
685	24-06-2021 11:21	73,00
686	24-06-2021 11:21	73,00
687	24-06-2021 11:21	73,00
688	24-06-2021 11:21	73,00
689	24-06-2021 11:21	73,00
690	24-06-2021 11:22	73,00
691	24-06-2021 11:22	73,00
692	24-06-2021 11:22	73,00
693	24-06-2021 11:22	73,00
694	24-06-2021 11:22	73,00
695	24-06-2021 11:22	73,00
696	24-06-2021 11:22	73,00
697	24-06-2021 11:22	73,00
698	24-06-2021 11:23	73,00
699	24-06-2021 11:23	73,00
700	24-06-2021 11:23	73,00
701	24-06-2021 11:23	73,00
702	24-06-2021 11:23	73,00
703	24-06-2021 11:23	73,00
704	24-06-2021 11:23	73,00
705	24-06-2021 11:23	73,00
706	24-06-2021 11:23	73,00
707	24-06-2021 11:23	72,00
708	24-06-2021 11:23	72,00
709	24-06-2021 11:23	72,00

710	24-06-2021 11:23	72,00
711	24-06-2021 11:23	72,00
712	24-06-2021 11:23	72,00
713	24-06-2021 11:23	72,00
714	24-06-2021 11:24	72,00
715	24-06-2021 11:24	72,00
716	24-06-2021 11:24	72,00
717	24-06-2021 11:24	72,00
718	24-06-2021 11:24	72,00
719	24-06-2021 11:24	72,00
720	24-06-2021 11:24	72,00
721	24-06-2021 11:24	72,00
722	24-06-2021 11:24	72,00
723	24-06-2021 11:24	72,00
724	24-06-2021 11:24	71,00
725	24-06-2021 11:24	71,00
726	24-06-2021 11:24	71,00
727	24-06-2021 11:24	71,00
728	24-06-2021 11:24	71,00
729	24-06-2021 11:24	71,00
730	24-06-2021 11:24	71,00
731	24-06-2021 11:24	71,00
732	24-06-2021 11:24	71,00
733	24-06-2021 11:24	71,00
734	24-06-2021 11:24	71,00
735	24-06-2021 11:24	71,00
736	24-06-2021 11:24	71,00
737	24-06-2021 11:24	71,00
738	24-06-2021 11:24	71,00
739	24-06-2021 11:24	71,00
740	24-06-2021 11:25	71,00
741	24-06-2021 11:25	71,00
742	24-06-2021 11:25	71,00
743	24-06-2021 11:25	71,00
744	24-06-2021 11:25	71,00
745	24-06-2021 11:25	71,00
746	24-06-2021 11:25	70,00
747	24-06-2021 11:26	70,00
748	24-06-2021 11:26	70,00
749	24-06-2021 11:26	70,00
750	24-06-2021 11:26	70,00
751	24-06-2021 11:26	70,00



752	24-06-2021 11:26	70,00
753	24-06-2021 11:26	70,00
754	24-06-2021 11:26	70,00
755	24-06-2021 11:26	70,00
756	24-06-2021 11:26	70,00
757	24-06-2021 11:26	70,00
758	24-06-2021 11:26	70,00
759	24-06-2021 11:26	70,00
760	24-06-2021 11:26	70,00
761	24-06-2021 11:26	70,00
762	24-06-2021 11:26	70,00
763	24-06-2021 11:26	70,00
764	24-06-2021 11:26	70,00
765	24-06-2021 11:27	69,00
766	24-06-2021 11:27	69,00
767	24-06-2021 11:27	69,00
768	24-06-2021 11:27	69,00
769	24-06-2021 11:27	69,00
770	24-06-2021 11:27	69,00
771	24-06-2021 11:27	69,00
772	24-06-2021 11:27	69,00
773	24-06-2021 11:27	69,00
774	24-06-2021 11:27	69,00
775	24-06-2021 11:27	69,00
776	24-06-2021 11:27	69,00
777	24-06-2021 11:27	69,00
778	24-06-2021 11:27	69,00
779	24-06-2021 11:27	69,00
780	24-06-2021 11:27	70,00
781	24-06-2021 11:27	70,00
782	24-06-2021 11:27	70,00
783	24-06-2021 11:27	70,00
784	24-06-2021 11:28	70,00
785	24-06-2021 11:28	70,00
786	24-06-2021 11:28	70,00
787	24-06-2021 11:28	70,00
788	24-06-2021 11:28	70,00
789	24-06-2021 11:28	70,00
790	24-06-2021 11:28	70,00
791	24-06-2021 11:28	70,00
792	24-06-2021 11:28	70,00
793	24-06-2021 11:28	70,00

794	24-06-2021 11:28	70,00
795	24-06-2021 11:28	70,00
796	24-06-2021 11:28	70,00
797	24-06-2021 11:28	70,00
798	24-06-2021 11:28	69,00
799	24-06-2021 11:28	69,00
800	24-06-2021 11:28	69,00
801	24-06-2021 11:28	69,00
802	24-06-2021 11:28	69,00
803	24-06-2021 11:28	69,00
804	24-06-2021 11:28	69,00
805	24-06-2021 11:29	69,00
806	24-06-2021 11:29	69,00
807	24-06-2021 11:29	69,00
808	24-06-2021 11:29	69,00
809	24-06-2021 11:29	69,00
810	24-06-2021 11:29	69,00
811	24-06-2021 11:29	69,00
812	24-06-2021 11:29	69,00
813	24-06-2021 11:29	69,00
814	24-06-2021 11:29	69,00
815	24-06-2021 11:29	69,00
816	24-06-2021 11:29	69,00
817	24-06-2021 11:29	69,00
818	24-06-2021 11:29	69,00
819	24-06-2021 11:29	69,00
820	24-06-2021 11:29	69,00
821	24-06-2021 11:30	69,00
822	24-06-2021 11:30	69,00
823	24-06-2021 11:30	69,00
824	24-06-2021 11:30	69,00
825	24-06-2021 11:30	69,00
826	24-06-2021 11:30	69,00
827	24-06-2021 11:30	69,00
828	24-06-2021 11:30	69,00
829	24-06-2021 11:30	69,00
830	24-06-2021 11:30	69,00
831	24-06-2021 11:30	69,00
832	24-06-2021 11:30	69,00
833	24-06-2021 11:30	69,00
834	24-06-2021 11:30	69,00
835	24-06-2021 11:30	69,00

836	24-06-2021 11:30	69,00
837	24-06-2021 11:30	69,00
838	24-06-2021 11:30	69,00
839	24-06-2021 11:30	69,00
840	24-06-2021 11:30	69,00
841	24-06-2021 11:30	69,00
842	24-06-2021 11:30	69,00
843	24-06-2021 11:30	69,00
844	24-06-2021 11:31	69,00
845	24-06-2021 11:31	69,00
846	24-06-2021 11:31	69,00
847	24-06-2021 11:31	69,00
848	24-06-2021 11:31	69,00
849	24-06-2021 11:31	69,00
850	24-06-2021 11:31	69,00
851	24-06-2021 11:31	69,00
852	24-06-2021 11:31	69,00
853	24-06-2021 11:31	69,00
854	24-06-2021 11:31	69,00
855	24-06-2021 11:31	69,00
856	24-06-2021 11:31	69,00
857	24-06-2021 11:31	69,00
858	24-06-2021 11:31	69,00
859	24-06-2021 11:31	69,00
860	24-06-2021 11:32	69,00
861	24-06-2021 11:32	69,00
862	24-06-2021 11:32	70,00
863	24-06-2021 11:32	70,00
864	24-06-2021 11:32	70,00
865	24-06-2021 11:32	70,00
866	24-06-2021 11:32	70,00
867	24-06-2021 11:32	70,00
868	24-06-2021 11:32	70,00
869	24-06-2021 11:32	70,00
870	24-06-2021 11:32	70,00
871	24-06-2021 11:33	68,00
872	24-06-2021 11:33	68,00
873	24-06-2021 11:33	68,00
874	24-06-2021 11:33	68,00
875	24-06-2021 11:33	68,00
876	24-06-2021 11:33	68,00
877	24-06-2021 11:33	68,00

878	24-06-2021 11:34	68,00
879	24-06-2021 11:34	68,00
880	24-06-2021 11:34	68,00
881	24-06-2021 11:34	68,00
882	24-06-2021 11:34	68,00
883	24-06-2021 11:34	68,00
884	24-06-2021 11:34	68,00
885	24-06-2021 11:34	68,00
886	24-06-2021 11:34	68,00
887	24-06-2021 11:34	69,00
888	24-06-2021 11:34	69,00
889	24-06-2021 11:35	69,00
890	24-06-2021 11:35	69,00
891	24-06-2021 11:35	69,00
892	24-06-2021 11:35	69,00
893	24-06-2021 11:35	69,00
894	24-06-2021 11:35	69,00
895	24-06-2021 11:36	69,00
896	24-06-2021 11:36	69,00
897	24-06-2021 11:36	69,00
898	24-06-2021 11:36	69,00
899	24-06-2021 11:36	69,00
900	24-06-2021 11:36	69,00
901	24-06-2021 11:36	69,00
902	24-06-2021 11:36	69,00
903	24-06-2021 11:36	69,00
904	24-06-2021 11:39	71,00
905	24-06-2021 11:39	71,00
906	24-06-2021 11:39	71,00
907	24-06-2021 11:39	71,00
908	24-06-2021 11:39	70,00
909	24-06-2021 11:39	70,00
910	24-06-2021 11:39	70,00
911	24-06-2021 11:40	70,00
912	24-06-2021 11:40	70,00
913	24-06-2021 11:40	70,00
914	24-06-2021 11:40	70,00
915	24-06-2021 11:40	70,00
916	24-06-2021 11:40	70,00
917	24-06-2021 11:40	70,00
918	24-06-2021 11:40	70,00
919	24-06-2021 11:40	70,00

920	24-06-2021 11:40	70,00
921	24-06-2021 11:40	70,00
922	24-06-2021 11:40	70,00
923	24-06-2021 11:40	70,00
924	24-06-2021 11:40	70,00
925	24-06-2021 11:40	70,00
926	24-06-2021 11:40	70,00
927	24-06-2021 11:40	70,00
928	24-06-2021 11:40	70,00
929	24-06-2021 11:40	70,00
930	24-06-2021 11:40	70,00
931	24-06-2021 11:40	70,00
932	24-06-2021 11:40	70,00
933	24-06-2021 11:40	70,00
934	24-06-2021 11:40	70,00
935	24-06-2021 11:40	70,00
936	24-06-2021 11:41	70,00
937	24-06-2021 11:41	70,00
938	24-06-2021 11:41	70,00
939	24-06-2021 11:42	70,00
940	24-06-2021 11:42	70,00
941	24-06-2021 11:42	70,00
942	24-06-2021 11:42	71,00
943	24-06-2021 11:42	71,00
944	24-06-2021 11:42	71,00
945	24-06-2021 11:42	71,00
946	24-06-2021 11:42	71,00
947	24-06-2021 11:42	71,00
948	24-06-2021 11:42	71,00
949	24-06-2021 11:42	71,00
950	24-06-2021 11:42	71,00
951	24-06-2021 11:42	71,00
952	24-06-2021 11:42	71,00
953	24-06-2021 11:42	71,00
954	24-06-2021 11:43	71,00
955	24-06-2021 11:43	71,00
956	24-06-2021 11:43	71,00
957	24-06-2021 11:43	72,00
958	24-06-2021 11:43	72,00
959	24-06-2021 11:43	72,00
960	24-06-2021 11:43	72,00
961	24-06-2021 11:43	72,00

962	24-06-2021 11:43	72,00
963	24-06-2021 11:43	72,00
964	24-06-2021 11:43	72,00
965	24-06-2021 11:43	72,00
966	24-06-2021 11:43	72,00
967	24-06-2021 11:43	72,00
968	24-06-2021 11:43	72,00
969	24-06-2021 11:43	72,00
970	24-06-2021 11:43	72,00
971	24-06-2021 11:44	71,00
972	24-06-2021 11:44	71,00
973	24-06-2021 11:44	71,00
974	24-06-2021 11:44	71,00
975	24-06-2021 11:44	71,00
976	24-06-2021 11:44	71,00
977	24-06-2021 11:44	71,00
978	24-06-2021 11:44	71,00
979	24-06-2021 11:44	71,00
980	24-06-2021 11:44	71,00
981	24-06-2021 11:45	71,00
982	24-06-2021 11:45	71,00
983	24-06-2021 11:45	71,00
984	24-06-2021 11:45	71,00
985	24-06-2021 11:45	71,00
986	24-06-2021 11:45	71,00
987	24-06-2021 11:45	71,00
988	24-06-2021 11:45	71,00
989	24-06-2021 11:45	71,00
990	24-06-2021 11:45	71,00
991	24-06-2021 11:45	71,00
992	24-06-2021 11:45	71,00
993	24-06-2021 11:45	71,00
994	24-06-2021 11:45	70,00
995	24-06-2021 11:45	70,00
996	24-06-2021 11:45	70,00
997	24-06-2021 11:45	70,00
998	24-06-2021 11:45	70,00
999	24-06-2021 11:46	70,00
1000	24-06-2021 11:46	70,00
1001	24-06-2021 11:46	70,00
1002	24-06-2021 11:46	70,00
1003	24-06-2021 11:46	70,00

1004	24-06-2021 11:46	70,00
1005	24-06-2021 11:46	70,00
1006	24-06-2021 11:47	66,00
1007	24-06-2021 11:47	66,00
1008	24-06-2021 11:47	66,00
1009	24-06-2021 11:47	66,00
1010	24-06-2021 11:47	66,00
1011	24-06-2021 11:47	66,00
1012	24-06-2021 11:47	66,00
1013	24-06-2021 11:47	66,00
1014	24-06-2021 11:47	66,00
1015	24-06-2021 11:47	66,00
1016	24-06-2021 11:47	66,00
1017	24-06-2021 11:47	66,00
1018	24-06-2021 11:48	64,00
1019	24-06-2021 11:48	64,00
1020	24-06-2021 11:48	64,00
1021	24-06-2021 11:48	64,00
1022	24-06-2021 11:48	64,00
1023	24-06-2021 11:48	64,00
1024	24-06-2021 11:48	64,00
1025	24-06-2021 11:48	64,00
1026	24-06-2021 11:48	64,00
1027	24-06-2021 11:48	64,00
1028	24-06-2021 11:49	64,00
1029	24-06-2021 11:49	64,00
1030	24-06-2021 11:49	64,00
1031	24-06-2021 11:49	64,00
1032	24-06-2021 11:49	64,00
1033	24-06-2021 11:49	64,00
1034	24-06-2021 11:50	65,00
1035	24-06-2021 11:50	65,00
1036	24-06-2021 11:50	65,00
1037	24-06-2021 11:50	65,00
1038	24-06-2021 11:50	65,00
1039	24-06-2021 11:50	65,00
1040	24-06-2021 11:50	65,00
1041	24-06-2021 11:50	65,00
1042	24-06-2021 11:51	65,00
1043	24-06-2021 11:51	65,00
1044	24-06-2021 11:51	65,00
1045	24-06-2021 11:51	65,00

1046	24-06-2021 11:51	65,00
1047	24-06-2021 11:51	65,00
1048	24-06-2021 11:51	65,00
1049	24-06-2021 11:51	65,00
1050	24-06-2021 11:51	65,00
1051	24-06-2021 11:51	65,00
1052	24-06-2021 11:51	65,00
1053	24-06-2021 11:51	65,00
1054	24-06-2021 11:51	66,00
1055	24-06-2021 11:51	66,00
1056	24-06-2021 11:51	66,00
1057	24-06-2021 11:51	66,00
1058	24-06-2021 11:52	66,00
1059	24-06-2021 11:52	66,00
1060	24-06-2021 11:52	66,00
1061	24-06-2021 11:52	66,00
1062	24-06-2021 11:52	66,00
1063	24-06-2021 11:52	66,00
1064	24-06-2021 11:52	66,00
1065	24-06-2021 11:52	66,00
1066	24-06-2021 11:52	66,00
1067	24-06-2021 11:52	66,00
1068	24-06-2021 11:52	66,00
1069	24-06-2021 11:52	67,00
1070	24-06-2021 11:52	67,00
1071	24-06-2021 11:52	67,00
1072	24-06-2021 11:52	67,00
1073	24-06-2021 11:52	67,00
1074	24-06-2021 11:52	67,00
1075	24-06-2021 11:53	67,00
1076	24-06-2021 11:53	67,00
1077	24-06-2021 11:53	67,00
1078	24-06-2021 11:53	67,00
1079	24-06-2021 11:53	69,00
1080	24-06-2021 11:53	69,00
1081	24-06-2021 11:54	69,00
1082	24-06-2021 11:54	69,00
1083	24-06-2021 11:54	69,00
1084	24-06-2021 11:54	69,00
1085	24-06-2021 11:54	69,00
1086	24-06-2021 11:54	69,00
1087	24-06-2021 11:54	70,00

1088	24-06-2021 11:54	70,00
1089	24-06-2021 11:54	70,00
1090	24-06-2021 11:54	70,00
1091	24-06-2021 11:54	70,00
1092	24-06-2021 11:54	70,00
1093	24-06-2021 11:54	70,00
1094	24-06-2021 11:54	70,00
1095	24-06-2021 11:54	70,00
1096	24-06-2021 11:55	70,00
1097	24-06-2021 11:55	70,00
1098	24-06-2021 11:55	70,00
1099	24-06-2021 11:55	70,00
1100	24-06-2021 11:55	70,00
1101	24-06-2021 11:55	70,00
1102	24-06-2021 11:55	70,00
1103	24-06-2021 11:55	70,00
1104	24-06-2021 11:55	70,00
1105	24-06-2021 11:55	70,00
1106	24-06-2021 11:55	70,00
1107	24-06-2021 11:56	71,00
1108	24-06-2021 11:56	71,00
1109	24-06-2021 11:56	71,00
1110	24-06-2021 11:56	71,00
1111	24-06-2021 11:57	71,00
1112	24-06-2021 11:57	71,00
1113	24-06-2021 11:57	71,00
1114	24-06-2021 11:57	71,00
1115	24-06-2021 11:57	71,00
1116	24-06-2021 11:57	71,00
1117	24-06-2021 11:57	71,00
1118	24-06-2021 11:57	71,00
1119	24-06-2021 11:57	71,00
1120	24-06-2021 11:57	71,00
1121	24-06-2021 11:57	71,00
1122	24-06-2021 11:57	71,00
1123	24-06-2021 11:57	71,00
1124	24-06-2021 11:58	71,00
1125	24-06-2021 11:58	71,00
1126	24-06-2021 11:58	71,00
1127	24-06-2021 11:58	71,00
1128	24-06-2021 11:58	71,00
1129	24-06-2021 11:58	70,00

1130	24-06-2021 11:58	70,00
1131	24-06-2021 11:58	70,00
1132	24-06-2021 11:58	70,00
1133	24-06-2021 11:58	70,00
1134	24-06-2021 11:58	70,00
1135	24-06-2021 11:58	70,00
1136	24-06-2021 11:58	70,00
1137	24-06-2021 11:58	70,00
1138	24-06-2021 11:58	70,00
1139	24-06-2021 11:59	71,00
1140	24-06-2021 11:59	71,00
1141	24-06-2021 11:59	71,00
1142	24-06-2021 11:59	71,00
1143	24-06-2021 11:59	71,00
1144	24-06-2021 11:59	71,00
1145	24-06-2021 11:59	71,00
1146	24-06-2021 11:59	71,00
1147	24-06-2021 12:00	71,00
1148	24-06-2021 12:00	71,00
1149	24-06-2021 12:00	71,00
1150	24-06-2021 12:00	71,00
1151	24-06-2021 12:00	71,00
1152	24-06-2021 12:00	71,00
1153	24-06-2021 12:00	72,00
1154	24-06-2021 12:00	72,00
1155	24-06-2021 12:00	72,00
1156	24-06-2021 12:00	72,00
1157	24-06-2021 12:00	72,00
1158	24-06-2021 12:00	72,00
1159	24-06-2021 12:00	72,00
1160	24-06-2021 12:00	72,00
1161	24-06-2021 12:00	72,00
1162	24-06-2021 12:00	72,00
1163	24-06-2021 12:00	72,00
1164	24-06-2021 12:01	72,00
1165	24-06-2021 12:01	72,00
1166	24-06-2021 12:01	72,00
1167	24-06-2021 12:01	72,00
1168	24-06-2021 12:01	72,00
1169	24-06-2021 12:01	72,00
1170	24-06-2021 12:01	72,00
1171	24-06-2021 12:01	72,00

1172	24-06-2021 12:01	72,00
1173	24-06-2021 12:01	72,00
1174	24-06-2021 12:01	72,00
1175	24-06-2021 12:01	72,00
1176	24-06-2021 12:01	73,00
1177	24-06-2021 12:02	73,00
1178	24-06-2021 12:02	73,00
1179	24-06-2021 12:02	73,00
1180	24-06-2021 12:02	73,00
1181	24-06-2021 12:02	73,00
1182	24-06-2021 12:02	73,00
1183	24-06-2021 12:02	73,00
1184	24-06-2021 12:02	73,00
1185	24-06-2021 12:02	73,00
1186	24-06-2021 12:03	74,00
1187	24-06-2021 12:03	74,00
1188	24-06-2021 12:03	74,00
1189	24-06-2021 12:03	74,00
1190	24-06-2021 12:03	74,00
1191	24-06-2021 12:03	74,00
1192	24-06-2021 12:03	74,00
1193	24-06-2021 12:03	74,00
1194	24-06-2021 12:03	74,00
1195	24-06-2021 12:03	73,00
1196	24-06-2021 12:03	73,00
1197	24-06-2021 12:03	73,00
1198	24-06-2021 12:03	73,00
1199	24-06-2021 12:03	73,00
1200	24-06-2021 12:04	73,00
1201	24-06-2021 12:04	73,00
1202	24-06-2021 12:04	73,00
1203	24-06-2021 12:04	73,00
1204	24-06-2021 12:04	73,00
1205	24-06-2021 12:04	73,00
1206	24-06-2021 12:04	73,00
1207	24-06-2021 12:04	73,00
1208	24-06-2021 12:04	73,00
1209	24-06-2021 12:04	73,00
1210	24-06-2021 12:04	73,00
1211	24-06-2021 12:04	73,00
1212	24-06-2021 12:05	73,00
1213	24-06-2021 12:05	73,00

1214	24-06-2021 12:05	73,00
1215	24-06-2021 12:05	73,00
1216	24-06-2021 12:05	73,00
1217	24-06-2021 12:05	73,00
1218	24-06-2021 12:05	73,00
1219	24-06-2021 12:05	73,00
1220	24-06-2021 12:05	73,00
1221	24-06-2021 12:05	73,00
1222	24-06-2021 12:05	73,00
1223	24-06-2021 12:05	73,00
1224	24-06-2021 12:06	73,00
1225	24-06-2021 12:06	73,00
1226	24-06-2021 12:06	73,00
1227	24-06-2021 12:06	73,00
1228	24-06-2021 12:06	74,00
1229	24-06-2021 12:06	74,00
1230	24-06-2021 12:06	74,00
1231	24-06-2021 12:06	74,00
1232	24-06-2021 12:06	74,00
1233	24-06-2021 12:06	74,00
1234	24-06-2021 12:06	74,00
1235	24-06-2021 12:06	74,00
1236	24-06-2021 12:07	74,00
1237	24-06-2021 12:07	74,00
1238	24-06-2021 12:07	74,00
1239	24-06-2021 12:07	74,00
1240	24-06-2021 12:07	74,00
1241	24-06-2021 12:07	74,00
1242	24-06-2021 12:07	74,00
1243	24-06-2021 12:07	74,00
1244	24-06-2021 12:07	74,00
1245	24-06-2021 12:07	74,00
1246	24-06-2021 12:08	74,00
1247	24-06-2021 12:08	74,00
1248	24-06-2021 12:08	74,00
1249	24-06-2021 12:08	74,00
1250	24-06-2021 12:08	74,00
1251	24-06-2021 12:08	74,00
1252	24-06-2021 12:08	74,00
1253	24-06-2021 12:08	74,00
1254	24-06-2021 12:08	74,00
1255	24-06-2021 12:08	74,00

1256	24-06-2021 12:08	74,00
1257	24-06-2021 12:08	74,00
1258	24-06-2021 12:08	74,00
1259	24-06-2021 12:08	74,00
1260	24-06-2021 12:08	74,00
1261	24-06-2021 12:09	74,00
1262	24-06-2021 12:09	74,00
1263	24-06-2021 12:09	74,00
1264	24-06-2021 12:09	74,00
1265	24-06-2021 12:09	74,00
1266	24-06-2021 12:09	74,00
1267	24-06-2021 12:09	74,00
1268	24-06-2021 12:09	74,00
1269	24-06-2021 12:09	74,00
1270	24-06-2021 12:09	73,00
1271	24-06-2021 12:09	73,00
1272	24-06-2021 12:09	73,00
1273	24-06-2021 12:09	73,00
1274	24-06-2021 12:09	73,00
1275	24-06-2021 12:10	73,00
1276	24-06-2021 12:10	73,00
1277	24-06-2021 12:10	73,00
1278	24-06-2021 12:10	73,00
1279	24-06-2021 12:10	73,00
1280	24-06-2021 12:10	73,00
1281	24-06-2021 12:10	73,00
1282	24-06-2021 12:10	73,00
1283	24-06-2021 12:10	73,00
1284	24-06-2021 12:10	73,00
1285	24-06-2021 12:11	73,00
1286	24-06-2021 12:11	73,00
1287	24-06-2021 12:11	73,00
1288	24-06-2021 12:11	73,00
1289	24-06-2021 12:11	73,00
1290	24-06-2021 12:11	73,00
1291	24-06-2021 12:11	73,00
1292	24-06-2021 12:11	74,00
1293	24-06-2021 12:11	74,00
1294	24-06-2021 12:11	74,00
1295	24-06-2021 12:11	74,00
1296	24-06-2021 12:11	74,00
1297	24-06-2021 12:11	74,00

1298	24-06-2021 12:11	74,00
1299	24-06-2021 12:11	74,00
1300	24-06-2021 12:11	74,00
1301	24-06-2021 12:11	74,00
1302	24-06-2021 12:11	74,00
1303	24-06-2021 12:11	74,00
1304	24-06-2021 12:11	74,00
1305	24-06-2021 12:11	74,00
1306	24-06-2021 12:12	74,00
1307	24-06-2021 12:12	74,00
1308	24-06-2021 12:12	74,00
1309	24-06-2021 12:12	74,00
1310	24-06-2021 12:12	73,00
1311	24-06-2021 12:12	73,00
1312	24-06-2021 12:12	73,00
1313	24-06-2021 12:12	73,00
1314	24-06-2021 12:12	73,00
1315	24-06-2021 12:12	73,00
1316	24-06-2021 12:12	73,00
1317	24-06-2021 12:12	73,00
1318	24-06-2021 12:13	73,00
1319	24-06-2021 12:13	73,00
1320	24-06-2021 12:13	73,00
1321	24-06-2021 12:13	73,00
1322	24-06-2021 12:13	73,00
1323	24-06-2021 12:13	73,00
1324	24-06-2021 12:13	75,00
1325	24-06-2021 12:14	75,00
1326	24-06-2021 12:14	75,00
1327	24-06-2021 12:14	75,00
1328	24-06-2021 12:14	75,00
1329	24-06-2021 12:14	75,00
1330	24-06-2021 12:14	75,00
1331	24-06-2021 12:14	75,00
1332	24-06-2021 12:14	75,00
1333	24-06-2021 12:14	75,00
1334	24-06-2021 12:14	74,00
1335	24-06-2021 12:14	74,00
1336	24-06-2021 12:15	74,00
1337	24-06-2021 12:15	74,00
1338	24-06-2021 12:15	74,00
1339	24-06-2021 12:15	74,00

1340	24-06-2021 12:15	74,00
1341	24-06-2021 12:15	74,00
1342	24-06-2021 12:15	74,00
1343	24-06-2021 12:15	74,00
1344	24-06-2021 12:15	74,00
1345	24-06-2021 12:15	74,00
1346	24-06-2021 12:15	74,00
1347	24-06-2021 12:15	74,00
1348	24-06-2021 12:15	74,00
1349	24-06-2021 12:15	74,00
1350	24-06-2021 12:15	74,00
1351	24-06-2021 12:16	74,00
1352	24-06-2021 12:16	74,00
1353	24-06-2021 12:16	74,00
1354	24-06-2021 12:16	74,00
1355	24-06-2021 12:16	74,00
1356	24-06-2021 12:16	74,00
1357	24-06-2021 12:16	74,00
1358	24-06-2021 12:16	74,00
1359	24-06-2021 12:16	74,00
1360	24-06-2021 12:16	74,00
1361	24-06-2021 12:16	74,00
1362	24-06-2021 12:16	74,00
1363	24-06-2021 12:16	74,00
1364	24-06-2021 12:16	74,00
1365	24-06-2021 12:16	74,00
1366	24-06-2021 12:17	74,00
1367	24-06-2021 12:17	74,00
1368	24-06-2021 12:17	74,00
1369	24-06-2021 12:17	74,00
1370	24-06-2021 12:17	74,00
1371	24-06-2021 12:17	74,00
1372	24-06-2021 12:17	74,00
1373	24-06-2021 12:17	74,00
1374	24-06-2021 12:17	74,00
1375	24-06-2021 12:17	74,00
1376	24-06-2021 12:17	74,00
1377	24-06-2021 12:17	74,00
1378	24-06-2021 12:17	74,00
1379	24-06-2021 12:17	74,00
1380	24-06-2021 12:18	74,00
1381	24-06-2021 12:18	74,00

1382	24-06-2021 12:18	74,00
1383	24-06-2021 12:18	73,00
1384	24-06-2021 12:18	73,00
1385	24-06-2021 12:18	73,00
1386	24-06-2021 12:18	73,00
1387	24-06-2021 12:18	73,00
1388	24-06-2021 12:18	73,00
1389	24-06-2021 12:18	73,00
1390	24-06-2021 12:18	73,00
1391	24-06-2021 12:18	73,00
1392	24-06-2021 12:18	73,00
1393	24-06-2021 12:18	73,00
1394	24-06-2021 12:18	73,00
1395	24-06-2021 12:18	73,00
1396	24-06-2021 12:18	73,00
1397	24-06-2021 12:18	73,00
1398	24-06-2021 12:18	73,00
1399	24-06-2021 12:19	73,00
1400	24-06-2021 12:19	74,00
1401	24-06-2021 12:19	74,00
1402	24-06-2021 12:19	74,00
1403	24-06-2021 12:19	74,00
1404	24-06-2021 12:19	74,00
1405	24-06-2021 12:19	74,00
1406	24-06-2021 12:19	74,00
1407	24-06-2021 12:19	74,00
1408	24-06-2021 12:19	74,00
1409	24-06-2021 12:19	74,00
1410	24-06-2021 12:19	74,00
1411	24-06-2021 12:19	74,00
1412	24-06-2021 12:19	73,00
1413	24-06-2021 12:19	73,00
1414	24-06-2021 12:19	73,00
1415	24-06-2021 12:20	73,00
1416	24-06-2021 12:20	73,00
1417	24-06-2021 12:20	73,00
1418	24-06-2021 12:20	73,00
1419	24-06-2021 12:20	73,00
1420	24-06-2021 12:20	73,00
1421	24-06-2021 12:20	73,00
1422	24-06-2021 12:20	73,00
1423	24-06-2021 12:20	74,00



1424	24-06-2021 12:21	74,00
1425	24-06-2021 12:21	74,00
1426	24-06-2021 12:21	74,00
1427	24-06-2021 12:21	74,00
1428	24-06-2021 12:21	74,00
1429	24-06-2021 12:21	74,00
1430	24-06-2021 12:21	74,00
1431	24-06-2021 12:21	74,00
1432	24-06-2021 12:21	74,00
1433	24-06-2021 12:21	74,00
1434	24-06-2021 12:22	74,00
1435	24-06-2021 12:22	74,00
1436	24-06-2021 12:22	74,00
1437	24-06-2021 12:22	74,00
1438	24-06-2021 12:22	74,00
1439	24-06-2021 12:22	74,00
1440	24-06-2021 12:22	73,00
1441	24-06-2021 12:22	73,00
1442	24-06-2021 12:22	73,00
1443	24-06-2021 12:22	73,00
1444	24-06-2021 12:22	73,00
1445	24-06-2021 12:23	73,00
1446	24-06-2021 12:23	73,00
1447	24-06-2021 12:23	73,00
1448	24-06-2021 12:23	73,00
1449	24-06-2021 12:23	73,00
1450	24-06-2021 12:23	73,00
1451	24-06-2021 12:23	73,00
1452	24-06-2021 12:23	73,00
1453	24-06-2021 12:23	73,00
1454	24-06-2021 12:23	73,00
1455	24-06-2021 12:24	72,00
1456	24-06-2021 12:24	72,00
1457	24-06-2021 12:24	72,00
1458	24-06-2021 12:24	72,00
1459	24-06-2021 12:24	72,00
1460	24-06-2021 12:24	72,00
1461	24-06-2021 12:24	72,00
1462	24-06-2021 12:24	72,00
1463	24-06-2021 12:24	72,00
1464	24-06-2021 12:24	72,00
1465	24-06-2021 12:24	72,00

1466	24-06-2021 12:25	74,00
1467	24-06-2021 12:25	74,00
1468	24-06-2021 12:25	74,00
1469	24-06-2021 12:25	74,00
1470	24-06-2021 12:25	74,00
1471	24-06-2021 12:25	74,00
1472	24-06-2021 12:25	74,00
1473	24-06-2021 12:25	74,00
1474	24-06-2021 12:25	74,00
1475	24-06-2021 12:25	74,00
1476	24-06-2021 12:25	74,00
1477	24-06-2021 12:25	74,00
1478	24-06-2021 12:25	74,00
1479	24-06-2021 12:25	74,00
1480	24-06-2021 12:25	74,00
1481	24-06-2021 12:25	74,00
1482	24-06-2021 12:25	74,00
1483	24-06-2021 12:25	74,00
1484	24-06-2021 12:25	74,00
1485	24-06-2021 12:25	74,00
1486	24-06-2021 12:25	74,00
1487	24-06-2021 12:25	74,00
1488	24-06-2021 12:26	74,00
1489	24-06-2021 12:26	74,00
1490	24-06-2021 12:26	74,00
1491	24-06-2021 12:26	74,00
1492	24-06-2021 12:26	74,00
1493	24-06-2021 12:26	74,00
1494	24-06-2021 12:26	74,00
1495	24-06-2021 12:26	74,00
1496	24-06-2021 12:26	74,00
1497	24-06-2021 12:26	74,00
1498	24-06-2021 12:26	74,00
1499	24-06-2021 12:26	74,00
1500	24-06-2021 12:26	74,00
1501	24-06-2021 12:26	74,00
1502	24-06-2021 12:26	74,00
1503	24-06-2021 12:26	72,00
1504	24-06-2021 12:26	72,00
1505	24-06-2021 12:26	72,00
1506	24-06-2021 12:27	72,00
1507	24-06-2021 12:27	72,00

1508	24-06-2021 12:27	72,00
1509	24-06-2021 12:27	72,00
1510	24-06-2021 12:27	72,00
1511	24-06-2021 12:27	72,00
1512	24-06-2021 12:27	72,00
1513	24-06-2021 12:27	72,00
1514	24-06-2021 12:27	72,00
1515	24-06-2021 12:28	72,00
1516	24-06-2021 12:28	72,00
1517	24-06-2021 12:28	72,00
1518	24-06-2021 12:28	72,00
1519	24-06-2021 12:28	72,00
1520	24-06-2021 12:28	72,00
1521	24-06-2021 12:28	72,00
1522	24-06-2021 12:28	72,00
1523	24-06-2021 12:28	72,00
1524	24-06-2021 12:28	72,00
1525	24-06-2021 12:28	72,00
1526	24-06-2021 12:28	72,00
1527	24-06-2021 12:28	72,00
1528	24-06-2021 12:29	72,00
1529	24-06-2021 12:29	72,00
1530	24-06-2021 12:29	72,00
1531	24-06-2021 12:29	72,00
1532	24-06-2021 12:29	72,00
1533	24-06-2021 12:29	72,00
1534	24-06-2021 12:29	72,00
1535	24-06-2021 12:29	73,00
1536	24-06-2021 12:29	73,00
1537	24-06-2021 12:29	73,00
1538	24-06-2021 12:29	73,00
1539	24-06-2021 12:29	73,00
1540	24-06-2021 12:29	73,00
1541	24-06-2021 12:29	73,00
1542	24-06-2021 12:29	73,00
1543	24-06-2021 12:29	73,00
1544	24-06-2021 12:29	73,00
1545	24-06-2021 12:29	73,00
1546	24-06-2021 12:29	73,00
1547	24-06-2021 12:29	73,00
1548	24-06-2021 12:29	73,00
1549	24-06-2021 12:30	73,00

1550	24-06-2021 12:30	73,00
1551	24-06-2021 12:30	73,00
1552	24-06-2021 12:30	73,00
1553	24-06-2021 12:30	73,00
1554	24-06-2021 12:30	73,00
1555	24-06-2021 12:30	73,00
1556	24-06-2021 12:30	73,00
1557	24-06-2021 12:30	73,00
1558	24-06-2021 12:30	73,00
1559	24-06-2021 12:30	73,00
1560	24-06-2021 12:30	73,00
1561	24-06-2021 12:30	73,00
1562	24-06-2021 12:31	72,00
1563	24-06-2021 12:31	72,00
1564	24-06-2021 12:31	72,00
1565	24-06-2021 12:31	72,00
1566	24-06-2021 12:31	72,00
1567	24-06-2021 12:31	72,00
1568	24-06-2021 12:31	72,00
1569	24-06-2021 12:31	72,00
1570	24-06-2021 12:31	72,00
1571	24-06-2021 12:31	72,00
1572	24-06-2021 12:31	72,00
1573	24-06-2021 12:31	72,00
1574	24-06-2021 12:31	72,00
1575	24-06-2021 12:31	72,00
1576	24-06-2021 12:31	72,00
1577	24-06-2021 12:31	72,00
1578	24-06-2021 12:31	72,00
1579	24-06-2021 12:32	72,00
1580	24-06-2021 12:32	72,00
1581	24-06-2021 12:32	72,00
1582	24-06-2021 12:32	72,00
1583	24-06-2021 12:32	72,00
1584	24-06-2021 12:32	72,00
1585	24-06-2021 12:33	72,00
1586	24-06-2021 12:33	72,00
1587	24-06-2021 12:33	72,00
1588	24-06-2021 12:33	72,00
1589	24-06-2021 12:33	71,00
1590	24-06-2021 12:33	71,00
1591	24-06-2021 12:33	71,00

1592	24-06-2021 12:33	71,00
1593	24-06-2021 12:33	71,00
1594	24-06-2021 12:34	71,00
1595	24-06-2021 12:34	71,00
1596	24-06-2021 12:34	71,00
1597	24-06-2021 12:34	71,00
1598	24-06-2021 12:34	71,00
1599	24-06-2021 12:34	71,00
1600	24-06-2021 12:34	71,00
1601	24-06-2021 12:34	71,00
1602	24-06-2021 12:34	71,00
1603	24-06-2021 12:34	71,00
1604	24-06-2021 12:34	71,00
1605	24-06-2021 12:34	71,00
1606	24-06-2021 12:34	71,00
1607	24-06-2021 12:34	71,00
1608	24-06-2021 12:34	71,00
1609	24-06-2021 12:34	71,00
1610	24-06-2021 12:35	71,00
1611	24-06-2021 12:35	71,00
1612	24-06-2021 12:35	72,00
1613	24-06-2021 12:35	72,00
1614	24-06-2021 12:35	72,00
1615	24-06-2021 12:35	72,00
1616	24-06-2021 12:35	72,00
1617	24-06-2021 12:35	72,00
1618	24-06-2021 12:35	72,00
1619	24-06-2021 12:36	72,00
1620	24-06-2021 12:36	72,00
1621	24-06-2021 12:36	72,00
1622	24-06-2021 12:36	72,00
1623	24-06-2021 12:36	72,00
1624	24-06-2021 12:36	72,00
1625	24-06-2021 12:36	72,00
1626	24-06-2021 12:36	72,00
1627	24-06-2021 12:36	72,00
1628	24-06-2021 12:36	72,00
1629	24-06-2021 12:36	72,00
1630	24-06-2021 12:37	72,00
1631	24-06-2021 12:37	72,00
1632	24-06-2021 12:37	72,00
1633	24-06-2021 12:37	72,00

1634	24-06-2021 12:37	72,00
1635	24-06-2021 12:37	72,00
1636	24-06-2021 12:37	72,00
1637	24-06-2021 12:37	72,00
1638	24-06-2021 12:37	72,00
1639	24-06-2021 12:37	72,00
1640	24-06-2021 12:37	72,00
1641	24-06-2021 12:37	72,00
1642	24-06-2021 12:37	72,00
1643	24-06-2021 12:37	72,00
1644	24-06-2021 12:37	72,00
1645	24-06-2021 12:38	72,00
1646	24-06-2021 12:38	72,00
1647	24-06-2021 12:38	72,00
1648	24-06-2021 12:38	72,00
1649	24-06-2021 12:38	72,00
1650	24-06-2021 12:38	72,00
1651	24-06-2021 12:38	72,00
1652	24-06-2021 12:38	72,00
1653	24-06-2021 12:38	72,00
1654	24-06-2021 12:38	72,00
1655	24-06-2021 12:38	71,00
1656	24-06-2021 12:38	71,00
1657	24-06-2021 12:38	71,00
1658	24-06-2021 12:38	71,00
1659	24-06-2021 12:38	71,00
1660	24-06-2021 12:38	71,00
1661	24-06-2021 12:38	71,00
1662	24-06-2021 12:39	71,00
1663	24-06-2021 12:39	71,00
1664	24-06-2021 12:39	71,00
1665	24-06-2021 12:39	71,00
1666	24-06-2021 12:39	71,00
1667	24-06-2021 12:39	71,00
1668	24-06-2021 12:39	71,00
1669	24-06-2021 12:39	71,00
1670	24-06-2021 12:39	69,00
1671	24-06-2021 12:39	69,00
1672	24-06-2021 12:39	69,00
1673	24-06-2021 12:39	69,00
1674	24-06-2021 12:39	69,00
1675	24-06-2021 12:39	69,00

1676	24-06-2021 12:39	69,00
1677	24-06-2021 12:39	69,00
1678	24-06-2021 12:39	69,00
1679	24-06-2021 12:39	69,00
1680	24-06-2021 12:39	69,00
1681	24-06-2021 12:40	69,00
1682	24-06-2021 12:40	69,00
1683	24-06-2021 12:40	69,00
1684	24-06-2021 12:40	69,00
1685	24-06-2021 12:40	68,00
1686	24-06-2021 12:40	68,00
1687	24-06-2021 12:40	68,00
1688	24-06-2021 12:40	68,00
1689	24-06-2021 12:40	68,00
1690	24-06-2021 12:40	68,00
1691	24-06-2021 12:40	68,00
1692	24-06-2021 12:40	68,00
1693	24-06-2021 12:40	68,00
1694	24-06-2021 12:40	68,00
1695	24-06-2021 12:40	68,00
1696	24-06-2021 12:40	68,00
1697	24-06-2021 12:41	68,00
1698	24-06-2021 12:41	68,00
1699	24-06-2021 12:41	68,00
1700	24-06-2021 12:41	68,00
1701	24-06-2021 12:41	68,00
1702	24-06-2021 12:41	68,00
1703	24-06-2021 12:41	68,00
1704	24-06-2021 12:41	68,00
1705	24-06-2021 12:41	68,00
1706	24-06-2021 12:41	68,00
1707	24-06-2021 12:41	68,00
1708	24-06-2021 12:41	68,00
1709	24-06-2021 12:41	68,00
1710	24-06-2021 12:41	68,00
1711	24-06-2021 12:42	68,00
1712	24-06-2021 12:42	68,00
1713	24-06-2021 12:42	68,00
1714	24-06-2021 12:42	68,00
1715	24-06-2021 12:43	68,00
1716	24-06-2021 12:43	68,00
1717	24-06-2021 12:43	68,00

1718	24-06-2021 12:43	68,00
1719	24-06-2021 12:43	68,00
1720	24-06-2021 12:43	68,00
1721	24-06-2021 12:43	68,00
1722	24-06-2021 12:43	68,00
1723	24-06-2021 12:43	68,00
1724	24-06-2021 12:43	68,00
1725	24-06-2021 12:43	68,00
1726	24-06-2021 12:43	68,00
1727	24-06-2021 12:43	68,00
1728	24-06-2021 12:44	68,00
1729	24-06-2021 12:44	68,00
1730	24-06-2021 12:44	68,00
1731	24-06-2021 12:44	68,00
1732	24-06-2021 12:44	68,00
1733	24-06-2021 12:44	68,00
1734	24-06-2021 12:44	68,00
1735	24-06-2021 12:44	67,00
1736	24-06-2021 12:44	67,00
1737	24-06-2021 12:44	67,00
1738	24-06-2021 12:44	67,00
1739	24-06-2021 12:45	67,00
1740	24-06-2021 12:45	67,00
1741	24-06-2021 12:45	67,00
1742	24-06-2021 12:45	67,00
1743	24-06-2021 12:45	67,00
1744	24-06-2021 12:45	67,00
1745	24-06-2021 12:45	67,00
1746	24-06-2021 12:45	67,00
1747	24-06-2021 12:45	67,00
1748	24-06-2021 12:45	67,00
1749	24-06-2021 12:45	67,00
1750	24-06-2021 12:46	66,00
1751	24-06-2021 12:46	66,00
1752	24-06-2021 12:46	66,00
1753	24-06-2021 12:46	66,00
1754	24-06-2021 12:47	67,00
1755	24-06-2021 12:47	67,00
1756	24-06-2021 12:47	67,00
1757	24-06-2021 12:47	67,00
1758	24-06-2021 12:47	67,00
1759	24-06-2021 12:47	67,00

1760	24-06-2021 12:47	67,00
1761	24-06-2021 12:48	67,00
1762	24-06-2021 12:48	67,00
1763	24-06-2021 12:48	67,00
1764	24-06-2021 12:48	67,00
1765	24-06-2021 12:48	67,00
1766	24-06-2021 12:48	67,00
1767	24-06-2021 12:48	67,00
1768	24-06-2021 12:48	67,00
1769	24-06-2021 12:48	67,00
1770	24-06-2021 12:48	67,00
1771	24-06-2021 12:48	67,00
1772	24-06-2021 12:48	67,00
1773	24-06-2021 12:48	67,00
1774	24-06-2021 12:48	67,00
1775	24-06-2021 12:48	67,00
1776	24-06-2021 12:48	67,00
1777	24-06-2021 12:48	67,00
1778	24-06-2021 12:49	66,00
1779	24-06-2021 12:49	66,00
1780	24-06-2021 12:49	66,00
1781	24-06-2021 12:49	66,00
1782	24-06-2021 12:49	66,00
1783	24-06-2021 12:49	66,00
1784	24-06-2021 12:49	66,00
1785	24-06-2021 12:49	66,00
1786	24-06-2021 12:49	66,00
1787	24-06-2021 12:49	66,00
1788	24-06-2021 12:49	66,00
1789	24-06-2021 12:49	66,00
1790	24-06-2021 12:49	66,00
1791	24-06-2021 12:49	66,00
1792	24-06-2021 12:49	66,00
1793	24-06-2021 12:49	66,00
1794	24-06-2021 12:49	66,00
1795	24-06-2021 12:49	65,00
1796	24-06-2021 12:50	65,00
1797	24-06-2021 12:50	65,00
1798	24-06-2021 12:50	65,00
1799	24-06-2021 12:50	65,00
1800	24-06-2021 12:50	65,00
1801	24-06-2021 12:50	66,00

1802	24-06-2021 12:50	66,00
1803	24-06-2021 12:50	66,00
1804	24-06-2021 12:50	66,00
1805	24-06-2021 12:50	66,00
1806	24-06-2021 12:50	66,00
1807	24-06-2021 12:51	66,00
1808	24-06-2021 12:51	66,00
1809	24-06-2021 12:51	66,00
1810	24-06-2021 12:51	66,00
1811	24-06-2021 12:51	66,00
1812	24-06-2021 12:51	66,00
1813	24-06-2021 12:51	66,00
1814	24-06-2021 12:51	66,00
1815	24-06-2021 12:51	66,00
1816	24-06-2021 12:51	66,00
1817	24-06-2021 12:51	66,00
1818	24-06-2021 12:51	66,00
1819	24-06-2021 12:51	66,00
1820	24-06-2021 12:51	66,00
1821	24-06-2021 12:51	66,00
1822	24-06-2021 12:51	66,00
1823	24-06-2021 12:51	66,00
1824	24-06-2021 12:51	66,00
1825	24-06-2021 12:51	66,00
1826	24-06-2021 12:51	66,00
1827	24-06-2021 12:51	66,00
1828	24-06-2021 12:51	66,00
1829	24-06-2021 12:51	66,00
1830	24-06-2021 12:51	66,00
1831	24-06-2021 12:51	66,00
1832	24-06-2021 12:51	66,00
1833	24-06-2021 12:51	66,00
1834	24-06-2021 12:52	66,00
1835	24-06-2021 12:52	66,00
1836	24-06-2021 12:52	66,00
1837	24-06-2021 12:52	66,00
1838	24-06-2021 12:52	66,00
1839	24-06-2021 12:52	66,00
1840	24-06-2021 12:52	66,00
1841	24-06-2021 12:52	66,00
1842	24-06-2021 12:52	66,00
1843	24-06-2021 12:52	66,00

1844	24-06-2021 12:52	67,00
1845	24-06-2021 12:53	66,00
1846	24-06-2021 12:53	66,00
1847	24-06-2021 12:53	66,00
1848	24-06-2021 12:53	66,00
1849	24-06-2021 12:53	66,00
1850	24-06-2021 12:53	66,00
1851	24-06-2021 12:53	66,00
1852	24-06-2021 12:53	66,00
1853	24-06-2021 12:53	66,00
1854	24-06-2021 12:53	66,00
1855	24-06-2021 12:53	66,00
1856	24-06-2021 12:54	65,00
1857	24-06-2021 12:54	65,00
1858	24-06-2021 12:54	65,00
1859	24-06-2021 12:54	65,00
1860	24-06-2021 12:54	65,00
1861	24-06-2021 12:54	65,00
1862	24-06-2021 12:54	65,00
1863	24-06-2021 12:54	65,00
1864	24-06-2021 12:54	65,00
1865	24-06-2021 12:54	65,00
1866	24-06-2021 12:54	65,00
1867	24-06-2021 12:55	64,00
1868	24-06-2021 12:55	64,00
1869	24-06-2021 12:55	64,00
1870	24-06-2021 12:55	65,00
1871	24-06-2021 12:55	65,00
1872	24-06-2021 12:55	65,00
1873	24-06-2021 12:55	65,00
1874	24-06-2021 12:55	65,00
1875	24-06-2021 12:56	65,00
1876	24-06-2021 12:56	65,00
1877	24-06-2021 12:56	65,00
1878	24-06-2021 12:56	65,00
1879	24-06-2021 12:56	65,00
1880	24-06-2021 12:56	65,00
1881	24-06-2021 12:56	65,00
1882	24-06-2021 12:56	65,00
1883	24-06-2021 12:56	64,00
1884	24-06-2021 12:56	64,00
1885	24-06-2021 12:56	64,00

1886	24-06-2021 12:56	64,00
1887	24-06-2021 12:56	64,00
1888	24-06-2021 12:56	64,00
1889	24-06-2021 12:56	64,00
1890	24-06-2021 12:57	64,00
1891	24-06-2021 12:57	64,00
1892	24-06-2021 12:57	64,00
1893	24-06-2021 12:57	64,00
1894	24-06-2021 12:57	64,00
1895	24-06-2021 12:57	64,00
1896	24-06-2021 12:57	64,00
1897	24-06-2021 12:57	64,00
1898	24-06-2021 12:57	64,00
1899	24-06-2021 12:57	64,00
1900	24-06-2021 12:57	64,00
1901	24-06-2021 12:57	64,00
1902	24-06-2021 12:58	64,00
1903	24-06-2021 12:58	64,00
1904	24-06-2021 12:58	64,00
1905	24-06-2021 12:58	64,00
1906	24-06-2021 12:58	64,00
1907	24-06-2021 12:58	64,00
1908	24-06-2021 12:58	64,00
1909	24-06-2021 12:58	64,00
1910	24-06-2021 12:58	64,00
1911	24-06-2021 12:58	64,00
1912	24-06-2021 12:58	64,00
1913	24-06-2021 12:59	64,00
1914	24-06-2021 13:00	65,00
1915	24-06-2021 13:00	65,00
1916	24-06-2021 13:00	65,00
1917	24-06-2021 13:00	65,00
1918	24-06-2021 13:00	65,00
1919	24-06-2021 13:00	65,00
1920	24-06-2021 13:00	65,00
1921	24-06-2021 13:00	65,00
1922	24-06-2021 13:00	65,00
1923	24-06-2021 13:00	65,00
1924	24-06-2021 13:00	65,00
1925	24-06-2021 13:00	65,00
1926	24-06-2021 13:00	65,00
1927	24-06-2021 13:00	65,00

1928	24-06-2021 13:00	65,00
1929	24-06-2021 13:00	65,00
1930	24-06-2021 13:00	65,00
1931	24-06-2021 13:00	65,00
1932	24-06-2021 13:01	65,00
1933	24-06-2021 13:01	65,00
1934	24-06-2021 13:01	65,00
1935	24-06-2021 13:01	65,00
1936	24-06-2021 13:01	65,00
1937	24-06-2021 13:01	65,00
1938	24-06-2021 13:01	65,00
1939	24-06-2021 13:01	66,00
1940	24-06-2021 13:02	66,00
1941	24-06-2021 13:03	66,00
1942	24-06-2021 13:03	66,00
1943	24-06-2021 13:03	66,00
1944	24-06-2021 13:03	65,00
1945	24-06-2021 13:03	65,00
1946	24-06-2021 13:03	65,00
1947	24-06-2021 13:03	65,00
1948	24-06-2021 13:03	65,00
1949	24-06-2021 13:04	65,00
1950	24-06-2021 13:04	65,00
1951	24-06-2021 13:05	66,00
1952	24-06-2021 13:06	66,00
1953	24-06-2021 13:06	66,00
1954	24-06-2021 13:06	66,00
1955	24-06-2021 13:06	66,00
1956	24-06-2021 13:06	66,00
1957	24-06-2021 13:06	66,00
1958	24-06-2021 13:06	66,00
1959	24-06-2021 13:06	66,00
1960	24-06-2021 13:06	66,00
1961	24-06-2021 13:06	66,00
1962	24-06-2021 13:06	66,00
1963	24-06-2021 13:06	66,00
1964	24-06-2021 13:06	66,00
1965	24-06-2021 13:06	66,00
1966	24-06-2021 13:06	66,00
1967	24-06-2021 13:07	66,00
1968	24-06-2021 13:07	66,00
1969	24-06-2021 13:07	66,00

1970	24-06-2021 13:07	66,00
1971	24-06-2021 13:07	66,00
1972	24-06-2021 13:07	66,00
1973	24-06-2021 13:07	68,00
1974	24-06-2021 13:07	68,00
1975	24-06-2021 13:07	68,00
1976	24-06-2021 13:07	68,00
1977	24-06-2021 13:08	68,00
1978	24-06-2021 13:08	68,00
1979	24-06-2021 13:08	68,00
1980	24-06-2021 13:08	68,00
1981	24-06-2021 13:08	68,00
1982	24-06-2021 13:08	68,00
1983	24-06-2021 13:08	68,00
1984	24-06-2021 13:08	68,00
1985	24-06-2021 13:08	68,00
1986	24-06-2021 13:08	67,00
1987	24-06-2021 13:08	67,00
1988	24-06-2021 13:08	67,00
1989	24-06-2021 13:09	67,00
1990	24-06-2021 13:09	67,00
1991	24-06-2021 13:09	67,00
1992	24-06-2021 13:09	67,00
1993	24-06-2021 13:09	67,00
1994	24-06-2021 13:09	67,00
1995	24-06-2021 13:09	67,00
1996	24-06-2021 13:09	67,00
1997	24-06-2021 13:09	67,00
1998	24-06-2021 13:09	67,00
1999	24-06-2021 13:09	67,00
2000	24-06-2021 13:09	67,00
2001	24-06-2021 13:09	67,00
2002	24-06-2021 13:09	67,00
2003	24-06-2021 13:09	67,00
2004	24-06-2021 13:09	67,00
2005	24-06-2021 13:09	67,00
2006	24-06-2021 13:09	67,00
2007	24-06-2021 13:09	67,00
2008	24-06-2021 13:10	67,00
2009	24-06-2021 13:10	67,00
2010	24-06-2021 13:10	67,00
2011	24-06-2021 13:10	67,00

2012	24-06-2021 13:10	66,00
2013	24-06-2021 13:10	66,00
2014	24-06-2021 13:10	66,00
2015	24-06-2021 13:10	66,00
2016	24-06-2021 13:10	66,00
2017	24-06-2021 13:10	66,00
2018	24-06-2021 13:10	66,00
2019	24-06-2021 13:10	66,00
2020	24-06-2021 13:10	66,00
2021	24-06-2021 13:10	66,00
2022	24-06-2021 13:10	66,00
2023	24-06-2021 13:10	66,00
2024	24-06-2021 13:10	66,00
2025	24-06-2021 13:12	67,00
2026	24-06-2021 13:12	67,00
2027	24-06-2021 13:12	67,00
2028	24-06-2021 13:12	67,00
2029	24-06-2021 13:12	67,00
2030	24-06-2021 13:12	67,00
2031	24-06-2021 13:12	67,00
2032	24-06-2021 13:12	67,00
2033	24-06-2021 13:12	67,00
2034	24-06-2021 13:12	67,00
2035	24-06-2021 13:12	67,00
2036	24-06-2021 13:12	67,00
2037	24-06-2021 13:12	67,00
2038	24-06-2021 13:12	67,00
2039	24-06-2021 13:13	67,00
2040	24-06-2021 13:13	67,00
2041	24-06-2021 13:13	67,00
2042	24-06-2021 13:13	67,00
2043	24-06-2021 13:13	67,00
2044	24-06-2021 13:13	67,00
2045	24-06-2021 13:13	67,00
2046	24-06-2021 13:13	67,00
2047	24-06-2021 13:13	67,00
2048	24-06-2021 13:13	67,00
2049	24-06-2021 13:13	67,00
2050	24-06-2021 13:13	65,00
2051	24-06-2021 13:13	65,00
2052	24-06-2021 13:13	65,00
2053	24-06-2021 13:13	65,00

2054	24-06-2021 13:13	65,00
2055	24-06-2021 13:13	65,00
2056	24-06-2021 13:14	65,00
2057	24-06-2021 13:14	65,00
2058	24-06-2021 13:14	65,00
2059	24-06-2021 13:14	65,00
2060	24-06-2021 13:14	65,00
2061	24-06-2021 13:14	65,00
2062	24-06-2021 13:14	65,00
2063	24-06-2021 13:14	65,00
2064	24-06-2021 13:14	65,00
2065	24-06-2021 13:14	65,00
2066	24-06-2021 13:14	64,00
2067	24-06-2021 13:14	64,00
2068	24-06-2021 13:14	64,00
2069	24-06-2021 13:14	64,00
2070	24-06-2021 13:14	64,00
2071	24-06-2021 13:14	64,00
2072	24-06-2021 13:14	64,00
2073	24-06-2021 13:15	64,00
2074	24-06-2021 13:15	64,00
2075	24-06-2021 13:15	64,00
2076	24-06-2021 13:15	64,00
2077	24-06-2021 13:15	64,00
2078	24-06-2021 13:15	64,00
2079	24-06-2021 13:15	64,00
2080	24-06-2021 13:15	64,00
2081	24-06-2021 13:16	67,00
2082	24-06-2021 13:16	67,00
2083	24-06-2021 13:16	67,00
2084	24-06-2021 13:16	64,00
2085	24-06-2021 13:16	64,00
2086	24-06-2021 13:16	64,00
2087	24-06-2021 13:16	64,00
2088	24-06-2021 13:16	64,00
2089	24-06-2021 13:16	64,00
2090	24-06-2021 13:16	64,00
2091	24-06-2021 13:16	64,00
2092	24-06-2021 13:16	64,00
2093	24-06-2021 13:16	64,00
2094	24-06-2021 13:16	64,00
2095	24-06-2021 13:16	64,00



2096	24-06-2021 13:16	64,00
2097	24-06-2021 13:16	64,00
2098	24-06-2021 13:16	64,00
2099	24-06-2021 13:16	64,00
2100	24-06-2021 13:17	64,00
2101	24-06-2021 13:17	64,00
2102	24-06-2021 13:17	64,00
2103	24-06-2021 13:17	63,00
2104	24-06-2021 13:17	63,00
2105	24-06-2021 13:17	63,00
2106	24-06-2021 13:17	63,00
2107	24-06-2021 13:17	63,00
2108	24-06-2021 13:17	63,00
2109	24-06-2021 13:17	63,00
2110	24-06-2021 13:17	63,00
2111	24-06-2021 13:17	63,00
2112	24-06-2021 13:17	63,00
2113	24-06-2021 13:17	64,00
2114	24-06-2021 13:18	64,00
2115	24-06-2021 13:18	64,00
2116	24-06-2021 13:18	64,00
2117	24-06-2021 13:18	64,00
2118	24-06-2021 13:18	64,00
2119	24-06-2021 13:18	64,00
2120	24-06-2021 13:18	64,00
2121	24-06-2021 13:18	64,00
2122	24-06-2021 13:18	64,00
2123	24-06-2021 13:18	64,00
2124	24-06-2021 13:18	64,00
2125	24-06-2021 13:18	64,00
2126	24-06-2021 13:18	64,00
2127	24-06-2021 13:18	64,00
2128	24-06-2021 13:18	64,00
2129	24-06-2021 13:18	64,00
2130	24-06-2021 13:18	64,00
2131	24-06-2021 13:18	64,00
2132	24-06-2021 13:18	64,00
2133	24-06-2021 13:18	64,00
2134	24-06-2021 13:18	63,00
2135	24-06-2021 13:18	63,00
2136	24-06-2021 13:18	63,00
2137	24-06-2021 13:18	63,00

2138	24-06-2021 13:18	63,00
2139	24-06-2021 13:19	63,00
2140	24-06-2021 13:19	63,00
2141	24-06-2021 13:19	63,00
2142	24-06-2021 13:19	63,00
2143	24-06-2021 13:19	63,00
2144	24-06-2021 13:19	63,00
2145	24-06-2021 13:19	63,00
2146	24-06-2021 13:19	63,00
2147	24-06-2021 13:19	63,00
2148	24-06-2021 13:19	63,00
2149	24-06-2021 13:19	63,00
2150	24-06-2021 13:19	63,00
2151	24-06-2021 13:19	63,00
2152	24-06-2021 13:19	63,00
2153	24-06-2021 13:19	64,00
2154	24-06-2021 13:19	64,00
2155	24-06-2021 13:19	64,00
2156	24-06-2021 13:19	64,00
2157	24-06-2021 13:19	64,00
2158	24-06-2021 13:19	64,00
2159	24-06-2021 13:20	64,00
2160	24-06-2021 13:20	64,00
2161	24-06-2021 13:20	64,00
2162	24-06-2021 13:20	64,00
2163	24-06-2021 13:20	64,00
2164	24-06-2021 13:20	64,00
2165	24-06-2021 13:20	64,00
2166	24-06-2021 13:20	64,00
2167	24-06-2021 13:20	64,00
2168	24-06-2021 13:20	64,00
2169	24-06-2021 13:20	64,00
2170	24-06-2021 13:20	64,00
2171	24-06-2021 13:20	64,00
2172	24-06-2021 13:20	64,00
2173	24-06-2021 13:20	64,00
2174	24-06-2021 13:20	64,00
2175	24-06-2021 13:20	64,00
2176	24-06-2021 13:20	64,00
2177	24-06-2021 13:20	64,00
2178	24-06-2021 13:20	64,00
2179	24-06-2021 13:21	64,00

2180	24-06-2021 13:21	64,00
2181	24-06-2021 13:21	64,00
2182	24-06-2021 13:21	64,00
2183	24-06-2021 13:21	64,00
2184	24-06-2021 13:21	64,00
2185	24-06-2021 13:21	64,00
2186	24-06-2021 13:21	64,00
2187	24-06-2021 13:21	64,00
2188	24-06-2021 13:21	64,00
2189	24-06-2021 13:22	65,00
2190	24-06-2021 13:22	65,00
2191	24-06-2021 13:22	65,00
2192	24-06-2021 13:22	65,00
2193	24-06-2021 13:22	65,00
2194	24-06-2021 13:22	65,00
2195	24-06-2021 13:22	65,00
2196	24-06-2021 13:23	65,00
2197	24-06-2021 13:23	65,00
2198	24-06-2021 13:23	65,00
2199	24-06-2021 13:23	65,00
2200	24-06-2021 13:23	65,00
2201	24-06-2021 13:23	65,00
2202	24-06-2021 13:23	65,00
2203	24-06-2021 13:23	65,00
2204	24-06-2021 13:23	65,00
2205	24-06-2021 13:24	65,00
2206	24-06-2021 13:24	65,00
2207	24-06-2021 13:24	65,00
2208	24-06-2021 13:24	65,00
2209	24-06-2021 13:24	65,00
2210	24-06-2021 13:25	66,00
2211	24-06-2021 13:25	66,00
2212	24-06-2021 13:25	66,00
2213	24-06-2021 13:25	66,00
2214	24-06-2021 13:25	66,00
2215	24-06-2021 13:26	65,00
2216	24-06-2021 13:26	65,00
2217	24-06-2021 13:26	65,00
2218	24-06-2021 13:26	65,00
2219	24-06-2021 13:26	65,00
2220	24-06-2021 13:26	65,00
2221	24-06-2021 13:27	66,00

2222	24-06-2021 13:27	66,00
2223	24-06-2021 13:27	66,00
2224	24-06-2021 13:27	66,00
2225	24-06-2021 13:27	66,00
2226	24-06-2021 13:27	65,00
2227	24-06-2021 13:27	65,00
2228	24-06-2021 13:27	65,00
2229	24-06-2021 13:27	65,00
2230	24-06-2021 13:27	65,00
2231	24-06-2021 13:27	65,00
2232	24-06-2021 13:27	65,00
2233	24-06-2021 13:27	65,00
2234	24-06-2021 13:27	65,00
2235	24-06-2021 13:28	65,00
2236	24-06-2021 13:28	65,00
2237	24-06-2021 13:28	65,00
2238	24-06-2021 13:28	65,00
2239	24-06-2021 13:28	65,00
2240	24-06-2021 13:28	65,00
2241	24-06-2021 13:28	65,00
2242	24-06-2021 13:28	65,00
2243	24-06-2021 13:28	65,00
2244	24-06-2021 13:28	65,00
2245	24-06-2021 13:28	65,00
2246	24-06-2021 13:28	65,00
2247	24-06-2021 13:28	65,00
2248	24-06-2021 13:28	65,00
2249	24-06-2021 13:28	65,00
2250	24-06-2021 13:28	65,00
2251	24-06-2021 13:28	65,00
2252	24-06-2021 13:28	65,00
2253	24-06-2021 13:28	65,00
2254	24-06-2021 13:28	65,00
2255	24-06-2021 13:28	65,00
2256	24-06-2021 13:29	65,00
2257	24-06-2021 13:29	66,00
2258	24-06-2021 13:29	66,00
2259	24-06-2021 13:29	66,00
2260	24-06-2021 13:29	66,00
2261	24-06-2021 13:29	66,00
2262	24-06-2021 13:29	66,00
2263	24-06-2021 13:29	66,00

2264	24-06-2021 13:29	66,00
2265	24-06-2021 13:29	66,00
2266	24-06-2021 13:29	66,00
2267	24-06-2021 13:29	66,00
2268	24-06-2021 13:29	66,00
2269	24-06-2021 13:29	66,00
2270	24-06-2021 13:29	66,00
2271	24-06-2021 13:30	66,00
2272	24-06-2021 13:30	66,00
2273	24-06-2021 13:30	66,00
2274	24-06-2021 13:30	66,00
2275	24-06-2021 13:30	66,00
2276	24-06-2021 13:30	66,00
2277	24-06-2021 13:30	66,00
2278	24-06-2021 13:30	66,00
2279	24-06-2021 13:30	66,00
2280	24-06-2021 13:30	66,00
2281	24-06-2021 13:30	66,00
2282	24-06-2021 13:30	66,00
2283	24-06-2021 13:30	66,00
2284	24-06-2021 13:30	66,00
2285	24-06-2021 13:30	66,00
2286	24-06-2021 13:30	66,00
2287	24-06-2021 13:30	66,00
2288	24-06-2021 13:30	66,00
2289	24-06-2021 13:30	66,00
2290	24-06-2021 13:30	66,00
2291	24-06-2021 13:30	66,00
2292	24-06-2021 13:31	66,00
2293	24-06-2021 13:31	66,00
2294	24-06-2021 13:31	66,00
2295	24-06-2021 13:31	66,00
2296	24-06-2021 13:31	66,00
2297	24-06-2021 13:31	66,00
2298	24-06-2021 13:31	66,00
2299	24-06-2021 13:31	66,00
2300	24-06-2021 13:31	66,00
2301	24-06-2021 13:31	66,00
2302	24-06-2021 13:31	66,00
2303	24-06-2021 13:31	66,00
2304	24-06-2021 13:31	66,00
2305	24-06-2021 13:31	64,00

2306	24-06-2021 13:32	64,00
2307	24-06-2021 13:32	64,00
2308	24-06-2021 13:32	64,00
2309	24-06-2021 13:32	64,00
2310	24-06-2021 13:32	64,00
2311	24-06-2021 13:32	64,00
2312	24-06-2021 13:32	63,00
2313	24-06-2021 13:32	63,00
2314	24-06-2021 13:32	63,00
2315	24-06-2021 13:32	63,00
2316	24-06-2021 13:33	63,00
2317	24-06-2021 13:33	63,00
2318	24-06-2021 13:33	63,00
2319	24-06-2021 13:33	64,00
2320	24-06-2021 13:33	64,00
2321	24-06-2021 13:33	64,00
2322	24-06-2021 13:33	64,00
2323	24-06-2021 13:33	64,00
2324	24-06-2021 13:33	64,00
2325	24-06-2021 13:33	64,00
2326	24-06-2021 13:33	64,00
2327	24-06-2021 13:33	64,00
2328	24-06-2021 13:33	64,00
2329	24-06-2021 13:34	64,00
2330	24-06-2021 13:34	64,00
2331	24-06-2021 13:34	64,00
2332	24-06-2021 13:34	65,00
2333	24-06-2021 13:34	65,00
2334	24-06-2021 13:34	65,00
2335	24-06-2021 13:34	65,00
2336	24-06-2021 13:34	65,00
2337	24-06-2021 13:34	65,00
2338	24-06-2021 13:34	65,00
2339	24-06-2021 13:34	65,00
2340	24-06-2021 13:34	65,00
2341	24-06-2021 13:35	65,00
2342	24-06-2021 13:35	66,00
2343	24-06-2021 13:35	66,00
2344	24-06-2021 13:35	66,00
2345	24-06-2021 13:35	66,00
2346	24-06-2021 13:35	66,00
2347	24-06-2021 13:35	66,00

2348	24-06-2021 13:35	66,00
2349	24-06-2021 13:35	66,00
2350	24-06-2021 13:36	67,00
2351	24-06-2021 13:36	67,00
2352	24-06-2021 13:36	67,00
2353	24-06-2021 13:36	67,00
2354	24-06-2021 13:36	67,00
2355	24-06-2021 13:36	67,00
2356	24-06-2021 13:36	67,00
2357	24-06-2021 13:36	67,00
2358	24-06-2021 13:36	67,00
2359	24-06-2021 13:36	67,00
2360	24-06-2021 13:36	67,00
2361	24-06-2021 13:37	67,00
2362	24-06-2021 13:37	67,00
2363	24-06-2021 13:37	67,00
2364	24-06-2021 13:37	67,00
2365	24-06-2021 13:37	67,00
2366	24-06-2021 13:37	67,00
2367	24-06-2021 13:37	67,00
2368	24-06-2021 13:37	67,00
2369	24-06-2021 13:37	67,00
2370	24-06-2021 13:37	68,00
2371	24-06-2021 13:37	68,00
2372	24-06-2021 13:37	68,00
2373	24-06-2021 13:37	68,00
2374	24-06-2021 13:37	68,00
2375	24-06-2021 13:37	68,00
2376	24-06-2021 13:38	68,00
2377	24-06-2021 13:38	68,00
2378	24-06-2021 13:38	68,00
2379	24-06-2021 13:38	68,00
2380	24-06-2021 13:38	68,00
2381	24-06-2021 13:38	68,00
2382	24-06-2021 13:38	68,00
2383	24-06-2021 13:38	68,00
2384	24-06-2021 13:38	68,00
2385	24-06-2021 13:38	69,00
2386	24-06-2021 13:38	69,00
2387	24-06-2021 13:38	69,00
2388	24-06-2021 13:38	69,00
2389	24-06-2021 13:39	69,00

2390	24-06-2021 13:39	69,00
2391	24-06-2021 13:39	69,00
2392	24-06-2021 13:39	69,00
2393	24-06-2021 13:39	69,00
2394	24-06-2021 13:39	69,00
2395	24-06-2021 13:39	69,00
2396	24-06-2021 13:39	69,00
2397	24-06-2021 13:39	69,00
2398	24-06-2021 13:39	69,00
2399	24-06-2021 13:39	69,00
2400	24-06-2021 13:39	69,00
2401	24-06-2021 13:39	69,00
2402	24-06-2021 13:39	69,00
2403	24-06-2021 13:39	69,00
2404	24-06-2021 13:40	69,00
2405	24-06-2021 13:40	69,00
2406	24-06-2021 13:40	69,00
2407	24-06-2021 13:40	69,00
2408	24-06-2021 13:40	69,00
2409	24-06-2021 13:40	70,00
2410	24-06-2021 13:40	70,00
2411	24-06-2021 13:40	70,00
2412	24-06-2021 13:40	70,00
2413	24-06-2021 13:40	70,00
2414	24-06-2021 13:40	70,00
2415	24-06-2021 13:40	70,00
2416	24-06-2021 13:40	70,00
2417	24-06-2021 13:40	70,00
2418	24-06-2021 13:40	70,00
2419	24-06-2021 13:40	70,00
2420	24-06-2021 13:41	70,00
2421	24-06-2021 13:41	71,00
2422	24-06-2021 13:41	71,00
2423	24-06-2021 13:41	71,00
2424	24-06-2021 13:41	71,00
2425	24-06-2021 13:41	71,00
2426	24-06-2021 13:41	71,00
2427	24-06-2021 13:41	71,00
2428	24-06-2021 13:41	71,00
2429	24-06-2021 13:41	71,00
2430	24-06-2021 13:41	71,00
2431	24-06-2021 13:41	71,00

2432	24-06-2021 13:41	71,00
2433	24-06-2021 13:41	72,00
2434	24-06-2021 13:41	72,00
2435	24-06-2021 13:42	72,00
2436	24-06-2021 13:42	72,00
2437	24-06-2021 13:42	72,00
2438	24-06-2021 13:42	72,00
2439	24-06-2021 13:42	72,00
2440	24-06-2021 13:42	72,00
2441	24-06-2021 13:42	72,00
2442	24-06-2021 13:42	72,00
2443	24-06-2021 13:42	72,00
2444	24-06-2021 13:42	72,00
2445	24-06-2021 13:42	72,00
2446	24-06-2021 13:42	72,00
2447	24-06-2021 13:42	72,00
2448	24-06-2021 13:42	72,00
2449	24-06-2021 13:42	72,00
2450	24-06-2021 13:42	72,00
2451	24-06-2021 13:42	72,00
2452	24-06-2021 13:42	72,00
2453	24-06-2021 13:42	72,00
2454	24-06-2021 13:43	72,00
2455	24-06-2021 13:43	72,00
2456	24-06-2021 13:43	72,00
2457	24-06-2021 13:43	72,00
2458	24-06-2021 13:43	72,00
2459	24-06-2021 13:43	72,00
2460	24-06-2021 13:43	72,00
2461	24-06-2021 13:43	72,00
2462	24-06-2021 13:43	72,00
2463	24-06-2021 13:43	72,00
2464	24-06-2021 13:43	72,00
2465	24-06-2021 13:43	72,00
2466	24-06-2021 13:43	72,00
2467	24-06-2021 13:43	72,00
2468	24-06-2021 13:43	72,00
2469	24-06-2021 13:44	72,00
2470	24-06-2021 13:44	72,00
2471	24-06-2021 13:44	72,00
2472	24-06-2021 13:44	72,00
2473	24-06-2021 13:44	72,00

2474	24-06-2021 13:44	72,00
2475	24-06-2021 13:44	72,00
2476	24-06-2021 13:44	72,00
2477	24-06-2021 13:44	72,00
2478	24-06-2021 13:44	72,00
2479	24-06-2021 13:44	72,00
2480	24-06-2021 13:44	72,00
2481	24-06-2021 13:44	72,00
2482	24-06-2021 13:44	72,00
2483	24-06-2021 13:45	72,00
2484	24-06-2021 13:45	72,00
2485	24-06-2021 13:45	72,00
2486	24-06-2021 13:45	72,00
2487	24-06-2021 13:45	72,00
2488	24-06-2021 13:45	72,00
2489	24-06-2021 13:45	72,00
2490	24-06-2021 13:45	72,00
2491	24-06-2021 13:45	72,00
2492	24-06-2021 13:45	72,00
2493	24-06-2021 13:45	72,00
2494	24-06-2021 13:45	72,00
2495	24-06-2021 13:45	72,00
2496	24-06-2021 13:45	72,00
2497	24-06-2021 13:46	72,00
2498	24-06-2021 13:46	72,00
2499	24-06-2021 13:46	72,00
2500	24-06-2021 13:46	72,00
2501	24-06-2021 13:46	72,00
2502	24-06-2021 13:46	72,00
2503	24-06-2021 13:46	72,00
2504	24-06-2021 13:46	72,00
2505	24-06-2021 13:46	72,00
2506	24-06-2021 13:47	71,00
2507	24-06-2021 13:47	71,00
2508	24-06-2021 13:47	71,00
2509	24-06-2021 13:47	71,00
2510	24-06-2021 13:47	71,00
2511	24-06-2021 13:47	71,00
2512	24-06-2021 13:47	71,00
2513	24-06-2021 13:47	71,00
2514	24-06-2021 13:47	71,00
2515	24-06-2021 13:47	71,00

2516	24-06-2021 13:47	71,00
2517	24-06-2021 13:47	71,00
2518	24-06-2021 13:48	71,00
2519	24-06-2021 13:48	71,00
2520	24-06-2021 13:48	71,00
2521	24-06-2021 13:48	71,00
2522	24-06-2021 13:48	71,00
2523	24-06-2021 13:48	71,00
2524	24-06-2021 13:48	71,00
2525	24-06-2021 13:48	71,00
2526	24-06-2021 13:48	71,00
2527	24-06-2021 13:48	71,00
2528	24-06-2021 13:48	71,00
2529	24-06-2021 13:48	71,00
2530	24-06-2021 13:48	71,00
2531	24-06-2021 13:48	71,00
2532	24-06-2021 13:48	72,00
2533	24-06-2021 13:48	72,00
2534	24-06-2021 13:48	72,00
2535	24-06-2021 13:48	72,00
2536	24-06-2021 13:48	72,00
2537	24-06-2021 13:48	72,00
2538	24-06-2021 13:48	72,00
2539	24-06-2021 13:48	72,00
2540	24-06-2021 13:49	72,00
2541	24-06-2021 13:49	72,00
2542	24-06-2021 13:49	72,00
2543	24-06-2021 13:49	72,00
2544	24-06-2021 13:49	72,00
2545	24-06-2021 13:49	72,00
2546	24-06-2021 13:49	72,00
2547	24-06-2021 13:49	72,00
2548	24-06-2021 13:49	72,00
2549	24-06-2021 13:49	72,00
2550	24-06-2021 13:49	72,00
2551	24-06-2021 13:49	72,00
2552	24-06-2021 13:49	72,00
2553	24-06-2021 13:50	72,00
2554	24-06-2021 13:50	72,00
2555	24-06-2021 13:50	71,00
2556	24-06-2021 13:50	71,00
2557	24-06-2021 13:50	71,00

2558	24-06-2021 13:50	71,00
2559	24-06-2021 13:50	71,00
2560	24-06-2021 13:50	71,00
2561	24-06-2021 13:50	71,00
2562	24-06-2021 13:51	71,00
2563	24-06-2021 13:51	71,00
2564	24-06-2021 13:51	71,00
2565	24-06-2021 13:51	71,00
2566	24-06-2021 13:51	71,00
2567	24-06-2021 13:51	71,00
2568	24-06-2021 13:51	71,00
2569	24-06-2021 13:51	71,00
2570	24-06-2021 13:51	71,00
2571	24-06-2021 13:51	71,00
2572	24-06-2021 13:51	71,00
2573	24-06-2021 13:51	71,00
2574	24-06-2021 13:51	71,00
2575	24-06-2021 13:51	71,00
2576	24-06-2021 13:51	71,00
2577	24-06-2021 13:52	71,00
2578	24-06-2021 13:52	71,00
2579	24-06-2021 13:52	71,00
2580	24-06-2021 13:52	71,00
2581	24-06-2021 13:52	71,00
2582	24-06-2021 13:52	71,00
2583	24-06-2021 13:52	71,00
2584	24-06-2021 13:52	71,00
2585	24-06-2021 13:52	71,00
2586	24-06-2021 13:53	71,00
2587	24-06-2021 13:53	71,00
2588	24-06-2021 13:53	71,00
2589	24-06-2021 13:53	71,00
2590	24-06-2021 13:53	71,00
2591	24-06-2021 13:53	71,00
2592	24-06-2021 13:53	71,00
2593	24-06-2021 13:53	71,00
2594	24-06-2021 13:53	71,00
2595	24-06-2021 13:53	71,00
2596	24-06-2021 13:53	71,00
2597	24-06-2021 13:53	71,00
2598	24-06-2021 13:53	71,00
2599	24-06-2021 13:53	71,00

2600	24-06-2021 13:54	72,00
2601	24-06-2021 13:54	72,00
2602	24-06-2021 13:54	72,00
2603	24-06-2021 13:54	72,00
2604	24-06-2021 13:54	72,00
2605	24-06-2021 13:54	72,00
2606	24-06-2021 13:54	72,00
2607	24-06-2021 13:54	72,00
2608	24-06-2021 13:54	72,00
2609	24-06-2021 13:54	72,00
2610	24-06-2021 13:54	72,00
2611	24-06-2021 13:54	72,00
2612	24-06-2021 13:54	72,00
2613	24-06-2021 13:54	72,00
2614	24-06-2021 13:54	72,00
2615	24-06-2021 13:54	72,00
2616	24-06-2021 13:54	72,00
2617	24-06-2021 13:54	72,00
2618	24-06-2021 13:55	72,00
2619	24-06-2021 13:55	72,00
2620	24-06-2021 13:55	72,00
2621	24-06-2021 13:55	72,00
2622	24-06-2021 13:55	72,00
2623	24-06-2021 13:55	72,00
2624	24-06-2021 13:55	72,00
2625	24-06-2021 13:55	72,00
2626	24-06-2021 13:55	72,00
2627	24-06-2021 13:55	72,00
2628	24-06-2021 13:55	72,00
2629	24-06-2021 13:55	72,00
2630	24-06-2021 13:55	72,00
2631	24-06-2021 13:55	72,00
2632	24-06-2021 13:56	72,00
2633	24-06-2021 13:56	72,00
2634	24-06-2021 13:56	72,00
2635	24-06-2021 13:56	72,00
2636	24-06-2021 13:56	72,00
2637	24-06-2021 13:56	72,00
2638	24-06-2021 13:56	72,00
2639	24-06-2021 13:57	72,00
2640	24-06-2021 13:57	72,00
2641	24-06-2021 13:57	72,00

2642	24-06-2021 13:57	72,00
2643	24-06-2021 13:57	72,00
2644	24-06-2021 13:57	72,00
2645	24-06-2021 13:57	72,00
2646	24-06-2021 13:57	72,00
2647	24-06-2021 13:57	72,00
2648	24-06-2021 13:57	72,00
2649	24-06-2021 13:57	72,00
2650	24-06-2021 13:58	72,00
2651	24-06-2021 13:58	72,00
2652	24-06-2021 13:58	72,00
2653	24-06-2021 13:58	72,00
2654	24-06-2021 13:58	72,00
2655	24-06-2021 13:58	72,00
2656	24-06-2021 13:58	72,00
2657	24-06-2021 13:58	72,00
2658	24-06-2021 13:58	72,00
2659	24-06-2021 13:58	72,00
2660	24-06-2021 13:58	72,00
2661	24-06-2021 13:58	72,00
2662	24-06-2021 13:58	72,00
2663	24-06-2021 13:58	72,00
2664	24-06-2021 13:58	72,00
2665	24-06-2021 13:59	72,00
2666	24-06-2021 13:59	72,00
2667	24-06-2021 13:59	72,00
2668	24-06-2021 13:59	72,00
2669	24-06-2021 13:59	72,00
2670	24-06-2021 13:59	72,00
2671	24-06-2021 13:59	72,00
2672	24-06-2021 13:59	72,00
2673	24-06-2021 14:00	72,00
2674	24-06-2021 14:00	72,00
2675	24-06-2021 14:00	72,00
2676	24-06-2021 14:00	72,00
2677	24-06-2021 14:00	72,00
2678	24-06-2021 14:00	72,00
2679	24-06-2021 14:00	72,00
2680	24-06-2021 14:00	72,00
2681	24-06-2021 14:00	72,00
2682	24-06-2021 14:00	72,00
2683	24-06-2021 14:00	72,00

2684	24-06-2021 14:00	72,00
2685	24-06-2021 14:00	72,00
2686	24-06-2021 14:00	72,00
2687	24-06-2021 14:00	72,00
2688	24-06-2021 14:00	72,00
2689	24-06-2021 14:00	72,00
2690	24-06-2021 14:01	72,00
2691	24-06-2021 14:01	72,00
2692	24-06-2021 14:01	72,00
2693	24-06-2021 14:01	72,00
2694	24-06-2021 14:01	72,00
2695	24-06-2021 14:01	72,00
2696	24-06-2021 14:01	72,00
2697	24-06-2021 14:01	72,00
2698	24-06-2021 14:01	72,00
2699	24-06-2021 14:01	72,00
2700	24-06-2021 14:01	72,00
2701	24-06-2021 14:01	72,00
2702	24-06-2021 14:01	72,00
2703	24-06-2021 14:01	72,00
2704	24-06-2021 14:01	72,00
2705	24-06-2021 14:01	72,00
2706	24-06-2021 14:01	72,00
2707	24-06-2021 14:02	72,00
2708	24-06-2021 14:02	72,00
2709	24-06-2021 14:02	72,00
2710	24-06-2021 14:02	72,00
2711	24-06-2021 14:02	72,00
2712	24-06-2021 14:02	72,00
2713	24-06-2021 14:02	72,00
2714	24-06-2021 14:02	72,00
2715	24-06-2021 14:02	72,00
2716	24-06-2021 14:03	72,00
2717	24-06-2021 14:03	72,00
2718	24-06-2021 14:03	72,00
2719	24-06-2021 14:03	72,00
2720	24-06-2021 14:03	72,00
2721	24-06-2021 14:03	72,00
2722	24-06-2021 14:03	72,00
2723	24-06-2021 14:03	72,00
2724	24-06-2021 14:03	72,00
2725	24-06-2021 14:03	72,00

2726	24-06-2021 14:03	72,00
2727	24-06-2021 14:03	72,00
2728	24-06-2021 14:03	72,00
2729	24-06-2021 14:03	72,00
2730	24-06-2021 14:03	72,00
2731	24-06-2021 14:03	72,00
2732	24-06-2021 14:03	72,00
2733	24-06-2021 14:03	72,00
2734	24-06-2021 14:03	72,00
2735	24-06-2021 14:03	72,00
2736	24-06-2021 14:03	72,00
2737	24-06-2021 14:04	72,00
2738	24-06-2021 14:04	72,00
2739	24-06-2021 14:04	72,00
2740	24-06-2021 14:04	72,00
2741	24-06-2021 14:04	72,00
2742	24-06-2021 14:04	72,00
2743	24-06-2021 14:04	72,00
2744	24-06-2021 14:04	72,00
2745	24-06-2021 14:04	72,00
2746	24-06-2021 14:05	72,00
2747	24-06-2021 14:05	72,00
2748	24-06-2021 14:05	72,00
2749	24-06-2021 14:05	72,00
2750	24-06-2021 14:05	72,00
2751	24-06-2021 14:05	72,00
2752	24-06-2021 14:05	72,00
2753	24-06-2021 14:05	72,00
2754	24-06-2021 14:05	72,00
2755	24-06-2021 14:05	72,00
2756	24-06-2021 14:05	72,00
2757	24-06-2021 14:06	72,00
2758	24-06-2021 14:06	72,00
2759	24-06-2021 14:06	72,00
2760	24-06-2021 14:06	72,00
2761	24-06-2021 14:06	72,00
2762	24-06-2021 14:06	72,00
2763	24-06-2021 14:06	72,00
2764	24-06-2021 14:06	72,00
2765	24-06-2021 14:06	72,00
2766	24-06-2021 14:06	72,00
2767	24-06-2021 14:06	72,00



2768	24-06-2021 14:06	72,00
2769	24-06-2021 14:06	72,00
2770	24-06-2021 14:06	72,00
2771	24-06-2021 14:06	72,00
2772	24-06-2021 14:07	72,00
2773	24-06-2021 14:07	72,00
2774	24-06-2021 14:07	72,00
2775	24-06-2021 14:07	72,00
2776	24-06-2021 14:07	72,00
2777	24-06-2021 14:07	72,00
2778	24-06-2021 14:07	72,00
2779	24-06-2021 14:07	72,00
2780	24-06-2021 14:07	72,00
2781	24-06-2021 14:07	72,00
2782	24-06-2021 14:07	72,00
2783	24-06-2021 14:07	72,00
2784	24-06-2021 14:07	72,00
2785	24-06-2021 14:07	72,00
2786	24-06-2021 14:07	72,00
2787	24-06-2021 14:08	72,00
2788	24-06-2021 14:08	72,00
2789	24-06-2021 14:08	72,00
2790	24-06-2021 14:08	72,00
2791	24-06-2021 14:08	72,00
2792	24-06-2021 14:08	72,00
2793	24-06-2021 14:08	72,00
2794	24-06-2021 14:08	73,00
2795	24-06-2021 14:08	73,00
2796	24-06-2021 14:08	73,00
2797	24-06-2021 14:08	73,00
2798	24-06-2021 14:08	73,00
2799	24-06-2021 14:09	73,00
2800	24-06-2021 14:09	73,00
2801	24-06-2021 14:09	73,00
2802	24-06-2021 14:09	73,00
2803	24-06-2021 14:09	73,00
2804	24-06-2021 14:09	73,00
2805	24-06-2021 14:09	73,00
2806	24-06-2021 14:09	73,00
2807	24-06-2021 14:09	73,00
2808	24-06-2021 14:10	73,00
2809	24-06-2021 14:10	73,00

2810	24-06-2021 14:10	73,00
2811	24-06-2021 14:10	74,00
2812	24-06-2021 14:10	74,00
2813	24-06-2021 14:10	74,00
2814	24-06-2021 14:10	74,00
2815	24-06-2021 14:10	74,00
2816	24-06-2021 14:10	74,00
2817	24-06-2021 14:10	74,00
2818	24-06-2021 14:10	74,00
2819	24-06-2021 14:10	74,00
2820	24-06-2021 14:10	74,00
2821	24-06-2021 14:10	74,00
2822	24-06-2021 14:11	74,00
2823	24-06-2021 14:11	74,00
2824	24-06-2021 14:11	74,00
2825	24-06-2021 14:11	74,00
2826	24-06-2021 14:11	74,00
2827	24-06-2021 14:11	74,00
2828	24-06-2021 14:11	74,00
2829	24-06-2021 14:11	74,00
2830	24-06-2021 14:11	74,00
2831	24-06-2021 14:11	74,00
2832	24-06-2021 14:11	74,00
2833	24-06-2021 14:11	74,00
2834	24-06-2021 14:11	74,00
2835	24-06-2021 14:12	74,00
2836	24-06-2021 14:12	74,00
2837	24-06-2021 14:12	74,00
2838	24-06-2021 14:12	74,00
2839	24-06-2021 14:12	74,00
2840	24-06-2021 14:12	74,00
2841	24-06-2021 14:12	74,00
2842	24-06-2021 14:12	75,00
2843	24-06-2021 14:12	75,00
2844	24-06-2021 14:12	75,00
2845	24-06-2021 14:12	75,00
2846	24-06-2021 14:13	75,00
2847	24-06-2021 14:13	75,00
2848	24-06-2021 14:13	75,00
2849	24-06-2021 14:13	75,00
2850	24-06-2021 14:13	75,00
2851	24-06-2021 14:13	75,00

2852	24-06-2021 14:13	75,00
2853	24-06-2021 14:13	75,00
2854	24-06-2021 14:14	75,00
2855	24-06-2021 14:14	75,00
2856	24-06-2021 14:14	75,00
2857	24-06-2021 14:14	75,00
2858	24-06-2021 14:14	75,00
2859	24-06-2021 14:14	75,00
2860	24-06-2021 14:14	75,00
2861	24-06-2021 14:14	75,00
2862	24-06-2021 14:14	75,00
2863	24-06-2021 14:14	75,00
2864	24-06-2021 14:14	75,00
2865	24-06-2021 14:14	75,00
2866	24-06-2021 14:14	75,00
2867	24-06-2021 14:14	75,00
2868	24-06-2021 14:14	75,00
2869	24-06-2021 14:14	75,00
2870	24-06-2021 14:15	75,00
2871	24-06-2021 14:15	75,00
2872	24-06-2021 14:15	75,00
2873	24-06-2021 14:15	75,00
2874	24-06-2021 14:15	75,00
2875	24-06-2021 14:15	75,00
2876	24-06-2021 14:15	75,00
2877	24-06-2021 14:15	75,00
2878	24-06-2021 14:15	75,00
2879	24-06-2021 14:15	75,00
2880	24-06-2021 14:15	75,00
2881	24-06-2021 14:15	75,00
2882	24-06-2021 14:15	75,00
2883	24-06-2021 14:15	75,00
2884	24-06-2021 14:16	75,00
2885	24-06-2021 14:16	75,00
2886	24-06-2021 14:16	75,00
2887	24-06-2021 14:16	75,00
2888	24-06-2021 14:16	75,00
2889	24-06-2021 14:16	75,00
2890	24-06-2021 14:16	75,00
2891	24-06-2021 14:16	75,00
2892	24-06-2021 14:16	75,00
2893	24-06-2021 14:17	75,00

2894	24-06-2021 14:17	75,00
2895	24-06-2021 14:17	75,00
2896	24-06-2021 14:17	75,00
2897	24-06-2021 14:17	75,00
2898	24-06-2021 14:17	75,00
2899	24-06-2021 14:17	75,00
2900	24-06-2021 14:17	75,00
2901	24-06-2021 14:17	75,00
2902	24-06-2021 14:18	75,00
2903	24-06-2021 14:18	75,00
2904	24-06-2021 14:18	75,00
2905	24-06-2021 14:18	75,00
2906	24-06-2021 14:18	75,00
2907	24-06-2021 14:18	75,00
2908	24-06-2021 14:18	75,00
2909	24-06-2021 14:18	75,00
2910	24-06-2021 14:18	75,00
2911	24-06-2021 14:18	75,00
2912	24-06-2021 14:18	75,00
2913	24-06-2021 14:18	75,00
2914	24-06-2021 14:18	75,00
2915	24-06-2021 14:18	75,00
2916	24-06-2021 14:18	75,00
2917	24-06-2021 14:19	75,00
2918	24-06-2021 14:19	75,00
2919	24-06-2021 14:19	75,00
2920	24-06-2021 14:19	75,00
2921	24-06-2021 14:19	75,00
2922	24-06-2021 14:19	75,00
2923	24-06-2021 14:19	74,00
2924	24-06-2021 14:19	74,00
2925	24-06-2021 14:19	74,00
2926	24-06-2021 14:19	74,00
2927	24-06-2021 14:19	74,00
2928	24-06-2021 14:19	74,00
2929	24-06-2021 14:19	74,00
2930	24-06-2021 14:19	74,00
2931	24-06-2021 14:19	74,00
2932	24-06-2021 14:20	74,00
2933	24-06-2021 14:20	74,00
2934	24-06-2021 14:20	74,00
2935	24-06-2021 14:20	74,00

2936	24-06-2021 14:20	74,00
2937	24-06-2021 14:20	75,00
2938	24-06-2021 14:20	75,00
2939	24-06-2021 14:20	75,00
2940	24-06-2021 14:20	75,00
2941	24-06-2021 14:20	75,00
2942	24-06-2021 14:20	75,00
2943	24-06-2021 14:20	75,00
2944	24-06-2021 14:20	75,00
2945	24-06-2021 14:20	75,00
2946	24-06-2021 14:20	75,00
2947	24-06-2021 14:21	75,00
2948	24-06-2021 14:21	75,00
2949	24-06-2021 14:21	75,00
2950	24-06-2021 14:21	74,00
2951	24-06-2021 14:21	74,00
2952	24-06-2021 14:21	74,00
2953	24-06-2021 14:21	74,00
2954	24-06-2021 14:21	74,00
2955	24-06-2021 14:21	74,00
2956	24-06-2021 14:21	74,00
2957	24-06-2021 14:21	74,00
2958	24-06-2021 14:22	74,00
2959	24-06-2021 14:22	74,00
2960	24-06-2021 14:22	74,00
2961	24-06-2021 14:22	74,00
2962	24-06-2021 14:22	74,00
2963	24-06-2021 14:22	74,00
2964	24-06-2021 14:22	74,00
2965	24-06-2021 14:22	74,00
2966	24-06-2021 14:22	74,00
2967	24-06-2021 14:22	74,00
2968	24-06-2021 14:22	74,00
2969	24-06-2021 14:23	74,00
2970	24-06-2021 14:23	74,00
2971	24-06-2021 14:23	74,00
2972	24-06-2021 14:23	74,00
2973	24-06-2021 14:23	74,00
2974	24-06-2021 14:23	74,00
2975	24-06-2021 14:23	74,00
2976	24-06-2021 14:23	74,00
2977	24-06-2021 14:23	74,00

2978	24-06-2021 14:23	74,00
2979	24-06-2021 14:23	74,00
2980	24-06-2021 14:23	74,00
2981	24-06-2021 14:23	74,00
2982	24-06-2021 14:23	74,00
2983	24-06-2021 14:23	74,00
2984	24-06-2021 14:23	74,00
2985	24-06-2021 14:24	74,00
2986	24-06-2021 14:24	74,00
2987	24-06-2021 14:24	74,00
2988	24-06-2021 14:24	74,00
2989	24-06-2021 14:24	74,00
2990	24-06-2021 14:24	74,00
2991	24-06-2021 14:24	74,00
2992	24-06-2021 14:24	74,00
2993	24-06-2021 14:24	74,00
2994	24-06-2021 14:24	75,00
2995	24-06-2021 14:24	75,00
2996	24-06-2021 14:24	75,00
2997	24-06-2021 14:24	75,00
2998	24-06-2021 14:24	75,00
2999	24-06-2021 14:24	75,00
3000	24-06-2021 14:25	75,00
3001	24-06-2021 14:25	75,00
3002	24-06-2021 14:25	75,00
3003	24-06-2021 14:25	75,00
3004	24-06-2021 14:25	75,00
3005	24-06-2021 14:25	75,00
3006	24-06-2021 14:25	75,00
3007	24-06-2021 14:25	75,00
3008	24-06-2021 14:25	75,00
3009	24-06-2021 14:25	75,00
3010	24-06-2021 14:25	75,00
3011	24-06-2021 14:25	75,00
3012	24-06-2021 14:25	75,00
3013	24-06-2021 14:25	75,00
3014	24-06-2021 14:25	75,00
3015	24-06-2021 14:25	75,00
3016	24-06-2021 14:25	75,00
3017	24-06-2021 14:26	75,00
3018	24-06-2021 14:26	75,00
3019	24-06-2021 14:26	75,00

3020	24-06-2021 14:26	75,00
3021	24-06-2021 14:26	75,00
3022	24-06-2021 14:26	75,00
3023	24-06-2021 14:26	75,00
3024	24-06-2021 14:26	75,00
3025	24-06-2021 14:27	75,00
3026	24-06-2021 14:27	75,00
3027	24-06-2021 14:27	75,00
3028	24-06-2021 14:27	75,00
3029	24-06-2021 14:27	75,00
3030	24-06-2021 14:27	75,00
3031	24-06-2021 14:27	75,00
3032	24-06-2021 14:27	75,00
3033	24-06-2021 14:27	75,00
3034	24-06-2021 14:27	75,00
3035	24-06-2021 14:27	75,00
3036	24-06-2021 14:27	75,00
3037	24-06-2021 14:27	75,00
3038	24-06-2021 14:27	75,00
3039	24-06-2021 14:28	75,00
3040	24-06-2021 14:28	75,00
3041	24-06-2021 14:28	75,00
3042	24-06-2021 14:28	75,00
3043	24-06-2021 14:28	75,00
3044	24-06-2021 14:28	75,00
3045	24-06-2021 14:28	75,00
3046	24-06-2021 14:28	75,00
3047	24-06-2021 14:28	75,00
3048	24-06-2021 14:28	75,00
3049	24-06-2021 14:28	75,00
3050	24-06-2021 14:28	75,00
3051	24-06-2021 14:28	75,00
3052	24-06-2021 14:28	75,00
3053	24-06-2021 14:28	75,00
3054	24-06-2021 14:28	75,00
3055	24-06-2021 14:29	75,00
3056	24-06-2021 14:29	75,00
3057	24-06-2021 14:29	75,00
3058	24-06-2021 14:29	75,00
3059	24-06-2021 14:29	75,00
3060	24-06-2021 14:29	75,00
3061	24-06-2021 14:29	75,00

3062	24-06-2021 14:29	75,00
3063	24-06-2021 14:29	75,00
3064	24-06-2021 14:29	75,00
3065	24-06-2021 14:29	75,00
3066	24-06-2021 14:29	75,00
3067	24-06-2021 14:29	75,00
3068	24-06-2021 14:29	75,00
3069	24-06-2021 14:29	75,00
3070	24-06-2021 14:30	75,00
3071	24-06-2021 14:30	75,00
3072	24-06-2021 14:30	75,00
3073	24-06-2021 14:30	75,00
3074	24-06-2021 14:30	75,00
3075	24-06-2021 14:30	75,00
3076	24-06-2021 14:30	75,00
3077	24-06-2021 14:30	75,00
3078	24-06-2021 14:30	75,00
3079	24-06-2021 14:30	75,00
3080	24-06-2021 14:30	75,00
3081	24-06-2021 14:30	75,00
3082	24-06-2021 14:30	75,00
3083	24-06-2021 14:30	75,00
3084	24-06-2021 14:30	75,00
3085	24-06-2021 14:30	75,00
3086	24-06-2021 14:30	75,00
3087	24-06-2021 14:31	75,00
3088	24-06-2021 14:31	75,00
3089	24-06-2021 14:31	75,00
3090	24-06-2021 14:31	75,00
3091	24-06-2021 14:31	75,00
3092	24-06-2021 14:31	75,00
3093	24-06-2021 14:31	76,00
3094	24-06-2021 14:31	76,00
3095	24-06-2021 14:31	76,00
3096	24-06-2021 14:31	76,00
3097	24-06-2021 14:31	76,00
3098	24-06-2021 14:31	76,00
3099	24-06-2021 14:31	76,00
3100	24-06-2021 14:31	76,00
3101	24-06-2021 14:31	76,00
3102	24-06-2021 14:31	76,00
3103	24-06-2021 14:31	76,00

3104	24-06-2021 14:31	76,00
3105	24-06-2021 14:32	76,00
3106	24-06-2021 14:32	76,00
3107	24-06-2021 14:32	76,00
3108	24-06-2021 14:32	76,00
3109	24-06-2021 14:32	76,00
3110	24-06-2021 14:32	76,00
3111	24-06-2021 14:32	76,00
3112	24-06-2021 14:32	76,00
3113	24-06-2021 14:32	76,00
3114	24-06-2021 14:32	76,00
3115	24-06-2021 14:32	76,00
3116	24-06-2021 14:32	76,00
3117	24-06-2021 14:32	76,00
3118	24-06-2021 14:32	76,00
3119	24-06-2021 14:32	76,00
3120	24-06-2021 14:32	76,00
3121	24-06-2021 14:32	76,00
3122	24-06-2021 14:33	76,00
3123	24-06-2021 14:33	76,00
3124	24-06-2021 14:33	76,00
3125	24-06-2021 14:33	76,00
3126	24-06-2021 14:33	76,00
3127	24-06-2021 14:33	77,00
3128	24-06-2021 14:33	77,00
3129	24-06-2021 14:33	77,00
3130	24-06-2021 14:33	77,00
3131	24-06-2021 14:33	77,00
3132	24-06-2021 14:33	77,00
3133	24-06-2021 14:33	77,00
3134	24-06-2021 14:33	77,00
3135	24-06-2021 14:33	77,00
3136	24-06-2021 14:33	77,00
3137	24-06-2021 14:33	77,00
3138	24-06-2021 14:33	77,00
3139	24-06-2021 14:33	77,00
3140	24-06-2021 14:34	76,00
3141	24-06-2021 14:34	76,00
3142	24-06-2021 14:34	76,00
3143	24-06-2021 14:34	76,00
3144	24-06-2021 14:34	76,00
3145	24-06-2021 14:34	76,00

3146	24-06-2021 14:34	76,00
3147	24-06-2021 14:34	76,00
3148	24-06-2021 14:34	76,00
3149	24-06-2021 14:34	76,00
3150	24-06-2021 14:34	76,00
3151	24-06-2021 14:34	76,00
3152	24-06-2021 14:34	76,00
3153	24-06-2021 14:35	76,00
3154	24-06-2021 14:35	76,00
3155	24-06-2021 14:35	76,00
3156	24-06-2021 14:35	76,00
3157	24-06-2021 14:35	76,00
3158	24-06-2021 14:35	76,00
3159	24-06-2021 14:35	76,00
3160	24-06-2021 14:35	76,00
3161	24-06-2021 14:35	76,00
3162	24-06-2021 14:36	76,00
3163	24-06-2021 14:36	76,00
3164	24-06-2021 14:36	76,00
3165	24-06-2021 14:36	76,00
3166	24-06-2021 14:36	76,00
3167	24-06-2021 14:36	76,00
3168	24-06-2021 14:36	76,00
3169	24-06-2021 14:36	76,00
3170	24-06-2021 14:36	76,00
3171	24-06-2021 14:37	76,00
3172	24-06-2021 14:37	76,00
3173	24-06-2021 14:37	76,00
3174	24-06-2021 14:37	76,00
3175	24-06-2021 14:37	76,00
3176	24-06-2021 14:37	76,00
3177	24-06-2021 14:37	76,00
3178	24-06-2021 14:37	76,00
3179	24-06-2021 14:37	76,00
3180	24-06-2021 14:37	76,00
3181	24-06-2021 14:37	76,00
3182	24-06-2021 14:37	76,00
3183	24-06-2021 14:37	76,00
3184	24-06-2021 14:37	76,00
3185	24-06-2021 14:38	76,00
3186	24-06-2021 14:38	76,00
3187	24-06-2021 14:38	76,00

3188	24-06-2021 14:38	76,00
3189	24-06-2021 14:38	76,00
3190	24-06-2021 14:38	76,00
3191	24-06-2021 14:38	76,00
3192	24-06-2021 14:38	76,00
3193	24-06-2021 14:38	76,00
3194	24-06-2021 14:38	76,00
3195	24-06-2021 14:38	76,00
3196	24-06-2021 14:38	76,00
3197	24-06-2021 14:38	76,00
3198	24-06-2021 14:38	76,00
3199	24-06-2021 14:38	76,00
3200	24-06-2021 14:38	76,00
3201	24-06-2021 14:38	76,00
3202	24-06-2021 14:39	76,00
3203	24-06-2021 14:39	76,00
3204	24-06-2021 14:39	76,00
3205	24-06-2021 14:39	76,00
3206	24-06-2021 14:39	76,00
3207	24-06-2021 14:39	76,00
3208	24-06-2021 14:39	76,00
3209	24-06-2021 14:39	76,00
3210	24-06-2021 14:39	76,00
3211	24-06-2021 14:39	76,00
3212	24-06-2021 14:39	76,00
3213	24-06-2021 14:39	76,00
3214	24-06-2021 14:39	76,00
3215	24-06-2021 14:39	76,00
3216	24-06-2021 14:39	76,00
3217	24-06-2021 14:39	76,00
3218	24-06-2021 14:40	76,00
3219	24-06-2021 14:40	76,00
3220	24-06-2021 14:40	76,00
3221	24-06-2021 14:40	76,00
3222	24-06-2021 14:40	76,00
3223	24-06-2021 14:40	76,00
3224	24-06-2021 14:40	76,00
3225	24-06-2021 14:40	76,00
3226	24-06-2021 14:40	76,00
3227	24-06-2021 14:40	76,00
3228	24-06-2021 14:40	76,00
3229	24-06-2021 14:40	76,00

3230	24-06-2021 14:40	76,00
3231	24-06-2021 14:40	76,00
3232	24-06-2021 14:41	76,00
3233	24-06-2021 14:41	76,00
3234	24-06-2021 14:41	76,00
3235	24-06-2021 14:41	76,00
3236	24-06-2021 14:41	76,00
3237	24-06-2021 14:41	76,00
3238	24-06-2021 14:41	76,00
3239	24-06-2021 14:41	76,00
3240	24-06-2021 14:41	76,00
3241	24-06-2021 14:41	76,00
3242	24-06-2021 14:41	76,00
3243	24-06-2021 14:41	76,00
3244	24-06-2021 14:41	76,00
3245	24-06-2021 14:41	76,00
3246	24-06-2021 14:42	76,00
3247	24-06-2021 14:42	76,00
3248	24-06-2021 14:42	76,00
3249	24-06-2021 14:42	76,00
3250	24-06-2021 14:42	76,00
3251	24-06-2021 14:42	76,00
3252	24-06-2021 14:42	76,00
3253	24-06-2021 14:42	76,00
3254	24-06-2021 14:42	76,00
3255	24-06-2021 14:42	76,00
3256	24-06-2021 14:42	76,00
3257	24-06-2021 14:42	76,00
3258	24-06-2021 14:42	76,00
3259	24-06-2021 14:42	76,00
3260	24-06-2021 14:42	76,00
3261	24-06-2021 14:42	76,00
3262	24-06-2021 14:42	76,00
3263	24-06-2021 14:42	76,00
3264	24-06-2021 14:42	76,00
3265	24-06-2021 14:42	76,00
3266	24-06-2021 14:42	76,00
3267	24-06-2021 14:43	76,00
3268	24-06-2021 14:43	76,00
3269	24-06-2021 14:43	76,00
3270	24-06-2021 14:43	76,00
3271	24-06-2021 14:43	76,00

3272	24-06-2021 14:43	76,00
3273	24-06-2021 14:43	76,00
3274	24-06-2021 14:43	76,00
3275	24-06-2021 14:43	76,00
3276	24-06-2021 14:43	76,00
3277	24-06-2021 14:43	76,00
3278	24-06-2021 14:43	76,00
3279	24-06-2021 14:43	76,00
3280	24-06-2021 14:43	76,00
3281	24-06-2021 14:43	76,00
3282	24-06-2021 14:44	76,00
3283	24-06-2021 14:44	77,00
3284	24-06-2021 14:44	77,00
3285	24-06-2021 14:44	77,00
3286	24-06-2021 14:44	77,00
3287	24-06-2021 14:44	77,00
3288	24-06-2021 14:44	77,00
3289	24-06-2021 14:44	77,00
3290	24-06-2021 14:44	77,00
3291	24-06-2021 14:44	77,00
3292	24-06-2021 14:44	77,00
3293	24-06-2021 14:44	77,00
3294	24-06-2021 14:44	77,00
3295	24-06-2021 14:44	77,00
3296	24-06-2021 14:45	77,00
3297	24-06-2021 14:45	77,00
3298	24-06-2021 14:45	77,00
3299	24-06-2021 14:45	77,00
3300	24-06-2021 14:45	77,00
3301	24-06-2021 14:45	77,00
3302	24-06-2021 14:45	77,00
3303	24-06-2021 14:45	77,00
3304	24-06-2021 14:45	77,00
3305	24-06-2021 14:46	76,00
3306	24-06-2021 14:46	76,00
3307	24-06-2021 14:46	76,00
3308	24-06-2021 14:46	76,00
3309	24-06-2021 14:46	76,00
3310	24-06-2021 14:46	76,00
3311	24-06-2021 14:46	76,00
3312	24-06-2021 14:46	76,00
3313	24-06-2021 14:46	76,00

3314	24-06-2021 14:46	76,00
3315	24-06-2021 14:46	76,00
3316	24-06-2021 14:46	76,00
3317	24-06-2021 14:46	76,00
3318	24-06-2021 14:46	76,00
3319	24-06-2021 14:46	76,00
3320	24-06-2021 14:47	76,00
3321	24-06-2021 14:47	76,00
3322	24-06-2021 14:47	76,00
3323	24-06-2021 14:47	76,00
3324	24-06-2021 14:47	76,00
3325	24-06-2021 14:47	76,00
3326	24-06-2021 14:47	76,00
3327	24-06-2021 14:47	76,00
3328	24-06-2021 14:47	76,00
3329	24-06-2021 14:47	76,00
3330	24-06-2021 14:47	76,00
3331	24-06-2021 14:47	76,00
3332	24-06-2021 14:47	77,00
3333	24-06-2021 14:47	77,00
3334	24-06-2021 14:47	77,00
3335	24-06-2021 14:48	77,00
3336	24-06-2021 14:48	77,00
3337	24-06-2021 14:48	77,00
3338	24-06-2021 14:48	77,00
3339	24-06-2021 14:48	77,00
3340	24-06-2021 14:48	77,00
3341	24-06-2021 14:48	77,00
3342	24-06-2021 14:48	77,00
3343	24-06-2021 14:48	77,00
3344	24-06-2021 14:48	77,00
3345	24-06-2021 14:48	77,00
3346	24-06-2021 14:49	77,00
3347	24-06-2021 14:49	77,00
3348	24-06-2021 14:49	77,00
3349	24-06-2021 14:49	77,00
3350	24-06-2021 14:49	77,00
3351	24-06-2021 14:49	77,00
3352	24-06-2021 14:49	77,00
3353	24-06-2021 14:49	77,00
3354	24-06-2021 14:49	77,00
3355	24-06-2021 14:49	77,00

3356	24-06-2021 14:49	77,00
3357	24-06-2021 14:49	77,00
3358	24-06-2021 14:49	77,00
3359	24-06-2021 14:49	77,00
3360	24-06-2021 14:49	77,00
3361	24-06-2021 14:49	77,00
3362	24-06-2021 14:50	77,00
3363	24-06-2021 14:50	77,00
3364	24-06-2021 14:50	77,00
3365	24-06-2021 14:50	77,00
3366	24-06-2021 14:50	77,00
3367	24-06-2021 14:50	77,00
3368	24-06-2021 14:50	77,00
3369	24-06-2021 14:50	77,00
3370	24-06-2021 14:50	77,00
3371	24-06-2021 14:50	77,00
3372	24-06-2021 14:50	77,00
3373	24-06-2021 14:50	77,00
3374	24-06-2021 14:50	77,00
3375	24-06-2021 14:50	77,00
3376	24-06-2021 14:50	77,00
3377	24-06-2021 14:50	77,00
3378	24-06-2021 14:50	77,00
3379	24-06-2021 14:51	77,00
3380	24-06-2021 14:51	77,00
3381	24-06-2021 14:51	77,00
3382	24-06-2021 14:51	77,00
3383	24-06-2021 14:51	77,00
3384	24-06-2021 14:51	77,00
3385	24-06-2021 14:51	77,00
3386	24-06-2021 14:51	77,00
3387	24-06-2021 14:51	77,00
3388	24-06-2021 14:51	77,00
3389	24-06-2021 14:51	77,00
3390	24-06-2021 14:51	76,00
3391	24-06-2021 14:51	76,00
3392	24-06-2021 14:52	76,00
3393	24-06-2021 14:52	76,00
3394	24-06-2021 14:52	76,00
3395	24-06-2021 14:52	76,00
3396	24-06-2021 14:52	76,00
3397	24-06-2021 14:52	76,00

3398	24-06-2021 14:52	76,00
3399	24-06-2021 14:52	76,00
3400	24-06-2021 14:52	76,00
3401	24-06-2021 14:52	76,00
3402	24-06-2021 14:52	76,00
3403	24-06-2021 14:52	77,00
3404	24-06-2021 14:52	77,00
3405	24-06-2021 14:52	77,00
3406	24-06-2021 14:52	77,00
3407	24-06-2021 14:53	77,00
3408	24-06-2021 14:53	77,00
3409	24-06-2021 14:53	77,00
3410	24-06-2021 14:53	77,00
3411	24-06-2021 14:53	77,00
3412	24-06-2021 14:53	77,00
3413	24-06-2021 14:53	77,00
3414	24-06-2021 14:53	77,00
3415	24-06-2021 14:53	77,00
3416	24-06-2021 14:53	77,00
3417	24-06-2021 14:53	77,00
3418	24-06-2021 14:53	77,00
3419	24-06-2021 14:54	77,00
3420	24-06-2021 14:54	77,00
3421	24-06-2021 14:54	77,00
3422	24-06-2021 14:54	77,00
3423	24-06-2021 14:54	77,00
3424	24-06-2021 14:54	77,00
3425	24-06-2021 14:54	77,00
3426	24-06-2021 14:54	77,00
3427	24-06-2021 14:54	77,00
3428	24-06-2021 14:54	77,00
3429	24-06-2021 14:54	77,00
3430	24-06-2021 14:54	77,00
3431	24-06-2021 14:54	77,00
3432	24-06-2021 14:54	77,00
3433	24-06-2021 14:54	77,00
3434	24-06-2021 14:54	77,00
3435	24-06-2021 14:54	77,00
3436	24-06-2021 14:55	77,00
3437	24-06-2021 14:55	77,00
3438	24-06-2021 14:55	77,00
3439	24-06-2021 14:55	77,00



3440	24-06-2021 14:55	77,00
3441	24-06-2021 14:56	77,00
3442	24-06-2021 14:56	77,00
3443	24-06-2021 14:56	77,00
3444	24-06-2021 14:56	77,00
3445	24-06-2021 14:56	77,00
3446	24-06-2021 14:56	77,00
3447	24-06-2021 14:56	77,00
3448	24-06-2021 14:56	77,00
3449	24-06-2021 14:56	77,00
3450	24-06-2021 14:56	77,00
3451	24-06-2021 14:56	77,00
3452	24-06-2021 14:56	77,00
3453	24-06-2021 14:56	77,00
3454	24-06-2021 14:56	77,00
3455	24-06-2021 14:57	77,00
3456	24-06-2021 14:57	77,00
3457	24-06-2021 14:57	77,00
3458	24-06-2021 14:57	77,00
3459	24-06-2021 14:57	77,00
3460	24-06-2021 14:57	77,00
3461	24-06-2021 14:57	77,00
3462	24-06-2021 14:57	77,00
3463	24-06-2021 14:57	77,00
3464	24-06-2021 14:57	77,00
3465	24-06-2021 14:57	77,00
3466	24-06-2021 14:57	77,00
3467	24-06-2021 14:57	77,00
3468	24-06-2021 14:57	77,00
3469	24-06-2021 14:57	77,00
3470	24-06-2021 14:58	77,00
3471	24-06-2021 14:58	77,00
3472	24-06-2021 14:58	77,00
3473	24-06-2021 14:58	77,00
3474	24-06-2021 14:58	77,00
3475	24-06-2021 14:58	77,00
3476	24-06-2021 14:58	77,00
3477	24-06-2021 14:58	76,00
3478	24-06-2021 14:58	76,00
3479	24-06-2021 14:58	76,00
3480	24-06-2021 14:58	76,00
3481	24-06-2021 14:58	76,00

3482	24-06-2021 14:59	76,00
3483	24-06-2021 14:59	76,00
3484	24-06-2021 14:59	76,00
3485	24-06-2021 14:59	76,00
3486	24-06-2021 14:59	76,00
3487	24-06-2021 14:59	76,00
3488	24-06-2021 14:59	76,00
3489	24-06-2021 14:59	76,00
3490	24-06-2021 14:59	76,00
3491	24-06-2021 14:59	76,00
3492	24-06-2021 14:59	76,00
3493	24-06-2021 14:59	76,00
3494	24-06-2021 15:00	76,00
3495	24-06-2021 15:00	76,00
3496	24-06-2021 15:00	76,00
3497	24-06-2021 15:00	76,00
3498	24-06-2021 15:00	76,00
3499	24-06-2021 15:00	76,00
3500	24-06-2021 15:00	77,00
3501	24-06-2021 15:00	77,00
3502	24-06-2021 15:00	77,00
3503	24-06-2021 15:00	77,00
3504	24-06-2021 15:00	77,00
3505	24-06-2021 15:00	77,00
3506	24-06-2021 15:00	77,00
3507	24-06-2021 15:00	77,00
3508	24-06-2021 15:01	77,00
3509	24-06-2021 15:01	77,00
3510	24-06-2021 15:01	77,00
3511	24-06-2021 15:01	77,00
3512	24-06-2021 15:01	77,00
3513	24-06-2021 15:01	77,00
3514	24-06-2021 15:01	77,00
3515	24-06-2021 15:01	77,00
3516	24-06-2021 15:01	77,00
3517	24-06-2021 15:01	77,00
3518	24-06-2021 15:01	77,00
3519	24-06-2021 15:01	77,00
3520	24-06-2021 15:01	77,00
3521	24-06-2021 15:01	77,00
3522	24-06-2021 15:01	77,00
3523	24-06-2021 15:01	77,00

3524	24-06-2021 15:02	77,00
3525	24-06-2021 15:02	77,00
3526	24-06-2021 15:02	77,00
3527	24-06-2021 15:02	77,00
3528	24-06-2021 15:02	77,00
3529	24-06-2021 15:02	77,00
3530	24-06-2021 15:02	77,00
3531	24-06-2021 15:02	77,00
3532	24-06-2021 15:02	77,00
3533	24-06-2021 15:02	77,00
3534	24-06-2021 15:02	77,00
3535	24-06-2021 15:02	77,00
3536	24-06-2021 15:02	77,00
3537	24-06-2021 15:02	77,00
3538	24-06-2021 15:02	77,00
3539	24-06-2021 15:02	77,00
3540	24-06-2021 15:02	77,00
3541	24-06-2021 15:02	77,00
3542	24-06-2021 15:03	77,00
3543	24-06-2021 15:03	77,00
3544	24-06-2021 15:03	77,00
3545	24-06-2021 15:03	77,00
3546	24-06-2021 15:03	77,00
3547	24-06-2021 15:03	77,00
3548	24-06-2021 15:03	77,00
3549	24-06-2021 15:03	77,00
3550	24-06-2021 15:04	77,00
3551	24-06-2021 15:04	77,00
3552	24-06-2021 15:04	77,00
3553	24-06-2021 15:04	77,00
3554	24-06-2021 15:04	77,00
3555	24-06-2021 15:04	77,00
3556	24-06-2021 15:04	77,00
3557	24-06-2021 15:04	77,00
3558	24-06-2021 15:04	77,00
3559	24-06-2021 15:04	77,00
3560	24-06-2021 15:04	77,00
3561	24-06-2021 15:04	77,00
3562	24-06-2021 15:04	77,00
3563	24-06-2021 15:04	77,00
3564	24-06-2021 15:04	77,00
3565	24-06-2021 15:04	77,00

3566	24-06-2021 15:04	77,00
3567	24-06-2021 15:05	77,00
3568	24-06-2021 15:05	77,00
3569	24-06-2021 15:05	77,00
3570	24-06-2021 15:05	77,00
3571	24-06-2021 15:05	77,00
3572	24-06-2021 15:05	77,00
3573	24-06-2021 15:05	77,00
3574	24-06-2021 15:05	77,00
3575	24-06-2021 15:05	77,00
3576	24-06-2021 15:05	77,00
3577	24-06-2021 15:05	77,00
3578	24-06-2021 15:05	77,00
3579	24-06-2021 15:06	77,00
3580	24-06-2021 15:06	77,00
3581	24-06-2021 15:06	77,00
3582	24-06-2021 15:06	77,00
3583	24-06-2021 15:06	77,00
3584	24-06-2021 15:06	77,00
3585	24-06-2021 15:06	77,00
3586	24-06-2021 15:06	77,00
3587	24-06-2021 15:06	77,00
3588	24-06-2021 15:06	77,00
3589	24-06-2021 15:06	77,00
3590	24-06-2021 15:06	77,00
3591	24-06-2021 15:06	77,00
3592	24-06-2021 15:06	77,00
3593	24-06-2021 15:06	77,00
3594	24-06-2021 15:06	77,00
3595	24-06-2021 15:07	77,00
3596	24-06-2021 15:07	77,00
3597	24-06-2021 15:07	77,00
3598	24-06-2021 15:07	77,00
3599	24-06-2021 15:07	77,00
3600	24-06-2021 15:07	77,00
3601	24-06-2021 15:07	77,00
3602	24-06-2021 15:07	77,00
3603	24-06-2021 15:07	77,00
3604	24-06-2021 15:07	77,00
3605	24-06-2021 15:07	77,00
3606	24-06-2021 15:07	77,00
3607	24-06-2021 15:07	77,00

3608	24-06-2021 15:07	77,00
3609	24-06-2021 15:08	77,00
3610	24-06-2021 15:08	77,00
3611	24-06-2021 15:08	76,00
3612	24-06-2021 15:08	76,00
3613	24-06-2021 15:08	76,00
3614	24-06-2021 15:08	76,00
3615	24-06-2021 15:08	76,00
3616	24-06-2021 15:08	76,00
3617	24-06-2021 15:08	76,00
3618	24-06-2021 15:08	76,00
3619	24-06-2021 15:08	76,00
3620	24-06-2021 15:08	76,00
3621	24-06-2021 15:08	76,00
3622	24-06-2021 15:08	76,00
3623	24-06-2021 15:08	76,00
3624	24-06-2021 15:08	76,00
3625	24-06-2021 15:08	76,00
3626	24-06-2021 15:08	76,00
3627	24-06-2021 15:08	76,00
3628	24-06-2021 15:08	76,00
3629	24-06-2021 15:09	76,00
3630	24-06-2021 15:09	76,00
3631	24-06-2021 15:09	76,00
3632	24-06-2021 15:09	76,00
3633	24-06-2021 15:09	76,00
3634	24-06-2021 15:09	76,00
3635	24-06-2021 15:09	76,00
3636	24-06-2021 15:09	76,00
3637	24-06-2021 15:09	76,00
3638	24-06-2021 15:09	76,00
3639	24-06-2021 15:09	76,00
3640	24-06-2021 15:09	76,00
3641	24-06-2021 15:09	76,00
3642	24-06-2021 15:09	76,00
3643	24-06-2021 15:09	76,00
3644	24-06-2021 15:09	76,00
3645	24-06-2021 15:09	76,00
3646	24-06-2021 15:09	76,00
3647	24-06-2021 15:10	76,00
3648	24-06-2021 15:10	76,00
3649	24-06-2021 15:10	76,00

3650	24-06-2021 15:10	76,00
3651	24-06-2021 15:10	76,00
3652	24-06-2021 15:10	76,00
3653	24-06-2021 15:10	76,00
3654	24-06-2021 15:10	76,00
3655	24-06-2021 15:10	76,00
3656	24-06-2021 15:10	76,00
3657	24-06-2021 15:10	76,00
3658	24-06-2021 15:10	76,00
3659	24-06-2021 15:11	76,00
3660	24-06-2021 15:11	76,00
3661	24-06-2021 15:11	76,00
3662	24-06-2021 15:11	76,00
3663	24-06-2021 15:11	76,00
3664	24-06-2021 15:11	76,00
3665	24-06-2021 15:11	76,00
3666	24-06-2021 15:11	76,00
3667	24-06-2021 15:11	76,00
3668	24-06-2021 15:11	76,00
3669	24-06-2021 15:11	76,00
3670	24-06-2021 15:11	76,00
3671	24-06-2021 15:11	76,00
3672	24-06-2021 15:12	76,00
3673	24-06-2021 15:12	76,00
3674	24-06-2021 15:12	76,00
3675	24-06-2021 15:12	76,00
3676	24-06-2021 15:12	76,00
3677	24-06-2021 15:12	76,00
3678	24-06-2021 15:12	76,00
3679	24-06-2021 15:12	76,00
3680	24-06-2021 15:12	76,00
3681	24-06-2021 15:12	77,00
3682	24-06-2021 15:12	77,00
3683	24-06-2021 15:12	77,00
3684	24-06-2021 15:13	77,00
3685	24-06-2021 15:13	77,00
3686	24-06-2021 15:13	77,00
3687	24-06-2021 15:13	77,00
3688	24-06-2021 15:13	77,00
3689	24-06-2021 15:13	77,00
3690	24-06-2021 15:13	77,00
3691	24-06-2021 15:13	77,00

3692	24-06-2021 15:13	77,00
3693	24-06-2021 15:13	77,00
3694	24-06-2021 15:13	77,00
3695	24-06-2021 15:13	77,00
3696	24-06-2021 15:13	77,00
3697	24-06-2021 15:13	77,00
3698	24-06-2021 15:13	77,00
3699	24-06-2021 15:13	77,00
3700	24-06-2021 15:13	77,00
3701	24-06-2021 15:13	77,00
3702	24-06-2021 15:13	77,00
3703	24-06-2021 15:13	77,00
3704	24-06-2021 15:14	77,00
3705	24-06-2021 15:14	77,00
3706	24-06-2021 15:14	77,00
3707	24-06-2021 15:14	77,00
3708	24-06-2021 15:14	77,00
3709	24-06-2021 15:14	77,00
3710	24-06-2021 15:14	77,00
3711	24-06-2021 15:14	77,00
3712	24-06-2021 15:15	77,00
3713	24-06-2021 15:15	77,00
3714	24-06-2021 15:15	77,00
3715	24-06-2021 15:15	77,00
3716	24-06-2021 15:15	77,00
3717	24-06-2021 15:15	77,00
3718	24-06-2021 15:15	77,00
3719	24-06-2021 15:15	77,00
3720	24-06-2021 15:15	77,00
3721	24-06-2021 15:15	77,00
3722	24-06-2021 15:15	77,00
3723	24-06-2021 15:15	77,00
3724	24-06-2021 15:15	77,00
3725	24-06-2021 15:15	77,00
3726	24-06-2021 15:15	77,00
3727	24-06-2021 15:15	77,00
3728	24-06-2021 15:15	77,00
3729	24-06-2021 15:15	77,00
3730	24-06-2021 15:15	77,00
3731	24-06-2021 15:15	77,00
3732	24-06-2021 15:15	77,00
3733	24-06-2021 15:15	77,00

3734	24-06-2021 15:15	77,00
3735	24-06-2021 15:16	77,00
3736	24-06-2021 15:16	77,00
3737	24-06-2021 15:16	77,00
3738	24-06-2021 15:16	77,00
3739	24-06-2021 15:16	77,00
3740	24-06-2021 15:16	77,00
3741	24-06-2021 15:17	77,00
3742	24-06-2021 15:17	77,00
3743	24-06-2021 15:17	77,00
3744	24-06-2021 15:17	77,00
3745	24-06-2021 15:17	77,00
3746	24-06-2021 15:17	77,00
3747	24-06-2021 15:17	77,00
3748	24-06-2021 15:17	77,00
3749	24-06-2021 15:17	77,00
3750	24-06-2021 15:17	77,00
3751	24-06-2021 15:17	77,00
3752	24-06-2021 15:17	77,00
3753	24-06-2021 15:17	77,00
3754	24-06-2021 15:17	77,00
3755	24-06-2021 15:17	77,00
3756	24-06-2021 15:17	76,00
3757	24-06-2021 15:17	76,00
3758	24-06-2021 15:17	76,00
3759	24-06-2021 15:17	76,00
3760	24-06-2021 15:18	76,00
3761	24-06-2021 15:18	76,00
3762	24-06-2021 15:18	76,00
3763	24-06-2021 15:18	76,00
3764	24-06-2021 15:18	76,00
3765	24-06-2021 15:18	76,00
3766	24-06-2021 15:18	76,00
3767	24-06-2021 15:18	76,00
3768	24-06-2021 15:18	76,00
3769	24-06-2021 15:18	76,00
3770	24-06-2021 15:18	77,00
3771	24-06-2021 15:18	77,00
3772	24-06-2021 15:18	77,00
3773	24-06-2021 15:18	77,00
3774	24-06-2021 15:18	77,00
3775	24-06-2021 15:18	77,00

3776	24-06-2021 15:18	77,00
3777	24-06-2021 15:18	77,00
3778	24-06-2021 15:18	77,00
3779	24-06-2021 15:18	77,00
3780	24-06-2021 15:18	77,00
3781	24-06-2021 15:18	77,00
3782	24-06-2021 15:18	77,00
3783	24-06-2021 15:18	77,00
3784	24-06-2021 15:19	77,00
3785	24-06-2021 15:19	77,00
3786	24-06-2021 15:19	77,00
3787	24-06-2021 15:19	77,00
3788	24-06-2021 15:20	77,00
3789	24-06-2021 15:20	77,00
3790	24-06-2021 15:20	77,00
3791	24-06-2021 15:20	77,00
3792	24-06-2021 15:20	77,00
3793	24-06-2021 15:20	77,00
3794	24-06-2021 15:20	77,00
3795	24-06-2021 15:20	77,00
3796	24-06-2021 15:20	77,00
3797	24-06-2021 15:20	77,00
3798	24-06-2021 15:20	77,00
3799	24-06-2021 15:20	77,00
3800	24-06-2021 15:20	77,00
3801	24-06-2021 15:20	77,00
3802	24-06-2021 15:20	77,00
3803	24-06-2021 15:20	77,00
3804	24-06-2021 15:20	77,00
3805	24-06-2021 15:20	77,00
3806	24-06-2021 15:20	77,00
3807	24-06-2021 15:20	77,00
3808	24-06-2021 15:20	77,00
3809	24-06-2021 15:21	77,00
3810	24-06-2021 15:21	77,00
3811	24-06-2021 15:21	77,00
3812	24-06-2021 15:21	77,00
3813	24-06-2021 15:21	77,00
3814	24-06-2021 15:21	77,00
3815	24-06-2021 15:21	77,00
3816	24-06-2021 15:21	77,00
3817	24-06-2021 15:21	77,00

3818	24-06-2021 15:21	77,00
3819	24-06-2021 15:21	77,00
3820	24-06-2021 15:21	77,00
3821	24-06-2021 15:21	77,00
3822	24-06-2021 15:21	77,00
3823	24-06-2021 15:21	77,00
3824	24-06-2021 15:21	77,00
3825	24-06-2021 15:22	77,00
3826	24-06-2021 15:22	77,00
3827	24-06-2021 15:22	77,00
3828	24-06-2021 15:22	77,00
3829	24-06-2021 15:22	77,00
3830	24-06-2021 15:22	77,00
3831	24-06-2021 15:22	77,00
3832	24-06-2021 15:22	77,00
3833	24-06-2021 15:22	77,00
3834	24-06-2021 15:22	77,00
3835	24-06-2021 15:22	77,00
3836	24-06-2021 15:22	77,00
3837	24-06-2021 15:22	77,00
3838	24-06-2021 15:22	77,00
3839	24-06-2021 15:22	76,00
3840	24-06-2021 15:22	76,00
3841	24-06-2021 15:22	76,00
3842	24-06-2021 15:22	76,00
3843	24-06-2021 15:22	76,00
3844	24-06-2021 15:22	76,00
3845	24-06-2021 15:22	76,00
3846	24-06-2021 15:22	76,00
3847	24-06-2021 15:23	76,00
3848	24-06-2021 15:23	76,00
3849	24-06-2021 15:23	76,00
3850	24-06-2021 15:23	76,00
3851	24-06-2021 15:23	76,00
3852	24-06-2021 15:23	76,00
3853	24-06-2021 15:23	76,00
3854	24-06-2021 15:23	76,00
3855	24-06-2021 15:23	76,00
3856	24-06-2021 15:23	76,00
3857	24-06-2021 15:23	76,00
3858	24-06-2021 15:23	76,00
3859	24-06-2021 15:23	76,00

3860	24-06-2021 15:23	76,00
3861	24-06-2021 15:23	76,00
3862	24-06-2021 15:23	76,00
3863	24-06-2021 15:24	76,00
3864	24-06-2021 15:24	76,00
3865	24-06-2021 15:24	76,00
3866	24-06-2021 15:24	76,00
3867	24-06-2021 15:24	76,00
3868	24-06-2021 15:24	76,00
3869	24-06-2021 15:24	76,00
3870	24-06-2021 15:24	76,00
3871	24-06-2021 15:24	76,00
3872	24-06-2021 15:24	76,00
3873	24-06-2021 15:24	76,00
3874	24-06-2021 15:24	76,00
3875	24-06-2021 15:24	76,00
3876	24-06-2021 15:25	76,00
3877	24-06-2021 15:25	76,00
3878	24-06-2021 15:26	76,00
3879	24-06-2021 15:26	76,00
3880	24-06-2021 15:26	76,00
3881	24-06-2021 15:26	76,00
3882	24-06-2021 15:26	76,00
3883	24-06-2021 15:26	76,00
3884	24-06-2021 15:26	76,00
3885	24-06-2021 15:26	76,00
3886	24-06-2021 15:26	76,00
3887	24-06-2021 15:27	76,00
3888	24-06-2021 15:27	76,00
3889	24-06-2021 15:27	76,00
3890	24-06-2021 15:27	76,00
3891	24-06-2021 15:27	76,00
3892	24-06-2021 15:27	76,00
3893	24-06-2021 15:27	76,00
3894	24-06-2021 15:27	76,00
3895	24-06-2021 15:27	76,00
3896	24-06-2021 15:27	75,00
3897	24-06-2021 15:27	75,00
3898	24-06-2021 15:28	75,00
3899	24-06-2021 15:28	75,00
3900	24-06-2021 15:28	75,00
3901	24-06-2021 15:28	75,00

3902	24-06-2021 15:29	76,00
3903	24-06-2021 15:29	76,00
3904	24-06-2021 15:29	76,00
3905	24-06-2021 15:29	76,00
3906	24-06-2021 15:29	76,00
3907	24-06-2021 15:29	76,00
3908	24-06-2021 15:29	76,00
3909	24-06-2021 15:29	76,00
3910	24-06-2021 15:29	76,00
3911	24-06-2021 15:29	76,00
3912	24-06-2021 15:29	76,00
3913	24-06-2021 15:29	76,00
3914	24-06-2021 15:29	76,00
3915	24-06-2021 15:29	76,00
3916	24-06-2021 15:29	76,00
3917	24-06-2021 15:29	76,00
3918	24-06-2021 15:29	76,00
3919	24-06-2021 15:29	76,00
3920	24-06-2021 15:29	76,00
3921	24-06-2021 15:29	76,00
3922	24-06-2021 15:29	76,00
3923	24-06-2021 15:29	76,00
3924	24-06-2021 15:30	76,00
3925	24-06-2021 15:30	76,00
3926	24-06-2021 15:30	76,00
3927	24-06-2021 15:30	76,00
3928	24-06-2021 15:30	76,00
3929	24-06-2021 15:30	76,00
3930	24-06-2021 15:30	76,00
3931	24-06-2021 15:30	76,00
3932	24-06-2021 15:30	76,00
3933	24-06-2021 15:30	76,00
3934	24-06-2021 15:30	76,00
3935	24-06-2021 15:30	76,00
3936	24-06-2021 15:30	76,00
3937	24-06-2021 15:30	76,00
3938	24-06-2021 15:30	76,00
3939	24-06-2021 15:30	76,00
3940	24-06-2021 15:30	76,00
3941	24-06-2021 15:30	76,00
3942	24-06-2021 15:30	76,00
3943	24-06-2021 15:30	76,00

3944	24-06-2021 15:30	76,00
3945	24-06-2021 15:30	76,00
3946	24-06-2021 15:30	76,00
3947	24-06-2021 15:30	76,00
3948	24-06-2021 15:30	76,00
3949	24-06-2021 15:30	76,00

F.2 REGISTRO DE MEDICIONES DE PRESIÓN  
ATMOSFÉRICA

Promedio		1.024,84
Ítem	Fecha y Hora	Presión atmosférica [mbar]
1	2021-06-24 10:30:01	1.026,28
2	2021-06-24 10:30:03	1.026,28
3	2021-06-24 10:30:05	1.026,28
4	2021-06-24 10:30:11	1.026,21
5	2021-06-24 10:30:13	1.026,21
6	2021-06-24 10:30:15	1.026,21
7	2021-06-24 10:30:25	1.026,21
8	2021-06-24 10:30:27	1.026,21
9	2021-06-24 10:30:29	1.026,21
10	2021-06-24 10:30:52	1.026,21
11	2021-06-24 10:30:54	1.026,21
12	2021-06-24 10:30:56	1.026,21
13	2021-06-24 10:30:58	1.026,21
14	2021-06-24 10:31:02	1.026,21
15	2021-06-24 10:31:04	1.026,21
16	2021-06-24 10:31:06	1.026,21
17	2021-06-24 10:31:08	1.026,25
18	2021-06-24 10:31:18	1.026,25
19	2021-06-24 10:31:25	1.026,25
20	2021-06-24 10:31:27	1.026,25
21	2021-06-24 10:31:29	1.026,25
22	2021-06-24 10:31:31	1.026,25
23	2021-06-24 10:31:33	1.026,25
24	2021-06-24 10:31:35	1.026,25
25	2021-06-24 10:31:37	1.026,25
26	2021-06-24 10:31:41	1.026,25
27	2021-06-24 10:31:43	1.026,25
28	2021-06-24 10:32:14	1.026,21
29	2021-06-24 10:32:16	1.026,21
30	2021-06-24 10:32:18	1.026,21
31	2021-06-24 10:32:20	1.026,21
32	2021-06-24 10:32:22	1.026,21
33	2021-06-24 10:32:24	1.026,21
34	2021-06-24 10:32:26	1.026,21
35	2021-06-24 10:32:32	1.026,21

36	2021-06-24 10:32:44	1.026,21
37	2021-06-24 10:32:46	1.026,21
38	2021-06-24 10:32:48	1.026,21
39	2021-06-24 10:32:55	1.026,21
40	2021-06-24 10:32:57	1.026,21
41	2021-06-24 10:32:59	1.026,21
42	2021-06-24 10:33:01	1.026,21
43	2021-06-24 10:33:07	1.026,21
44	2021-06-24 10:33:11	1.026,04
45	2021-06-24 10:33:13	1.026,04
46	2021-06-24 10:33:15	1.026,04
47	2021-06-24 10:33:17	1.026,04
48	2021-06-24 10:33:19	1.026,04
49	2021-06-24 10:33:21	1.026,04
50	2021-06-24 10:33:23	1.026,04
51	2021-06-24 10:33:27	1.026,04
52	2021-06-24 10:33:29	1.026,04
53	2021-06-24 10:33:31	1.026,04
54	2021-06-24 10:33:33	1.026,04
55	2021-06-24 10:33:44	1.026,04
56	2021-06-24 10:33:56	1.026,04
57	2021-06-24 10:33:58	1.026,04
58	2021-06-24 10:34:04	1.026,04
59	2021-06-24 10:34:06	1.026,04
60	2021-06-24 10:34:08	1.026,04
61	2021-06-24 10:34:10	1.026,04
62	2021-06-24 10:34:12	1.026,04
63	2021-06-24 10:34:35	1.026,04
64	2021-06-24 10:34:37	1.026,04
65	2021-06-24 10:34:39	1.026,04
66	2021-06-24 10:34:41	1.026,04
67	2021-06-24 10:34:43	1.026,04
68	2021-06-24 10:34:45	1.026,04
69	2021-06-24 10:34:47	1.026,04
70	2021-06-24 10:35:28	1.026,04
71	2021-06-24 10:35:30	1.026,04
72	2021-06-24 10:35:32	1.026,04
73	2021-06-24 10:35:34	1.026,04
74	2021-06-24 10:36:03	1.026,04
75	2021-06-24 10:36:13	1.026,11
76	2021-06-24 10:36:15	1.026,11
77	2021-06-24 10:36:17	1.026,11



78	2021-06-24 10:36:19	1.026,11	120	2021-06-24 10:39:48	1.026,14
79	2021-06-24 10:36:21	1.026,11	121	2021-06-24 10:39:50	1.026,14
80	2021-06-24 10:36:27	1.026,11	122	2021-06-24 10:39:52	1.026,14
81	2021-06-24 10:36:29	1.026,11	123	2021-06-24 10:39:54	1.026,14
82	2021-06-24 10:37:02	1.026,11	124	2021-06-24 10:40:08	1.026,14
83	2021-06-24 10:37:06	1.026,11	125	2021-06-24 10:40:10	1.026,14
84	2021-06-24 10:37:12	1.026,11	126	2021-06-24 10:40:12	1.026,14
85	2021-06-24 10:37:16	1.026,11	127	2021-06-24 10:40:14	1.026,14
86	2021-06-24 10:37:18	1.026,11	128	2021-06-24 10:40:18	1.026,14
87	2021-06-24 10:37:25	1.026,11	129	2021-06-24 10:40:25	1.026,14
88	2021-06-24 10:37:27	1.026,11	130	2021-06-24 10:40:27	1.026,14
89	2021-06-24 10:37:29	1.026,11	131	2021-06-24 10:40:35	1.026,14
90	2021-06-24 10:37:33	1.026,11	132	2021-06-24 10:40:43	1.026,14
91	2021-06-24 10:37:45	1.026,11	133	2021-06-24 10:40:53	1.026,14
92	2021-06-24 10:37:47	1.026,11	134	2021-06-24 10:40:57	1.026,14
93	2021-06-24 10:37:49	1.026,11	135	2021-06-24 10:40:59	1.026,14
94	2021-06-24 10:37:51	1.026,11	136	2021-06-24 10:41:03	1.026,14
95	2021-06-24 10:37:53	1.026,11	137	2021-06-24 10:41:10	1.026,11
96	2021-06-24 10:37:55	1.026,11	138	2021-06-24 10:41:12	1.026,11
97	2021-06-24 10:38:10	1.026,11	139	2021-06-24 10:41:14	1.026,11
98	2021-06-24 10:38:12	1.026,11	140	2021-06-24 10:41:16	1.026,11
99	2021-06-24 10:38:14	1.026,11	141	2021-06-24 10:41:18	1.026,11
100	2021-06-24 10:38:18	1.026,11	142	2021-06-24 10:41:20	1.026,11
101	2021-06-24 10:38:44	1.026,11	143	2021-06-24 10:41:22	1.026,11
102	2021-06-24 10:39:03	1.026,11	144	2021-06-24 10:41:24	1.026,11
103	2021-06-24 10:39:05	1.026,11	145	2021-06-24 10:41:26	1.026,11
104	2021-06-24 10:39:07	1.026,14	146	2021-06-24 10:41:28	1.026,11
105	2021-06-24 10:39:09	1.026,14	147	2021-06-24 10:41:30	1.026,11
106	2021-06-24 10:39:13	1.026,14	148	2021-06-24 10:41:38	1.026,11
107	2021-06-24 10:39:15	1.026,14	149	2021-06-24 10:41:40	1.026,11
108	2021-06-24 10:39:19	1.026,14	150	2021-06-24 10:41:42	1.026,11
109	2021-06-24 10:39:21	1.026,14	151	2021-06-24 10:41:44	1.026,11
110	2021-06-24 10:39:23	1.026,14	152	2021-06-24 10:41:48	1.026,11
111	2021-06-24 10:39:25	1.026,14	153	2021-06-24 10:42:17	1.026,08
112	2021-06-24 10:39:27	1.026,14	154	2021-06-24 10:42:19	1.026,08
113	2021-06-24 10:39:29	1.026,14	155	2021-06-24 10:42:21	1.026,08
114	2021-06-24 10:39:31	1.026,14	156	2021-06-24 10:42:23	1.026,08
115	2021-06-24 10:39:34	1.026,14	157	2021-06-24 10:42:25	1.026,08
116	2021-06-24 10:39:40	1.026,14	158	2021-06-24 10:42:27	1.026,08
117	2021-06-24 10:39:42	1.026,14	159	2021-06-24 10:42:29	1.026,08
118	2021-06-24 10:39:44	1.026,14	160	2021-06-24 10:42:31	1.026,08
119	2021-06-24 10:39:46	1.026,14	161	2021-06-24 10:42:50	1.026,08

162	2021-06-24 10:42:52	1.026,08	204	2021-06-24 10:46:12	1.026,08
163	2021-06-24 10:42:54	1.026,08	205	2021-06-24 10:46:14	1.026,08
164	2021-06-24 10:42:56	1.026,08	206	2021-06-24 10:46:16	1.026,08
165	2021-06-24 10:42:58	1.026,08	207	2021-06-24 10:46:25	1.026,08
166	2021-06-24 10:43:00	1.026,08	208	2021-06-24 10:46:27	1.026,08
167	2021-06-24 10:43:02	1.026,08	209	2021-06-24 10:46:29	1.026,08
168	2021-06-24 10:43:04	1.026,08	210	2021-06-24 10:46:33	1.026,08
169	2021-06-24 10:43:06	1.026,08	211	2021-06-24 10:46:35	1.026,08
170	2021-06-24 10:43:25	1.026,14	212	2021-06-24 10:46:37	1.026,08
171	2021-06-24 10:43:27	1.026,14	213	2021-06-24 10:46:39	1.026,08
172	2021-06-24 10:43:29	1.026,14	214	2021-06-24 10:46:41	1.026,08
173	2021-06-24 10:43:31	1.026,14	215	2021-06-24 10:46:43	1.026,08
174	2021-06-24 10:43:33	1.026,14	216	2021-06-24 10:46:45	1.026,08
175	2021-06-24 10:43:35	1.026,14	217	2021-06-24 10:46:47	1.026,08
176	2021-06-24 10:43:37	1.026,14	218	2021-06-24 10:46:55	1.026,08
177	2021-06-24 10:43:45	1.026,14	219	2021-06-24 10:46:59	1.026,08
178	2021-06-24 10:43:47	1.026,14	220	2021-06-24 10:47:10	1.026,08
179	2021-06-24 10:43:49	1.026,14	221	2021-06-24 10:47:12	1.026,08
180	2021-06-24 10:43:53	1.026,14	222	2021-06-24 10:47:14	1.026,08
181	2021-06-24 10:43:55	1.026,14	223	2021-06-24 10:47:16	1.026,08
182	2021-06-24 10:43:57	1.026,14	224	2021-06-24 10:47:24	1.026,08
183	2021-06-24 10:43:59	1.026,14	225	2021-06-24 10:47:26	1.026,08
184	2021-06-24 10:44:01	1.026,14	226	2021-06-24 10:47:34	1.026,08
185	2021-06-24 10:44:03	1.026,14	227	2021-06-24 10:47:36	1.026,08
186	2021-06-24 10:44:14	1.026,08	228	2021-06-24 10:47:38	1.026,08
187	2021-06-24 10:44:29	1.026,08	229	2021-06-24 10:47:40	1.026,08
188	2021-06-24 10:44:31	1.026,08	230	2021-06-24 10:47:42	1.026,08
189	2021-06-24 10:44:32	1.026,08	231	2021-06-24 10:47:44	1.026,08
190	2021-06-24 10:44:35	1.026,08	232	2021-06-24 10:48:07	1.026,11
191	2021-06-24 10:44:37	1.026,08	233	2021-06-24 10:48:09	1.026,11
192	2021-06-24 10:44:39	1.026,08	234	2021-06-24 10:48:11	1.026,11
193	2021-06-24 10:44:41	1.026,08	235	2021-06-24 10:48:13	1.026,11
194	2021-06-24 10:44:43	1.026,08	236	2021-06-24 10:48:21	1.026,11
195	2021-06-24 10:44:55	1.026,08	237	2021-06-24 10:48:23	1.026,11
196	2021-06-24 10:44:57	1.026,08	238	2021-06-24 10:48:29	1.026,11
197	2021-06-24 10:44:59	1.026,08	239	2021-06-24 10:48:31	1.026,11
198	2021-06-24 10:45:01	1.026,08	240	2021-06-24 10:48:33	1.026,11
199	2021-06-24 10:45:09	1.026,04	241	2021-06-24 10:49:03	1.026,11
200	2021-06-24 10:45:44	1.026,04	242	2021-06-24 10:49:05	1.026,11
201	2021-06-24 10:45:54	1.026,04	243	2021-06-24 10:49:15	1.026,14
202	2021-06-24 10:46:08	1.026,08	244	2021-06-24 10:49:25	1.026,14
203	2021-06-24 10:46:10	1.026,08	245	2021-06-24 10:49:27	1.026,14

246	2021-06-24 10:49:29	1.026,14	288	2021-06-24 10:52:25	1.026,01
247	2021-06-24 10:49:31	1.026,14	289	2021-06-24 10:52:27	1.026,01
248	2021-06-24 10:49:33	1.026,14	290	2021-06-24 10:52:29	1.026,01
249	2021-06-24 10:49:35	1.026,14	291	2021-06-24 10:52:31	1.026,01
250	2021-06-24 10:49:37	1.026,14	292	2021-06-24 10:52:33	1.026,01
251	2021-06-24 10:49:39	1.026,14	293	2021-06-24 10:52:37	1.026,01
252	2021-06-24 10:50:10	1.026,14	294	2021-06-24 10:52:39	1.026,01
253	2021-06-24 10:50:12	1.026,14	295	2021-06-24 10:52:41	1.026,01
254	2021-06-24 10:50:14	1.026,14	296	2021-06-24 10:52:43	1.026,01
255	2021-06-24 10:50:16	1.026,14	297	2021-06-24 10:52:45	1.026,01
256	2021-06-24 10:50:18	1.026,14	298	2021-06-24 10:53:11	1.025,87
257	2021-06-24 10:50:20	1.026,14	299	2021-06-24 10:53:13	1.025,87
258	2021-06-24 10:50:22	1.026,14	300	2021-06-24 10:53:15	1.025,87
259	2021-06-24 10:50:26	1.026,14	301	2021-06-24 10:53:17	1.025,87
260	2021-06-24 10:50:28	1.026,14	302	2021-06-24 10:53:19	1.025,87
261	2021-06-24 10:50:30	1.026,14	303	2021-06-24 10:53:21	1.025,87
262	2021-06-24 10:50:32	1.026,14	304	2021-06-24 10:53:23	1.025,87
263	2021-06-24 10:50:38	1.026,14	305	2021-06-24 10:53:25	1.025,87
264	2021-06-24 10:50:40	1.026,14	306	2021-06-24 10:53:27	1.025,87
265	2021-06-24 10:50:44	1.026,14	307	2021-06-24 10:53:29	1.025,87
266	2021-06-24 10:50:46	1.026,14	308	2021-06-24 10:53:31	1.025,87
267	2021-06-24 10:50:48	1.026,14	309	2021-06-24 10:53:33	1.025,87
268	2021-06-24 10:51:05	1.026,14	310	2021-06-24 10:53:35	1.025,87
269	2021-06-24 10:51:07	1.026,14	311	2021-06-24 10:53:37	1.025,87
270	2021-06-24 10:51:09	1.026,11	312	2021-06-24 10:53:39	1.025,87
271	2021-06-24 10:51:11	1.026,11	313	2021-06-24 10:53:41	1.025,87
272	2021-06-24 10:51:13	1.026,11	314	2021-06-24 10:53:43	1.025,87
273	2021-06-24 10:51:15	1.026,11	315	2021-06-24 10:53:45	1.025,87
274	2021-06-24 10:51:17	1.026,11	316	2021-06-24 10:53:47	1.025,87
275	2021-06-24 10:51:19	1.026,11	317	2021-06-24 10:53:49	1.025,87
276	2021-06-24 10:51:23	1.026,11	318	2021-06-24 10:53:56	1.025,87
277	2021-06-24 10:51:25	1.026,11	319	2021-06-24 10:53:58	1.025,87
278	2021-06-24 10:51:27	1.026,11	320	2021-06-24 10:54:00	1.025,87
279	2021-06-24 10:51:29	1.026,11	321	2021-06-24 10:54:02	1.025,87
280	2021-06-24 10:51:31	1.026,11	322	2021-06-24 10:54:04	1.025,87
281	2021-06-24 10:51:52	1.026,11	323	2021-06-24 10:54:06	1.025,87
282	2021-06-24 10:51:54	1.026,11	324	2021-06-24 10:54:24	1.026,01
283	2021-06-24 10:51:56	1.026,11	325	2021-06-24 10:54:30	1.026,01
284	2021-06-24 10:51:58	1.026,11	326	2021-06-24 10:54:32	1.026,01
285	2021-06-24 10:52:00	1.026,11	327	2021-06-24 10:54:34	1.026,01
286	2021-06-24 10:52:02	1.026,11	328	2021-06-24 10:54:40	1.026,01
287	2021-06-24 10:52:06	1.026,11	329	2021-06-24 10:54:42	1.026,01

330	2021-06-24 10:54:50	1.026,01	372	2021-06-24 10:57:33	1.025,87
331	2021-06-24 10:54:52	1.026,01	373	2021-06-24 10:57:40	1.025,87
332	2021-06-24 10:54:54	1.026,01	374	2021-06-24 10:57:42	1.025,87
333	2021-06-24 10:54:56	1.026,01	375	2021-06-24 10:57:44	1.025,87
334	2021-06-24 10:54:58	1.026,01	376	2021-06-24 10:57:46	1.025,87
335	2021-06-24 10:55:06	1.026,01	377	2021-06-24 10:57:48	1.025,87
336	2021-06-24 10:55:08	1.025,91	378	2021-06-24 10:57:52	1.025,87
337	2021-06-24 10:55:12	1.025,91	379	2021-06-24 10:58:04	1.025,87
338	2021-06-24 10:55:14	1.025,91	380	2021-06-24 10:58:06	1.025,87
339	2021-06-24 10:55:16	1.025,91	381	2021-06-24 10:58:08	1.025,81
340	2021-06-24 10:55:18	1.025,91	382	2021-06-24 10:58:10	1.025,81
341	2021-06-24 10:55:30	1.025,91	383	2021-06-24 10:58:26	1.025,81
342	2021-06-24 10:55:32	1.025,91	384	2021-06-24 10:58:28	1.025,81
343	2021-06-24 10:55:40	1.025,91	385	2021-06-24 10:58:42	1.025,81
344	2021-06-24 10:55:42	1.025,91	386	2021-06-24 10:58:44	1.025,81
345	2021-06-24 10:55:58	1.025,91	387	2021-06-24 10:58:46	1.025,81
346	2021-06-24 10:56:00	1.025,91	388	2021-06-24 10:58:56	1.025,81
347	2021-06-24 10:56:02	1.025,91	389	2021-06-24 10:58:58	1.025,81
348	2021-06-24 10:56:10	1.025,87	390	2021-06-24 10:59:00	1.025,81
349	2021-06-24 10:56:12	1.025,87	391	2021-06-24 10:59:02	1.025,81
350	2021-06-24 10:56:14	1.025,87	392	2021-06-24 10:59:04	1.025,81
351	2021-06-24 10:56:16	1.025,87	393	2021-06-24 10:59:14	1.025,84
352	2021-06-24 10:56:18	1.025,87	394	2021-06-24 10:59:22	1.025,84
353	2021-06-24 10:56:20	1.025,87	395	2021-06-24 10:59:26	1.025,84
354	2021-06-24 10:56:22	1.025,87	396	2021-06-24 10:59:28	1.025,84
355	2021-06-24 10:56:28	1.025,87	397	2021-06-24 10:59:30	1.025,84
356	2021-06-24 10:56:30	1.025,87	398	2021-06-24 10:59:32	1.025,84
357	2021-06-24 10:56:32	1.025,87	399	2021-06-24 10:59:34	1.025,84
358	2021-06-24 10:56:34	1.025,87	400	2021-06-24 10:59:36	1.025,84
359	2021-06-24 10:56:36	1.025,87	401	2021-06-24 10:59:38	1.025,84
360	2021-06-24 10:56:38	1.025,87	402	2021-06-24 10:59:40	1.025,84
361	2021-06-24 10:56:46	1.025,87	403	2021-06-24 10:59:44	1.025,84
362	2021-06-24 10:56:48	1.025,87	404	2021-06-24 10:59:46	1.025,84
363	2021-06-24 10:56:55	1.025,87	405	2021-06-24 10:59:48	1.025,84
364	2021-06-24 10:56:57	1.025,87	406	2021-06-24 10:59:55	1.025,84
365	2021-06-24 10:56:59	1.025,87	407	2021-06-24 10:59:57	1.025,84
366	2021-06-24 10:57:07	1.025,87	408	2021-06-24 10:59:59	1.025,84
367	2021-06-24 10:57:11	1.025,87	409	2021-06-24 11:00:01	1.025,84
368	2021-06-24 10:57:13	1.025,87	410	2021-06-24 11:00:03	1.025,84
369	2021-06-24 10:57:15	1.025,87	411	2021-06-24 11:00:05	1.025,84
370	2021-06-24 10:57:19	1.025,87	412	2021-06-24 11:00:07	1.025,84
371	2021-06-24 10:57:25	1.025,87	413	2021-06-24 11:00:11	1.025,87

414	2021-06-24 11:00:27	1.025,87	456	2021-06-24 11:02:18	1.025,84
415	2021-06-24 11:00:29	1.025,87	457	2021-06-24 11:02:20	1.025,84
416	2021-06-24 11:00:31	1.025,87	458	2021-06-24 11:02:22	1.025,84
417	2021-06-24 11:00:33	1.025,87	459	2021-06-24 11:02:24	1.025,84
418	2021-06-24 11:00:41	1.025,87	460	2021-06-24 11:02:26	1.025,84
419	2021-06-24 11:00:43	1.025,87	461	2021-06-24 11:02:28	1.025,84
420	2021-06-24 11:00:45	1.025,87	462	2021-06-24 11:02:30	1.025,84
421	2021-06-24 11:00:47	1.025,87	463	2021-06-24 11:02:32	1.025,84
422	2021-06-24 11:00:49	1.025,87	464	2021-06-24 11:02:34	1.025,84
423	2021-06-24 11:00:51	1.025,87	465	2021-06-24 11:02:36	1.025,84
424	2021-06-24 11:00:53	1.025,87	466	2021-06-24 11:03:50	1.025,81
425	2021-06-24 11:00:55	1.025,87	467	2021-06-24 11:04:04	1.025,81
426	2021-06-24 11:00:57	1.025,87	468	2021-06-24 11:04:06	1.025,81
427	2021-06-24 11:00:59	1.025,87	469	2021-06-24 11:04:08	1.025,87
428	2021-06-24 11:01:01	1.025,87	470	2021-06-24 11:04:10	1.025,87
429	2021-06-24 11:01:03	1.025,87	471	2021-06-24 11:04:12	1.025,87
430	2021-06-24 11:01:05	1.025,87	472	2021-06-24 11:04:14	1.025,87
431	2021-06-24 11:01:07	1.025,87	473	2021-06-24 11:04:16	1.025,87
432	2021-06-24 11:01:09	1.025,87	474	2021-06-24 11:04:18	1.025,87
433	2021-06-24 11:01:11	1.025,87	475	2021-06-24 11:04:25	1.025,87
434	2021-06-24 11:01:13	1.025,87	476	2021-06-24 11:04:27	1.025,87
435	2021-06-24 11:01:15	1.025,87	477	2021-06-24 11:04:29	1.025,87
436	2021-06-24 11:01:25	1.025,87	478	2021-06-24 11:04:31	1.025,87
437	2021-06-24 11:01:27	1.025,87	479	2021-06-24 11:04:33	1.025,87
438	2021-06-24 11:01:29	1.025,87	480	2021-06-24 11:04:35	1.025,87
439	2021-06-24 11:01:31	1.025,87	481	2021-06-24 11:04:37	1.025,87
440	2021-06-24 11:01:33	1.025,87	482	2021-06-24 11:04:39	1.025,87
441	2021-06-24 11:01:35	1.025,87	483	2021-06-24 11:04:41	1.025,87
442	2021-06-24 11:01:37	1.025,87	484	2021-06-24 11:04:43	1.025,87
443	2021-06-24 11:01:39	1.025,87	485	2021-06-24 11:04:45	1.025,87
444	2021-06-24 11:01:43	1.025,87	486	2021-06-24 11:04:47	1.025,87
445	2021-06-24 11:01:45	1.025,87	487	2021-06-24 11:04:49	1.025,87
446	2021-06-24 11:01:47	1.025,87	488	2021-06-24 11:04:51	1.025,87
447	2021-06-24 11:01:49	1.025,87	489	2021-06-24 11:04:53	1.025,87
448	2021-06-24 11:01:51	1.025,87	490	2021-06-24 11:04:55	1.025,87
449	2021-06-24 11:01:53	1.025,87	491	2021-06-24 11:04:57	1.025,87
450	2021-06-24 11:01:55	1.025,87	492	2021-06-24 11:04:59	1.025,87
451	2021-06-24 11:01:57	1.025,87	493	2021-06-24 11:05:01	1.025,87
452	2021-06-24 11:01:59	1.025,87	494	2021-06-24 11:05:03	1.025,87
453	2021-06-24 11:02:01	1.025,87	495	2021-06-24 11:05:36	1.025,91
454	2021-06-24 11:02:03	1.025,87	496	2021-06-24 11:05:38	1.025,91
455	2021-06-24 11:02:16	1.025,84	497	2021-06-24 11:05:40	1.025,91

498	2021-06-24 11:05:42	1.025,91	540	2021-06-24 11:09:52	1.025,87
499	2021-06-24 11:06:02	1.025,91	541	2021-06-24 11:10:00	1.025,87
500	2021-06-24 11:06:06	1.025,91	542	2021-06-24 11:10:02	1.025,87
501	2021-06-24 11:06:12	1.025,91	543	2021-06-24 11:10:04	1.025,87
502	2021-06-24 11:06:16	1.025,91	544	2021-06-24 11:10:06	1.025,87
503	2021-06-24 11:06:18	1.025,91	545	2021-06-24 11:10:36	1.025,84
504	2021-06-24 11:06:20	1.025,91	546	2021-06-24 11:10:38	1.025,84
505	2021-06-24 11:06:22	1.025,91	547	2021-06-24 11:10:40	1.025,84
506	2021-06-24 11:06:24	1.025,91	548	2021-06-24 11:11:55	1.025,81
507	2021-06-24 11:06:26	1.025,91	549	2021-06-24 11:11:57	1.025,81
508	2021-06-24 11:06:28	1.025,91	550	2021-06-24 11:11:59	1.025,81
509	2021-06-24 11:07:31	1.025,91	551	2021-06-24 11:12:01	1.025,81
510	2021-06-24 11:07:33	1.025,91	552	2021-06-24 11:12:03	1.025,81
511	2021-06-24 11:07:35	1.025,91	553	2021-06-24 11:12:19	1.025,87
512	2021-06-24 11:07:37	1.025,91	554	2021-06-24 11:12:23	1.025,87
513	2021-06-24 11:07:49	1.025,91	555	2021-06-24 11:12:25	1.025,87
514	2021-06-24 11:07:51	1.025,91	556	2021-06-24 11:12:27	1.025,87
515	2021-06-24 11:07:53	1.025,91	557	2021-06-24 11:12:29	1.025,87
516	2021-06-24 11:07:55	1.025,91	558	2021-06-24 11:12:31	1.025,87
517	2021-06-24 11:07:57	1.025,91	559	2021-06-24 11:12:33	1.025,87
518	2021-06-24 11:07:59	1.025,91	560	2021-06-24 11:12:40	1.025,87
519	2021-06-24 11:08:01	1.025,91	561	2021-06-24 11:12:42	1.025,87
520	2021-06-24 11:08:03	1.025,91	562	2021-06-24 11:12:44	1.025,87
521	2021-06-24 11:08:15	1.025,81	563	2021-06-24 11:12:52	1.025,87
522	2021-06-24 11:08:21	1.025,81	564	2021-06-24 11:12:56	1.025,87
523	2021-06-24 11:08:25	1.025,81	565	2021-06-24 11:12:58	1.025,87
524	2021-06-24 11:08:27	1.025,81	566	2021-06-24 11:13:00	1.025,87
525	2021-06-24 11:08:29	1.025,81	567	2021-06-24 11:13:02	1.025,87
526	2021-06-24 11:08:31	1.025,81	568	2021-06-24 11:13:04	1.025,87
527	2021-06-24 11:08:35	1.025,81	569	2021-06-24 11:13:06	1.025,87
528	2021-06-24 11:08:37	1.025,81	570	2021-06-24 11:13:12	1.025,87
529	2021-06-24 11:08:55	1.025,81	571	2021-06-24 11:13:16	1.025,87
530	2021-06-24 11:08:57	1.025,81	572	2021-06-24 11:13:18	1.025,87
531	2021-06-24 11:08:59	1.025,81	573	2021-06-24 11:13:25	1.025,87
532	2021-06-24 11:09:07	1.025,81	574	2021-06-24 11:13:27	1.025,87
533	2021-06-24 11:09:09	1.025,87	575	2021-06-24 11:13:29	1.025,87
534	2021-06-24 11:09:15	1.025,87	576	2021-06-24 11:13:31	1.025,87
535	2021-06-24 11:09:19	1.025,87	577	2021-06-24 11:13:33	1.025,87
536	2021-06-24 11:09:21	1.025,87	578	2021-06-24 11:13:35	1.025,87
537	2021-06-24 11:09:23	1.025,87	579	2021-06-24 11:13:37	1.025,87
538	2021-06-24 11:09:25	1.025,87	580	2021-06-24 11:13:39	1.025,87
539	2021-06-24 11:09:44	1.025,87	581	2021-06-24 11:13:41	1.025,87

582	2021-06-24 11:13:43	1.025,87
583	2021-06-24 11:13:45	1.025,87
584	2021-06-24 11:13:47	1.025,87
585	2021-06-24 11:13:51	1.025,87
586	2021-06-24 11:13:53	1.025,87
587	2021-06-24 11:13:55	1.025,87
588	2021-06-24 11:13:57	1.025,87
589	2021-06-24 11:14:03	1.025,87
590	2021-06-24 11:14:24	1.025,84
591	2021-06-24 11:14:26	1.025,84
592	2021-06-24 11:14:42	1.025,84
593	2021-06-24 11:14:44	1.025,84
594	2021-06-24 11:14:46	1.025,84
595	2021-06-24 11:14:48	1.025,84
596	2021-06-24 11:15:11	1.025,94
597	2021-06-24 11:15:13	1.025,94
598	2021-06-24 11:15:15	1.025,94
599	2021-06-24 11:15:17	1.025,94
600	2021-06-24 11:15:19	1.025,94
601	2021-06-24 11:15:21	1.025,94
602	2021-06-24 11:15:23	1.025,94
603	2021-06-24 11:15:25	1.025,94
604	2021-06-24 11:15:27	1.025,94
605	2021-06-24 11:15:29	1.025,94
606	2021-06-24 11:15:31	1.025,94
607	2021-06-24 11:15:33	1.025,94
608	2021-06-24 11:15:49	1.025,94
609	2021-06-24 11:15:57	1.025,94
610	2021-06-24 11:16:07	1.025,94
611	2021-06-24 11:16:11	1.025,87
612	2021-06-24 11:16:13	1.025,87
613	2021-06-24 11:16:15	1.025,87
614	2021-06-24 11:16:17	1.025,87
615	2021-06-24 11:16:19	1.025,87
616	2021-06-24 11:16:25	1.025,87
617	2021-06-24 11:16:27	1.025,87
618	2021-06-24 11:16:29	1.025,87
619	2021-06-24 11:16:31	1.025,87
620	2021-06-24 11:16:33	1.025,87
621	2021-06-24 11:16:35	1.025,87
622	2021-06-24 11:16:37	1.025,87
623	2021-06-24 11:16:39	1.025,87

624	2021-06-24 11:16:41	1.025,87
625	2021-06-24 11:16:43	1.025,87
626	2021-06-24 11:16:45	1.025,87
627	2021-06-24 11:17:10	1.025,87
628	2021-06-24 11:17:12	1.025,87
629	2021-06-24 11:17:14	1.025,87
630	2021-06-24 11:17:16	1.025,87
631	2021-06-24 11:17:18	1.025,87
632	2021-06-24 11:17:20	1.025,87
633	2021-06-24 11:17:22	1.025,87
634	2021-06-24 11:17:24	1.025,87
635	2021-06-24 11:17:26	1.025,87
636	2021-06-24 11:17:28	1.025,87
637	2021-06-24 11:17:30	1.025,87
638	2021-06-24 11:17:40	1.025,87
639	2021-06-24 11:17:42	1.025,87
640	2021-06-24 11:17:44	1.025,87
641	2021-06-24 11:17:46	1.025,87
642	2021-06-24 11:17:48	1.025,87
643	2021-06-24 11:17:55	1.025,87
644	2021-06-24 11:17:57	1.025,87
645	2021-06-24 11:17:59	1.025,87
646	2021-06-24 11:18:01	1.025,87
647	2021-06-24 11:18:03	1.025,87
648	2021-06-24 11:18:05	1.025,87
649	2021-06-24 11:18:07	1.025,87
650	2021-06-24 11:18:13	1.025,94
651	2021-06-24 11:18:15	1.025,94
652	2021-06-24 11:18:17	1.025,94
653	2021-06-24 11:18:19	1.025,94
654	2021-06-24 11:18:21	1.025,94
655	2021-06-24 11:18:25	1.025,94
656	2021-06-24 11:18:27	1.025,94
657	2021-06-24 11:18:29	1.025,94
658	2021-06-24 11:18:31	1.025,94
659	2021-06-24 11:18:33	1.025,94
660	2021-06-24 11:18:40	1.025,94
661	2021-06-24 11:18:42	1.025,94
662	2021-06-24 11:18:48	1.025,94
663	2021-06-24 11:18:50	1.025,94
664	2021-06-24 11:18:52	1.025,94
665	2021-06-24 11:18:54	1.025,94

666	2021-06-24 11:18:56	1.025,94
667	2021-06-24 11:19:08	1.025,94
668	2021-06-24 11:19:10	1.025,94
669	2021-06-24 11:19:12	1.025,94
670	2021-06-24 11:19:14	1.025,94
671	2021-06-24 11:19:55	1.025,94
672	2021-06-24 11:20:35	1.025,94
673	2021-06-24 11:20:37	1.025,94
674	2021-06-24 11:20:39	1.025,94
675	2021-06-24 11:20:41	1.025,94
676	2021-06-24 11:20:43	1.025,94
677	2021-06-24 11:20:45	1.025,94
678	2021-06-24 11:20:47	1.025,94
679	2021-06-24 11:20:49	1.025,94
680	2021-06-24 11:20:55	1.025,94
681	2021-06-24 11:20:57	1.025,94
682	2021-06-24 11:20:59	1.025,94
683	2021-06-24 11:21:01	1.025,94
684	2021-06-24 11:21:03	1.025,94
685	2021-06-24 11:21:05	1.025,94
686	2021-06-24 11:21:07	1.025,94
687	2021-06-24 11:21:11	1.025,94
688	2021-06-24 11:21:13	1.025,94
689	2021-06-24 11:21:27	1.025,94
690	2021-06-24 11:22:32	1.025,94
691	2021-06-24 11:22:34	1.025,94
692	2021-06-24 11:22:48	1.025,94
693	2021-06-24 11:22:50	1.025,94
694	2021-06-24 11:22:52	1.025,94
695	2021-06-24 11:22:54	1.025,94
696	2021-06-24 11:22:56	1.025,94
697	2021-06-24 11:22:58	1.025,94
698	2021-06-24 11:23:00	1.025,94
699	2021-06-24 11:23:02	1.025,94
700	2021-06-24 11:23:04	1.025,94
701	2021-06-24 11:23:11	1.025,91
702	2021-06-24 11:23:13	1.025,91
703	2021-06-24 11:23:15	1.025,91
704	2021-06-24 11:23:27	1.025,91
705	2021-06-24 11:23:29	1.025,91
706	2021-06-24 11:23:31	1.025,91
707	2021-06-24 11:23:43	1.025,91

708	2021-06-24 11:23:45	1.025,91
709	2021-06-24 11:23:47	1.025,91
710	2021-06-24 11:23:49	1.025,91
711	2021-06-24 11:23:55	1.025,91
712	2021-06-24 11:23:57	1.025,91
713	2021-06-24 11:23:59	1.025,91
714	2021-06-24 11:24:01	1.025,91
715	2021-06-24 11:24:03	1.025,91
716	2021-06-24 11:24:05	1.025,91
717	2021-06-24 11:24:07	1.025,91
718	2021-06-24 11:24:09	1.025,94
719	2021-06-24 11:24:11	1.025,94
720	2021-06-24 11:24:13	1.025,94
721	2021-06-24 11:24:15	1.025,94
722	2021-06-24 11:24:17	1.025,94
723	2021-06-24 11:24:19	1.025,94
724	2021-06-24 11:24:23	1.025,94
725	2021-06-24 11:24:25	1.025,94
726	2021-06-24 11:24:27	1.025,94
727	2021-06-24 11:24:29	1.025,94
728	2021-06-24 11:24:31	1.025,94
729	2021-06-24 11:24:33	1.025,94
730	2021-06-24 11:24:40	1.025,94
731	2021-06-24 11:24:42	1.025,94
732	2021-06-24 11:24:44	1.025,94
733	2021-06-24 11:24:46	1.025,94
734	2021-06-24 11:24:48	1.025,94
735	2021-06-24 11:24:50	1.025,94
736	2021-06-24 11:24:52	1.025,94
737	2021-06-24 11:24:54	1.025,94
738	2021-06-24 11:24:56	1.025,94
739	2021-06-24 11:24:58	1.025,94
740	2021-06-24 11:25:00	1.025,94
741	2021-06-24 11:25:02	1.025,94
742	2021-06-24 11:25:04	1.025,94
743	2021-06-24 11:25:08	1.025,97
744	2021-06-24 11:25:10	1.025,97
745	2021-06-24 11:25:12	1.025,97
746	2021-06-24 11:25:31	1.025,97
747	2021-06-24 11:26:03	1.025,97
748	2021-06-24 11:26:10	1.025,97
749	2021-06-24 11:26:12	1.025,97



750	2021-06-24 11:26:14	1.025,97
751	2021-06-24 11:26:16	1.025,97
752	2021-06-24 11:26:18	1.025,97
753	2021-06-24 11:26:20	1.025,97
754	2021-06-24 11:26:22	1.025,97
755	2021-06-24 11:26:24	1.025,97
756	2021-06-24 11:26:26	1.025,97
757	2021-06-24 11:26:28	1.025,97
758	2021-06-24 11:26:30	1.025,97
759	2021-06-24 11:26:34	1.025,97
760	2021-06-24 11:26:38	1.025,97
761	2021-06-24 11:26:40	1.025,97
762	2021-06-24 11:26:42	1.025,97
763	2021-06-24 11:26:44	1.025,97
764	2021-06-24 11:26:48	1.025,97
765	2021-06-24 11:27:01	1.025,97
766	2021-06-24 11:27:04	1.025,97
767	2021-06-24 11:27:05	1.025,97
768	2021-06-24 11:27:09	1.025,94
769	2021-06-24 11:27:11	1.025,94
770	2021-06-24 11:27:14	1.025,94
771	2021-06-24 11:27:16	1.025,94
772	2021-06-24 11:27:18	1.025,94
773	2021-06-24 11:27:20	1.025,94
774	2021-06-24 11:27:22	1.025,94
775	2021-06-24 11:27:26	1.025,94
776	2021-06-24 11:27:28	1.025,94
777	2021-06-24 11:27:30	1.025,94
778	2021-06-24 11:27:32	1.025,94
779	2021-06-24 11:27:34	1.025,94
780	2021-06-24 11:27:49	1.025,94
781	2021-06-24 11:27:55	1.025,94
782	2021-06-24 11:27:57	1.025,94
783	2021-06-24 11:27:59	1.025,94
784	2021-06-24 11:28:01	1.025,94
785	2021-06-24 11:28:03	1.025,94
786	2021-06-24 11:28:05	1.025,94
787	2021-06-24 11:28:07	1.025,94
788	2021-06-24 11:28:09	1.025,94
789	2021-06-24 11:28:11	1.025,94
790	2021-06-24 11:28:13	1.025,94
791	2021-06-24 11:28:15	1.025,94

792	2021-06-24 11:28:17	1.025,94
793	2021-06-24 11:28:19	1.025,94
794	2021-06-24 11:28:25	1.025,94
795	2021-06-24 11:28:27	1.025,94
796	2021-06-24 11:28:37	1.025,94
797	2021-06-24 11:28:39	1.025,94
798	2021-06-24 11:28:41	1.025,94
799	2021-06-24 11:28:43	1.025,94
800	2021-06-24 11:28:45	1.025,94
801	2021-06-24 11:28:47	1.025,94
802	2021-06-24 11:28:49	1.025,94
803	2021-06-24 11:28:51	1.025,94
804	2021-06-24 11:28:53	1.025,94
805	2021-06-24 11:29:03	1.025,94
806	2021-06-24 11:29:10	1.025,91
807	2021-06-24 11:29:12	1.025,91
808	2021-06-24 11:29:14	1.025,91
809	2021-06-24 11:29:16	1.025,91
810	2021-06-24 11:29:18	1.025,91
811	2021-06-24 11:29:20	1.025,91
812	2021-06-24 11:29:22	1.025,91
813	2021-06-24 11:29:24	1.025,91
814	2021-06-24 11:29:26	1.025,91
815	2021-06-24 11:29:28	1.025,91
816	2021-06-24 11:29:30	1.025,91
817	2021-06-24 11:29:32	1.025,91
818	2021-06-24 11:29:34	1.025,91
819	2021-06-24 11:29:46	1.025,91
820	2021-06-24 11:29:48	1.025,91
821	2021-06-24 11:30:03	1.025,91
822	2021-06-24 11:30:05	1.025,91
823	2021-06-24 11:30:07	1.025,91
824	2021-06-24 11:30:09	1.025,94
825	2021-06-24 11:30:11	1.025,94
826	2021-06-24 11:30:13	1.025,94
827	2021-06-24 11:30:15	1.025,94
828	2021-06-24 11:30:17	1.025,94
829	2021-06-24 11:30:19	1.025,94
830	2021-06-24 11:30:21	1.025,94
831	2021-06-24 11:30:23	1.025,94
832	2021-06-24 11:30:25	1.025,94
833	2021-06-24 11:30:27	1.025,94

834	2021-06-24 11:30:29	1.025,94	876	2021-06-24 11:33:28	1.025,84
835	2021-06-24 11:30:31	1.025,94	877	2021-06-24 11:33:30	1.025,84
836	2021-06-24 11:30:33	1.025,94	878	2021-06-24 11:34:00	1.025,84
837	2021-06-24 11:30:40	1.025,94	879	2021-06-24 11:34:02	1.025,84
838	2021-06-24 11:30:42	1.025,94	880	2021-06-24 11:34:25	1.025,94
839	2021-06-24 11:30:44	1.025,94	881	2021-06-24 11:34:27	1.025,94
840	2021-06-24 11:30:46	1.025,94	882	2021-06-24 11:34:29	1.025,94
841	2021-06-24 11:30:48	1.025,94	883	2021-06-24 11:34:31	1.025,94
842	2021-06-24 11:30:50	1.025,94	884	2021-06-24 11:34:33	1.025,94
843	2021-06-24 11:30:58	1.025,94	885	2021-06-24 11:34:35	1.025,94
844	2021-06-24 11:31:00	1.025,94	886	2021-06-24 11:34:37	1.025,94
845	2021-06-24 11:31:02	1.025,94	887	2021-06-24 11:34:55	1.025,94
846	2021-06-24 11:31:04	1.025,94	888	2021-06-24 11:34:57	1.025,94
847	2021-06-24 11:31:10	1.025,94	889	2021-06-24 11:35:24	1.025,87
848	2021-06-24 11:31:16	1.025,94	890	2021-06-24 11:35:26	1.025,87
849	2021-06-24 11:31:18	1.025,94	891	2021-06-24 11:35:28	1.025,87
850	2021-06-24 11:31:32	1.025,94	892	2021-06-24 11:35:30	1.025,87
851	2021-06-24 11:31:34	1.025,94	893	2021-06-24 11:35:32	1.025,87
852	2021-06-24 11:31:38	1.025,94	894	2021-06-24 11:35:34	1.025,87
853	2021-06-24 11:31:46	1.025,94	895	2021-06-24 11:36:01	1.025,87
854	2021-06-24 11:31:48	1.025,94	896	2021-06-24 11:36:04	1.025,87
855	2021-06-24 11:31:50	1.025,94	897	2021-06-24 11:36:06	1.025,87
856	2021-06-24 11:31:52	1.025,94	898	2021-06-24 11:36:10	1.025,94
857	2021-06-24 11:31:54	1.025,94	899	2021-06-24 11:36:12	1.025,94
858	2021-06-24 11:31:56	1.025,94	900	2021-06-24 11:36:14	1.025,94
859	2021-06-24 11:31:58	1.025,94	901	2021-06-24 11:36:16	1.025,94
860	2021-06-24 11:32:00	1.025,94	902	2021-06-24 11:36:18	1.025,94
861	2021-06-24 11:32:02	1.025,94	903	2021-06-24 11:36:20	1.025,94
862	2021-06-24 11:32:25	1.025,87	904	2021-06-24 11:39:08	1.025,87
863	2021-06-24 11:32:27	1.025,87	905	2021-06-24 11:39:16	1.025,87
864	2021-06-24 11:32:29	1.025,87	906	2021-06-24 11:39:18	1.025,87
865	2021-06-24 11:32:31	1.025,87	907	2021-06-24 11:39:24	1.025,87
866	2021-06-24 11:32:33	1.025,87	908	2021-06-24 11:39:47	1.025,87
867	2021-06-24 11:32:35	1.025,87	909	2021-06-24 11:39:51	1.025,87
868	2021-06-24 11:32:37	1.025,87	910	2021-06-24 11:39:53	1.025,87
869	2021-06-24 11:32:41	1.025,87	911	2021-06-24 11:40:05	1.025,87
870	2021-06-24 11:32:49	1.025,87	912	2021-06-24 11:40:07	1.025,87
871	2021-06-24 11:33:00	1.025,87	913	2021-06-24 11:40:09	1.025,87
872	2021-06-24 11:33:02	1.025,87	914	2021-06-24 11:40:11	1.025,87
873	2021-06-24 11:33:08	1.025,84	915	2021-06-24 11:40:13	1.025,87
874	2021-06-24 11:33:16	1.025,84	916	2021-06-24 11:40:15	1.025,87
875	2021-06-24 11:33:26	1.025,84	917	2021-06-24 11:40:17	1.025,87

918	2021-06-24 11:40:19	1.025,87
919	2021-06-24 11:40:26	1.025,87
920	2021-06-24 11:40:28	1.025,87
921	2021-06-24 11:40:30	1.025,87
922	2021-06-24 11:40:32	1.025,87
923	2021-06-24 11:40:34	1.025,87
924	2021-06-24 11:40:36	1.025,87
925	2021-06-24 11:40:38	1.025,87
926	2021-06-24 11:40:40	1.025,87
927	2021-06-24 11:40:42	1.025,87
928	2021-06-24 11:40:44	1.025,87
929	2021-06-24 11:40:46	1.025,87
930	2021-06-24 11:40:48	1.025,87
931	2021-06-24 11:40:50	1.025,87
932	2021-06-24 11:40:52	1.025,87
933	2021-06-24 11:40:54	1.025,87
934	2021-06-24 11:40:56	1.025,87
935	2021-06-24 11:40:58	1.025,87
936	2021-06-24 11:41:00	1.025,87
937	2021-06-24 11:41:02	1.025,87
938	2021-06-24 11:41:04	1.025,87
939	2021-06-24 11:42:03	1.025,84
940	2021-06-24 11:42:05	1.025,84
941	2021-06-24 11:42:07	1.025,84
942	2021-06-24 11:42:21	1.025,81
943	2021-06-24 11:42:23	1.025,81
944	2021-06-24 11:42:25	1.025,81
945	2021-06-24 11:42:27	1.025,81
946	2021-06-24 11:42:29	1.025,81
947	2021-06-24 11:42:31	1.025,81
948	2021-06-24 11:42:40	1.025,81
949	2021-06-24 11:42:42	1.025,81
950	2021-06-24 11:42:44	1.025,81
951	2021-06-24 11:42:46	1.025,81
952	2021-06-24 11:42:48	1.025,81
953	2021-06-24 11:42:50	1.025,81
954	2021-06-24 11:43:02	1.025,81
955	2021-06-24 11:43:04	1.025,81
956	2021-06-24 11:43:06	1.025,81
957	2021-06-24 11:43:10	1.025,84
958	2021-06-24 11:43:12	1.025,84
959	2021-06-24 11:43:14	1.025,84

960	2021-06-24 11:43:16	1.025,84
961	2021-06-24 11:43:18	1.025,84
962	2021-06-24 11:43:25	1.025,84
963	2021-06-24 11:43:27	1.025,84
964	2021-06-24 11:43:29	1.025,84
965	2021-06-24 11:43:37	1.025,84
966	2021-06-24 11:43:39	1.025,84
967	2021-06-24 11:43:41	1.025,84
968	2021-06-24 11:43:43	1.025,84
969	2021-06-24 11:43:53	1.025,84
970	2021-06-24 11:43:55	1.025,84
971	2021-06-24 11:44:03	1.025,84
972	2021-06-24 11:44:29	1.025,84
973	2021-06-24 11:44:31	1.025,84
974	2021-06-24 11:44:33	1.025,84
975	2021-06-24 11:44:39	1.025,84
976	2021-06-24 11:44:41	1.025,84
977	2021-06-24 11:44:47	1.025,84
978	2021-06-24 11:44:49	1.025,84
979	2021-06-24 11:44:56	1.025,84
980	2021-06-24 11:44:58	1.025,84
981	2021-06-24 11:45:00	1.025,84
982	2021-06-24 11:45:02	1.025,84
983	2021-06-24 11:45:04	1.025,84
984	2021-06-24 11:45:06	1.025,84
985	2021-06-24 11:45:08	1.025,84
986	2021-06-24 11:45:10	1.025,84
987	2021-06-24 11:45:12	1.025,84
988	2021-06-24 11:45:14	1.025,84
989	2021-06-24 11:45:16	1.025,84
990	2021-06-24 11:45:18	1.025,84
991	2021-06-24 11:45:20	1.025,84
992	2021-06-24 11:45:22	1.025,84
993	2021-06-24 11:45:24	1.025,84
994	2021-06-24 11:45:44	1.025,84
995	2021-06-24 11:45:46	1.025,84
996	2021-06-24 11:45:48	1.025,84
997	2021-06-24 11:45:56	1.025,84
998	2021-06-24 11:45:58	1.025,84
999	2021-06-24 11:46:00	1.025,84
1000	2021-06-24 11:46:02	1.025,84
1001	2021-06-24 11:46:04	1.025,84

1002	2021-06-24 11:46:06	1.025,84	1044	2021-06-24 11:51:10	1.025,74
1003	2021-06-24 11:46:12	1.025,81	1045	2021-06-24 11:51:12	1.025,74
1004	2021-06-24 11:46:33	1.025,81	1046	2021-06-24 11:51:14	1.025,74
1005	2021-06-24 11:46:35	1.025,81	1047	2021-06-24 11:51:22	1.025,74
1006	2021-06-24 11:47:26	1.025,77	1048	2021-06-24 11:51:24	1.025,74
1007	2021-06-24 11:47:28	1.025,77	1049	2021-06-24 11:51:26	1.025,74
1008	2021-06-24 11:47:30	1.025,77	1050	2021-06-24 11:51:28	1.025,74
1009	2021-06-24 11:47:32	1.025,77	1051	2021-06-24 11:51:30	1.025,74
1010	2021-06-24 11:47:34	1.025,77	1052	2021-06-24 11:51:32	1.025,74
1011	2021-06-24 11:47:36	1.025,77	1053	2021-06-24 11:51:34	1.025,74
1012	2021-06-24 11:47:38	1.025,77	1054	2021-06-24 11:51:51	1.025,74
1013	2021-06-24 11:47:40	1.025,77	1055	2021-06-24 11:51:53	1.025,74
1014	2021-06-24 11:47:42	1.025,77	1056	2021-06-24 11:51:57	1.025,74
1015	2021-06-24 11:47:44	1.025,77	1057	2021-06-24 11:51:59	1.025,74
1016	2021-06-24 11:47:46	1.025,77	1058	2021-06-24 11:52:05	1.025,74
1017	2021-06-24 11:47:48	1.025,77	1059	2021-06-24 11:52:09	1.025,67
1018	2021-06-24 11:48:40	1.025,74	1060	2021-06-24 11:52:11	1.025,67
1019	2021-06-24 11:48:42	1.025,74	1061	2021-06-24 11:52:13	1.025,67
1020	2021-06-24 11:48:44	1.025,74	1062	2021-06-24 11:52:15	1.025,67
1021	2021-06-24 11:48:46	1.025,74	1063	2021-06-24 11:52:17	1.025,67
1022	2021-06-24 11:48:48	1.025,74	1064	2021-06-24 11:52:19	1.025,67
1023	2021-06-24 11:48:50	1.025,74	1065	2021-06-24 11:52:26	1.025,67
1024	2021-06-24 11:48:52	1.025,74	1066	2021-06-24 11:52:28	1.025,67
1025	2021-06-24 11:48:54	1.025,74	1067	2021-06-24 11:52:30	1.025,67
1026	2021-06-24 11:48:56	1.025,74	1068	2021-06-24 11:52:32	1.025,67
1027	2021-06-24 11:48:58	1.025,74	1069	2021-06-24 11:52:42	1.025,67
1028	2021-06-24 11:49:00	1.025,74	1070	2021-06-24 11:52:50	1.025,67
1029	2021-06-24 11:49:02	1.025,74	1071	2021-06-24 11:52:52	1.025,67
1030	2021-06-24 11:49:04	1.025,74	1072	2021-06-24 11:52:54	1.025,67
1031	2021-06-24 11:49:06	1.025,74	1073	2021-06-24 11:52:56	1.025,67
1032	2021-06-24 11:49:31	1.025,70	1074	2021-06-24 11:52:58	1.025,67
1033	2021-06-24 11:49:59	1.025,70	1075	2021-06-24 11:53:00	1.025,67
1034	2021-06-24 11:50:01	1.025,70	1076	2021-06-24 11:53:04	1.025,67
1035	2021-06-24 11:50:03	1.025,70	1077	2021-06-24 11:53:16	1.025,60
1036	2021-06-24 11:50:28	1.025,74	1078	2021-06-24 11:53:20	1.025,60
1037	2021-06-24 11:50:30	1.025,74	1079	2021-06-24 11:53:26	1.025,60
1038	2021-06-24 11:50:38	1.025,74	1080	2021-06-24 11:53:44	1.025,60
1039	2021-06-24 11:50:40	1.025,74	1081	2021-06-24 11:54:03	1.025,60
1040	2021-06-24 11:50:56	1.025,74	1082	2021-06-24 11:54:05	1.025,60
1041	2021-06-24 11:50:58	1.025,74	1083	2021-06-24 11:54:09	1.025,64
1042	2021-06-24 11:51:00	1.025,74	1084	2021-06-24 11:54:11	1.025,64
1043	2021-06-24 11:51:08	1.025,74	1085	2021-06-24 11:54:13	1.025,64

1086	2021-06-24 11:54:15	1.025,64
1087	2021-06-24 11:54:17	1.025,64
1088	2021-06-24 11:54:19	1.025,64
1089	2021-06-24 11:54:25	1.025,64
1090	2021-06-24 11:54:40	1.025,64
1091	2021-06-24 11:54:42	1.025,64
1092	2021-06-24 11:54:44	1.025,64
1093	2021-06-24 11:54:46	1.025,64
1094	2021-06-24 11:54:48	1.025,64
1095	2021-06-24 11:54:56	1.025,64
1096	2021-06-24 11:55:06	1.025,64
1097	2021-06-24 11:55:10	1.025,57
1098	2021-06-24 11:55:16	1.025,57
1099	2021-06-24 11:55:18	1.025,57
1100	2021-06-24 11:55:31	1.025,57
1101	2021-06-24 11:55:33	1.025,57
1102	2021-06-24 11:55:49	1.025,57
1103	2021-06-24 11:55:51	1.025,57
1104	2021-06-24 11:55:55	1.025,57
1105	2021-06-24 11:55:57	1.025,57
1106	2021-06-24 11:55:59	1.025,57
1107	2021-06-24 11:56:03	1.025,57
1108	2021-06-24 11:56:39	1.025,47
1109	2021-06-24 11:56:56	1.025,47
1110	2021-06-24 11:56:58	1.025,47
1111	2021-06-24 11:57:04	1.025,47
1112	2021-06-24 11:57:08	1.025,50
1113	2021-06-24 11:57:14	1.025,50
1114	2021-06-24 11:57:16	1.025,50
1115	2021-06-24 11:57:22	1.025,50
1116	2021-06-24 11:57:24	1.025,50
1117	2021-06-24 11:57:26	1.025,50
1118	2021-06-24 11:57:34	1.025,50
1119	2021-06-24 11:57:40	1.025,50
1120	2021-06-24 11:57:42	1.025,50
1121	2021-06-24 11:57:54	1.025,50
1122	2021-06-24 11:57:56	1.025,50
1123	2021-06-24 11:57:58	1.025,50
1124	2021-06-24 11:58:04	1.025,50
1125	2021-06-24 11:58:06	1.025,50
1126	2021-06-24 11:58:10	1.025,53
1127	2021-06-24 11:58:12	1.025,53

1128	2021-06-24 11:58:31	1.025,53
1129	2021-06-24 11:58:33	1.025,53
1130	2021-06-24 11:58:35	1.025,53
1131	2021-06-24 11:58:37	1.025,53
1132	2021-06-24 11:58:39	1.025,53
1133	2021-06-24 11:58:41	1.025,53
1134	2021-06-24 11:58:43	1.025,53
1135	2021-06-24 11:58:45	1.025,53
1136	2021-06-24 11:58:51	1.025,53
1137	2021-06-24 11:58:53	1.025,53
1138	2021-06-24 11:58:57	1.025,53
1139	2021-06-24 11:59:24	1.025,53
1140	2021-06-24 11:59:26	1.025,53
1141	2021-06-24 11:59:28	1.025,53
1142	2021-06-24 11:59:30	1.025,53
1143	2021-06-24 11:59:32	1.025,53
1144	2021-06-24 11:59:55	1.025,53
1145	2021-06-24 11:59:57	1.025,53
1146	2021-06-24 11:59:59	1.025,53
1147	2021-06-24 12:00:01	1.025,53
1148	2021-06-24 12:00:07	1.025,53
1149	2021-06-24 12:00:09	1.025,53
1150	2021-06-24 12:00:11	1.025,57
1151	2021-06-24 12:00:13	1.025,57
1152	2021-06-24 12:00:15	1.025,57
1153	2021-06-24 12:00:21	1.025,57
1154	2021-06-24 12:00:23	1.025,57
1155	2021-06-24 12:00:41	1.025,57
1156	2021-06-24 12:00:43	1.025,57
1157	2021-06-24 12:00:45	1.025,57
1158	2021-06-24 12:00:47	1.025,57
1159	2021-06-24 12:00:49	1.025,57
1160	2021-06-24 12:00:51	1.025,57
1161	2021-06-24 12:00:53	1.025,57
1162	2021-06-24 12:00:55	1.025,57
1163	2021-06-24 12:00:59	1.025,57
1164	2021-06-24 12:01:01	1.025,57
1165	2021-06-24 12:01:03	1.025,57
1166	2021-06-24 12:01:05	1.025,57
1167	2021-06-24 12:01:15	1.025,57
1168	2021-06-24 12:01:26	1.025,57
1169	2021-06-24 12:01:28	1.025,57

1170	2021-06-24 12:01:34	1.025,57	1212	2021-06-24 12:05:01	1.025,60
1171	2021-06-24 12:01:36	1.025,57	1213	2021-06-24 12:05:21	1.025,60
1172	2021-06-24 12:01:38	1.025,57	1214	2021-06-24 12:05:29	1.025,60
1173	2021-06-24 12:01:40	1.025,57	1215	2021-06-24 12:05:37	1.025,60
1174	2021-06-24 12:01:52	1.025,57	1216	2021-06-24 12:05:39	1.025,60
1175	2021-06-24 12:01:54	1.025,57	1217	2021-06-24 12:05:41	1.025,60
1176	2021-06-24 12:01:58	1.025,57	1218	2021-06-24 12:05:43	1.025,60
1177	2021-06-24 12:02:00	1.025,57	1219	2021-06-24 12:05:45	1.025,60
1178	2021-06-24 12:02:11	1.025,60	1220	2021-06-24 12:05:47	1.025,60
1179	2021-06-24 12:02:13	1.025,60	1221	2021-06-24 12:05:49	1.025,60
1180	2021-06-24 12:02:15	1.025,60	1222	2021-06-24 12:05:56	1.025,60
1181	2021-06-24 12:02:17	1.025,60	1223	2021-06-24 12:05:58	1.025,60
1182	2021-06-24 12:02:19	1.025,60	1224	2021-06-24 12:06:00	1.025,60
1183	2021-06-24 12:02:21	1.025,60	1225	2021-06-24 12:06:02	1.025,60
1184	2021-06-24 12:02:23	1.025,60	1226	2021-06-24 12:06:06	1.025,60
1185	2021-06-24 12:02:25	1.025,60	1227	2021-06-24 12:06:14	1.025,64
1186	2021-06-24 12:03:09	1.025,57	1228	2021-06-24 12:06:16	1.025,64
1187	2021-06-24 12:03:13	1.025,57	1229	2021-06-24 12:06:28	1.025,64
1188	2021-06-24 12:03:15	1.025,57	1230	2021-06-24 12:06:30	1.025,64
1189	2021-06-24 12:03:17	1.025,57	1231	2021-06-24 12:06:32	1.025,64
1190	2021-06-24 12:03:19	1.025,57	1232	2021-06-24 12:06:41	1.025,64
1191	2021-06-24 12:03:21	1.025,57	1233	2021-06-24 12:06:43	1.025,64
1192	2021-06-24 12:03:25	1.025,57	1234	2021-06-24 12:06:45	1.025,64
1193	2021-06-24 12:03:27	1.025,57	1235	2021-06-24 12:06:47	1.025,64
1194	2021-06-24 12:03:33	1.025,57	1236	2021-06-24 12:07:01	1.025,64
1195	2021-06-24 12:03:46	1.025,57	1237	2021-06-24 12:07:03	1.025,64
1196	2021-06-24 12:03:50	1.025,57	1238	2021-06-24 12:07:05	1.025,64
1197	2021-06-24 12:03:52	1.025,57	1239	2021-06-24 12:07:07	1.025,64
1198	2021-06-24 12:03:56	1.025,57	1240	2021-06-24 12:07:49	1.025,64
1199	2021-06-24 12:03:58	1.025,57	1241	2021-06-24 12:07:51	1.025,64
1200	2021-06-24 12:04:00	1.025,57	1242	2021-06-24 12:07:53	1.025,64
1201	2021-06-24 12:04:02	1.025,57	1243	2021-06-24 12:07:55	1.025,64
1202	2021-06-24 12:04:04	1.025,57	1244	2021-06-24 12:07:57	1.025,64
1203	2021-06-24 12:04:06	1.025,57	1245	2021-06-24 12:07:59	1.025,64
1204	2021-06-24 12:04:12	1.025,60	1246	2021-06-24 12:08:01	1.025,64
1205	2021-06-24 12:04:14	1.025,60	1247	2021-06-24 12:08:03	1.025,64
1206	2021-06-24 12:04:25	1.025,60	1248	2021-06-24 12:08:10	1.025,64
1207	2021-06-24 12:04:27	1.025,60	1249	2021-06-24 12:08:12	1.025,64
1208	2021-06-24 12:04:37	1.025,60	1250	2021-06-24 12:08:22	1.025,64
1209	2021-06-24 12:04:39	1.025,60	1251	2021-06-24 12:08:34	1.025,64
1210	2021-06-24 12:04:41	1.025,60	1252	2021-06-24 12:08:36	1.025,64
1211	2021-06-24 12:04:53	1.025,60	1253	2021-06-24 12:08:38	1.025,64

1254	2021-06-24 12:08:40	1.025,64	1296	2021-06-24 12:11:37	1.025,64
1255	2021-06-24 12:08:42	1.025,64	1297	2021-06-24 12:11:39	1.025,64
1256	2021-06-24 12:08:44	1.025,64	1298	2021-06-24 12:11:41	1.025,64
1257	2021-06-24 12:08:46	1.025,64	1299	2021-06-24 12:11:43	1.025,64
1258	2021-06-24 12:08:55	1.025,64	1300	2021-06-24 12:11:45	1.025,64
1259	2021-06-24 12:08:57	1.025,64	1301	2021-06-24 12:11:47	1.025,64
1260	2021-06-24 12:08:59	1.025,64	1302	2021-06-24 12:11:49	1.025,64
1261	2021-06-24 12:09:05	1.025,64	1303	2021-06-24 12:11:55	1.025,64
1262	2021-06-24 12:09:07	1.025,64	1304	2021-06-24 12:11:57	1.025,64
1263	2021-06-24 12:09:11	1.025,67	1305	2021-06-24 12:11:59	1.025,64
1264	2021-06-24 12:09:13	1.025,67	1306	2021-06-24 12:12:03	1.025,64
1265	2021-06-24 12:09:19	1.025,67	1307	2021-06-24 12:12:05	1.025,64
1266	2021-06-24 12:09:21	1.025,67	1308	2021-06-24 12:12:07	1.025,64
1267	2021-06-24 12:09:23	1.025,67	1309	2021-06-24 12:12:11	1.025,67
1268	2021-06-24 12:09:25	1.025,67	1310	2021-06-24 12:12:19	1.025,67
1269	2021-06-24 12:09:27	1.025,67	1311	2021-06-24 12:12:29	1.025,67
1270	2021-06-24 12:09:45	1.025,67	1312	2021-06-24 12:12:40	1.025,67
1271	2021-06-24 12:09:47	1.025,67	1313	2021-06-24 12:12:42	1.025,67
1272	2021-06-24 12:09:49	1.025,67	1314	2021-06-24 12:12:44	1.025,67
1273	2021-06-24 12:09:51	1.025,67	1315	2021-06-24 12:12:48	1.025,67
1274	2021-06-24 12:09:53	1.025,67	1316	2021-06-24 12:12:50	1.025,67
1275	2021-06-24 12:10:01	1.025,67	1317	2021-06-24 12:12:54	1.025,67
1276	2021-06-24 12:10:03	1.025,67	1318	2021-06-24 12:13:06	1.025,67
1277	2021-06-24 12:10:05	1.025,67	1319	2021-06-24 12:13:08	1.025,64
1278	2021-06-24 12:10:07	1.025,67	1320	2021-06-24 12:13:33	1.025,64
1279	2021-06-24 12:10:09	1.025,64	1321	2021-06-24 12:13:35	1.025,64
1280	2021-06-24 12:10:19	1.025,64	1322	2021-06-24 12:13:37	1.025,64
1281	2021-06-24 12:10:38	1.025,64	1323	2021-06-24 12:13:39	1.025,64
1282	2021-06-24 12:10:40	1.025,64	1324	2021-06-24 12:13:57	1.025,64
1283	2021-06-24 12:10:50	1.025,64	1325	2021-06-24 12:14:03	1.025,64
1284	2021-06-24 12:10:56	1.025,64	1326	2021-06-24 12:14:16	1.025,67
1285	2021-06-24 12:11:04	1.025,64	1327	2021-06-24 12:14:18	1.025,67
1286	2021-06-24 12:11:11	1.025,64	1328	2021-06-24 12:14:24	1.025,67
1287	2021-06-24 12:11:13	1.025,64	1329	2021-06-24 12:14:26	1.025,67
1288	2021-06-24 12:11:15	1.025,64	1330	2021-06-24 12:14:33	1.025,67
1289	2021-06-24 12:11:17	1.025,64	1331	2021-06-24 12:14:37	1.025,67
1290	2021-06-24 12:11:19	1.025,64	1332	2021-06-24 12:14:39	1.025,67
1291	2021-06-24 12:11:21	1.025,64	1333	2021-06-24 12:14:41	1.025,67
1292	2021-06-24 12:11:23	1.025,64	1334	2021-06-24 12:14:47	1.025,67
1293	2021-06-24 12:11:31	1.025,64	1335	2021-06-24 12:14:49	1.025,67
1294	2021-06-24 12:11:33	1.025,64	1336	2021-06-24 12:15:04	1.025,67
1295	2021-06-24 12:11:35	1.025,64	1337	2021-06-24 12:15:14	1.025,67

1338	2021-06-24 12:15:20	1.025,67	1380	2021-06-24 12:18:04	1.025,67
1339	2021-06-24 12:15:22	1.025,67	1381	2021-06-24 12:18:06	1.025,67
1340	2021-06-24 12:15:24	1.025,67	1382	2021-06-24 12:18:08	1.025,67
1341	2021-06-24 12:15:26	1.025,67	1383	2021-06-24 12:18:14	1.025,64
1342	2021-06-24 12:15:28	1.025,67	1384	2021-06-24 12:18:22	1.025,64
1343	2021-06-24 12:15:30	1.025,67	1385	2021-06-24 12:18:26	1.025,64
1344	2021-06-24 12:15:32	1.025,67	1386	2021-06-24 12:18:28	1.025,64
1345	2021-06-24 12:15:34	1.025,67	1387	2021-06-24 12:18:30	1.025,64
1346	2021-06-24 12:15:41	1.025,67	1388	2021-06-24 12:18:34	1.025,64
1347	2021-06-24 12:15:43	1.025,67	1389	2021-06-24 12:18:41	1.025,64
1348	2021-06-24 12:15:45	1.025,67	1390	2021-06-24 12:18:43	1.025,64
1349	2021-06-24 12:15:55	1.025,67	1391	2021-06-24 12:18:45	1.025,64
1350	2021-06-24 12:15:59	1.025,67	1392	2021-06-24 12:18:47	1.025,64
1351	2021-06-24 12:16:05	1.025,67	1393	2021-06-24 12:18:49	1.025,64
1352	2021-06-24 12:16:09	1.025,70	1394	2021-06-24 12:18:51	1.025,64
1353	2021-06-24 12:16:11	1.025,70	1395	2021-06-24 12:18:53	1.025,64
1354	2021-06-24 12:16:17	1.025,70	1396	2021-06-24 12:18:55	1.025,64
1355	2021-06-24 12:16:19	1.025,70	1397	2021-06-24 12:18:57	1.025,64
1356	2021-06-24 12:16:27	1.025,70	1398	2021-06-24 12:18:59	1.025,64
1357	2021-06-24 12:16:29	1.025,70	1399	2021-06-24 12:19:01	1.025,64
1358	2021-06-24 12:16:31	1.025,70	1400	2021-06-24 12:19:03	1.025,64
1359	2021-06-24 12:16:37	1.025,70	1401	2021-06-24 12:19:05	1.025,64
1360	2021-06-24 12:16:39	1.025,70	1402	2021-06-24 12:19:19	1.025,64
1361	2021-06-24 12:16:45	1.025,70	1403	2021-06-24 12:19:25	1.025,64
1362	2021-06-24 12:16:47	1.025,70	1404	2021-06-24 12:19:27	1.025,64
1363	2021-06-24 12:16:49	1.025,70	1405	2021-06-24 12:19:29	1.025,64
1364	2021-06-24 12:16:55	1.025,70	1406	2021-06-24 12:19:31	1.025,64
1365	2021-06-24 12:16:57	1.025,70	1407	2021-06-24 12:19:33	1.025,64
1366	2021-06-24 12:17:03	1.025,70	1408	2021-06-24 12:19:35	1.025,64
1367	2021-06-24 12:17:05	1.025,70	1409	2021-06-24 12:19:37	1.025,64
1368	2021-06-24 12:17:17	1.025,67	1410	2021-06-24 12:19:45	1.025,64
1369	2021-06-24 12:17:19	1.025,67	1411	2021-06-24 12:19:47	1.025,64
1370	2021-06-24 12:17:23	1.025,67	1412	2021-06-24 12:19:55	1.025,64
1371	2021-06-24 12:17:25	1.025,67	1413	2021-06-24 12:19:57	1.025,64
1372	2021-06-24 12:17:27	1.025,67	1414	2021-06-24 12:19:59	1.025,64
1373	2021-06-24 12:17:29	1.025,67	1415	2021-06-24 12:20:10	1.025,67
1374	2021-06-24 12:17:37	1.025,67	1416	2021-06-24 12:20:12	1.025,67
1375	2021-06-24 12:17:39	1.025,67	1417	2021-06-24 12:20:14	1.025,67
1376	2021-06-24 12:17:41	1.025,67	1418	2021-06-24 12:20:16	1.025,67
1377	2021-06-24 12:17:43	1.025,67	1419	2021-06-24 12:20:18	1.025,67
1378	2021-06-24 12:17:45	1.025,67	1420	2021-06-24 12:20:20	1.025,67
1379	2021-06-24 12:17:47	1.025,67	1421	2021-06-24 12:20:28	1.025,67



1422	2021-06-24 12:20:30	1.025,67	1464	2021-06-24 12:24:48	1.025,74
1423	2021-06-24 12:20:48	1.025,67	1465	2021-06-24 12:24:50	1.025,74
1424	2021-06-24 12:21:01	1.025,67	1466	2021-06-24 12:25:02	1.025,74
1425	2021-06-24 12:21:03	1.025,67	1467	2021-06-24 12:25:04	1.025,74
1426	2021-06-24 12:21:05	1.025,67	1468	2021-06-24 12:25:06	1.025,74
1427	2021-06-24 12:21:15	1.025,60	1469	2021-06-24 12:25:12	1.025,67
1428	2021-06-24 12:21:33	1.025,60	1470	2021-06-24 12:25:16	1.025,67
1429	2021-06-24 12:21:41	1.025,60	1471	2021-06-24 12:25:18	1.025,67
1430	2021-06-24 12:21:43	1.025,60	1472	2021-06-24 12:25:25	1.025,67
1431	2021-06-24 12:21:45	1.025,60	1473	2021-06-24 12:25:27	1.025,67
1432	2021-06-24 12:21:53	1.025,60	1474	2021-06-24 12:25:29	1.025,67
1433	2021-06-24 12:21:59	1.025,60	1475	2021-06-24 12:25:31	1.025,67
1434	2021-06-24 12:22:03	1.025,60	1476	2021-06-24 12:25:33	1.025,67
1435	2021-06-24 12:22:05	1.025,60	1477	2021-06-24 12:25:35	1.025,67
1436	2021-06-24 12:22:07	1.025,60	1478	2021-06-24 12:25:37	1.025,67
1437	2021-06-24 12:22:09	1.025,64	1479	2021-06-24 12:25:39	1.025,67
1438	2021-06-24 12:22:13	1.025,64	1480	2021-06-24 12:25:41	1.025,67
1439	2021-06-24 12:22:19	1.025,64	1481	2021-06-24 12:25:43	1.025,67
1440	2021-06-24 12:22:38	1.025,64	1482	2021-06-24 12:25:45	1.025,67
1441	2021-06-24 12:22:40	1.025,64	1483	2021-06-24 12:25:47	1.025,67
1442	2021-06-24 12:22:46	1.025,64	1484	2021-06-24 12:25:49	1.025,67
1443	2021-06-24 12:22:48	1.025,64	1485	2021-06-24 12:25:51	1.025,67
1444	2021-06-24 12:22:50	1.025,64	1486	2021-06-24 12:25:53	1.025,67
1445	2021-06-24 12:23:11	1.025,70	1487	2021-06-24 12:25:55	1.025,67
1446	2021-06-24 12:23:13	1.025,70	1488	2021-06-24 12:26:10	1.025,64
1447	2021-06-24 12:23:15	1.025,70	1489	2021-06-24 12:26:12	1.025,64
1448	2021-06-24 12:23:21	1.025,70	1490	2021-06-24 12:26:14	1.025,64
1449	2021-06-24 12:23:23	1.025,70	1491	2021-06-24 12:26:16	1.025,64
1450	2021-06-24 12:23:25	1.025,70	1492	2021-06-24 12:26:18	1.025,64
1451	2021-06-24 12:23:27	1.025,70	1493	2021-06-24 12:26:20	1.025,64
1452	2021-06-24 12:23:29	1.025,70	1494	2021-06-24 12:26:22	1.025,64
1453	2021-06-24 12:23:31	1.025,70	1495	2021-06-24 12:26:24	1.025,64
1454	2021-06-24 12:23:35	1.025,70	1496	2021-06-24 12:26:28	1.025,64
1455	2021-06-24 12:24:11	1.025,74	1497	2021-06-24 12:26:30	1.025,64
1456	2021-06-24 12:24:21	1.025,74	1498	2021-06-24 12:26:32	1.025,64
1457	2021-06-24 12:24:23	1.025,74	1499	2021-06-24 12:26:34	1.025,64
1458	2021-06-24 12:24:25	1.025,74	1500	2021-06-24 12:26:38	1.025,64
1459	2021-06-24 12:24:27	1.025,74	1501	2021-06-24 12:26:40	1.025,64
1460	2021-06-24 12:24:29	1.025,74	1502	2021-06-24 12:26:42	1.025,64
1461	2021-06-24 12:24:31	1.025,74	1503	2021-06-24 12:26:44	1.025,64
1462	2021-06-24 12:24:33	1.025,74	1504	2021-06-24 12:26:46	1.025,64
1463	2021-06-24 12:24:46	1.025,74	1505	2021-06-24 12:26:48	1.025,64

1506	2021-06-24 12:27:02	1.025,64	1548	2021-06-24 12:29:59	1.025,53
1507	2021-06-24 12:27:08	1.025,70	1549	2021-06-24 12:30:01	1.025,53
1508	2021-06-24 12:27:14	1.025,70	1550	2021-06-24 12:30:03	1.025,53
1509	2021-06-24 12:27:16	1.025,70	1551	2021-06-24 12:30:11	1.025,50
1510	2021-06-24 12:27:18	1.025,70	1552	2021-06-24 12:30:13	1.025,50
1511	2021-06-24 12:27:26	1.025,70	1553	2021-06-24 12:30:15	1.025,50
1512	2021-06-24 12:27:51	1.025,70	1554	2021-06-24 12:30:17	1.025,50
1513	2021-06-24 12:27:53	1.025,70	1555	2021-06-24 12:30:19	1.025,50
1514	2021-06-24 12:27:55	1.025,70	1556	2021-06-24 12:30:25	1.025,50
1515	2021-06-24 12:28:01	1.025,70	1557	2021-06-24 12:30:40	1.025,50
1516	2021-06-24 12:28:03	1.025,70	1558	2021-06-24 12:30:42	1.025,50
1517	2021-06-24 12:28:07	1.025,70	1559	2021-06-24 12:30:44	1.025,50
1518	2021-06-24 12:28:09	1.025,60	1560	2021-06-24 12:30:46	1.025,50
1519	2021-06-24 12:28:11	1.025,60	1561	2021-06-24 12:30:56	1.025,50
1520	2021-06-24 12:28:13	1.025,60	1562	2021-06-24 12:31:00	1.025,50
1521	2021-06-24 12:28:17	1.025,60	1563	2021-06-24 12:31:06	1.025,50
1522	2021-06-24 12:28:19	1.025,60	1564	2021-06-24 12:31:08	1.025,57
1523	2021-06-24 12:28:32	1.025,60	1565	2021-06-24 12:31:10	1.025,57
1524	2021-06-24 12:28:36	1.025,60	1566	2021-06-24 12:31:12	1.025,57
1525	2021-06-24 12:28:38	1.025,60	1567	2021-06-24 12:31:14	1.025,57
1526	2021-06-24 12:28:40	1.025,60	1568	2021-06-24 12:31:16	1.025,57
1527	2021-06-24 12:28:52	1.025,60	1569	2021-06-24 12:31:18	1.025,57
1528	2021-06-24 12:29:00	1.025,60	1570	2021-06-24 12:31:26	1.025,57
1529	2021-06-24 12:29:02	1.025,60	1571	2021-06-24 12:31:28	1.025,57
1530	2021-06-24 12:29:04	1.025,60	1572	2021-06-24 12:31:30	1.025,57
1531	2021-06-24 12:29:10	1.025,53	1573	2021-06-24 12:31:32	1.025,57
1532	2021-06-24 12:29:12	1.025,53	1574	2021-06-24 12:31:38	1.025,57
1533	2021-06-24 12:29:14	1.025,53	1575	2021-06-24 12:31:40	1.025,57
1534	2021-06-24 12:29:16	1.025,53	1576	2021-06-24 12:31:42	1.025,57
1535	2021-06-24 12:29:20	1.025,53	1577	2021-06-24 12:31:44	1.025,57
1536	2021-06-24 12:29:22	1.025,53	1578	2021-06-24 12:31:46	1.025,57
1537	2021-06-24 12:29:24	1.025,53	1579	2021-06-24 12:32:23	1.025,50
1538	2021-06-24 12:29:26	1.025,53	1580	2021-06-24 12:32:31	1.025,50
1539	2021-06-24 12:29:28	1.025,53	1581	2021-06-24 12:32:41	1.025,50
1540	2021-06-24 12:29:30	1.025,53	1582	2021-06-24 12:32:43	1.025,50
1541	2021-06-24 12:29:32	1.025,53	1583	2021-06-24 12:32:45	1.025,50
1542	2021-06-24 12:29:34	1.025,53	1584	2021-06-24 12:32:47	1.025,50
1543	2021-06-24 12:29:36	1.025,53	1585	2021-06-24 12:33:04	1.025,50
1544	2021-06-24 12:29:38	1.025,53	1586	2021-06-24 12:33:28	1.025,40
1545	2021-06-24 12:29:44	1.025,53	1587	2021-06-24 12:33:30	1.025,40
1546	2021-06-24 12:29:55	1.025,53	1588	2021-06-24 12:33:32	1.025,40
1547	2021-06-24 12:29:57	1.025,53	1589	2021-06-24 12:33:34	1.025,40

1590	2021-06-24 12:33:50	1.025,40	1632	2021-06-24 12:37:17	1.025,26
1591	2021-06-24 12:33:52	1.025,40	1633	2021-06-24 12:37:19	1.025,26
1592	2021-06-24 12:33:54	1.025,40	1634	2021-06-24 12:37:34	1.025,26
1593	2021-06-24 12:33:56	1.025,40	1635	2021-06-24 12:37:36	1.025,26
1594	2021-06-24 12:34:00	1.025,40	1636	2021-06-24 12:37:38	1.025,26
1595	2021-06-24 12:34:02	1.025,40	1637	2021-06-24 12:37:40	1.025,26
1596	2021-06-24 12:34:04	1.025,40	1638	2021-06-24 12:37:42	1.025,26
1597	2021-06-24 12:34:06	1.025,40	1639	2021-06-24 12:37:44	1.025,26
1598	2021-06-24 12:34:10	1.025,33	1640	2021-06-24 12:37:50	1.025,26
1599	2021-06-24 12:34:12	1.025,33	1641	2021-06-24 12:37:52	1.025,26
1600	2021-06-24 12:34:14	1.025,33	1642	2021-06-24 12:37:54	1.025,26
1601	2021-06-24 12:34:16	1.025,33	1643	2021-06-24 12:37:56	1.025,26
1602	2021-06-24 12:34:33	1.025,33	1644	2021-06-24 12:37:58	1.025,26
1603	2021-06-24 12:34:35	1.025,33	1645	2021-06-24 12:38:00	1.025,26
1604	2021-06-24 12:34:39	1.025,33	1646	2021-06-24 12:38:02	1.025,26
1605	2021-06-24 12:34:41	1.025,33	1647	2021-06-24 12:38:17	1.025,16
1606	2021-06-24 12:34:43	1.025,33	1648	2021-06-24 12:38:21	1.025,16
1607	2021-06-24 12:34:45	1.025,33	1649	2021-06-24 12:38:23	1.025,16
1608	2021-06-24 12:34:49	1.025,33	1650	2021-06-24 12:38:25	1.025,16
1609	2021-06-24 12:34:59	1.025,33	1651	2021-06-24 12:38:27	1.025,16
1610	2021-06-24 12:35:01	1.025,33	1652	2021-06-24 12:38:29	1.025,16
1611	2021-06-24 12:35:03	1.025,33	1653	2021-06-24 12:38:31	1.025,16
1612	2021-06-24 12:35:20	1.025,26	1654	2021-06-24 12:38:33	1.025,16
1613	2021-06-24 12:35:22	1.025,26	1655	2021-06-24 12:38:43	1.025,16
1614	2021-06-24 12:35:24	1.025,26	1656	2021-06-24 12:38:45	1.025,16
1615	2021-06-24 12:35:32	1.025,26	1657	2021-06-24 12:38:47	1.025,16
1616	2021-06-24 12:35:34	1.025,26	1658	2021-06-24 12:38:49	1.025,16
1617	2021-06-24 12:35:36	1.025,26	1659	2021-06-24 12:38:55	1.025,16
1618	2021-06-24 12:35:38	1.025,26	1660	2021-06-24 12:38:57	1.025,16
1619	2021-06-24 12:36:10	1.025,30	1661	2021-06-24 12:38:59	1.025,16
1620	2021-06-24 12:36:12	1.025,30	1662	2021-06-24 12:39:01	1.025,16
1621	2021-06-24 12:36:14	1.025,30	1663	2021-06-24 12:39:03	1.025,16
1622	2021-06-24 12:36:16	1.025,30	1664	2021-06-24 12:39:05	1.025,16
1623	2021-06-24 12:36:18	1.025,30	1665	2021-06-24 12:39:07	1.025,16
1624	2021-06-24 12:36:26	1.025,30	1666	2021-06-24 12:39:09	1.025,16
1625	2021-06-24 12:36:41	1.025,30	1667	2021-06-24 12:39:11	1.025,16
1626	2021-06-24 12:36:43	1.025,30	1668	2021-06-24 12:39:13	1.025,16
1627	2021-06-24 12:36:45	1.025,30	1669	2021-06-24 12:39:31	1.025,16
1628	2021-06-24 12:36:47	1.025,30	1670	2021-06-24 12:39:33	1.025,16
1629	2021-06-24 12:36:53	1.025,30	1671	2021-06-24 12:39:40	1.025,16
1630	2021-06-24 12:37:09	1.025,26	1672	2021-06-24 12:39:42	1.025,16
1631	2021-06-24 12:37:11	1.025,26	1673	2021-06-24 12:39:44	1.025,16

1674	2021-06-24 12:39:46	1.025,16	1716	2021-06-24 12:43:05	1.025,13
1675	2021-06-24 12:39:48	1.025,16	1717	2021-06-24 12:43:07	1.025,13
1676	2021-06-24 12:39:50	1.025,16	1718	2021-06-24 12:43:19	1.025,06
1677	2021-06-24 12:39:52	1.025,16	1719	2021-06-24 12:43:25	1.025,06
1678	2021-06-24 12:39:54	1.025,16	1720	2021-06-24 12:43:27	1.025,06
1679	2021-06-24 12:39:56	1.025,16	1721	2021-06-24 12:43:29	1.025,06
1680	2021-06-24 12:39:58	1.025,16	1722	2021-06-24 12:43:31	1.025,06
1681	2021-06-24 12:40:00	1.025,16	1723	2021-06-24 12:43:33	1.025,06
1682	2021-06-24 12:40:02	1.025,16	1724	2021-06-24 12:43:39	1.025,06
1683	2021-06-24 12:40:04	1.025,16	1725	2021-06-24 12:43:41	1.025,06
1684	2021-06-24 12:40:06	1.025,16	1726	2021-06-24 12:43:53	1.025,06
1685	2021-06-24 12:40:36	1.025,20	1727	2021-06-24 12:43:55	1.025,06
1686	2021-06-24 12:40:38	1.025,20	1728	2021-06-24 12:44:01	1.025,06
1687	2021-06-24 12:40:40	1.025,20	1729	2021-06-24 12:44:03	1.025,06
1688	2021-06-24 12:40:42	1.025,20	1730	2021-06-24 12:44:10	1.025,09
1689	2021-06-24 12:40:44	1.025,20	1731	2021-06-24 12:44:12	1.025,09
1690	2021-06-24 12:40:46	1.025,20	1732	2021-06-24 12:44:14	1.025,09
1691	2021-06-24 12:40:48	1.025,20	1733	2021-06-24 12:44:16	1.025,09
1692	2021-06-24 12:40:50	1.025,20	1734	2021-06-24 12:44:20	1.025,09
1693	2021-06-24 12:40:52	1.025,20	1735	2021-06-24 12:44:46	1.025,09
1694	2021-06-24 12:40:54	1.025,20	1736	2021-06-24 12:44:55	1.025,09
1695	2021-06-24 12:40:56	1.025,20	1737	2021-06-24 12:44:57	1.025,09
1696	2021-06-24 12:40:58	1.025,20	1738	2021-06-24 12:44:59	1.025,09
1697	2021-06-24 12:41:00	1.025,20	1739	2021-06-24 12:45:01	1.025,09
1698	2021-06-24 12:41:02	1.025,20	1740	2021-06-24 12:45:03	1.025,09
1699	2021-06-24 12:41:31	1.025,16	1741	2021-06-24 12:45:11	1.025,03
1700	2021-06-24 12:41:33	1.025,16	1742	2021-06-24 12:45:13	1.025,03
1701	2021-06-24 12:41:35	1.025,16	1743	2021-06-24 12:45:17	1.025,03
1702	2021-06-24 12:41:37	1.025,16	1744	2021-06-24 12:45:19	1.025,03
1703	2021-06-24 12:41:39	1.025,16	1745	2021-06-24 12:45:21	1.025,03
1704	2021-06-24 12:41:41	1.025,16	1746	2021-06-24 12:45:23	1.025,03
1705	2021-06-24 12:41:43	1.025,16	1747	2021-06-24 12:45:25	1.025,03
1706	2021-06-24 12:41:45	1.025,16	1748	2021-06-24 12:45:29	1.025,03
1707	2021-06-24 12:41:47	1.025,16	1749	2021-06-24 12:45:31	1.025,03
1708	2021-06-24 12:41:49	1.025,16	1750	2021-06-24 12:46:26	1.025,06
1709	2021-06-24 12:41:56	1.025,16	1751	2021-06-24 12:46:28	1.025,06
1710	2021-06-24 12:41:58	1.025,16	1752	2021-06-24 12:46:54	1.025,06
1711	2021-06-24 12:42:00	1.025,16	1753	2021-06-24 12:46:56	1.025,06
1712	2021-06-24 12:42:02	1.025,16	1754	2021-06-24 12:47:11	1.025,03
1713	2021-06-24 12:42:04	1.025,16	1755	2021-06-24 12:47:13	1.025,03
1714	2021-06-24 12:42:06	1.025,16	1756	2021-06-24 12:47:15	1.025,03
1715	2021-06-24 12:43:03	1.025,13	1757	2021-06-24 12:47:27	1.025,03

1758	2021-06-24 12:47:29	1.025,03	1800	2021-06-24 12:50:37	1.024,99
1759	2021-06-24 12:47:31	1.025,03	1801	2021-06-24 12:50:39	1.024,99
1760	2021-06-24 12:47:39	1.025,03	1802	2021-06-24 12:50:41	1.024,99
1761	2021-06-24 12:48:00	1.025,03	1803	2021-06-24 12:50:43	1.024,99
1762	2021-06-24 12:48:02	1.025,03	1804	2021-06-24 12:50:45	1.024,99
1763	2021-06-24 12:48:04	1.025,03	1805	2021-06-24 12:50:56	1.024,99
1764	2021-06-24 12:48:08	1.025,06	1806	2021-06-24 12:50:58	1.024,99
1765	2021-06-24 12:48:10	1.025,06	1807	2021-06-24 12:51:00	1.024,99
1766	2021-06-24 12:48:12	1.025,06	1808	2021-06-24 12:51:02	1.024,99
1767	2021-06-24 12:48:14	1.025,06	1809	2021-06-24 12:51:04	1.024,99
1768	2021-06-24 12:48:16	1.025,06	1810	2021-06-24 12:51:06	1.024,99
1769	2021-06-24 12:48:18	1.025,06	1811	2021-06-24 12:51:08	1.025,13
1770	2021-06-24 12:48:20	1.025,06	1812	2021-06-24 12:51:10	1.025,13
1771	2021-06-24 12:48:22	1.025,06	1813	2021-06-24 12:51:12	1.025,13
1772	2021-06-24 12:48:24	1.025,06	1814	2021-06-24 12:51:14	1.025,13
1773	2021-06-24 12:48:26	1.025,06	1815	2021-06-24 12:51:16	1.025,13
1774	2021-06-24 12:48:28	1.025,06	1816	2021-06-24 12:51:18	1.025,13
1775	2021-06-24 12:48:30	1.025,06	1817	2021-06-24 12:51:20	1.025,13
1776	2021-06-24 12:48:32	1.025,06	1818	2021-06-24 12:51:22	1.025,13
1777	2021-06-24 12:48:46	1.025,06	1819	2021-06-24 12:51:24	1.025,13
1778	2021-06-24 12:49:04	1.025,06	1820	2021-06-24 12:51:26	1.025,13
1779	2021-06-24 12:49:06	1.025,06	1821	2021-06-24 12:51:30	1.025,13
1780	2021-06-24 12:49:08	1.025,06	1822	2021-06-24 12:51:32	1.025,13
1781	2021-06-24 12:49:10	1.025,06	1823	2021-06-24 12:51:34	1.025,13
1782	2021-06-24 12:49:12	1.025,06	1824	2021-06-24 12:51:41	1.025,13
1783	2021-06-24 12:49:14	1.025,06	1825	2021-06-24 12:51:43	1.025,13
1784	2021-06-24 12:49:16	1.025,06	1826	2021-06-24 12:51:45	1.025,13
1785	2021-06-24 12:49:18	1.025,06	1827	2021-06-24 12:51:47	1.025,13
1786	2021-06-24 12:49:31	1.025,06	1828	2021-06-24 12:51:49	1.025,13
1787	2021-06-24 12:49:33	1.025,06	1829	2021-06-24 12:51:51	1.025,13
1788	2021-06-24 12:49:35	1.025,06	1830	2021-06-24 12:51:53	1.025,13
1789	2021-06-24 12:49:37	1.025,06	1831	2021-06-24 12:51:55	1.025,13
1790	2021-06-24 12:49:39	1.025,06	1832	2021-06-24 12:51:57	1.025,13
1791	2021-06-24 12:49:41	1.025,06	1833	2021-06-24 12:51:59	1.025,13
1792	2021-06-24 12:49:43	1.025,06	1834	2021-06-24 12:52:01	1.025,13
1793	2021-06-24 12:49:45	1.025,06	1835	2021-06-24 12:52:03	1.025,13
1794	2021-06-24 12:49:47	1.025,06	1836	2021-06-24 12:52:05	1.025,13
1795	2021-06-24 12:49:49	1.025,06	1837	2021-06-24 12:52:07	1.025,13
1796	2021-06-24 12:50:23	1.024,99	1838	2021-06-24 12:52:09	1.025,03
1797	2021-06-24 12:50:25	1.024,99	1839	2021-06-24 12:52:11	1.025,03
1798	2021-06-24 12:50:33	1.024,99	1840	2021-06-24 12:52:13	1.025,03
1799	2021-06-24 12:50:35	1.024,99	1841	2021-06-24 12:52:15	1.025,03

1842	2021-06-24 12:52:17	1.025,03	1884	2021-06-24 12:56:41	1.024,99
1843	2021-06-24 12:52:19	1.025,03	1885	2021-06-24 12:56:43	1.024,99
1844	2021-06-24 12:52:50	1.025,03	1886	2021-06-24 12:56:45	1.024,99
1845	2021-06-24 12:53:18	1.025,03	1887	2021-06-24 12:56:49	1.024,99
1846	2021-06-24 12:53:20	1.025,03	1888	2021-06-24 12:56:56	1.024,99
1847	2021-06-24 12:53:26	1.025,03	1889	2021-06-24 12:56:58	1.024,99
1848	2021-06-24 12:53:34	1.025,03	1890	2021-06-24 12:57:08	1.024,92
1849	2021-06-24 12:53:36	1.025,03	1891	2021-06-24 12:57:10	1.024,92
1850	2021-06-24 12:53:40	1.025,03	1892	2021-06-24 12:57:14	1.024,92
1851	2021-06-24 12:53:42	1.025,03	1893	2021-06-24 12:57:22	1.024,92
1852	2021-06-24 12:53:44	1.025,03	1894	2021-06-24 12:57:26	1.024,92
1853	2021-06-24 12:53:46	1.025,03	1895	2021-06-24 12:57:28	1.024,92
1854	2021-06-24 12:53:55	1.025,03	1896	2021-06-24 12:57:30	1.024,92
1855	2021-06-24 12:53:57	1.025,03	1897	2021-06-24 12:57:40	1.024,92
1856	2021-06-24 12:54:17	1.025,06	1898	2021-06-24 12:57:42	1.024,92
1857	2021-06-24 12:54:19	1.025,06	1899	2021-06-24 12:57:44	1.024,92
1858	2021-06-24 12:54:21	1.025,06	1900	2021-06-24 12:57:46	1.024,92
1859	2021-06-24 12:54:23	1.025,06	1901	2021-06-24 12:57:48	1.024,92
1860	2021-06-24 12:54:25	1.025,06	1902	2021-06-24 12:58:08	1.024,86
1861	2021-06-24 12:54:27	1.025,06	1903	2021-06-24 12:58:10	1.024,86
1862	2021-06-24 12:54:29	1.025,06	1904	2021-06-24 12:58:31	1.024,86
1863	2021-06-24 12:54:48	1.025,06	1905	2021-06-24 12:58:33	1.024,86
1864	2021-06-24 12:54:50	1.025,06	1906	2021-06-24 12:58:39	1.024,86
1865	2021-06-24 12:54:52	1.025,06	1907	2021-06-24 12:58:41	1.024,86
1866	2021-06-24 12:54:54	1.025,06	1908	2021-06-24 12:58:43	1.024,86
1867	2021-06-24 12:55:19	1.024,96	1909	2021-06-24 12:58:45	1.024,86
1868	2021-06-24 12:55:36	1.024,96	1910	2021-06-24 12:58:47	1.024,86
1869	2021-06-24 12:55:38	1.024,96	1911	2021-06-24 12:58:49	1.024,86
1870	2021-06-24 12:55:48	1.024,96	1912	2021-06-24 12:58:57	1.024,86
1871	2021-06-24 12:55:50	1.024,96	1913	2021-06-24 12:59:03	1.024,86
1872	2021-06-24 12:55:52	1.024,96	1914	2021-06-24 13:00:10	1.024,82
1873	2021-06-24 12:55:54	1.024,96	1915	2021-06-24 13:00:12	1.024,82
1874	2021-06-24 12:55:56	1.024,96	1916	2021-06-24 13:00:14	1.024,82
1875	2021-06-24 12:56:02	1.024,96	1917	2021-06-24 13:00:16	1.024,82
1876	2021-06-24 12:56:04	1.024,96	1918	2021-06-24 13:00:18	1.024,82
1877	2021-06-24 12:56:11	1.024,99	1919	2021-06-24 13:00:28	1.024,82
1878	2021-06-24 12:56:13	1.024,99	1920	2021-06-24 13:00:30	1.024,82
1879	2021-06-24 12:56:23	1.024,99	1921	2021-06-24 13:00:32	1.024,82
1880	2021-06-24 12:56:25	1.024,99	1922	2021-06-24 13:00:34	1.024,82
1881	2021-06-24 12:56:27	1.024,99	1923	2021-06-24 13:00:41	1.024,82
1882	2021-06-24 12:56:37	1.024,99	1924	2021-06-24 13:00:43	1.024,82
1883	2021-06-24 12:56:39	1.024,99	1925	2021-06-24 13:00:45	1.024,82

1926	2021-06-24 13:00:47	1.024,82
1927	2021-06-24 13:00:49	1.024,82
1928	2021-06-24 13:00:51	1.024,82
1929	2021-06-24 13:00:55	1.024,82
1930	2021-06-24 13:00:57	1.024,82
1931	2021-06-24 13:00:59	1.024,82
1932	2021-06-24 13:01:09	1.024,82
1933	2021-06-24 13:01:11	1.024,82
1934	2021-06-24 13:01:15	1.024,82
1935	2021-06-24 13:01:17	1.024,82
1936	2021-06-24 13:01:19	1.024,82
1937	2021-06-24 13:01:34	1.024,82
1938	2021-06-24 13:01:36	1.024,82
1939	2021-06-24 13:01:58	1.024,82
1940	2021-06-24 13:02:04	1.024,82
1941	2021-06-24 13:03:13	1.024,65
1942	2021-06-24 13:03:19	1.024,65
1943	2021-06-24 13:03:21	1.024,65
1944	2021-06-24 13:03:29	1.024,65
1945	2021-06-24 13:03:51	1.024,65
1946	2021-06-24 13:03:53	1.024,65
1947	2021-06-24 13:03:55	1.024,65
1948	2021-06-24 13:03:57	1.024,65
1949	2021-06-24 13:04:17	1.024,59
1950	2021-06-24 13:04:19	1.024,59
1951	2021-06-24 13:05:35	1.024,65
1952	2021-06-24 13:06:08	1.024,55
1953	2021-06-24 13:06:10	1.024,55
1954	2021-06-24 13:06:12	1.024,55
1955	2021-06-24 13:06:14	1.024,55
1956	2021-06-24 13:06:16	1.024,55
1957	2021-06-24 13:06:18	1.024,55
1958	2021-06-24 13:06:20	1.024,55
1959	2021-06-24 13:06:22	1.024,55
1960	2021-06-24 13:06:24	1.024,55
1961	2021-06-24 13:06:26	1.024,55
1962	2021-06-24 13:06:28	1.024,55
1963	2021-06-24 13:06:30	1.024,55
1964	2021-06-24 13:06:32	1.024,55
1965	2021-06-24 13:06:34	1.024,55
1966	2021-06-24 13:06:51	1.024,55
1967	2021-06-24 13:07:01	1.024,55

1968	2021-06-24 13:07:35	1.024,45
1969	2021-06-24 13:07:37	1.024,45
1970	2021-06-24 13:07:39	1.024,45
1971	2021-06-24 13:07:41	1.024,45
1972	2021-06-24 13:07:43	1.024,45
1973	2021-06-24 13:07:53	1.024,45
1974	2021-06-24 13:07:55	1.024,45
1975	2021-06-24 13:07:57	1.024,45
1976	2021-06-24 13:07:59	1.024,45
1977	2021-06-24 13:08:14	1.024,45
1978	2021-06-24 13:08:16	1.024,45
1979	2021-06-24 13:08:22	1.024,45
1980	2021-06-24 13:08:24	1.024,45
1981	2021-06-24 13:08:26	1.024,45
1982	2021-06-24 13:08:28	1.024,45
1983	2021-06-24 13:08:30	1.024,45
1984	2021-06-24 13:08:32	1.024,45
1985	2021-06-24 13:08:34	1.024,45
1986	2021-06-24 13:08:36	1.024,45
1987	2021-06-24 13:08:40	1.024,45
1988	2021-06-24 13:08:48	1.024,45
1989	2021-06-24 13:09:06	1.024,45
1990	2021-06-24 13:09:08	1.024,45
1991	2021-06-24 13:09:18	1.024,38
1992	2021-06-24 13:09:20	1.024,38
1993	2021-06-24 13:09:22	1.024,38
1994	2021-06-24 13:09:24	1.024,38
1995	2021-06-24 13:09:26	1.024,38
1996	2021-06-24 13:09:28	1.024,38
1997	2021-06-24 13:09:30	1.024,38
1998	2021-06-24 13:09:32	1.024,38
1999	2021-06-24 13:09:41	1.024,38
2000	2021-06-24 13:09:43	1.024,38
2001	2021-06-24 13:09:45	1.024,38
2002	2021-06-24 13:09:47	1.024,38
2003	2021-06-24 13:09:49	1.024,38
2004	2021-06-24 13:09:51	1.024,38
2005	2021-06-24 13:09:55	1.024,38
2006	2021-06-24 13:09:57	1.024,38
2007	2021-06-24 13:09:59	1.024,38
2008	2021-06-24 13:10:01	1.024,38
2009	2021-06-24 13:10:03	1.024,38

2010	2021-06-24 13:10:05	1.024,38	2052	2021-06-24 13:13:50	1.024,48
2011	2021-06-24 13:10:07	1.024,38	2053	2021-06-24 13:13:52	1.024,48
2012	2021-06-24 13:10:19	1.024,32	2054	2021-06-24 13:13:54	1.024,48
2013	2021-06-24 13:10:26	1.024,32	2055	2021-06-24 13:13:56	1.024,48
2014	2021-06-24 13:10:28	1.024,32	2056	2021-06-24 13:14:02	1.024,48
2015	2021-06-24 13:10:30	1.024,32	2057	2021-06-24 13:14:04	1.024,48
2016	2021-06-24 13:10:32	1.024,32	2058	2021-06-24 13:14:19	1.024,48
2017	2021-06-24 13:10:38	1.024,32	2059	2021-06-24 13:14:21	1.024,48
2018	2021-06-24 13:10:40	1.024,32	2060	2021-06-24 13:14:23	1.024,48
2019	2021-06-24 13:10:42	1.024,32	2061	2021-06-24 13:14:25	1.024,48
2020	2021-06-24 13:10:44	1.024,32	2062	2021-06-24 13:14:27	1.024,48
2021	2021-06-24 13:10:46	1.024,32	2063	2021-06-24 13:14:29	1.024,48
2022	2021-06-24 13:10:48	1.024,32	2064	2021-06-24 13:14:31	1.024,48
2023	2021-06-24 13:10:50	1.024,32	2065	2021-06-24 13:14:33	1.024,48
2024	2021-06-24 13:10:52	1.024,32	2066	2021-06-24 13:14:37	1.024,48
2025	2021-06-24 13:12:08	1.024,55	2067	2021-06-24 13:14:39	1.024,48
2026	2021-06-24 13:12:10	1.024,55	2068	2021-06-24 13:14:45	1.024,48
2027	2021-06-24 13:12:12	1.024,55	2069	2021-06-24 13:14:47	1.024,48
2028	2021-06-24 13:12:14	1.024,55	2070	2021-06-24 13:14:49	1.024,48
2029	2021-06-24 13:12:20	1.024,55	2071	2021-06-24 13:14:56	1.024,48
2030	2021-06-24 13:12:22	1.024,55	2072	2021-06-24 13:14:58	1.024,48
2031	2021-06-24 13:12:24	1.024,55	2073	2021-06-24 13:15:00	1.024,48
2032	2021-06-24 13:12:26	1.024,55	2074	2021-06-24 13:15:02	1.024,48
2033	2021-06-24 13:12:28	1.024,55	2075	2021-06-24 13:15:04	1.024,48
2034	2021-06-24 13:12:46	1.024,55	2076	2021-06-24 13:15:06	1.024,48
2035	2021-06-24 13:12:52	1.024,55	2077	2021-06-24 13:15:08	1.024,48
2036	2021-06-24 13:12:54	1.024,55	2078	2021-06-24 13:15:10	1.024,55
2037	2021-06-24 13:12:56	1.024,55	2079	2021-06-24 13:15:24	1.024,55
2038	2021-06-24 13:12:58	1.024,55	2080	2021-06-24 13:15:26	1.024,55
2039	2021-06-24 13:13:00	1.024,55	2081	2021-06-24 13:16:05	1.024,55
2040	2021-06-24 13:13:06	1.024,55	2082	2021-06-24 13:16:13	1.024,48
2041	2021-06-24 13:13:08	1.024,48	2083	2021-06-24 13:16:15	1.024,48
2042	2021-06-24 13:13:12	1.024,48	2084	2021-06-24 13:16:26	1.024,48
2043	2021-06-24 13:13:14	1.024,48	2085	2021-06-24 13:16:28	1.024,48
2044	2021-06-24 13:13:16	1.024,48	2086	2021-06-24 13:16:30	1.024,48
2045	2021-06-24 13:13:26	1.024,48	2087	2021-06-24 13:16:32	1.024,48
2046	2021-06-24 13:13:28	1.024,48	2088	2021-06-24 13:16:34	1.024,48
2047	2021-06-24 13:13:30	1.024,48	2089	2021-06-24 13:16:36	1.024,48
2048	2021-06-24 13:13:32	1.024,48	2090	2021-06-24 13:16:38	1.024,48
2049	2021-06-24 13:13:34	1.024,48	2091	2021-06-24 13:16:40	1.024,48
2050	2021-06-24 13:13:44	1.024,48	2092	2021-06-24 13:16:42	1.024,48
2051	2021-06-24 13:13:46	1.024,48	2093	2021-06-24 13:16:44	1.024,48



2094	2021-06-24 13:16:46	1.024,48	2136	2021-06-24 13:18:55	1.024,48
2095	2021-06-24 13:16:48	1.024,48	2137	2021-06-24 13:18:57	1.024,48
2096	2021-06-24 13:16:50	1.024,48	2138	2021-06-24 13:18:59	1.024,48
2097	2021-06-24 13:16:52	1.024,48	2139	2021-06-24 13:19:01	1.024,48
2098	2021-06-24 13:16:54	1.024,48	2140	2021-06-24 13:19:03	1.024,48
2099	2021-06-24 13:16:56	1.024,48	2141	2021-06-24 13:19:05	1.024,48
2100	2021-06-24 13:17:00	1.024,48	2142	2021-06-24 13:19:07	1.024,48
2101	2021-06-24 13:17:02	1.024,48	2143	2021-06-24 13:19:19	1.024,45
2102	2021-06-24 13:17:04	1.024,48	2144	2021-06-24 13:19:26	1.024,45
2103	2021-06-24 13:17:16	1.024,48	2145	2021-06-24 13:19:28	1.024,45
2104	2021-06-24 13:17:20	1.024,48	2146	2021-06-24 13:19:30	1.024,45
2105	2021-06-24 13:17:22	1.024,48	2147	2021-06-24 13:19:32	1.024,45
2106	2021-06-24 13:17:40	1.024,48	2148	2021-06-24 13:19:34	1.024,45
2107	2021-06-24 13:17:42	1.024,48	2149	2021-06-24 13:19:36	1.024,45
2108	2021-06-24 13:17:44	1.024,48	2150	2021-06-24 13:19:38	1.024,45
2109	2021-06-24 13:17:46	1.024,48	2151	2021-06-24 13:19:40	1.024,45
2110	2021-06-24 13:17:48	1.024,48	2152	2021-06-24 13:19:42	1.024,45
2111	2021-06-24 13:17:55	1.024,48	2153	2021-06-24 13:19:44	1.024,45
2112	2021-06-24 13:17:57	1.024,48	2154	2021-06-24 13:19:46	1.024,45
2113	2021-06-24 13:17:59	1.024,48	2155	2021-06-24 13:19:48	1.024,45
2114	2021-06-24 13:18:01	1.024,48	2156	2021-06-24 13:19:50	1.024,45
2115	2021-06-24 13:18:03	1.024,48	2157	2021-06-24 13:19:52	1.024,45
2116	2021-06-24 13:18:05	1.024,48	2158	2021-06-24 13:19:54	1.024,45
2117	2021-06-24 13:18:07	1.024,48	2159	2021-06-24 13:20:11	1.024,42
2118	2021-06-24 13:18:09	1.024,48	2160	2021-06-24 13:20:13	1.024,42
2119	2021-06-24 13:18:11	1.024,48	2161	2021-06-24 13:20:15	1.024,42
2120	2021-06-24 13:18:13	1.024,48	2162	2021-06-24 13:20:17	1.024,42
2121	2021-06-24 13:18:15	1.024,48	2163	2021-06-24 13:20:19	1.024,42
2122	2021-06-24 13:18:17	1.024,48	2164	2021-06-24 13:20:21	1.024,42
2123	2021-06-24 13:18:20	1.024,48	2165	2021-06-24 13:20:23	1.024,42
2124	2021-06-24 13:18:22	1.024,48	2166	2021-06-24 13:20:25	1.024,42
2125	2021-06-24 13:18:24	1.024,48	2167	2021-06-24 13:20:27	1.024,42
2126	2021-06-24 13:18:26	1.024,48	2168	2021-06-24 13:20:29	1.024,42
2127	2021-06-24 13:18:28	1.024,48	2169	2021-06-24 13:20:31	1.024,42
2128	2021-06-24 13:18:30	1.024,48	2170	2021-06-24 13:20:33	1.024,42
2129	2021-06-24 13:18:32	1.024,48	2171	2021-06-24 13:20:35	1.024,42
2130	2021-06-24 13:18:41	1.024,48	2172	2021-06-24 13:20:37	1.024,42
2131	2021-06-24 13:18:43	1.024,48	2173	2021-06-24 13:20:39	1.024,42
2132	2021-06-24 13:18:45	1.024,48	2174	2021-06-24 13:20:41	1.024,42
2133	2021-06-24 13:18:49	1.024,48	2175	2021-06-24 13:20:43	1.024,42
2134	2021-06-24 13:18:51	1.024,48	2176	2021-06-24 13:20:45	1.024,42
2135	2021-06-24 13:18:53	1.024,48	2177	2021-06-24 13:20:56	1.024,42

2178	2021-06-24 13:20:58	1.024,42	2220	2021-06-24 13:26:21	1.024,45
2179	2021-06-24 13:21:00	1.024,42	2221	2021-06-24 13:27:09	1.024,35
2180	2021-06-24 13:21:02	1.024,42	2222	2021-06-24 13:27:15	1.024,35
2181	2021-06-24 13:21:04	1.024,42	2223	2021-06-24 13:27:17	1.024,35
2182	2021-06-24 13:21:06	1.024,42	2224	2021-06-24 13:27:19	1.024,35
2183	2021-06-24 13:21:08	1.024,38	2225	2021-06-24 13:27:21	1.024,35
2184	2021-06-24 13:21:10	1.024,38	2226	2021-06-24 13:27:23	1.024,35
2185	2021-06-24 13:21:12	1.024,38	2227	2021-06-24 13:27:25	1.024,35
2186	2021-06-24 13:21:14	1.024,38	2228	2021-06-24 13:27:27	1.024,35
2187	2021-06-24 13:21:16	1.024,38	2229	2021-06-24 13:27:31	1.024,35
2188	2021-06-24 13:21:22	1.024,38	2230	2021-06-24 13:27:33	1.024,35
2189	2021-06-24 13:22:09	1.024,42	2231	2021-06-24 13:27:51	1.024,35
2190	2021-06-24 13:22:11	1.024,42	2232	2021-06-24 13:27:53	1.024,35
2191	2021-06-24 13:22:13	1.024,42	2233	2021-06-24 13:27:55	1.024,35
2192	2021-06-24 13:22:15	1.024,42	2234	2021-06-24 13:27:57	1.024,35
2193	2021-06-24 13:22:17	1.024,42	2235	2021-06-24 13:28:03	1.024,35
2194	2021-06-24 13:22:19	1.024,42	2236	2021-06-24 13:28:09	1.024,42
2195	2021-06-24 13:22:39	1.024,42	2237	2021-06-24 13:28:11	1.024,42
2196	2021-06-24 13:23:03	1.024,42	2238	2021-06-24 13:28:15	1.024,42
2197	2021-06-24 13:23:11	1.024,42	2239	2021-06-24 13:28:19	1.024,42
2198	2021-06-24 13:23:13	1.024,42	2240	2021-06-24 13:28:26	1.024,42
2199	2021-06-24 13:23:15	1.024,42	2241	2021-06-24 13:28:28	1.024,42
2200	2021-06-24 13:23:17	1.024,42	2242	2021-06-24 13:28:30	1.024,42
2201	2021-06-24 13:23:19	1.024,42	2243	2021-06-24 13:28:32	1.024,42
2202	2021-06-24 13:23:21	1.024,42	2244	2021-06-24 13:28:34	1.024,42
2203	2021-06-24 13:23:56	1.024,42	2245	2021-06-24 13:28:36	1.024,42
2204	2021-06-24 13:23:58	1.024,42	2246	2021-06-24 13:28:38	1.024,42
2205	2021-06-24 13:24:00	1.024,42	2247	2021-06-24 13:28:40	1.024,42
2206	2021-06-24 13:24:02	1.024,42	2248	2021-06-24 13:28:42	1.024,42
2207	2021-06-24 13:24:04	1.024,42	2249	2021-06-24 13:28:46	1.024,42
2208	2021-06-24 13:24:06	1.024,42	2250	2021-06-24 13:28:48	1.024,42
2209	2021-06-24 13:24:08	1.024,42	2251	2021-06-24 13:28:50	1.024,42
2210	2021-06-24 13:25:15	1.024,52	2252	2021-06-24 13:28:52	1.024,42
2211	2021-06-24 13:25:17	1.024,52	2253	2021-06-24 13:28:54	1.024,42
2212	2021-06-24 13:25:32	1.024,52	2254	2021-06-24 13:28:56	1.024,42
2213	2021-06-24 13:25:34	1.024,52	2255	2021-06-24 13:28:58	1.024,42
2214	2021-06-24 13:25:36	1.024,52	2256	2021-06-24 13:29:02	1.024,42
2215	2021-06-24 13:26:11	1.024,45	2257	2021-06-24 13:29:11	1.024,32
2216	2021-06-24 13:26:13	1.024,45	2258	2021-06-24 13:29:13	1.024,32
2217	2021-06-24 13:26:15	1.024,45	2259	2021-06-24 13:29:15	1.024,32
2218	2021-06-24 13:26:17	1.024,45	2260	2021-06-24 13:29:17	1.024,32
2219	2021-06-24 13:26:19	1.024,45	2261	2021-06-24 13:29:19	1.024,32

2262	2021-06-24 13:29:21	1.024,32	2304	2021-06-24 13:31:35	1.024,35
2263	2021-06-24 13:29:23	1.024,32	2305	2021-06-24 13:31:56	1.024,35
2264	2021-06-24 13:29:25	1.024,32	2306	2021-06-24 13:32:10	1.024,32
2265	2021-06-24 13:29:27	1.024,32	2307	2021-06-24 13:32:12	1.024,32
2266	2021-06-24 13:29:35	1.024,32	2308	2021-06-24 13:32:20	1.024,32
2267	2021-06-24 13:29:37	1.024,32	2309	2021-06-24 13:32:22	1.024,32
2268	2021-06-24 13:29:39	1.024,32	2310	2021-06-24 13:32:24	1.024,32
2269	2021-06-24 13:29:56	1.024,32	2311	2021-06-24 13:32:26	1.024,32
2270	2021-06-24 13:29:58	1.024,32	2312	2021-06-24 13:32:40	1.024,32
2271	2021-06-24 13:30:00	1.024,32	2313	2021-06-24 13:32:48	1.024,32
2272	2021-06-24 13:30:02	1.024,32	2314	2021-06-24 13:32:56	1.024,32
2273	2021-06-24 13:30:04	1.024,32	2315	2021-06-24 13:32:58	1.024,32
2274	2021-06-24 13:30:08	1.024,38	2316	2021-06-24 13:33:00	1.024,32
2275	2021-06-24 13:30:10	1.024,38	2317	2021-06-24 13:33:10	1.024,32
2276	2021-06-24 13:30:14	1.024,38	2318	2021-06-24 13:33:12	1.024,32
2277	2021-06-24 13:30:16	1.024,38	2319	2021-06-24 13:33:24	1.024,32
2278	2021-06-24 13:30:18	1.024,38	2320	2021-06-24 13:33:34	1.024,32
2279	2021-06-24 13:30:20	1.024,38	2321	2021-06-24 13:33:41	1.024,32
2280	2021-06-24 13:30:22	1.024,38	2322	2021-06-24 13:33:43	1.024,32
2281	2021-06-24 13:30:24	1.024,38	2323	2021-06-24 13:33:45	1.024,32
2282	2021-06-24 13:30:26	1.024,38	2324	2021-06-24 13:33:51	1.024,32
2283	2021-06-24 13:30:28	1.024,38	2325	2021-06-24 13:33:53	1.024,32
2284	2021-06-24 13:30:30	1.024,38	2326	2021-06-24 13:33:55	1.024,32
2285	2021-06-24 13:30:34	1.024,38	2327	2021-06-24 13:33:57	1.024,32
2286	2021-06-24 13:30:47	1.024,38	2328	2021-06-24 13:33:59	1.024,32
2287	2021-06-24 13:30:49	1.024,38	2329	2021-06-24 13:34:03	1.024,32
2288	2021-06-24 13:30:53	1.024,38	2330	2021-06-24 13:34:05	1.024,32
2289	2021-06-24 13:30:55	1.024,38	2331	2021-06-24 13:34:07	1.024,32
2290	2021-06-24 13:30:57	1.024,38	2332	2021-06-24 13:34:19	1.024,32
2291	2021-06-24 13:30:59	1.024,38	2333	2021-06-24 13:34:30	1.024,32
2292	2021-06-24 13:31:01	1.024,38	2334	2021-06-24 13:34:32	1.024,32
2293	2021-06-24 13:31:07	1.024,38	2335	2021-06-24 13:34:36	1.024,32
2294	2021-06-24 13:31:11	1.024,35	2336	2021-06-24 13:34:48	1.024,32
2295	2021-06-24 13:31:13	1.024,35	2337	2021-06-24 13:34:50	1.024,32
2296	2021-06-24 13:31:15	1.024,35	2338	2021-06-24 13:34:52	1.024,32
2297	2021-06-24 13:31:17	1.024,35	2339	2021-06-24 13:34:54	1.024,32
2298	2021-06-24 13:31:19	1.024,35	2340	2021-06-24 13:34:58	1.024,32
2299	2021-06-24 13:31:25	1.024,35	2341	2021-06-24 13:35:00	1.024,32
2300	2021-06-24 13:31:27	1.024,35	2342	2021-06-24 13:35:15	1.024,35
2301	2021-06-24 13:31:29	1.024,35	2343	2021-06-24 13:35:17	1.024,35
2302	2021-06-24 13:31:31	1.024,35	2344	2021-06-24 13:35:19	1.024,35
2303	2021-06-24 13:31:33	1.024,35	2345	2021-06-24 13:35:31	1.024,35

2346	2021-06-24 13:35:35	1.024,35	2388	2021-06-24 13:38:39	1.024,32
2347	2021-06-24 13:35:37	1.024,35	2389	2021-06-24 13:39:02	1.024,32
2348	2021-06-24 13:35:41	1.024,35	2390	2021-06-24 13:39:14	1.024,28
2349	2021-06-24 13:35:49	1.024,35	2391	2021-06-24 13:39:16	1.024,28
2350	2021-06-24 13:36:02	1.024,35	2392	2021-06-24 13:39:18	1.024,28
2351	2021-06-24 13:36:04	1.024,35	2393	2021-06-24 13:39:22	1.024,28
2352	2021-06-24 13:36:06	1.024,35	2394	2021-06-24 13:39:24	1.024,28
2353	2021-06-24 13:36:08	1.024,35	2395	2021-06-24 13:39:26	1.024,28
2354	2021-06-24 13:36:10	1.024,35	2396	2021-06-24 13:39:28	1.024,28
2355	2021-06-24 13:36:12	1.024,35	2397	2021-06-24 13:39:41	1.024,28
2356	2021-06-24 13:36:14	1.024,35	2398	2021-06-24 13:39:43	1.024,28
2357	2021-06-24 13:36:44	1.024,35	2399	2021-06-24 13:39:45	1.024,28
2358	2021-06-24 13:36:55	1.024,35	2400	2021-06-24 13:39:47	1.024,28
2359	2021-06-24 13:36:57	1.024,35	2401	2021-06-24 13:39:49	1.024,28
2360	2021-06-24 13:36:59	1.024,35	2402	2021-06-24 13:39:55	1.024,28
2361	2021-06-24 13:37:01	1.024,35	2403	2021-06-24 13:39:59	1.024,28
2362	2021-06-24 13:37:03	1.024,35	2404	2021-06-24 13:40:01	1.024,28
2363	2021-06-24 13:37:09	1.024,32	2405	2021-06-24 13:40:05	1.024,28
2364	2021-06-24 13:37:13	1.024,32	2406	2021-06-24 13:40:07	1.024,28
2365	2021-06-24 13:37:15	1.024,32	2407	2021-06-24 13:40:09	1.024,38
2366	2021-06-24 13:37:17	1.024,32	2408	2021-06-24 13:40:11	1.024,38
2367	2021-06-24 13:37:34	1.024,32	2409	2021-06-24 13:40:30	1.024,38
2368	2021-06-24 13:37:36	1.024,32	2410	2021-06-24 13:40:34	1.024,38
2369	2021-06-24 13:37:38	1.024,32	2411	2021-06-24 13:40:42	1.024,38
2370	2021-06-24 13:37:48	1.024,32	2412	2021-06-24 13:40:44	1.024,38
2371	2021-06-24 13:37:50	1.024,32	2413	2021-06-24 13:40:46	1.024,38
2372	2021-06-24 13:37:52	1.024,32	2414	2021-06-24 13:40:48	1.024,38
2373	2021-06-24 13:37:54	1.024,32	2415	2021-06-24 13:40:50	1.024,38
2374	2021-06-24 13:37:56	1.024,32	2416	2021-06-24 13:40:52	1.024,38
2375	2021-06-24 13:37:58	1.024,32	2417	2021-06-24 13:40:54	1.024,38
2376	2021-06-24 13:38:00	1.024,32	2418	2021-06-24 13:40:56	1.024,38
2377	2021-06-24 13:38:02	1.024,32	2419	2021-06-24 13:40:58	1.024,38
2378	2021-06-24 13:38:04	1.024,32	2420	2021-06-24 13:41:00	1.024,38
2379	2021-06-24 13:38:11	1.024,32	2421	2021-06-24 13:41:10	1.024,35
2380	2021-06-24 13:38:13	1.024,32	2422	2021-06-24 13:41:12	1.024,35
2381	2021-06-24 13:38:15	1.024,32	2423	2021-06-24 13:41:14	1.024,35
2382	2021-06-24 13:38:23	1.024,32	2424	2021-06-24 13:41:16	1.024,35
2383	2021-06-24 13:38:25	1.024,32	2425	2021-06-24 13:41:18	1.024,35
2384	2021-06-24 13:38:27	1.024,32	2426	2021-06-24 13:41:20	1.024,35
2385	2021-06-24 13:38:33	1.024,32	2427	2021-06-24 13:41:22	1.024,35
2386	2021-06-24 13:38:35	1.024,32	2428	2021-06-24 13:41:26	1.024,35
2387	2021-06-24 13:38:37	1.024,32	2429	2021-06-24 13:41:30	1.024,35

2430	2021-06-24 13:41:32	1.024,35	2472	2021-06-24 13:44:13	1.024,21
2431	2021-06-24 13:41:42	1.024,35	2473	2021-06-24 13:44:21	1.024,21
2432	2021-06-24 13:41:44	1.024,35	2474	2021-06-24 13:44:23	1.024,21
2433	2021-06-24 13:41:56	1.024,35	2475	2021-06-24 13:44:25	1.024,21
2434	2021-06-24 13:41:58	1.024,35	2476	2021-06-24 13:44:27	1.024,21
2435	2021-06-24 13:42:00	1.024,35	2477	2021-06-24 13:44:29	1.024,21
2436	2021-06-24 13:42:02	1.024,35	2478	2021-06-24 13:44:39	1.024,21
2437	2021-06-24 13:42:04	1.024,35	2479	2021-06-24 13:44:43	1.024,21
2438	2021-06-24 13:42:06	1.024,35	2480	2021-06-24 13:44:45	1.024,21
2439	2021-06-24 13:42:08	1.024,35	2481	2021-06-24 13:44:56	1.024,21
2440	2021-06-24 13:42:10	1.024,28	2482	2021-06-24 13:44:58	1.024,21
2441	2021-06-24 13:42:12	1.024,28	2483	2021-06-24 13:45:00	1.024,21
2442	2021-06-24 13:42:24	1.024,28	2484	2021-06-24 13:45:02	1.024,21
2443	2021-06-24 13:42:26	1.024,28	2485	2021-06-24 13:45:12	1.024,25
2444	2021-06-24 13:42:28	1.024,28	2486	2021-06-24 13:45:14	1.024,25
2445	2021-06-24 13:42:30	1.024,28	2487	2021-06-24 13:45:16	1.024,25
2446	2021-06-24 13:42:32	1.024,28	2488	2021-06-24 13:45:22	1.024,25
2447	2021-06-24 13:42:34	1.024,28	2489	2021-06-24 13:45:24	1.024,25
2448	2021-06-24 13:42:41	1.024,28	2490	2021-06-24 13:45:26	1.024,25
2449	2021-06-24 13:42:43	1.024,28	2491	2021-06-24 13:45:28	1.024,25
2450	2021-06-24 13:42:45	1.024,28	2492	2021-06-24 13:45:30	1.024,25
2451	2021-06-24 13:42:47	1.024,28	2493	2021-06-24 13:45:32	1.024,25
2452	2021-06-24 13:42:57	1.024,28	2494	2021-06-24 13:45:34	1.024,25
2453	2021-06-24 13:42:59	1.024,28	2495	2021-06-24 13:45:41	1.024,25
2454	2021-06-24 13:43:11	1.024,28	2496	2021-06-24 13:45:43	1.024,25
2455	2021-06-24 13:43:13	1.024,28	2497	2021-06-24 13:46:01	1.024,25
2456	2021-06-24 13:43:26	1.024,28	2498	2021-06-24 13:46:09	1.024,18
2457	2021-06-24 13:43:28	1.024,28	2499	2021-06-24 13:46:11	1.024,18
2458	2021-06-24 13:43:30	1.024,28	2500	2021-06-24 13:46:36	1.024,18
2459	2021-06-24 13:43:32	1.024,28	2501	2021-06-24 13:46:38	1.024,18
2460	2021-06-24 13:43:40	1.024,28	2502	2021-06-24 13:46:42	1.024,18
2461	2021-06-24 13:43:42	1.024,28	2503	2021-06-24 13:46:44	1.024,18
2462	2021-06-24 13:43:44	1.024,28	2504	2021-06-24 13:46:46	1.024,18
2463	2021-06-24 13:43:46	1.024,28	2505	2021-06-24 13:46:56	1.024,18
2464	2021-06-24 13:43:48	1.024,28	2506	2021-06-24 13:47:04	1.024,18
2465	2021-06-24 13:43:50	1.024,28	2507	2021-06-24 13:47:11	1.024,21
2466	2021-06-24 13:43:52	1.024,28	2508	2021-06-24 13:47:13	1.024,21
2467	2021-06-24 13:43:54	1.024,28	2509	2021-06-24 13:47:15	1.024,21
2468	2021-06-24 13:43:56	1.024,28	2510	2021-06-24 13:47:25	1.024,21
2469	2021-06-24 13:44:02	1.024,28	2511	2021-06-24 13:47:27	1.024,21
2470	2021-06-24 13:44:04	1.024,28	2512	2021-06-24 13:47:29	1.024,21
2471	2021-06-24 13:44:11	1.024,21	2513	2021-06-24 13:47:33	1.024,21

2514	2021-06-24 13:47:35	1.024,21	2556	2021-06-24 13:50:35	1.024,15
2515	2021-06-24 13:47:37	1.024,21	2557	2021-06-24 13:50:37	1.024,15
2516	2021-06-24 13:47:39	1.024,21	2558	2021-06-24 13:50:39	1.024,15
2517	2021-06-24 13:47:49	1.024,21	2559	2021-06-24 13:50:43	1.024,15
2518	2021-06-24 13:48:02	1.024,21	2560	2021-06-24 13:50:47	1.024,15
2519	2021-06-24 13:48:04	1.024,21	2561	2021-06-24 13:50:49	1.024,15
2520	2021-06-24 13:48:06	1.024,21	2562	2021-06-24 13:51:02	1.024,15
2521	2021-06-24 13:48:08	1.024,21	2563	2021-06-24 13:51:10	1.024,21
2522	2021-06-24 13:48:10	1.024,18	2564	2021-06-24 13:51:18	1.024,21
2523	2021-06-24 13:48:12	1.024,18	2565	2021-06-24 13:51:20	1.024,21
2524	2021-06-24 13:48:14	1.024,18	2566	2021-06-24 13:51:24	1.024,21
2525	2021-06-24 13:48:16	1.024,18	2567	2021-06-24 13:51:26	1.024,21
2526	2021-06-24 13:48:18	1.024,18	2568	2021-06-24 13:51:30	1.024,21
2527	2021-06-24 13:48:22	1.024,18	2569	2021-06-24 13:51:32	1.024,21
2528	2021-06-24 13:48:24	1.024,18	2570	2021-06-24 13:51:41	1.024,21
2529	2021-06-24 13:48:26	1.024,18	2571	2021-06-24 13:51:43	1.024,21
2530	2021-06-24 13:48:30	1.024,18	2572	2021-06-24 13:51:45	1.024,21
2531	2021-06-24 13:48:32	1.024,18	2573	2021-06-24 13:51:49	1.024,21
2532	2021-06-24 13:48:41	1.024,18	2574	2021-06-24 13:51:51	1.024,21
2533	2021-06-24 13:48:43	1.024,18	2575	2021-06-24 13:51:53	1.024,21
2534	2021-06-24 13:48:45	1.024,18	2576	2021-06-24 13:51:55	1.024,21
2535	2021-06-24 13:48:47	1.024,18	2577	2021-06-24 13:52:03	1.024,21
2536	2021-06-24 13:48:49	1.024,18	2578	2021-06-24 13:52:09	1.024,18
2537	2021-06-24 13:48:51	1.024,18	2579	2021-06-24 13:52:11	1.024,18
2538	2021-06-24 13:48:53	1.024,18	2580	2021-06-24 13:52:15	1.024,18
2539	2021-06-24 13:48:55	1.024,18	2581	2021-06-24 13:52:32	1.024,18
2540	2021-06-24 13:49:07	1.024,18	2582	2021-06-24 13:52:40	1.024,18
2541	2021-06-24 13:49:19	1.024,21	2583	2021-06-24 13:52:42	1.024,18
2542	2021-06-24 13:49:26	1.024,21	2584	2021-06-24 13:52:50	1.024,18
2543	2021-06-24 13:49:28	1.024,21	2585	2021-06-24 13:52:54	1.024,18
2544	2021-06-24 13:49:30	1.024,21	2586	2021-06-24 13:53:11	1.024,15
2545	2021-06-24 13:49:38	1.024,21	2587	2021-06-24 13:53:13	1.024,15
2546	2021-06-24 13:49:40	1.024,21	2588	2021-06-24 13:53:15	1.024,15
2547	2021-06-24 13:49:42	1.024,21	2589	2021-06-24 13:53:21	1.024,15
2548	2021-06-24 13:49:44	1.024,21	2590	2021-06-24 13:53:23	1.024,15
2549	2021-06-24 13:49:46	1.024,21	2591	2021-06-24 13:53:25	1.024,15
2550	2021-06-24 13:49:48	1.024,21	2592	2021-06-24 13:53:27	1.024,15
2551	2021-06-24 13:49:54	1.024,21	2593	2021-06-24 13:53:29	1.024,15
2552	2021-06-24 13:49:56	1.024,21	2594	2021-06-24 13:53:31	1.024,15
2553	2021-06-24 13:50:19	1.024,15	2595	2021-06-24 13:53:33	1.024,15
2554	2021-06-24 13:50:21	1.024,15	2596	2021-06-24 13:53:39	1.024,15
2555	2021-06-24 13:50:27	1.024,15	2597	2021-06-24 13:53:41	1.024,15

2598	2021-06-24 13:53:43	1.024,15	2640	2021-06-24 13:57:02	1.024,21
2599	2021-06-24 13:53:49	1.024,15	2641	2021-06-24 13:57:04	1.024,21
2600	2021-06-24 13:54:02	1.024,15	2642	2021-06-24 13:57:06	1.024,21
2601	2021-06-24 13:54:04	1.024,15	2643	2021-06-24 13:57:16	1.024,18
2602	2021-06-24 13:54:08	1.024,18	2644	2021-06-24 13:57:22	1.024,18
2603	2021-06-24 13:54:10	1.024,18	2645	2021-06-24 13:57:30	1.024,18
2604	2021-06-24 13:54:12	1.024,18	2646	2021-06-24 13:57:32	1.024,18
2605	2021-06-24 13:54:14	1.024,18	2647	2021-06-24 13:57:49	1.024,18
2606	2021-06-24 13:54:16	1.024,18	2648	2021-06-24 13:57:53	1.024,18
2607	2021-06-24 13:54:18	1.024,18	2649	2021-06-24 13:57:59	1.024,18
2608	2021-06-24 13:54:20	1.024,18	2650	2021-06-24 13:58:03	1.024,18
2609	2021-06-24 13:54:32	1.024,18	2651	2021-06-24 13:58:13	1.024,15
2610	2021-06-24 13:54:34	1.024,18	2652	2021-06-24 13:58:15	1.024,15
2611	2021-06-24 13:54:41	1.024,18	2653	2021-06-24 13:58:19	1.024,15
2612	2021-06-24 13:54:43	1.024,18	2654	2021-06-24 13:58:26	1.024,15
2613	2021-06-24 13:54:45	1.024,18	2655	2021-06-24 13:58:28	1.024,15
2614	2021-06-24 13:54:47	1.024,18	2656	2021-06-24 13:58:30	1.024,15
2615	2021-06-24 13:54:49	1.024,18	2657	2021-06-24 13:58:32	1.024,15
2616	2021-06-24 13:54:51	1.024,18	2658	2021-06-24 13:58:34	1.024,15
2617	2021-06-24 13:54:59	1.024,18	2659	2021-06-24 13:58:36	1.024,15
2618	2021-06-24 13:55:01	1.024,18	2660	2021-06-24 13:58:38	1.024,15
2619	2021-06-24 13:55:03	1.024,18	2661	2021-06-24 13:58:50	1.024,15
2620	2021-06-24 13:55:05	1.024,18	2662	2021-06-24 13:58:52	1.024,15
2621	2021-06-24 13:55:09	1.024,15	2663	2021-06-24 13:58:54	1.024,15
2622	2021-06-24 13:55:15	1.024,15	2664	2021-06-24 13:58:58	1.024,15
2623	2021-06-24 13:55:19	1.024,15	2665	2021-06-24 13:59:15	1.024,15
2624	2021-06-24 13:55:27	1.024,15	2666	2021-06-24 13:59:17	1.024,15
2625	2021-06-24 13:55:29	1.024,15	2667	2021-06-24 13:59:19	1.024,15
2626	2021-06-24 13:55:31	1.024,15	2668	2021-06-24 13:59:27	1.024,15
2627	2021-06-24 13:55:35	1.024,15	2669	2021-06-24 13:59:29	1.024,15
2628	2021-06-24 13:55:39	1.024,15	2670	2021-06-24 13:59:31	1.024,15
2629	2021-06-24 13:55:41	1.024,15	2671	2021-06-24 13:59:39	1.024,15
2630	2021-06-24 13:55:45	1.024,15	2672	2021-06-24 13:59:43	1.024,15
2631	2021-06-24 13:55:55	1.024,15	2673	2021-06-24 14:00:02	1.024,15
2632	2021-06-24 13:56:03	1.024,15	2674	2021-06-24 14:00:08	1.024,15
2633	2021-06-24 13:56:05	1.024,15	2675	2021-06-24 14:00:10	1.024,15
2634	2021-06-24 13:56:11	1.024,21	2676	2021-06-24 14:00:12	1.024,15
2635	2021-06-24 13:56:13	1.024,21	2677	2021-06-24 14:00:14	1.024,15
2636	2021-06-24 13:56:19	1.024,21	2678	2021-06-24 14:00:16	1.024,15
2637	2021-06-24 13:56:33	1.024,21	2679	2021-06-24 14:00:20	1.024,15
2638	2021-06-24 13:56:35	1.024,21	2680	2021-06-24 14:00:22	1.024,15
2639	2021-06-24 13:57:00	1.024,21	2681	2021-06-24 14:00:24	1.024,15

2682	2021-06-24 14:00:26	1.024,15	2724	2021-06-24 14:03:22	1.024,21
2683	2021-06-24 14:00:28	1.024,15	2725	2021-06-24 14:03:24	1.024,21
2684	2021-06-24 14:00:30	1.024,15	2726	2021-06-24 14:03:26	1.024,21
2685	2021-06-24 14:00:32	1.024,15	2727	2021-06-24 14:03:30	1.024,21
2686	2021-06-24 14:00:53	1.024,15	2728	2021-06-24 14:03:41	1.024,21
2687	2021-06-24 14:00:55	1.024,15	2729	2021-06-24 14:03:43	1.024,21
2688	2021-06-24 14:00:57	1.024,15	2730	2021-06-24 14:03:45	1.024,21
2689	2021-06-24 14:00:59	1.024,15	2731	2021-06-24 14:03:47	1.024,21
2690	2021-06-24 14:01:01	1.024,15	2732	2021-06-24 14:03:51	1.024,21
2691	2021-06-24 14:01:03	1.024,15	2733	2021-06-24 14:03:53	1.024,21
2692	2021-06-24 14:01:05	1.024,15	2734	2021-06-24 14:03:55	1.024,21
2693	2021-06-24 14:01:07	1.024,15	2735	2021-06-24 14:03:57	1.024,21
2694	2021-06-24 14:01:09	1.024,21	2736	2021-06-24 14:03:59	1.024,21
2695	2021-06-24 14:01:11	1.024,21	2737	2021-06-24 14:04:01	1.024,21
2696	2021-06-24 14:01:13	1.024,21	2738	2021-06-24 14:04:07	1.024,21
2697	2021-06-24 14:01:15	1.024,21	2739	2021-06-24 14:04:40	1.024,11
2698	2021-06-24 14:01:17	1.024,21	2740	2021-06-24 14:04:42	1.024,11
2699	2021-06-24 14:01:36	1.024,21	2741	2021-06-24 14:04:44	1.024,11
2700	2021-06-24 14:01:38	1.024,21	2742	2021-06-24 14:04:46	1.024,11
2701	2021-06-24 14:01:40	1.024,21	2743	2021-06-24 14:04:48	1.024,11
2702	2021-06-24 14:01:42	1.024,21	2744	2021-06-24 14:04:50	1.024,11
2703	2021-06-24 14:01:44	1.024,21	2745	2021-06-24 14:04:54	1.024,11
2704	2021-06-24 14:01:46	1.024,21	2746	2021-06-24 14:05:02	1.024,11
2705	2021-06-24 14:01:48	1.024,21	2747	2021-06-24 14:05:11	1.024,18
2706	2021-06-24 14:01:56	1.024,21	2748	2021-06-24 14:05:13	1.024,18
2707	2021-06-24 14:02:04	1.024,21	2749	2021-06-24 14:05:15	1.024,18
2708	2021-06-24 14:02:23	1.024,11	2750	2021-06-24 14:05:25	1.024,18
2709	2021-06-24 14:02:25	1.024,11	2751	2021-06-24 14:05:27	1.024,18
2710	2021-06-24 14:02:27	1.024,11	2752	2021-06-24 14:05:29	1.024,18
2711	2021-06-24 14:02:35	1.024,11	2753	2021-06-24 14:05:35	1.024,18
2712	2021-06-24 14:02:41	1.024,11	2754	2021-06-24 14:05:43	1.024,18
2713	2021-06-24 14:02:45	1.024,11	2755	2021-06-24 14:05:45	1.024,18
2714	2021-06-24 14:02:47	1.024,11	2756	2021-06-24 14:05:49	1.024,18
2715	2021-06-24 14:02:49	1.024,11	2757	2021-06-24 14:06:02	1.024,18
2716	2021-06-24 14:03:06	1.024,11	2758	2021-06-24 14:06:06	1.024,18
2717	2021-06-24 14:03:08	1.024,11	2759	2021-06-24 14:06:08	1.024,18
2718	2021-06-24 14:03:10	1.024,21	2760	2021-06-24 14:06:10	1.024,18
2719	2021-06-24 14:03:12	1.024,21	2761	2021-06-24 14:06:14	1.024,18
2720	2021-06-24 14:03:14	1.024,21	2762	2021-06-24 14:06:20	1.024,18
2721	2021-06-24 14:03:16	1.024,21	2763	2021-06-24 14:06:22	1.024,18
2722	2021-06-24 14:03:18	1.024,21	2764	2021-06-24 14:06:30	1.024,18
2723	2021-06-24 14:03:20	1.024,21	2765	2021-06-24 14:06:34	1.024,18



2766	2021-06-24 14:06:41	1.024,18	2808	2021-06-24 14:10:01	1.024,11
2767	2021-06-24 14:06:43	1.024,18	2809	2021-06-24 14:10:03	1.024,11
2768	2021-06-24 14:06:45	1.024,18	2810	2021-06-24 14:10:05	1.024,11
2769	2021-06-24 14:06:47	1.024,18	2811	2021-06-24 14:10:11	1.024,21
2770	2021-06-24 14:06:53	1.024,18	2812	2021-06-24 14:10:13	1.024,21
2771	2021-06-24 14:06:55	1.024,18	2813	2021-06-24 14:10:15	1.024,21
2772	2021-06-24 14:07:05	1.024,18	2814	2021-06-24 14:10:17	1.024,21
2773	2021-06-24 14:07:19	1.024,11	2815	2021-06-24 14:10:26	1.024,21
2774	2021-06-24 14:07:25	1.024,11	2816	2021-06-24 14:10:28	1.024,21
2775	2021-06-24 14:07:27	1.024,11	2817	2021-06-24 14:10:36	1.024,21
2776	2021-06-24 14:07:29	1.024,11	2818	2021-06-24 14:10:48	1.024,21
2777	2021-06-24 14:07:31	1.024,11	2819	2021-06-24 14:10:50	1.024,21
2778	2021-06-24 14:07:33	1.024,11	2820	2021-06-24 14:10:54	1.024,21
2779	2021-06-24 14:07:35	1.024,11	2821	2021-06-24 14:10:58	1.024,21
2780	2021-06-24 14:07:37	1.024,11	2822	2021-06-24 14:11:00	1.024,21
2781	2021-06-24 14:07:40	1.024,11	2823	2021-06-24 14:11:04	1.024,21
2782	2021-06-24 14:07:41	1.024,11	2824	2021-06-24 14:11:21	1.024,11
2783	2021-06-24 14:07:44	1.024,11	2825	2021-06-24 14:11:23	1.024,11
2784	2021-06-24 14:07:46	1.024,11	2826	2021-06-24 14:11:25	1.024,11
2785	2021-06-24 14:07:54	1.024,11	2827	2021-06-24 14:11:27	1.024,11
2786	2021-06-24 14:07:56	1.024,11	2828	2021-06-24 14:11:29	1.024,11
2787	2021-06-24 14:08:04	1.024,11	2829	2021-06-24 14:11:31	1.024,11
2788	2021-06-24 14:08:11	1.024,18	2830	2021-06-24 14:11:43	1.024,11
2789	2021-06-24 14:08:13	1.024,18	2831	2021-06-24 14:11:45	1.024,11
2790	2021-06-24 14:08:15	1.024,18	2832	2021-06-24 14:11:47	1.024,11
2791	2021-06-24 14:08:17	1.024,18	2833	2021-06-24 14:11:56	1.024,11
2792	2021-06-24 14:08:19	1.024,18	2834	2021-06-24 14:11:58	1.024,11
2793	2021-06-24 14:08:21	1.024,18	2835	2021-06-24 14:12:06	1.024,11
2794	2021-06-24 14:08:27	1.024,18	2836	2021-06-24 14:12:16	1.024,15
2795	2021-06-24 14:08:29	1.024,18	2837	2021-06-24 14:12:20	1.024,15
2796	2021-06-24 14:08:37	1.024,18	2838	2021-06-24 14:12:22	1.024,15
2797	2021-06-24 14:08:45	1.024,18	2839	2021-06-24 14:12:24	1.024,15
2798	2021-06-24 14:08:47	1.024,18	2840	2021-06-24 14:12:26	1.024,15
2799	2021-06-24 14:09:08	1.024,18	2841	2021-06-24 14:12:34	1.024,15
2800	2021-06-24 14:09:10	1.024,11	2842	2021-06-24 14:12:45	1.024,15
2801	2021-06-24 14:09:12	1.024,11	2843	2021-06-24 14:12:47	1.024,15
2802	2021-06-24 14:09:14	1.024,11	2844	2021-06-24 14:12:49	1.024,15
2803	2021-06-24 14:09:26	1.024,11	2845	2021-06-24 14:12:51	1.024,15
2804	2021-06-24 14:09:34	1.024,11	2846	2021-06-24 14:13:09	1.024,08
2805	2021-06-24 14:09:41	1.024,11	2847	2021-06-24 14:13:11	1.024,08
2806	2021-06-24 14:09:43	1.024,11	2848	2021-06-24 14:13:15	1.024,08
2807	2021-06-24 14:09:59	1.024,11	2849	2021-06-24 14:13:17	1.024,08

2850	2021-06-24 14:13:19	1.024,08	2892	2021-06-24 14:16:58	1.024,04
2851	2021-06-24 14:13:44	1.024,08	2893	2021-06-24 14:17:00	1.024,04
2852	2021-06-24 14:13:46	1.024,08	2894	2021-06-24 14:17:02	1.024,04
2853	2021-06-24 14:13:48	1.024,08	2895	2021-06-24 14:17:04	1.024,04
2854	2021-06-24 14:14:02	1.024,08	2896	2021-06-24 14:17:27	1.024,08
2855	2021-06-24 14:14:04	1.024,08	2897	2021-06-24 14:17:29	1.024,08
2856	2021-06-24 14:14:11	1.024,08	2898	2021-06-24 14:17:31	1.024,08
2857	2021-06-24 14:14:13	1.024,08	2899	2021-06-24 14:17:33	1.024,08
2858	2021-06-24 14:14:15	1.024,08	2900	2021-06-24 14:17:35	1.024,08
2859	2021-06-24 14:14:17	1.024,08	2901	2021-06-24 14:17:37	1.024,08
2860	2021-06-24 14:14:19	1.024,08	2902	2021-06-24 14:18:22	1.024,01
2861	2021-06-24 14:14:21	1.024,08	2903	2021-06-24 14:18:24	1.024,01
2862	2021-06-24 14:14:29	1.024,08	2904	2021-06-24 14:18:26	1.024,01
2863	2021-06-24 14:14:31	1.024,08	2905	2021-06-24 14:18:28	1.024,01
2864	2021-06-24 14:14:33	1.024,08	2906	2021-06-24 14:18:30	1.024,01
2865	2021-06-24 14:14:35	1.024,08	2907	2021-06-24 14:18:32	1.024,01
2866	2021-06-24 14:14:37	1.024,08	2908	2021-06-24 14:18:34	1.024,01
2867	2021-06-24 14:14:39	1.024,08	2909	2021-06-24 14:18:41	1.024,01
2868	2021-06-24 14:14:41	1.024,08	2910	2021-06-24 14:18:43	1.024,01
2869	2021-06-24 14:14:43	1.024,08	2911	2021-06-24 14:18:45	1.024,01
2870	2021-06-24 14:15:00	1.024,08	2912	2021-06-24 14:18:47	1.024,01
2871	2021-06-24 14:15:02	1.024,08	2913	2021-06-24 14:18:51	1.024,01
2872	2021-06-24 14:15:10	1.024,01	2914	2021-06-24 14:18:53	1.024,01
2873	2021-06-24 14:15:12	1.024,01	2915	2021-06-24 14:18:55	1.024,01
2874	2021-06-24 14:15:14	1.024,01	2916	2021-06-24 14:18:59	1.024,01
2875	2021-06-24 14:15:16	1.024,01	2917	2021-06-24 14:19:01	1.024,01
2876	2021-06-24 14:15:41	1.024,01	2918	2021-06-24 14:19:03	1.024,01
2877	2021-06-24 14:15:43	1.024,01	2919	2021-06-24 14:19:05	1.024,01
2878	2021-06-24 14:15:45	1.024,01	2920	2021-06-24 14:19:15	1.024,04
2879	2021-06-24 14:15:47	1.024,01	2921	2021-06-24 14:19:17	1.024,04
2880	2021-06-24 14:15:49	1.024,01	2922	2021-06-24 14:19:19	1.024,04
2881	2021-06-24 14:15:51	1.024,01	2923	2021-06-24 14:19:40	1.024,04
2882	2021-06-24 14:15:53	1.024,01	2924	2021-06-24 14:19:42	1.024,04
2883	2021-06-24 14:15:57	1.024,01	2925	2021-06-24 14:19:44	1.024,04
2884	2021-06-24 14:16:07	1.024,01	2926	2021-06-24 14:19:46	1.024,04
2885	2021-06-24 14:16:09	1.024,04	2927	2021-06-24 14:19:48	1.024,04
2886	2021-06-24 14:16:11	1.024,04	2928	2021-06-24 14:19:50	1.024,04
2887	2021-06-24 14:16:13	1.024,04	2929	2021-06-24 14:19:52	1.024,04
2888	2021-06-24 14:16:15	1.024,04	2930	2021-06-24 14:19:56	1.024,04
2889	2021-06-24 14:16:17	1.024,04	2931	2021-06-24 14:19:58	1.024,04
2890	2021-06-24 14:16:19	1.024,04	2932	2021-06-24 14:20:04	1.024,04
2891	2021-06-24 14:16:56	1.024,04	2933	2021-06-24 14:20:11	1.024,01

2934	2021-06-24 14:20:13	1.024,01	2976	2021-06-24 14:23:25	1.023,98
2935	2021-06-24 14:20:15	1.024,01	2977	2021-06-24 14:23:27	1.023,98
2936	2021-06-24 14:20:17	1.024,01	2978	2021-06-24 14:23:29	1.023,98
2937	2021-06-24 14:20:23	1.024,01	2979	2021-06-24 14:23:33	1.023,98
2938	2021-06-24 14:20:25	1.024,01	2980	2021-06-24 14:23:35	1.023,98
2939	2021-06-24 14:20:29	1.024,01	2981	2021-06-24 14:23:37	1.023,98
2940	2021-06-24 14:20:31	1.024,01	2982	2021-06-24 14:23:43	1.023,98
2941	2021-06-24 14:20:33	1.024,01	2983	2021-06-24 14:23:45	1.023,98
2942	2021-06-24 14:20:35	1.024,01	2984	2021-06-24 14:23:47	1.023,98
2943	2021-06-24 14:20:37	1.024,01	2985	2021-06-24 14:24:02	1.023,98
2944	2021-06-24 14:20:39	1.024,01	2986	2021-06-24 14:24:08	1.023,98
2945	2021-06-24 14:20:47	1.024,01	2987	2021-06-24 14:24:22	1.023,91
2946	2021-06-24 14:20:49	1.024,01	2988	2021-06-24 14:24:24	1.023,91
2947	2021-06-24 14:21:06	1.024,01	2989	2021-06-24 14:24:26	1.023,91
2948	2021-06-24 14:21:08	1.024,01	2990	2021-06-24 14:24:28	1.023,91
2949	2021-06-24 14:21:10	1.024,01	2991	2021-06-24 14:24:30	1.023,91
2950	2021-06-24 14:21:16	1.024,01	2992	2021-06-24 14:24:32	1.023,91
2951	2021-06-24 14:21:26	1.024,01	2993	2021-06-24 14:24:34	1.023,91
2952	2021-06-24 14:21:28	1.024,01	2994	2021-06-24 14:24:47	1.023,91
2953	2021-06-24 14:21:30	1.024,01	2995	2021-06-24 14:24:49	1.023,91
2954	2021-06-24 14:21:32	1.024,01	2996	2021-06-24 14:24:51	1.023,91
2955	2021-06-24 14:21:45	1.024,01	2997	2021-06-24 14:24:53	1.023,91
2956	2021-06-24 14:21:47	1.024,01	2998	2021-06-24 14:24:57	1.023,91
2957	2021-06-24 14:21:59	1.024,01	2999	2021-06-24 14:24:59	1.023,91
2958	2021-06-24 14:22:01	1.024,01	3000	2021-06-24 14:25:01	1.023,91
2959	2021-06-24 14:22:07	1.024,01	3001	2021-06-24 14:25:03	1.023,91
2960	2021-06-24 14:22:11	1.023,94	3002	2021-06-24 14:25:05	1.023,91
2961	2021-06-24 14:22:26	1.023,94	3003	2021-06-24 14:25:07	1.023,91
2962	2021-06-24 14:22:28	1.023,94	3004	2021-06-24 14:25:09	1.023,98
2963	2021-06-24 14:22:30	1.023,94	3005	2021-06-24 14:25:11	1.023,98
2964	2021-06-24 14:22:40	1.023,94	3006	2021-06-24 14:25:15	1.023,98
2965	2021-06-24 14:22:46	1.023,94	3007	2021-06-24 14:25:17	1.023,98
2966	2021-06-24 14:22:48	1.023,94	3008	2021-06-24 14:25:19	1.023,98
2967	2021-06-24 14:22:54	1.023,94	3009	2021-06-24 14:25:30	1.023,98
2968	2021-06-24 14:22:56	1.023,94	3010	2021-06-24 14:25:32	1.023,98
2969	2021-06-24 14:23:00	1.023,94	3011	2021-06-24 14:25:34	1.023,98
2970	2021-06-24 14:23:02	1.023,94	3012	2021-06-24 14:25:36	1.023,98
2971	2021-06-24 14:23:04	1.023,94	3013	2021-06-24 14:25:40	1.023,98
2972	2021-06-24 14:23:11	1.023,98	3014	2021-06-24 14:25:42	1.023,98
2973	2021-06-24 14:23:13	1.023,98	3015	2021-06-24 14:25:44	1.023,98
2974	2021-06-24 14:23:17	1.023,98	3016	2021-06-24 14:25:56	1.023,98
2975	2021-06-24 14:23:19	1.023,98	3017	2021-06-24 14:26:11	1.024,01

3018	2021-06-24 14:26:13	1.024,01	3060	2021-06-24 14:29:23	1.023,98
3019	2021-06-24 14:26:15	1.024,01	3061	2021-06-24 14:29:29	1.023,98
3020	2021-06-24 14:26:27	1.024,01	3062	2021-06-24 14:29:31	1.023,98
3021	2021-06-24 14:26:29	1.024,01	3063	2021-06-24 14:29:33	1.023,98
3022	2021-06-24 14:26:31	1.024,01	3064	2021-06-24 14:29:35	1.023,98
3023	2021-06-24 14:26:37	1.024,01	3065	2021-06-24 14:29:39	1.023,98
3024	2021-06-24 14:26:39	1.024,01	3066	2021-06-24 14:29:41	1.023,98
3025	2021-06-24 14:27:04	1.024,01	3067	2021-06-24 14:29:43	1.023,98
3026	2021-06-24 14:27:10	1.023,88	3068	2021-06-24 14:29:56	1.023,98
3027	2021-06-24 14:27:12	1.023,88	3069	2021-06-24 14:29:58	1.023,98
3028	2021-06-24 14:27:14	1.023,88	3070	2021-06-24 14:30:02	1.023,98
3029	2021-06-24 14:27:16	1.023,88	3071	2021-06-24 14:30:06	1.023,98
3030	2021-06-24 14:27:18	1.023,88	3072	2021-06-24 14:30:10	1.023,88
3031	2021-06-24 14:27:20	1.023,88	3073	2021-06-24 14:30:12	1.023,88
3032	2021-06-24 14:27:22	1.023,88	3074	2021-06-24 14:30:22	1.023,88
3033	2021-06-24 14:27:24	1.023,88	3075	2021-06-24 14:30:28	1.023,88
3034	2021-06-24 14:27:26	1.023,88	3076	2021-06-24 14:30:32	1.023,88
3035	2021-06-24 14:27:28	1.023,88	3077	2021-06-24 14:30:34	1.023,88
3036	2021-06-24 14:27:41	1.023,88	3078	2021-06-24 14:30:41	1.023,88
3037	2021-06-24 14:27:43	1.023,88	3079	2021-06-24 14:30:43	1.023,88
3038	2021-06-24 14:27:45	1.023,88	3080	2021-06-24 14:30:45	1.023,88
3039	2021-06-24 14:28:03	1.023,88	3081	2021-06-24 14:30:47	1.023,88
3040	2021-06-24 14:28:07	1.023,88	3082	2021-06-24 14:30:49	1.023,88
3041	2021-06-24 14:28:09	1.023,91	3083	2021-06-24 14:30:51	1.023,88
3042	2021-06-24 14:28:11	1.023,91	3084	2021-06-24 14:30:53	1.023,88
3043	2021-06-24 14:28:15	1.023,91	3085	2021-06-24 14:30:55	1.023,88
3044	2021-06-24 14:28:26	1.023,91	3086	2021-06-24 14:30:59	1.023,88
3045	2021-06-24 14:28:28	1.023,91	3087	2021-06-24 14:31:01	1.023,88
3046	2021-06-24 14:28:30	1.023,91	3088	2021-06-24 14:31:03	1.023,88
3047	2021-06-24 14:28:36	1.023,91	3089	2021-06-24 14:31:09	1.023,91
3048	2021-06-24 14:28:38	1.023,91	3090	2021-06-24 14:31:15	1.023,91
3049	2021-06-24 14:28:42	1.023,91	3091	2021-06-24 14:31:17	1.023,91
3050	2021-06-24 14:28:44	1.023,91	3092	2021-06-24 14:31:19	1.023,91
3051	2021-06-24 14:28:50	1.023,91	3093	2021-06-24 14:31:26	1.023,91
3052	2021-06-24 14:28:54	1.023,91	3094	2021-06-24 14:31:28	1.023,91
3053	2021-06-24 14:28:56	1.023,91	3095	2021-06-24 14:31:30	1.023,91
3054	2021-06-24 14:28:58	1.023,91	3096	2021-06-24 14:31:32	1.023,91
3055	2021-06-24 14:29:00	1.023,91	3097	2021-06-24 14:31:42	1.023,91
3056	2021-06-24 14:29:02	1.023,91	3098	2021-06-24 14:31:46	1.023,91
3057	2021-06-24 14:29:04	1.023,91	3099	2021-06-24 14:31:48	1.023,91
3058	2021-06-24 14:29:19	1.023,98	3100	2021-06-24 14:31:50	1.023,91
3059	2021-06-24 14:29:21	1.023,98	3101	2021-06-24 14:31:52	1.023,91

3102	2021-06-24 14:31:54	1.023,91	3144	2021-06-24 14:34:30	1.023,84
3103	2021-06-24 14:31:56	1.023,91	3145	2021-06-24 14:34:32	1.023,84
3104	2021-06-24 14:31:58	1.023,91	3146	2021-06-24 14:34:34	1.023,84
3105	2021-06-24 14:32:00	1.023,91	3147	2021-06-24 14:34:36	1.023,84
3106	2021-06-24 14:32:02	1.023,91	3148	2021-06-24 14:34:38	1.023,84
3107	2021-06-24 14:32:11	1.023,88	3149	2021-06-24 14:34:40	1.023,84
3108	2021-06-24 14:32:13	1.023,88	3150	2021-06-24 14:34:42	1.023,84
3109	2021-06-24 14:32:15	1.023,88	3151	2021-06-24 14:34:44	1.023,84
3110	2021-06-24 14:32:17	1.023,88	3152	2021-06-24 14:34:54	1.023,84
3111	2021-06-24 14:32:27	1.023,88	3153	2021-06-24 14:35:02	1.023,84
3112	2021-06-24 14:32:29	1.023,88	3154	2021-06-24 14:35:04	1.023,84
3113	2021-06-24 14:32:31	1.023,88	3155	2021-06-24 14:35:17	1.023,91
3114	2021-06-24 14:32:39	1.023,88	3156	2021-06-24 14:35:19	1.023,91
3115	2021-06-24 14:32:41	1.023,88	3157	2021-06-24 14:35:21	1.023,91
3116	2021-06-24 14:32:43	1.023,88	3158	2021-06-24 14:35:23	1.023,91
3117	2021-06-24 14:32:45	1.023,88	3159	2021-06-24 14:35:29	1.023,91
3118	2021-06-24 14:32:47	1.023,88	3160	2021-06-24 14:35:43	1.023,91
3119	2021-06-24 14:32:49	1.023,88	3161	2021-06-24 14:35:45	1.023,91
3120	2021-06-24 14:32:56	1.023,88	3162	2021-06-24 14:36:00	1.023,91
3121	2021-06-24 14:32:58	1.023,88	3163	2021-06-24 14:36:02	1.023,91
3122	2021-06-24 14:33:00	1.023,88	3164	2021-06-24 14:36:04	1.023,91
3123	2021-06-24 14:33:02	1.023,88	3165	2021-06-24 14:36:06	1.023,91
3124	2021-06-24 14:33:04	1.023,88	3166	2021-06-24 14:36:08	1.023,81
3125	2021-06-24 14:33:06	1.023,88	3167	2021-06-24 14:36:10	1.023,81
3126	2021-06-24 14:33:08	1.023,88	3168	2021-06-24 14:36:12	1.023,81
3127	2021-06-24 14:33:14	1.023,88	3169	2021-06-24 14:36:14	1.023,81
3128	2021-06-24 14:33:18	1.023,88	3170	2021-06-24 14:36:16	1.023,81
3129	2021-06-24 14:33:20	1.023,88	3171	2021-06-24 14:37:05	1.023,81
3130	2021-06-24 14:33:22	1.023,88	3172	2021-06-24 14:37:07	1.023,81
3131	2021-06-24 14:33:24	1.023,88	3173	2021-06-24 14:37:09	1.023,81
3132	2021-06-24 14:33:28	1.023,88	3174	2021-06-24 14:37:15	1.023,81
3133	2021-06-24 14:33:30	1.023,88	3175	2021-06-24 14:37:17	1.023,81
3134	2021-06-24 14:33:32	1.023,88	3176	2021-06-24 14:37:26	1.023,81
3135	2021-06-24 14:33:51	1.023,88	3177	2021-06-24 14:37:28	1.023,81
3136	2021-06-24 14:33:53	1.023,88	3178	2021-06-24 14:37:30	1.023,81
3137	2021-06-24 14:33:55	1.023,88	3179	2021-06-24 14:37:38	1.023,81
3138	2021-06-24 14:33:57	1.023,88	3180	2021-06-24 14:37:40	1.023,81
3139	2021-06-24 14:33:59	1.023,88	3181	2021-06-24 14:37:42	1.023,81
3140	2021-06-24 14:34:09	1.023,84	3182	2021-06-24 14:37:44	1.023,81
3141	2021-06-24 14:34:11	1.023,84	3183	2021-06-24 14:37:46	1.023,81
3142	2021-06-24 14:34:26	1.023,84	3184	2021-06-24 14:37:48	1.023,81
3143	2021-06-24 14:34:28	1.023,84	3185	2021-06-24 14:38:00	1.023,81

3186	2021-06-24 14:38:02	1.023,81	3228	2021-06-24 14:40:52	1.023,84
3187	2021-06-24 14:38:04	1.023,81	3229	2021-06-24 14:40:54	1.023,84
3188	2021-06-24 14:38:11	1.023,81	3230	2021-06-24 14:40:56	1.023,84
3189	2021-06-24 14:38:13	1.023,81	3231	2021-06-24 14:40:58	1.023,84
3190	2021-06-24 14:38:15	1.023,81	3232	2021-06-24 14:41:00	1.023,84
3191	2021-06-24 14:38:17	1.023,81	3233	2021-06-24 14:41:02	1.023,84
3192	2021-06-24 14:38:19	1.023,81	3234	2021-06-24 14:41:04	1.023,84
3193	2021-06-24 14:38:21	1.023,81	3235	2021-06-24 14:41:31	1.023,74
3194	2021-06-24 14:38:23	1.023,81	3236	2021-06-24 14:41:33	1.023,74
3195	2021-06-24 14:38:25	1.023,81	3237	2021-06-24 14:41:37	1.023,74
3196	2021-06-24 14:38:27	1.023,81	3238	2021-06-24 14:41:39	1.023,74
3197	2021-06-24 14:38:29	1.023,81	3239	2021-06-24 14:41:41	1.023,74
3198	2021-06-24 14:38:31	1.023,81	3240	2021-06-24 14:41:43	1.023,74
3199	2021-06-24 14:38:33	1.023,81	3241	2021-06-24 14:41:45	1.023,74
3200	2021-06-24 14:38:43	1.023,81	3242	2021-06-24 14:41:47	1.023,74
3201	2021-06-24 14:38:45	1.023,81	3243	2021-06-24 14:41:49	1.023,74
3202	2021-06-24 14:39:00	1.023,81	3244	2021-06-24 14:41:56	1.023,74
3203	2021-06-24 14:39:04	1.023,81	3245	2021-06-24 14:41:58	1.023,74
3204	2021-06-24 14:39:06	1.023,81	3246	2021-06-24 14:42:00	1.023,74
3205	2021-06-24 14:39:08	1.023,81	3247	2021-06-24 14:42:02	1.023,74
3206	2021-06-24 14:39:12	1.023,81	3248	2021-06-24 14:42:04	1.023,74
3207	2021-06-24 14:39:14	1.023,81	3249	2021-06-24 14:42:08	1.023,74
3208	2021-06-24 14:39:18	1.023,81	3250	2021-06-24 14:42:10	1.023,84
3209	2021-06-24 14:39:28	1.023,81	3251	2021-06-24 14:42:14	1.023,84
3210	2021-06-24 14:39:30	1.023,81	3252	2021-06-24 14:42:16	1.023,84
3211	2021-06-24 14:39:32	1.023,81	3253	2021-06-24 14:42:18	1.023,84
3212	2021-06-24 14:39:34	1.023,81	3254	2021-06-24 14:42:20	1.023,84
3213	2021-06-24 14:39:41	1.023,81	3255	2021-06-24 14:42:24	1.023,84
3214	2021-06-24 14:39:43	1.023,81	3256	2021-06-24 14:42:26	1.023,84
3215	2021-06-24 14:39:45	1.023,81	3257	2021-06-24 14:42:28	1.023,84
3216	2021-06-24 14:39:47	1.023,81	3258	2021-06-24 14:42:30	1.023,84
3217	2021-06-24 14:39:55	1.023,81	3259	2021-06-24 14:42:32	1.023,84
3218	2021-06-24 14:40:05	1.023,81	3260	2021-06-24 14:42:47	1.023,84
3219	2021-06-24 14:40:09	1.023,84	3261	2021-06-24 14:42:49	1.023,84
3220	2021-06-24 14:40:11	1.023,84	3262	2021-06-24 14:42:51	1.023,84
3221	2021-06-24 14:40:13	1.023,84	3263	2021-06-24 14:42:53	1.023,84
3222	2021-06-24 14:40:32	1.023,84	3264	2021-06-24 14:42:55	1.023,84
3223	2021-06-24 14:40:38	1.023,84	3265	2021-06-24 14:42:57	1.023,84
3224	2021-06-24 14:40:42	1.023,84	3266	2021-06-24 14:42:59	1.023,84
3225	2021-06-24 14:40:44	1.023,84	3267	2021-06-24 14:43:01	1.023,84
3226	2021-06-24 14:40:46	1.023,84	3268	2021-06-24 14:43:03	1.023,84
3227	2021-06-24 14:40:50	1.023,84	3269	2021-06-24 14:43:05	1.023,84

3270	2021-06-24 14:43:07	1.023,84	3312	2021-06-24 14:46:26	1.023,98
3271	2021-06-24 14:43:09	1.023,84	3313	2021-06-24 14:46:28	1.023,98
3272	2021-06-24 14:43:11	1.023,84	3314	2021-06-24 14:46:30	1.023,98
3273	2021-06-24 14:43:13	1.023,84	3315	2021-06-24 14:46:32	1.023,98
3274	2021-06-24 14:43:19	1.023,84	3316	2021-06-24 14:46:34	1.023,98
3275	2021-06-24 14:43:26	1.023,84	3317	2021-06-24 14:46:36	1.023,98
3276	2021-06-24 14:43:28	1.023,84	3318	2021-06-24 14:46:44	1.023,98
3277	2021-06-24 14:43:30	1.023,84	3319	2021-06-24 14:46:58	1.023,98
3278	2021-06-24 14:43:32	1.023,84	3320	2021-06-24 14:47:00	1.023,98
3279	2021-06-24 14:43:46	1.023,84	3321	2021-06-24 14:47:02	1.023,98
3280	2021-06-24 14:43:56	1.023,84	3322	2021-06-24 14:47:04	1.023,98
3281	2021-06-24 14:43:58	1.023,84	3323	2021-06-24 14:47:11	1.023,98
3282	2021-06-24 14:44:00	1.023,84	3324	2021-06-24 14:47:13	1.023,98
3283	2021-06-24 14:44:15	1.023,81	3325	2021-06-24 14:47:15	1.023,98
3284	2021-06-24 14:44:17	1.023,81	3326	2021-06-24 14:47:17	1.023,98
3285	2021-06-24 14:44:21	1.023,81	3327	2021-06-24 14:47:19	1.023,98
3286	2021-06-24 14:44:23	1.023,81	3328	2021-06-24 14:47:21	1.023,98
3287	2021-06-24 14:44:25	1.023,81	3329	2021-06-24 14:47:29	1.023,98
3288	2021-06-24 14:44:33	1.023,81	3330	2021-06-24 14:47:31	1.023,98
3289	2021-06-24 14:44:35	1.023,81	3331	2021-06-24 14:47:33	1.023,98
3290	2021-06-24 14:44:37	1.023,81	3332	2021-06-24 14:47:43	1.023,98
3291	2021-06-24 14:44:41	1.023,81	3333	2021-06-24 14:47:45	1.023,98
3292	2021-06-24 14:44:43	1.023,81	3334	2021-06-24 14:47:49	1.023,98
3293	2021-06-24 14:44:47	1.023,81	3335	2021-06-24 14:48:28	1.023,91
3294	2021-06-24 14:44:56	1.023,81	3336	2021-06-24 14:48:30	1.023,91
3295	2021-06-24 14:44:58	1.023,81	3337	2021-06-24 14:48:32	1.023,91
3296	2021-06-24 14:45:00	1.023,81	3338	2021-06-24 14:48:41	1.023,91
3297	2021-06-24 14:45:04	1.023,81	3339	2021-06-24 14:48:43	1.023,91
3298	2021-06-24 14:45:22	1.023,94	3340	2021-06-24 14:48:47	1.023,91
3299	2021-06-24 14:45:24	1.023,94	3341	2021-06-24 14:48:49	1.023,91
3300	2021-06-24 14:45:30	1.023,94	3342	2021-06-24 14:48:53	1.023,91
3301	2021-06-24 14:45:41	1.023,94	3343	2021-06-24 14:48:55	1.023,91
3302	2021-06-24 14:45:43	1.023,94	3344	2021-06-24 14:48:57	1.023,91
3303	2021-06-24 14:45:49	1.023,94	3345	2021-06-24 14:48:59	1.023,91
3304	2021-06-24 14:45:53	1.023,94	3346	2021-06-24 14:49:01	1.023,91
3305	2021-06-24 14:46:03	1.023,94	3347	2021-06-24 14:49:03	1.023,91
3306	2021-06-24 14:46:05	1.023,94	3348	2021-06-24 14:49:05	1.023,91
3307	2021-06-24 14:46:07	1.023,94	3349	2021-06-24 14:49:07	1.023,91
3308	2021-06-24 14:46:09	1.023,98	3350	2021-06-24 14:49:09	1.023,91
3309	2021-06-24 14:46:11	1.023,98	3351	2021-06-24 14:49:13	1.023,91
3310	2021-06-24 14:46:13	1.023,98	3352	2021-06-24 14:49:15	1.023,91
3311	2021-06-24 14:46:15	1.023,98	3353	2021-06-24 14:49:17	1.023,91

3354	2021-06-24 14:49:19	1.023,91	3396	2021-06-24 14:52:17	1.023,81
3355	2021-06-24 14:49:26	1.023,91	3397	2021-06-24 14:52:19	1.023,81
3356	2021-06-24 14:49:28	1.023,91	3398	2021-06-24 14:52:26	1.023,81
3357	2021-06-24 14:49:40	1.023,91	3399	2021-06-24 14:52:28	1.023,81
3358	2021-06-24 14:49:42	1.023,91	3400	2021-06-24 14:52:30	1.023,81
3359	2021-06-24 14:49:44	1.023,91	3401	2021-06-24 14:52:34	1.023,81
3360	2021-06-24 14:49:46	1.023,91	3402	2021-06-24 14:52:44	1.023,81
3361	2021-06-24 14:49:48	1.023,91	3403	2021-06-24 14:52:52	1.023,81
3362	2021-06-24 14:50:00	1.023,91	3404	2021-06-24 14:52:54	1.023,81
3363	2021-06-24 14:50:02	1.023,91	3405	2021-06-24 14:52:56	1.023,81
3364	2021-06-24 14:50:11	1.023,88	3406	2021-06-24 14:52:58	1.023,81
3365	2021-06-24 14:50:13	1.023,88	3407	2021-06-24 14:53:04	1.023,81
3366	2021-06-24 14:50:15	1.023,88	3408	2021-06-24 14:53:11	1.023,77
3367	2021-06-24 14:50:17	1.023,88	3409	2021-06-24 14:53:13	1.023,77
3368	2021-06-24 14:50:19	1.023,88	3410	2021-06-24 14:53:15	1.023,77
3369	2021-06-24 14:50:21	1.023,88	3411	2021-06-24 14:53:17	1.023,77
3370	2021-06-24 14:50:23	1.023,88	3412	2021-06-24 14:53:19	1.023,77
3371	2021-06-24 14:50:25	1.023,88	3413	2021-06-24 14:53:29	1.023,77
3372	2021-06-24 14:50:27	1.023,88	3414	2021-06-24 14:53:31	1.023,77
3373	2021-06-24 14:50:29	1.023,88	3415	2021-06-24 14:53:35	1.023,77
3374	2021-06-24 14:50:33	1.023,88	3416	2021-06-24 14:53:49	1.023,77
3375	2021-06-24 14:50:37	1.023,88	3417	2021-06-24 14:53:56	1.023,77
3376	2021-06-24 14:50:39	1.023,88	3418	2021-06-24 14:53:58	1.023,77
3377	2021-06-24 14:50:41	1.023,88	3419	2021-06-24 14:54:00	1.023,77
3378	2021-06-24 14:50:49	1.023,88	3420	2021-06-24 14:54:02	1.023,77
3379	2021-06-24 14:51:04	1.023,88	3421	2021-06-24 14:54:04	1.023,77
3380	2021-06-24 14:51:06	1.023,88	3422	2021-06-24 14:54:06	1.023,77
3381	2021-06-24 14:51:08	1.023,88	3423	2021-06-24 14:54:14	1.023,71
3382	2021-06-24 14:51:14	1.023,88	3424	2021-06-24 14:54:16	1.023,71
3383	2021-06-24 14:51:16	1.023,88	3425	2021-06-24 14:54:18	1.023,71
3384	2021-06-24 14:51:18	1.023,88	3426	2021-06-24 14:54:20	1.023,71
3385	2021-06-24 14:51:20	1.023,88	3427	2021-06-24 14:54:22	1.023,71
3386	2021-06-24 14:51:24	1.023,88	3428	2021-06-24 14:54:24	1.023,71
3387	2021-06-24 14:51:26	1.023,88	3429	2021-06-24 14:54:26	1.023,71
3388	2021-06-24 14:51:30	1.023,88	3430	2021-06-24 14:54:28	1.023,71
3389	2021-06-24 14:51:47	1.023,88	3431	2021-06-24 14:54:32	1.023,71
3390	2021-06-24 14:51:57	1.023,88	3432	2021-06-24 14:54:34	1.023,71
3391	2021-06-24 14:51:59	1.023,88	3433	2021-06-24 14:54:49	1.023,71
3392	2021-06-24 14:52:01	1.023,88	3434	2021-06-24 14:54:51	1.023,71
3393	2021-06-24 14:52:03	1.023,88	3435	2021-06-24 14:54:53	1.023,71
3394	2021-06-24 14:52:05	1.023,88	3436	2021-06-24 14:55:01	1.023,71
3395	2021-06-24 14:52:07	1.023,88	3437	2021-06-24 14:55:03	1.023,71



3438	2021-06-24 14:55:05	1.023,71	3480	2021-06-24 14:58:56	1.023,71
3439	2021-06-24 14:55:15	1.023,67	3481	2021-06-24 14:58:58	1.023,71
3440	2021-06-24 14:55:17	1.023,67	3482	2021-06-24 14:59:00	1.023,71
3441	2021-06-24 14:56:02	1.023,67	3483	2021-06-24 14:59:11	1.023,60
3442	2021-06-24 14:56:19	1.023,74	3484	2021-06-24 14:59:13	1.023,60
3443	2021-06-24 14:56:21	1.023,74	3485	2021-06-24 14:59:15	1.023,60
3444	2021-06-24 14:56:23	1.023,74	3486	2021-06-24 14:59:21	1.023,60
3445	2021-06-24 14:56:25	1.023,74	3487	2021-06-24 14:59:23	1.023,60
3446	2021-06-24 14:56:27	1.023,74	3488	2021-06-24 14:59:25	1.023,60
3447	2021-06-24 14:56:29	1.023,74	3489	2021-06-24 14:59:27	1.023,60
3448	2021-06-24 14:56:31	1.023,74	3490	2021-06-24 14:59:29	1.023,60
3449	2021-06-24 14:56:33	1.023,74	3491	2021-06-24 14:59:31	1.023,60
3450	2021-06-24 14:56:35	1.023,74	3492	2021-06-24 14:59:47	1.023,60
3451	2021-06-24 14:56:37	1.023,74	3493	2021-06-24 14:59:49	1.023,60
3452	2021-06-24 14:56:41	1.023,74	3494	2021-06-24 15:00:04	1.023,60
3453	2021-06-24 14:56:43	1.023,74	3495	2021-06-24 15:00:06	1.023,60
3454	2021-06-24 14:56:49	1.023,74	3496	2021-06-24 15:00:20	1.023,64
3455	2021-06-24 14:57:04	1.023,74	3497	2021-06-24 15:00:22	1.023,64
3456	2021-06-24 14:57:06	1.023,74	3498	2021-06-24 15:00:24	1.023,64
3457	2021-06-24 14:57:08	1.023,74	3499	2021-06-24 15:00:26	1.023,64
3458	2021-06-24 14:57:16	1.023,71	3500	2021-06-24 15:00:32	1.023,64
3459	2021-06-24 14:57:18	1.023,71	3501	2021-06-24 15:00:34	1.023,64
3460	2021-06-24 14:57:20	1.023,71	3502	2021-06-24 15:00:41	1.023,64
3461	2021-06-24 14:57:28	1.023,71	3503	2021-06-24 15:00:43	1.023,64
3462	2021-06-24 14:57:30	1.023,71	3504	2021-06-24 15:00:47	1.023,64
3463	2021-06-24 14:57:34	1.023,71	3505	2021-06-24 15:00:49	1.023,64
3464	2021-06-24 14:57:41	1.023,71	3506	2021-06-24 15:00:57	1.023,64
3465	2021-06-24 14:57:43	1.023,71	3507	2021-06-24 15:00:59	1.023,64
3466	2021-06-24 14:57:49	1.023,71	3508	2021-06-24 15:01:01	1.023,64
3467	2021-06-24 14:57:53	1.023,71	3509	2021-06-24 15:01:15	1.023,60
3468	2021-06-24 14:57:55	1.023,71	3510	2021-06-24 15:01:17	1.023,60
3469	2021-06-24 14:57:57	1.023,71	3511	2021-06-24 15:01:26	1.023,60
3470	2021-06-24 14:58:11	1.023,71	3512	2021-06-24 15:01:28	1.023,60
3471	2021-06-24 14:58:19	1.023,71	3513	2021-06-24 15:01:30	1.023,60
3472	2021-06-24 14:58:30	1.023,71	3514	2021-06-24 15:01:34	1.023,60
3473	2021-06-24 14:58:32	1.023,71	3515	2021-06-24 15:01:36	1.023,60
3474	2021-06-24 14:58:34	1.023,71	3516	2021-06-24 15:01:40	1.023,60
3475	2021-06-24 14:58:38	1.023,71	3517	2021-06-24 15:01:42	1.023,60
3476	2021-06-24 14:58:40	1.023,71	3518	2021-06-24 15:01:44	1.023,60
3477	2021-06-24 14:58:48	1.023,71	3519	2021-06-24 15:01:46	1.023,60
3478	2021-06-24 14:58:50	1.023,71	3520	2021-06-24 15:01:48	1.023,60
3479	2021-06-24 14:58:54	1.023,71	3521	2021-06-24 15:01:50	1.023,60

3522	2021-06-24 15:01:56	1.023,60	3564	2021-06-24 15:04:52	1.023,64
3523	2021-06-24 15:01:58	1.023,60	3565	2021-06-24 15:04:54	1.023,64
3524	2021-06-24 15:02:11	1.023,64	3566	2021-06-24 15:04:56	1.023,64
3525	2021-06-24 15:02:13	1.023,64	3567	2021-06-24 15:05:02	1.023,64
3526	2021-06-24 15:02:15	1.023,64	3568	2021-06-24 15:05:04	1.023,64
3527	2021-06-24 15:02:17	1.023,64	3569	2021-06-24 15:05:19	1.023,60
3528	2021-06-24 15:02:19	1.023,64	3570	2021-06-24 15:05:21	1.023,60
3529	2021-06-24 15:02:21	1.023,64	3571	2021-06-24 15:05:23	1.023,60
3530	2021-06-24 15:02:25	1.023,64	3572	2021-06-24 15:05:35	1.023,60
3531	2021-06-24 15:02:27	1.023,64	3573	2021-06-24 15:05:37	1.023,60
3532	2021-06-24 15:02:29	1.023,64	3574	2021-06-24 15:05:39	1.023,60
3533	2021-06-24 15:02:37	1.023,64	3575	2021-06-24 15:05:41	1.023,60
3534	2021-06-24 15:02:39	1.023,64	3576	2021-06-24 15:05:49	1.023,60
3535	2021-06-24 15:02:41	1.023,64	3577	2021-06-24 15:05:56	1.023,60
3536	2021-06-24 15:02:43	1.023,64	3578	2021-06-24 15:05:58	1.023,60
3537	2021-06-24 15:02:45	1.023,64	3579	2021-06-24 15:06:00	1.023,60
3538	2021-06-24 15:02:47	1.023,64	3580	2021-06-24 15:06:12	1.023,60
3539	2021-06-24 15:02:49	1.023,64	3581	2021-06-24 15:06:14	1.023,60
3540	2021-06-24 15:02:56	1.023,64	3582	2021-06-24 15:06:16	1.023,60
3541	2021-06-24 15:02:58	1.023,64	3583	2021-06-24 15:06:18	1.023,60
3542	2021-06-24 15:03:00	1.023,64	3584	2021-06-24 15:06:22	1.023,60
3543	2021-06-24 15:03:02	1.023,64	3585	2021-06-24 15:06:26	1.023,60
3544	2021-06-24 15:03:04	1.023,64	3586	2021-06-24 15:06:28	1.023,60
3545	2021-06-24 15:03:06	1.023,64	3587	2021-06-24 15:06:30	1.023,60
3546	2021-06-24 15:03:08	1.023,64	3588	2021-06-24 15:06:32	1.023,60
3547	2021-06-24 15:03:12	1.023,64	3589	2021-06-24 15:06:34	1.023,60
3548	2021-06-24 15:03:14	1.023,64	3590	2021-06-24 15:06:41	1.023,60
3549	2021-06-24 15:03:57	1.023,64	3591	2021-06-24 15:06:43	1.023,60
3550	2021-06-24 15:04:05	1.023,64	3592	2021-06-24 15:06:45	1.023,60
3551	2021-06-24 15:04:07	1.023,64	3593	2021-06-24 15:06:57	1.023,60
3552	2021-06-24 15:04:09	1.023,64	3594	2021-06-24 15:06:59	1.023,60
3553	2021-06-24 15:04:11	1.023,64	3595	2021-06-24 15:07:01	1.023,60
3554	2021-06-24 15:04:17	1.023,64	3596	2021-06-24 15:07:03	1.023,60
3555	2021-06-24 15:04:19	1.023,64	3597	2021-06-24 15:07:05	1.023,60
3556	2021-06-24 15:04:26	1.023,64	3598	2021-06-24 15:07:07	1.023,60
3557	2021-06-24 15:04:28	1.023,64	3599	2021-06-24 15:07:09	1.023,50
3558	2021-06-24 15:04:30	1.023,64	3600	2021-06-24 15:07:11	1.023,50
3559	2021-06-24 15:04:32	1.023,64	3601	2021-06-24 15:07:13	1.023,50
3560	2021-06-24 15:04:40	1.023,64	3602	2021-06-24 15:07:17	1.023,50
3561	2021-06-24 15:04:42	1.023,64	3603	2021-06-24 15:07:34	1.023,50
3562	2021-06-24 15:04:48	1.023,64	3604	2021-06-24 15:07:42	1.023,50
3563	2021-06-24 15:04:50	1.023,64	3605	2021-06-24 15:07:46	1.023,50

3606	2021-06-24 15:07:48	1.023,50	3648	2021-06-24 15:10:03	1.023,57
3607	2021-06-24 15:07:50	1.023,50	3649	2021-06-24 15:10:05	1.023,57
3608	2021-06-24 15:07:58	1.023,50	3650	2021-06-24 15:10:09	1.023,50
3609	2021-06-24 15:08:00	1.023,50	3651	2021-06-24 15:10:11	1.023,50
3610	2021-06-24 15:08:02	1.023,50	3652	2021-06-24 15:10:19	1.023,50
3611	2021-06-24 15:08:11	1.023,60	3653	2021-06-24 15:10:26	1.023,50
3612	2021-06-24 15:08:13	1.023,60	3654	2021-06-24 15:10:28	1.023,50
3613	2021-06-24 15:08:15	1.023,60	3655	2021-06-24 15:10:30	1.023,50
3614	2021-06-24 15:08:17	1.023,60	3656	2021-06-24 15:10:32	1.023,50
3615	2021-06-24 15:08:19	1.023,60	3657	2021-06-24 15:10:34	1.023,50
3616	2021-06-24 15:08:21	1.023,60	3658	2021-06-24 15:10:36	1.023,50
3617	2021-06-24 15:08:23	1.023,60	3659	2021-06-24 15:11:04	1.023,50
3618	2021-06-24 15:08:25	1.023,60	3660	2021-06-24 15:11:11	1.023,50
3619	2021-06-24 15:08:27	1.023,60	3661	2021-06-24 15:11:13	1.023,50
3620	2021-06-24 15:08:29	1.023,60	3662	2021-06-24 15:11:15	1.023,50
3621	2021-06-24 15:08:33	1.023,60	3663	2021-06-24 15:11:17	1.023,50
3622	2021-06-24 15:08:35	1.023,60	3664	2021-06-24 15:11:19	1.023,50
3623	2021-06-24 15:08:37	1.023,60	3665	2021-06-24 15:11:21	1.023,50
3624	2021-06-24 15:08:45	1.023,60	3666	2021-06-24 15:11:43	1.023,50
3625	2021-06-24 15:08:47	1.023,60	3667	2021-06-24 15:11:45	1.023,50
3626	2021-06-24 15:08:49	1.023,60	3668	2021-06-24 15:11:47	1.023,50
3627	2021-06-24 15:08:56	1.023,60	3669	2021-06-24 15:11:49	1.023,50
3628	2021-06-24 15:08:58	1.023,60	3670	2021-06-24 15:11:56	1.023,50
3629	2021-06-24 15:09:00	1.023,60	3671	2021-06-24 15:11:58	1.023,50
3630	2021-06-24 15:09:04	1.023,60	3672	2021-06-24 15:12:00	1.023,50
3631	2021-06-24 15:09:06	1.023,60	3673	2021-06-24 15:12:02	1.023,50
3632	2021-06-24 15:09:14	1.023,57	3674	2021-06-24 15:12:04	1.023,50
3633	2021-06-24 15:09:22	1.023,57	3675	2021-06-24 15:12:06	1.023,50
3634	2021-06-24 15:09:26	1.023,57	3676	2021-06-24 15:12:18	1.023,60
3635	2021-06-24 15:09:28	1.023,57	3677	2021-06-24 15:12:20	1.023,60
3636	2021-06-24 15:09:30	1.023,57	3678	2021-06-24 15:12:22	1.023,60
3637	2021-06-24 15:09:41	1.023,57	3679	2021-06-24 15:12:24	1.023,60
3638	2021-06-24 15:09:43	1.023,57	3680	2021-06-24 15:12:26	1.023,60
3639	2021-06-24 15:09:45	1.023,57	3681	2021-06-24 15:12:53	1.023,60
3640	2021-06-24 15:09:47	1.023,57	3682	2021-06-24 15:12:57	1.023,60
3641	2021-06-24 15:09:49	1.023,57	3683	2021-06-24 15:12:59	1.023,60
3642	2021-06-24 15:09:51	1.023,57	3684	2021-06-24 15:13:01	1.023,60
3643	2021-06-24 15:09:53	1.023,57	3685	2021-06-24 15:13:03	1.023,60
3644	2021-06-24 15:09:55	1.023,57	3686	2021-06-24 15:13:13	1.023,60
3645	2021-06-24 15:09:57	1.023,57	3687	2021-06-24 15:13:15	1.023,60
3646	2021-06-24 15:09:59	1.023,57	3688	2021-06-24 15:13:17	1.023,60
3647	2021-06-24 15:10:01	1.023,57	3689	2021-06-24 15:13:19	1.023,60

3690	2021-06-24 15:13:26	1.023,60	3732	2021-06-24 15:15:53	1.023,64
3691	2021-06-24 15:13:28	1.023,60	3733	2021-06-24 15:15:55	1.023,64
3692	2021-06-24 15:13:30	1.023,60	3734	2021-06-24 15:15:57	1.023,64
3693	2021-06-24 15:13:32	1.023,60	3735	2021-06-24 15:16:07	1.023,64
3694	2021-06-24 15:13:34	1.023,60	3736	2021-06-24 15:16:11	1.023,60
3695	2021-06-24 15:13:36	1.023,60	3737	2021-06-24 15:16:15	1.023,60
3696	2021-06-24 15:13:38	1.023,60	3738	2021-06-24 15:16:42	1.023,60
3697	2021-06-24 15:13:40	1.023,60	3739	2021-06-24 15:16:50	1.023,60
3698	2021-06-24 15:13:42	1.023,60	3740	2021-06-24 15:16:58	1.023,60
3699	2021-06-24 15:13:46	1.023,60	3741	2021-06-24 15:17:00	1.023,60
3700	2021-06-24 15:13:48	1.023,60	3742	2021-06-24 15:17:02	1.023,60
3701	2021-06-24 15:13:50	1.023,60	3743	2021-06-24 15:17:04	1.023,60
3702	2021-06-24 15:13:52	1.023,60	3744	2021-06-24 15:17:11	1.023,67
3703	2021-06-24 15:13:56	1.023,60	3745	2021-06-24 15:17:13	1.023,67
3704	2021-06-24 15:14:04	1.023,60	3746	2021-06-24 15:17:15	1.023,67
3705	2021-06-24 15:14:31	1.023,60	3747	2021-06-24 15:17:17	1.023,67
3706	2021-06-24 15:14:37	1.023,60	3748	2021-06-24 15:17:19	1.023,67
3707	2021-06-24 15:14:39	1.023,60	3749	2021-06-24 15:17:21	1.023,67
3708	2021-06-24 15:14:45	1.023,60	3750	2021-06-24 15:17:23	1.023,67
3709	2021-06-24 15:14:47	1.023,60	3751	2021-06-24 15:17:25	1.023,67
3710	2021-06-24 15:14:56	1.023,60	3752	2021-06-24 15:17:27	1.023,67
3711	2021-06-24 15:14:58	1.023,60	3753	2021-06-24 15:17:29	1.023,67
3712	2021-06-24 15:15:00	1.023,60	3754	2021-06-24 15:17:31	1.023,67
3713	2021-06-24 15:15:02	1.023,60	3755	2021-06-24 15:17:33	1.023,67
3714	2021-06-24 15:15:04	1.023,60	3756	2021-06-24 15:17:47	1.023,67
3715	2021-06-24 15:15:06	1.023,60	3757	2021-06-24 15:17:49	1.023,67
3716	2021-06-24 15:15:08	1.023,60	3758	2021-06-24 15:17:56	1.023,67
3717	2021-06-24 15:15:18	1.023,64	3759	2021-06-24 15:17:58	1.023,67
3718	2021-06-24 15:15:20	1.023,64	3760	2021-06-24 15:18:00	1.023,67
3719	2021-06-24 15:15:22	1.023,64	3761	2021-06-24 15:18:02	1.023,67
3720	2021-06-24 15:15:24	1.023,64	3762	2021-06-24 15:18:08	1.023,71
3721	2021-06-24 15:15:26	1.023,64	3763	2021-06-24 15:18:10	1.023,71
3722	2021-06-24 15:15:28	1.023,64	3764	2021-06-24 15:18:12	1.023,71
3723	2021-06-24 15:15:30	1.023,64	3765	2021-06-24 15:18:14	1.023,71
3724	2021-06-24 15:15:32	1.023,64	3766	2021-06-24 15:18:16	1.023,71
3725	2021-06-24 15:15:34	1.023,64	3767	2021-06-24 15:18:18	1.023,71
3726	2021-06-24 15:15:41	1.023,64	3768	2021-06-24 15:18:20	1.023,71
3727	2021-06-24 15:15:43	1.023,64	3769	2021-06-24 15:18:22	1.023,71
3728	2021-06-24 15:15:45	1.023,64	3770	2021-06-24 15:18:28	1.023,71
3729	2021-06-24 15:15:47	1.023,64	3771	2021-06-24 15:18:30	1.023,71
3730	2021-06-24 15:15:49	1.023,64	3772	2021-06-24 15:18:32	1.023,71
3731	2021-06-24 15:15:51	1.023,64	3773	2021-06-24 15:18:34	1.023,71

3774	2021-06-24 15:18:41	1.023,71	3816	2021-06-24 15:21:41	1.023,71
3775	2021-06-24 15:18:43	1.023,71	3817	2021-06-24 15:21:43	1.023,71
3776	2021-06-24 15:18:45	1.023,71	3818	2021-06-24 15:21:45	1.023,71
3777	2021-06-24 15:18:47	1.023,71	3819	2021-06-24 15:21:47	1.023,71
3778	2021-06-24 15:18:49	1.023,71	3820	2021-06-24 15:21:49	1.023,71
3779	2021-06-24 15:18:51	1.023,71	3821	2021-06-24 15:21:53	1.023,71
3780	2021-06-24 15:18:53	1.023,71	3822	2021-06-24 15:21:55	1.023,71
3781	2021-06-24 15:18:55	1.023,71	3823	2021-06-24 15:21:57	1.023,71
3782	2021-06-24 15:18:57	1.023,71	3824	2021-06-24 15:21:59	1.023,71
3783	2021-06-24 15:18:59	1.023,71	3825	2021-06-24 15:22:01	1.023,71
3784	2021-06-24 15:19:01	1.023,71	3826	2021-06-24 15:22:11	1.023,71
3785	2021-06-24 15:19:03	1.023,71	3827	2021-06-24 15:22:13	1.023,71
3786	2021-06-24 15:19:05	1.023,71	3828	2021-06-24 15:22:15	1.023,71
3787	2021-06-24 15:19:07	1.023,71	3829	2021-06-24 15:22:17	1.023,71
3788	2021-06-24 15:20:11	1.023,74	3830	2021-06-24 15:22:19	1.023,71
3789	2021-06-24 15:20:13	1.023,74	3831	2021-06-24 15:22:26	1.023,71
3790	2021-06-24 15:20:15	1.023,74	3832	2021-06-24 15:22:28	1.023,71
3791	2021-06-24 15:20:17	1.023,74	3833	2021-06-24 15:22:30	1.023,71
3792	2021-06-24 15:20:21	1.023,74	3834	2021-06-24 15:22:32	1.023,71
3793	2021-06-24 15:20:23	1.023,74	3835	2021-06-24 15:22:34	1.023,71
3794	2021-06-24 15:20:25	1.023,74	3836	2021-06-24 15:22:36	1.023,71
3795	2021-06-24 15:20:27	1.023,74	3837	2021-06-24 15:22:38	1.023,71
3796	2021-06-24 15:20:29	1.023,74	3838	2021-06-24 15:22:40	1.023,71
3797	2021-06-24 15:20:31	1.023,74	3839	2021-06-24 15:22:44	1.023,71
3798	2021-06-24 15:20:33	1.023,74	3840	2021-06-24 15:22:46	1.023,71
3799	2021-06-24 15:20:35	1.023,74	3841	2021-06-24 15:22:48	1.023,71
3800	2021-06-24 15:20:37	1.023,74	3842	2021-06-24 15:22:50	1.023,71
3801	2021-06-24 15:20:39	1.023,74	3843	2021-06-24 15:22:52	1.023,71
3802	2021-06-24 15:20:41	1.023,74	3844	2021-06-24 15:22:54	1.023,71
3803	2021-06-24 15:20:43	1.023,74	3845	2021-06-24 15:22:56	1.023,71
3804	2021-06-24 15:20:45	1.023,74	3846	2021-06-24 15:22:58	1.023,71
3805	2021-06-24 15:20:47	1.023,74	3847	2021-06-24 15:23:00	1.023,71
3806	2021-06-24 15:20:49	1.023,74	3848	2021-06-24 15:23:02	1.023,71
3807	2021-06-24 15:20:56	1.023,74	3849	2021-06-24 15:23:04	1.023,71
3808	2021-06-24 15:20:58	1.023,74	3850	2021-06-24 15:23:11	1.023,67
3809	2021-06-24 15:21:00	1.023,74	3851	2021-06-24 15:23:13	1.023,67
3810	2021-06-24 15:21:02	1.023,74	3852	2021-06-24 15:23:29	1.023,67
3811	2021-06-24 15:21:04	1.023,74	3853	2021-06-24 15:23:31	1.023,67
3812	2021-06-24 15:21:06	1.023,74	3854	2021-06-24 15:23:33	1.023,67
3813	2021-06-24 15:21:08	1.023,74	3855	2021-06-24 15:23:35	1.023,67
3814	2021-06-24 15:21:32	1.023,71	3856	2021-06-24 15:23:37	1.023,67
3815	2021-06-24 15:21:34	1.023,71	3857	2021-06-24 15:23:39	1.023,67

3858	2021-06-24 15:23:41	1.023,67	3900	2021-06-24 15:28:05	1.023,60
3859	2021-06-24 15:23:43	1.023,67	3901	2021-06-24 15:28:07	1.023,60
3860	2021-06-24 15:23:45	1.023,67	3902	2021-06-24 15:29:11	1.023,57
3861	2021-06-24 15:23:47	1.023,67	3903	2021-06-24 15:29:13	1.023,57
3862	2021-06-24 15:23:49	1.023,67	3904	2021-06-24 15:29:15	1.023,57
3863	2021-06-24 15:24:00	1.023,67	3905	2021-06-24 15:29:17	1.023,57
3864	2021-06-24 15:24:02	1.023,67	3906	2021-06-24 15:29:19	1.023,57
3865	2021-06-24 15:24:04	1.023,67	3907	2021-06-24 15:29:21	1.023,57
3866	2021-06-24 15:24:06	1.023,67	3908	2021-06-24 15:29:23	1.023,57
3867	2021-06-24 15:24:24	1.023,71	3909	2021-06-24 15:29:25	1.023,57
3868	2021-06-24 15:24:28	1.023,71	3910	2021-06-24 15:29:27	1.023,57
3869	2021-06-24 15:24:30	1.023,71	3911	2021-06-24 15:29:29	1.023,57
3870	2021-06-24 15:24:32	1.023,71	3912	2021-06-24 15:29:31	1.023,57
3871	2021-06-24 15:24:34	1.023,71	3913	2021-06-24 15:29:33	1.023,57
3872	2021-06-24 15:24:41	1.023,71	3914	2021-06-24 15:29:35	1.023,57
3873	2021-06-24 15:24:43	1.023,71	3915	2021-06-24 15:29:37	1.023,57
3874	2021-06-24 15:24:45	1.023,71	3916	2021-06-24 15:29:39	1.023,57
3875	2021-06-24 15:24:55	1.023,71	3917	2021-06-24 15:29:41	1.023,57
3876	2021-06-24 15:25:05	1.023,71	3918	2021-06-24 15:29:43	1.023,57
3877	2021-06-24 15:25:07	1.023,71	3919	2021-06-24 15:29:45	1.023,57
3878	2021-06-24 15:26:33	1.023,60	3920	2021-06-24 15:29:47	1.023,57
3879	2021-06-24 15:26:35	1.023,60	3921	2021-06-24 15:29:49	1.023,57
3880	2021-06-24 15:26:37	1.023,60	3922	2021-06-24 15:29:56	1.023,57
3881	2021-06-24 15:26:39	1.023,60	3923	2021-06-24 15:29:58	1.023,57
3882	2021-06-24 15:26:41	1.023,60	3924	2021-06-24 15:30:00	1.023,57
3883	2021-06-24 15:26:43	1.023,60	3925	2021-06-24 15:30:02	1.023,57
3884	2021-06-24 15:26:45	1.023,60	3926	2021-06-24 15:30:04	1.023,57
3885	2021-06-24 15:26:47	1.023,60	3927	2021-06-24 15:30:06	1.023,57
3886	2021-06-24 15:26:49	1.023,60	3928	2021-06-24 15:30:08	1.023,57
3887	2021-06-24 15:27:14	1.023,60	3929	2021-06-24 15:30:10	1.023,57
3888	2021-06-24 15:27:16	1.023,60	3930	2021-06-24 15:30:12	1.023,57
3889	2021-06-24 15:27:22	1.023,60	3931	2021-06-24 15:30:14	1.023,57
3890	2021-06-24 15:27:24	1.023,60	3932	2021-06-24 15:30:16	1.023,57
3891	2021-06-24 15:27:26	1.023,60	3933	2021-06-24 15:30:18	1.023,57
3892	2021-06-24 15:27:28	1.023,60	3934	2021-06-24 15:30:20	1.023,57
3893	2021-06-24 15:27:30	1.023,60	3935	2021-06-24 15:30:22	1.023,57
3894	2021-06-24 15:27:32	1.023,60	3936	2021-06-24 15:30:24	1.023,57
3895	2021-06-24 15:27:34	1.023,60	3937	2021-06-24 15:30:26	1.023,57
3896	2021-06-24 15:27:57	1.023,60	3938	2021-06-24 15:30:28	1.023,57
3897	2021-06-24 15:27:59	1.023,60	3939	2021-06-24 15:30:30	1.023,57
3898	2021-06-24 15:28:01	1.023,60	3940	2021-06-24 15:30:32	1.023,57
3899	2021-06-24 15:28:03	1.023,60	3941	2021-06-24 15:30:34	1.023,57

3942	2021-06-24 15:30:41	1.023,57
3943	2021-06-24 15:30:43	1.023,57
3944	2021-06-24 15:30:45	1.023,57
3945	2021-06-24 15:30:51	1.023,57
3946	2021-06-24 15:30:53	1.023,57
3947	2021-06-24 15:30:55	1.023,57
3948	2021-06-24 15:30:57	1.023,57
3949	2021-06-24 15:30:59	1.023,57

F.3 REGISTRO DE MEDICIONES DE  
TEMPERATURA AMBIENTE

Promedio		13,86
Ítem	Fecha y hora	Temperatura Ambiente [°C]
1	2021-06-24 10:30:01	10,61
2	2021-06-24 10:30:03	10,61
3	2021-06-24 10:30:05	10,61
4	2021-06-24 10:30:11	10,61
5	2021-06-24 10:30:13	10,61
6	2021-06-24 10:30:15	10,61
7	2021-06-24 10:30:25	10,67
8	2021-06-24 10:30:27	10,67
9	2021-06-24 10:30:29	10,67
10	2021-06-24 10:30:52	10,67
11	2021-06-24 10:30:54	10,67
12	2021-06-24 10:30:56	10,67
13	2021-06-24 10:30:58	10,67
14	2021-06-24 10:31:02	10,67
15	2021-06-24 10:31:04	10,67
16	2021-06-24 10:31:06	10,67
17	2021-06-24 10:31:08	10,67
18	2021-06-24 10:31:18	10,67
19	2021-06-24 10:31:25	10,67
20	2021-06-24 10:31:27	10,67
21	2021-06-24 10:31:29	10,67
22	2021-06-24 10:31:31	10,67
23	2021-06-24 10:31:33	10,67
24	2021-06-24 10:31:35	10,72
25	2021-06-24 10:31:37	10,72
26	2021-06-24 10:31:41	10,72
27	2021-06-24 10:31:43	10,72
28	2021-06-24 10:32:14	10,78
29	2021-06-24 10:32:16	10,78
30	2021-06-24 10:32:18	10,78
31	2021-06-24 10:32:20	10,78
32	2021-06-24 10:32:22	10,78
33	2021-06-24 10:32:24	10,78
34	2021-06-24 10:32:26	10,78
35	2021-06-24 10:32:32	10,78
36	2021-06-24 10:32:44	10,78

37	2021-06-24 10:32:46	10,78
38	2021-06-24 10:32:48	10,78
39	2021-06-24 10:32:55	10,78
40	2021-06-24 10:32:57	10,78
41	2021-06-24 10:32:59	10,78
42	2021-06-24 10:33:01	10,78
43	2021-06-24 10:33:07	10,83
44	2021-06-24 10:33:11	10,83
45	2021-06-24 10:33:13	10,83
46	2021-06-24 10:33:15	10,83
47	2021-06-24 10:33:17	10,83
48	2021-06-24 10:33:19	10,83
49	2021-06-24 10:33:21	10,83
50	2021-06-24 10:33:23	10,83
51	2021-06-24 10:33:27	10,83
52	2021-06-24 10:33:29	10,83
53	2021-06-24 10:33:31	10,83
54	2021-06-24 10:33:33	10,83
55	2021-06-24 10:33:44	10,89
56	2021-06-24 10:33:56	10,94
57	2021-06-24 10:33:58	10,94
58	2021-06-24 10:34:04	10,94
59	2021-06-24 10:34:06	10,94
60	2021-06-24 10:34:08	10,94
61	2021-06-24 10:34:10	10,94
62	2021-06-24 10:34:12	10,94
63	2021-06-24 10:34:35	11,00
64	2021-06-24 10:34:37	10,94
65	2021-06-24 10:34:39	10,94
66	2021-06-24 10:34:41	10,94
67	2021-06-24 10:34:43	10,94
68	2021-06-24 10:34:45	10,94
69	2021-06-24 10:34:47	11,00
70	2021-06-24 10:35:28	11,11
71	2021-06-24 10:35:30	11,11
72	2021-06-24 10:35:32	11,11
73	2021-06-24 10:35:34	11,11
74	2021-06-24 10:36:03	11,11
75	2021-06-24 10:36:13	11,11
76	2021-06-24 10:36:15	11,11
77	2021-06-24 10:36:17	11,11
78	2021-06-24 10:36:19	11,11



79	2021-06-24 10:36:21	11,11
80	2021-06-24 10:36:27	11,11
81	2021-06-24 10:36:29	11,11
82	2021-06-24 10:37:02	11,11
83	2021-06-24 10:37:06	11,11
84	2021-06-24 10:37:12	11,11
85	2021-06-24 10:37:16	11,11
86	2021-06-24 10:37:18	11,11
87	2021-06-24 10:37:25	11,11
88	2021-06-24 10:37:27	11,11
89	2021-06-24 10:37:29	11,11
90	2021-06-24 10:37:33	11,17
91	2021-06-24 10:37:45	11,17
92	2021-06-24 10:37:47	11,17
93	2021-06-24 10:37:49	11,17
94	2021-06-24 10:37:51	11,17
95	2021-06-24 10:37:53	11,11
96	2021-06-24 10:37:55	11,11
97	2021-06-24 10:38:10	11,11
98	2021-06-24 10:38:12	11,11
99	2021-06-24 10:38:14	11,11
100	2021-06-24 10:38:18	11,11
101	2021-06-24 10:38:44	11,17
102	2021-06-24 10:39:03	11,22
103	2021-06-24 10:39:05	11,22
104	2021-06-24 10:39:07	11,22
105	2021-06-24 10:39:09	11,22
106	2021-06-24 10:39:13	11,22
107	2021-06-24 10:39:15	11,22
108	2021-06-24 10:39:19	11,22
109	2021-06-24 10:39:21	11,22
110	2021-06-24 10:39:23	11,22
111	2021-06-24 10:39:25	11,22
112	2021-06-24 10:39:27	11,22
113	2021-06-24 10:39:29	11,22
114	2021-06-24 10:39:31	11,22
115	2021-06-24 10:39:34	11,28
116	2021-06-24 10:39:40	11,28
117	2021-06-24 10:39:42	11,28
118	2021-06-24 10:39:44	11,28
119	2021-06-24 10:39:46	11,22
120	2021-06-24 10:39:48	11,22

121	2021-06-24 10:39:50	11,22
122	2021-06-24 10:39:52	11,22
123	2021-06-24 10:39:54	11,22
124	2021-06-24 10:40:08	11,22
125	2021-06-24 10:40:10	11,22
126	2021-06-24 10:40:12	11,22
127	2021-06-24 10:40:14	11,22
128	2021-06-24 10:40:18	11,28
129	2021-06-24 10:40:25	11,22
130	2021-06-24 10:40:27	11,22
131	2021-06-24 10:40:35	11,22
132	2021-06-24 10:40:43	11,28
133	2021-06-24 10:40:53	11,22
134	2021-06-24 10:40:57	11,22
135	2021-06-24 10:40:59	11,22
136	2021-06-24 10:41:03	11,22
137	2021-06-24 10:41:10	11,28
138	2021-06-24 10:41:12	11,28
139	2021-06-24 10:41:14	11,28
140	2021-06-24 10:41:16	11,28
141	2021-06-24 10:41:18	11,28
142	2021-06-24 10:41:20	11,28
143	2021-06-24 10:41:22	11,28
144	2021-06-24 10:41:24	11,28
145	2021-06-24 10:41:26	11,28
146	2021-06-24 10:41:28	11,33
147	2021-06-24 10:41:30	11,33
148	2021-06-24 10:41:38	11,33
149	2021-06-24 10:41:40	11,33
150	2021-06-24 10:41:42	11,33
151	2021-06-24 10:41:44	11,33
152	2021-06-24 10:41:48	11,33
153	2021-06-24 10:42:17	11,44
154	2021-06-24 10:42:19	11,44
155	2021-06-24 10:42:21	11,44
156	2021-06-24 10:42:23	11,44
157	2021-06-24 10:42:25	11,44
158	2021-06-24 10:42:27	11,44
159	2021-06-24 10:42:29	11,44
160	2021-06-24 10:42:31	11,44
161	2021-06-24 10:42:50	11,56
162	2021-06-24 10:42:52	11,56

163	2021-06-24 10:42:54	11,56
164	2021-06-24 10:42:56	11,56
165	2021-06-24 10:42:58	11,56
166	2021-06-24 10:43:00	11,56
167	2021-06-24 10:43:02	11,56
168	2021-06-24 10:43:04	11,56
169	2021-06-24 10:43:06	11,56
170	2021-06-24 10:43:25	11,61
171	2021-06-24 10:43:27	11,61
172	2021-06-24 10:43:29	11,61
173	2021-06-24 10:43:31	11,61
174	2021-06-24 10:43:33	11,61
175	2021-06-24 10:43:35	11,61
176	2021-06-24 10:43:37	11,61
177	2021-06-24 10:43:45	11,67
178	2021-06-24 10:43:47	11,67
179	2021-06-24 10:43:49	11,67
180	2021-06-24 10:43:53	11,67
181	2021-06-24 10:43:55	11,67
182	2021-06-24 10:43:57	11,67
183	2021-06-24 10:43:59	11,67
184	2021-06-24 10:44:01	11,67
185	2021-06-24 10:44:03	11,67
186	2021-06-24 10:44:14	11,72
187	2021-06-24 10:44:29	11,72
188	2021-06-24 10:44:31	11,72
189	2021-06-24 10:44:32	11,72
190	2021-06-24 10:44:35	11,72
191	2021-06-24 10:44:37	11,72
192	2021-06-24 10:44:39	11,72
193	2021-06-24 10:44:41	11,72
194	2021-06-24 10:44:43	11,78
195	2021-06-24 10:44:55	11,72
196	2021-06-24 10:44:57	11,72
197	2021-06-24 10:44:59	11,72
198	2021-06-24 10:45:01	11,72
199	2021-06-24 10:45:09	11,78
200	2021-06-24 10:45:44	11,83
201	2021-06-24 10:45:54	11,83
202	2021-06-24 10:46:08	11,83
203	2021-06-24 10:46:10	11,83
204	2021-06-24 10:46:12	11,83

205	2021-06-24 10:46:14	11,89
206	2021-06-24 10:46:16	11,89
207	2021-06-24 10:46:25	11,89
208	2021-06-24 10:46:27	11,89
209	2021-06-24 10:46:29	11,89
210	2021-06-24 10:46:33	11,89
211	2021-06-24 10:46:35	11,89
212	2021-06-24 10:46:37	11,89
213	2021-06-24 10:46:39	11,89
214	2021-06-24 10:46:41	11,89
215	2021-06-24 10:46:43	11,89
216	2021-06-24 10:46:45	11,89
217	2021-06-24 10:46:47	11,89
218	2021-06-24 10:46:55	11,89
219	2021-06-24 10:46:59	11,94
220	2021-06-24 10:47:10	11,94
221	2021-06-24 10:47:12	11,94
222	2021-06-24 10:47:14	11,94
223	2021-06-24 10:47:16	11,94
224	2021-06-24 10:47:24	11,94
225	2021-06-24 10:47:26	11,94
226	2021-06-24 10:47:34	11,94
227	24-06-2021 10:47:36	11,94
228	24-06-2021 10:47:38	11,94
229	24-06-2021 10:47:40	11,94
230	24-06-2021 10:47:42	11,94
231	24-06-2021 10:47:44	11,94
232	24-06-2021 10:48:07	11,94
233	24-06-2021 10:48:09	11,94
234	24-06-2021 10:48:11	11,94
235	24-06-2021 10:48:13	12,06
236	24-06-2021 10:48:21	12,06
237	24-06-2021 10:48:23	12,06
238	24-06-2021 10:48:29	12,06
239	24-06-2021 10:48:31	12,06
240	24-06-2021 10:48:33	12,06
241	2021-06-24 10:49:03	12,06
242	2021-06-24 10:49:05	12,06
243	2021-06-24 10:49:15	12,06
244	2021-06-24 10:49:25	12,06
245	2021-06-24 10:49:27	12,06
246	2021-06-24 10:49:29	12,06

247	2021-06-24 10:49:31	12,06
248	2021-06-24 10:49:33	12,06
249	2021-06-24 10:49:35	12,06
250	2021-06-24 10:49:37	12,06
251	2021-06-24 10:49:39	12,06
252	2021-06-24 10:50:10	12,17
253	2021-06-24 10:50:12	12,17
254	2021-06-24 10:50:14	12,17
255	2021-06-24 10:50:16	12,17
256	2021-06-24 10:50:18	12,17
257	2021-06-24 10:50:20	12,11
258	2021-06-24 10:50:22	12,11
259	2021-06-24 10:50:26	12,11
260	2021-06-24 10:50:28	12,11
261	2021-06-24 10:50:30	12,17
262	2021-06-24 10:50:32	12,17
263	2021-06-24 10:50:38	12,17
264	2021-06-24 10:50:40	12,17
265	2021-06-24 10:50:44	12,17
266	2021-06-24 10:50:46	12,17
267	2021-06-24 10:50:48	12,17
268	2021-06-24 10:51:05	12,17
269	2021-06-24 10:51:07	12,17
270	2021-06-24 10:51:09	12,17
271	2021-06-24 10:51:11	12,17
272	2021-06-24 10:51:13	12,17
273	2021-06-24 10:51:15	12,17
274	2021-06-24 10:51:17	12,17
275	2021-06-24 10:51:19	12,17
276	2021-06-24 10:51:23	12,22
277	2021-06-24 10:51:25	12,22
278	2021-06-24 10:51:27	12,22
279	2021-06-24 10:51:29	12,22
280	2021-06-24 10:51:31	12,22
281	2021-06-24 10:51:52	12,22
282	2021-06-24 10:51:54	12,22
283	2021-06-24 10:51:56	12,22
284	2021-06-24 10:51:58	12,22
285	2021-06-24 10:52:00	12,22
286	2021-06-24 10:52:02	12,22
287	2021-06-24 10:52:06	12,22
288	2021-06-24 10:52:25	12,22

289	2021-06-24 10:52:27	12,22
290	2021-06-24 10:52:29	12,22
291	2021-06-24 10:52:31	12,22
292	2021-06-24 10:52:33	12,22
293	2021-06-24 10:52:37	12,22
294	2021-06-24 10:52:39	12,22
295	2021-06-24 10:52:41	12,22
296	2021-06-24 10:52:43	12,22
297	2021-06-24 10:52:45	12,28
298	2021-06-24 10:53:11	12,28
299	2021-06-24 10:53:13	12,28
300	2021-06-24 10:53:15	12,33
301	2021-06-24 10:53:17	12,33
302	2021-06-24 10:53:19	12,33
303	2021-06-24 10:53:21	12,33
304	2021-06-24 10:53:23	12,33
305	2021-06-24 10:53:25	12,33
306	2021-06-24 10:53:27	12,33
307	2021-06-24 10:53:29	12,33
308	2021-06-24 10:53:31	12,33
309	2021-06-24 10:53:33	12,33
310	2021-06-24 10:53:35	12,33
311	2021-06-24 10:53:37	12,33
312	2021-06-24 10:53:39	12,33
313	2021-06-24 10:53:41	12,33
314	2021-06-24 10:53:43	12,33
315	2021-06-24 10:53:45	12,33
316	2021-06-24 10:53:47	12,33
317	2021-06-24 10:53:49	12,33
318	2021-06-24 10:53:56	12,33
319	2021-06-24 10:53:58	12,33
320	2021-06-24 10:54:00	12,33
321	2021-06-24 10:54:02	12,33
322	2021-06-24 10:54:04	12,33
323	2021-06-24 10:54:06	12,39
324	2021-06-24 10:54:24	12,39
325	2021-06-24 10:54:30	12,39
326	2021-06-24 10:54:32	12,39
327	2021-06-24 10:54:34	12,39
328	2021-06-24 10:54:40	12,44
329	2021-06-24 10:54:42	12,44
330	2021-06-24 10:54:50	12,44

331	2021-06-24 10:54:52	12,44
332	2021-06-24 10:54:54	12,44
333	2021-06-24 10:54:56	12,44
334	2021-06-24 10:54:58	12,44
335	2021-06-24 10:55:06	12,44
336	2021-06-24 10:55:08	12,44
337	2021-06-24 10:55:12	12,44
338	2021-06-24 10:55:14	12,44
339	2021-06-24 10:55:16	12,44
340	2021-06-24 10:55:18	12,44
341	2021-06-24 10:55:30	12,50
342	2021-06-24 10:55:32	12,50
343	2021-06-24 10:55:40	12,50
344	2021-06-24 10:55:42	12,50
345	2021-06-24 10:55:58	12,50
346	2021-06-24 10:56:00	12,50
347	2021-06-24 10:56:02	12,50
348	2021-06-24 10:56:10	12,56
349	2021-06-24 10:56:12	12,56
350	2021-06-24 10:56:14	12,56
351	2021-06-24 10:56:16	12,56
352	2021-06-24 10:56:18	12,56
353	2021-06-24 10:56:20	12,56
354	2021-06-24 10:56:22	12,56
355	2021-06-24 10:56:28	12,56
356	2021-06-24 10:56:30	12,56
357	2021-06-24 10:56:32	12,56
358	2021-06-24 10:56:34	12,56
359	2021-06-24 10:56:36	12,56
360	2021-06-24 10:56:38	12,56
361	2021-06-24 10:56:46	12,56
362	2021-06-24 10:56:48	12,56
363	2021-06-24 10:56:55	12,61
364	2021-06-24 10:56:57	12,61
365	2021-06-24 10:56:59	12,61
366	2021-06-24 10:57:07	12,61
367	2021-06-24 10:57:11	12,61
368	2021-06-24 10:57:13	12,61
369	2021-06-24 10:57:15	12,61
370	2021-06-24 10:57:19	12,61
371	2021-06-24 10:57:25	12,61
372	2021-06-24 10:57:33	12,61

373	2021-06-24 10:57:40	12,61
374	2021-06-24 10:57:42	12,61
375	2021-06-24 10:57:44	12,61
376	2021-06-24 10:57:46	12,61
377	2021-06-24 10:57:48	12,61
378	2021-06-24 10:57:52	12,61
379	2021-06-24 10:58:04	12,67
380	2021-06-24 10:58:06	12,67
381	2021-06-24 10:58:08	12,67
382	2021-06-24 10:58:10	12,67
383	2021-06-24 10:58:26	12,67
384	2021-06-24 10:58:28	12,67
385	2021-06-24 10:58:42	12,72
386	2021-06-24 10:58:44	12,72
387	2021-06-24 10:58:46	12,72
388	2021-06-24 10:58:56	12,72
389	2021-06-24 10:58:58	12,72
390	2021-06-24 10:59:00	12,72
391	2021-06-24 10:59:02	12,72
392	2021-06-24 10:59:04	12,72
393	2021-06-24 10:59:14	12,72
394	2021-06-24 10:59:22	12,72
395	2021-06-24 10:59:26	12,78
396	2021-06-24 10:59:28	12,78
397	2021-06-24 10:59:30	12,78
398	2021-06-24 10:59:32	12,78
399	2021-06-24 10:59:34	12,78
400	2021-06-24 10:59:36	12,78
401	2021-06-24 10:59:38	12,78
402	2021-06-24 10:59:40	12,78
403	2021-06-24 10:59:44	12,72
404	2021-06-24 10:59:46	12,72
405	2021-06-24 10:59:48	12,72
406	2021-06-24 10:59:55	12,78
407	2021-06-24 10:59:57	12,78
408	2021-06-24 10:59:59	12,78
409	2021-06-24 11:00:01	12,78
410	2021-06-24 11:00:03	12,78
411	2021-06-24 11:00:05	12,78
412	2021-06-24 11:00:07	12,78
413	2021-06-24 11:00:11	12,78
414	2021-06-24 11:00:27	12,78

415	2021-06-24 11:00:29	12,78
416	2021-06-24 11:00:31	12,78
417	2021-06-24 11:00:33	12,78
418	2021-06-24 11:00:41	12,83
419	2021-06-24 11:00:43	12,83
420	2021-06-24 11:00:45	12,83
421	2021-06-24 11:00:47	12,83
422	2021-06-24 11:00:49	12,83
423	2021-06-24 11:00:51	12,83
424	2021-06-24 11:00:53	12,83
425	2021-06-24 11:00:55	12,83
426	2021-06-24 11:00:57	12,83
427	2021-06-24 11:00:59	12,83
428	2021-06-24 11:01:01	12,83
429	2021-06-24 11:01:03	12,83
430	2021-06-24 11:01:05	12,83
431	2021-06-24 11:01:07	12,83
432	2021-06-24 11:01:09	12,83
433	2021-06-24 11:01:11	12,83
434	2021-06-24 11:01:13	12,83
435	2021-06-24 11:01:15	12,83
436	2021-06-24 11:01:25	12,83
437	2021-06-24 11:01:27	12,83
438	2021-06-24 11:01:29	12,83
439	2021-06-24 11:01:31	12,83
440	2021-06-24 11:01:33	12,83
441	2021-06-24 11:01:35	12,83
442	2021-06-24 11:01:37	12,83
443	2021-06-24 11:01:39	12,89
444	2021-06-24 11:01:43	12,89
445	2021-06-24 11:01:45	12,89
446	2021-06-24 11:01:47	12,89
447	2021-06-24 11:01:49	12,83
448	2021-06-24 11:01:51	12,83
449	2021-06-24 11:01:53	12,83
450	2021-06-24 11:01:55	12,83
451	2021-06-24 11:01:57	12,83
452	2021-06-24 11:01:59	12,89
453	2021-06-24 11:02:01	12,89
454	2021-06-24 11:02:03	12,89
455	2021-06-24 11:02:16	12,89
456	2021-06-24 11:02:18	12,89

457	2021-06-24 11:02:20	12,89
458	2021-06-24 11:02:22	12,89
459	2021-06-24 11:02:24	12,89
460	2021-06-24 11:02:26	12,89
461	2021-06-24 11:02:28	12,89
462	2021-06-24 11:02:30	12,89
463	2021-06-24 11:02:32	12,89
464	2021-06-24 11:02:34	12,89
465	2021-06-24 11:02:36	12,89
466	2021-06-24 11:03:50	13,00
467	2021-06-24 11:04:04	13,00
468	2021-06-24 11:04:06	13,00
469	2021-06-24 11:04:08	13,00
470	2021-06-24 11:04:10	13,00
471	2021-06-24 11:04:12	13,00
472	2021-06-24 11:04:14	13,00
473	2021-06-24 11:04:16	13,00
474	2021-06-24 11:04:18	13,00
475	2021-06-24 11:04:25	13,06
476	2021-06-24 11:04:27	13,06
477	2021-06-24 11:04:29	13,06
478	2021-06-24 11:04:31	13,06
479	2021-06-24 11:04:33	13,06
480	2021-06-24 11:04:35	13,06
481	2021-06-24 11:04:37	13,06
482	2021-06-24 11:04:39	13,06
483	2021-06-24 11:04:41	13,06
484	2021-06-24 11:04:43	13,06
485	2021-06-24 11:04:45	13,06
486	2021-06-24 11:04:47	13,06
487	2021-06-24 11:04:49	13,06
488	2021-06-24 11:04:51	13,06
489	2021-06-24 11:04:53	13,11
490	2021-06-24 11:04:55	13,11
491	2021-06-24 11:04:57	13,11
492	2021-06-24 11:04:59	13,11
493	2021-06-24 11:05:01	13,11
494	2021-06-24 11:05:03	13,06
495	2021-06-24 11:05:36	13,11
496	2021-06-24 11:05:38	13,11
497	2021-06-24 11:05:40	13,11
498	2021-06-24 11:05:42	13,11

499	2021-06-24 11:06:02	13,17
500	2021-06-24 11:06:06	13,17
501	2021-06-24 11:06:12	13,17
502	2021-06-24 11:06:16	13,17
503	2021-06-24 11:06:18	13,17
504	2021-06-24 11:06:20	13,17
505	2021-06-24 11:06:22	13,17
506	2021-06-24 11:06:24	13,22
507	2021-06-24 11:06:26	13,22
508	2021-06-24 11:06:28	13,22
509	2021-06-24 11:07:31	13,22
510	2021-06-24 11:07:33	13,22
511	2021-06-24 11:07:35	13,22
512	2021-06-24 11:07:37	13,22
513	2021-06-24 11:07:49	13,22
514	2021-06-24 11:07:51	13,22
515	2021-06-24 11:07:53	13,22
516	2021-06-24 11:07:55	13,22
517	2021-06-24 11:07:57	13,22
518	2021-06-24 11:07:59	13,22
519	2021-06-24 11:08:01	13,22
520	2021-06-24 11:08:03	13,22
521	2021-06-24 11:08:15	13,28
522	2021-06-24 11:08:21	13,28
523	2021-06-24 11:08:25	13,28
524	2021-06-24 11:08:27	13,28
525	2021-06-24 11:08:29	13,28
526	2021-06-24 11:08:31	13,28
527	2021-06-24 11:08:35	13,28
528	2021-06-24 11:08:37	13,28
529	2021-06-24 11:08:55	13,28
530	2021-06-24 11:08:57	13,28
531	2021-06-24 11:08:59	13,28
532	2021-06-24 11:09:07	13,28
533	2021-06-24 11:09:09	13,28
534	2021-06-24 11:09:15	13,28
535	2021-06-24 11:09:19	13,28
536	2021-06-24 11:09:21	13,28
537	2021-06-24 11:09:23	13,28
538	2021-06-24 11:09:25	13,28
539	2021-06-24 11:09:44	13,28
540	2021-06-24 11:09:52	13,28

541	2021-06-24 11:10:00	13,33
542	2021-06-24 11:10:02	13,33
543	2021-06-24 11:10:04	13,33
544	2021-06-24 11:10:06	13,33
545	2021-06-24 11:10:36	13,33
546	2021-06-24 11:10:38	13,33
547	2021-06-24 11:10:40	13,33
548	2021-06-24 11:11:55	13,33
549	2021-06-24 11:11:57	13,33
550	2021-06-24 11:11:59	13,33
551	2021-06-24 11:12:01	13,33
552	2021-06-24 11:12:03	13,39
553	2021-06-24 11:12:19	13,39
554	2021-06-24 11:12:23	13,39
555	2021-06-24 11:12:25	13,39
556	2021-06-24 11:12:27	13,39
557	2021-06-24 11:12:29	13,39
558	2021-06-24 11:12:31	13,39
559	2021-06-24 11:12:33	13,39
560	2021-06-24 11:12:40	13,39
561	2021-06-24 11:12:42	13,39
562	2021-06-24 11:12:44	13,39
563	2021-06-24 11:12:52	13,39
564	2021-06-24 11:12:56	13,39
565	2021-06-24 11:12:58	13,39
566	2021-06-24 11:13:00	13,39
567	2021-06-24 11:13:02	13,39
568	2021-06-24 11:13:04	13,44
569	2021-06-24 11:13:06	13,44
570	2021-06-24 11:13:12	13,44
571	2021-06-24 11:13:16	13,44
572	2021-06-24 11:13:18	13,44
573	2021-06-24 11:13:25	13,44
574	2021-06-24 11:13:27	13,44
575	2021-06-24 11:13:29	13,44
576	2021-06-24 11:13:31	13,44
577	2021-06-24 11:13:33	13,44
578	2021-06-24 11:13:35	13,44
579	2021-06-24 11:13:37	13,44
580	2021-06-24 11:13:39	13,44
581	2021-06-24 11:13:41	13,44
582	2021-06-24 11:13:43	13,44

583	2021-06-24 11:13:45	13,44
584	2021-06-24 11:13:47	13,44
585	2021-06-24 11:13:51	13,44
586	2021-06-24 11:13:53	13,44
587	2021-06-24 11:13:55	13,44
588	2021-06-24 11:13:57	13,44
589	2021-06-24 11:14:03	13,44
590	2021-06-24 11:14:24	13,50
591	2021-06-24 11:14:26	13,44
592	2021-06-24 11:14:42	13,44
593	2021-06-24 11:14:44	13,44
594	2021-06-24 11:14:46	13,50
595	2021-06-24 11:14:48	13,50
596	2021-06-24 11:15:11	13,50
597	2021-06-24 11:15:13	13,50
598	2021-06-24 11:15:15	13,50
599	2021-06-24 11:15:17	13,50
600	2021-06-24 11:15:19	13,50
601	2021-06-24 11:15:21	13,50
602	2021-06-24 11:15:23	13,50
603	2021-06-24 11:15:25	13,50
604	2021-06-24 11:15:27	13,50
605	2021-06-24 11:15:29	13,50
606	2021-06-24 11:15:31	13,50
607	2021-06-24 11:15:33	13,50
608	2021-06-24 11:15:49	13,50
609	2021-06-24 11:15:57	13,50
610	2021-06-24 11:16:07	13,50
611	2021-06-24 11:16:11	13,50
612	2021-06-24 11:16:13	13,50
613	2021-06-24 11:16:15	13,50
614	2021-06-24 11:16:17	13,50
615	2021-06-24 11:16:19	13,44
616	2021-06-24 11:16:25	13,44
617	2021-06-24 11:16:27	13,44
618	2021-06-24 11:16:29	13,50
619	2021-06-24 11:16:31	13,50
620	2021-06-24 11:16:33	13,50
621	2021-06-24 11:16:35	13,50
622	2021-06-24 11:16:37	13,50
623	2021-06-24 11:16:39	13,50
624	2021-06-24 11:16:41	13,50

625	2021-06-24 11:16:43	13,50
626	2021-06-24 11:16:45	13,50
627	2021-06-24 11:17:10	13,44
628	2021-06-24 11:17:12	13,44
629	2021-06-24 11:17:14	13,44
630	2021-06-24 11:17:16	13,44
631	2021-06-24 11:17:18	13,44
632	2021-06-24 11:17:20	13,50
633	2021-06-24 11:17:22	13,50
634	2021-06-24 11:17:24	13,50
635	2021-06-24 11:17:26	13,50
636	2021-06-24 11:17:28	13,50
637	2021-06-24 11:17:30	13,50
638	2021-06-24 11:17:40	13,50
639	2021-06-24 11:17:42	13,50
640	2021-06-24 11:17:44	13,50
641	2021-06-24 11:17:46	13,50
642	2021-06-24 11:17:48	13,50
643	2021-06-24 11:17:55	13,50
644	2021-06-24 11:17:57	13,50
645	2021-06-24 11:17:59	13,50
646	2021-06-24 11:18:01	13,50
647	2021-06-24 11:18:03	13,50
648	2021-06-24 11:18:05	13,50
649	2021-06-24 11:18:07	13,50
650	2021-06-24 11:18:13	13,50
651	2021-06-24 11:18:15	13,50
652	2021-06-24 11:18:17	13,50
653	2021-06-24 11:18:19	13,50
654	2021-06-24 11:18:21	13,50
655	2021-06-24 11:18:25	13,50
656	2021-06-24 11:18:27	13,50
657	2021-06-24 11:18:29	13,50
658	2021-06-24 11:18:31	13,50
659	2021-06-24 11:18:33	13,50
660	2021-06-24 11:18:40	13,50
661	2021-06-24 11:18:42	13,50
662	2021-06-24 11:18:48	13,50
663	2021-06-24 11:18:50	13,50
664	2021-06-24 11:18:52	13,50
665	2021-06-24 11:18:54	13,50
666	2021-06-24 11:18:56	13,50

667	2021-06-24 11:19:08	13,50
668	2021-06-24 11:19:10	13,50
669	2021-06-24 11:19:12	13,50
670	2021-06-24 11:19:14	13,50
671	2021-06-24 11:19:55	13,56
672	2021-06-24 11:20:35	13,61
673	2021-06-24 11:20:37	13,61
674	2021-06-24 11:20:39	13,61
675	2021-06-24 11:20:41	13,61
676	2021-06-24 11:20:43	13,61
677	2021-06-24 11:20:45	13,61
678	2021-06-24 11:20:47	13,61
679	2021-06-24 11:20:49	13,61
680	2021-06-24 11:20:55	13,56
681	2021-06-24 11:20:57	13,56
682	2021-06-24 11:20:59	13,56
683	2021-06-24 11:21:01	13,56
684	2021-06-24 11:21:03	13,56
685	2021-06-24 11:21:05	13,56
686	2021-06-24 11:21:07	13,61
687	2021-06-24 11:21:11	13,61
688	2021-06-24 11:21:13	13,61
689	2021-06-24 11:21:27	13,67
690	2021-06-24 11:22:32	13,72
691	2021-06-24 11:22:34	13,72
692	2021-06-24 11:22:48	13,78
693	2021-06-24 11:22:50	13,78
694	2021-06-24 11:22:52	13,78
695	2021-06-24 11:22:54	13,78
696	2021-06-24 11:22:56	13,78
697	2021-06-24 11:22:58	13,78
698	2021-06-24 11:23:00	13,78
699	2021-06-24 11:23:02	13,78
700	2021-06-24 11:23:04	13,78
701	2021-06-24 11:23:11	13,83
702	2021-06-24 11:23:13	13,83
703	2021-06-24 11:23:15	13,83
704	2021-06-24 11:23:27	13,83
705	2021-06-24 11:23:29	13,83
706	2021-06-24 11:23:31	13,78
707	2021-06-24 11:23:43	13,83
708	2021-06-24 11:23:45	13,83

709	2021-06-24 11:23:47	13,83
710	2021-06-24 11:23:49	13,83
711	2021-06-24 11:23:55	13,83
712	2021-06-24 11:23:57	13,83
713	2021-06-24 11:23:59	13,83
714	2021-06-24 11:24:01	13,83
715	2021-06-24 11:24:03	13,83
716	2021-06-24 11:24:05	13,83
717	2021-06-24 11:24:07	13,83
718	2021-06-24 11:24:09	13,83
719	2021-06-24 11:24:11	13,83
720	2021-06-24 11:24:13	13,83
721	2021-06-24 11:24:15	13,83
722	2021-06-24 11:24:17	13,83
723	2021-06-24 11:24:19	13,83
724	2021-06-24 11:24:23	13,83
725	2021-06-24 11:24:25	13,83
726	2021-06-24 11:24:27	13,83
727	2021-06-24 11:24:29	13,83
728	2021-06-24 11:24:31	13,89
729	2021-06-24 11:24:33	13,89
730	2021-06-24 11:24:40	13,83
731	2021-06-24 11:24:42	13,83
732	2021-06-24 11:24:44	13,83
733	2021-06-24 11:24:46	13,83
734	2021-06-24 11:24:48	13,83
735	2021-06-24 11:24:50	13,83
736	2021-06-24 11:24:52	13,89
737	2021-06-24 11:24:54	13,89
738	2021-06-24 11:24:56	13,89
739	2021-06-24 11:24:58	13,89
740	2021-06-24 11:25:00	13,89
741	2021-06-24 11:25:02	13,89
742	2021-06-24 11:25:04	13,89
743	2021-06-24 11:25:08	13,89
744	2021-06-24 11:25:10	13,89
745	2021-06-24 11:25:12	13,94
746	2021-06-24 11:25:31	13,94
747	2021-06-24 11:26:03	13,94
748	2021-06-24 11:26:10	13,94
749	2021-06-24 11:26:12	13,94
750	2021-06-24 11:26:14	13,94



751	2021-06-24 11:26:16	13,94
752	2021-06-24 11:26:18	13,94
753	2021-06-24 11:26:20	13,94
754	2021-06-24 11:26:22	13,94
755	2021-06-24 11:26:24	13,94
756	2021-06-24 11:26:26	13,94
757	2021-06-24 11:26:28	13,94
758	2021-06-24 11:26:30	13,94
759	2021-06-24 11:26:34	13,94
760	2021-06-24 11:26:38	13,94
761	2021-06-24 11:26:40	13,94
762	2021-06-24 11:26:42	13,94
763	2021-06-24 11:26:44	13,94
764	2021-06-24 11:26:48	13,94
765	2021-06-24 11:27:01	13,94
766	2021-06-24 11:27:04	13,94
767	2021-06-24 11:27:05	13,94
768	2021-06-24 11:27:09	13,94
769	2021-06-24 11:27:11	13,94
770	2021-06-24 11:27:14	13,94
771	2021-06-24 11:27:16	13,94
772	2021-06-24 11:27:18	13,94
773	2021-06-24 11:27:20	13,94
774	2021-06-24 11:27:22	13,94
775	2021-06-24 11:27:26	13,94
776	2021-06-24 11:27:28	13,94
777	2021-06-24 11:27:30	13,94
778	2021-06-24 11:27:32	13,94
779	2021-06-24 11:27:34	13,94
780	2021-06-24 11:27:49	13,89
781	2021-06-24 11:27:55	13,89
782	2021-06-24 11:27:57	13,94
783	2021-06-24 11:27:59	13,94
784	2021-06-24 11:28:01	13,94
785	2021-06-24 11:28:03	13,94
786	2021-06-24 11:28:05	13,94
787	2021-06-24 11:28:07	13,94
788	2021-06-24 11:28:09	13,94
789	2021-06-24 11:28:11	13,94
790	2021-06-24 11:28:13	13,94
791	2021-06-24 11:28:15	13,94
792	2021-06-24 11:28:17	13,94

793	2021-06-24 11:28:19	13,94
794	2021-06-24 11:28:25	13,89
795	2021-06-24 11:28:27	13,89
796	2021-06-24 11:28:37	13,89
797	2021-06-24 11:28:39	13,89
798	2021-06-24 11:28:41	13,89
799	2021-06-24 11:28:43	13,89
800	2021-06-24 11:28:45	13,89
801	2021-06-24 11:28:47	13,89
802	2021-06-24 11:28:49	13,89
803	2021-06-24 11:28:51	13,89
804	2021-06-24 11:28:53	13,89
805	2021-06-24 11:29:03	13,89
806	2021-06-24 11:29:10	13,89
807	2021-06-24 11:29:12	13,89
808	2021-06-24 11:29:14	13,89
809	2021-06-24 11:29:16	13,89
810	2021-06-24 11:29:18	13,89
811	2021-06-24 11:29:20	13,89
812	2021-06-24 11:29:22	13,89
813	2021-06-24 11:29:24	13,89
814	2021-06-24 11:29:26	13,89
815	2021-06-24 11:29:28	13,89
816	2021-06-24 11:29:30	13,89
817	2021-06-24 11:29:32	13,89
818	2021-06-24 11:29:34	13,89
819	2021-06-24 11:29:46	13,89
820	2021-06-24 11:29:48	13,89
821	2021-06-24 11:30:03	13,94
822	2021-06-24 11:30:05	13,94
823	2021-06-24 11:30:07	13,94
824	2021-06-24 11:30:09	13,94
825	2021-06-24 11:30:11	13,94
826	2021-06-24 11:30:13	13,94
827	2021-06-24 11:30:15	13,94
828	2021-06-24 11:30:17	13,94
829	2021-06-24 11:30:19	13,94
830	2021-06-24 11:30:21	13,89
831	2021-06-24 11:30:23	13,89
832	2021-06-24 11:30:25	13,89
833	2021-06-24 11:30:27	13,89
834	2021-06-24 11:30:29	13,89

835	2021-06-24 11:30:31	13,89
836	2021-06-24 11:30:33	13,89
837	2021-06-24 11:30:40	13,89
838	2021-06-24 11:30:42	13,89
839	2021-06-24 11:30:44	13,89
840	2021-06-24 11:30:46	13,89
841	2021-06-24 11:30:48	13,89
842	2021-06-24 11:30:50	13,89
843	2021-06-24 11:30:58	13,89
844	2021-06-24 11:31:00	13,89
845	2021-06-24 11:31:02	13,89
846	2021-06-24 11:31:04	13,89
847	2021-06-24 11:31:10	13,94
848	2021-06-24 11:31:16	13,94
849	2021-06-24 11:31:18	13,94
850	2021-06-24 11:31:32	13,89
851	2021-06-24 11:31:34	13,89
852	2021-06-24 11:31:38	13,89
853	2021-06-24 11:31:46	13,89
854	2021-06-24 11:31:48	13,89
855	2021-06-24 11:31:50	13,89
856	2021-06-24 11:31:52	13,89
857	2021-06-24 11:31:54	13,94
858	2021-06-24 11:31:56	13,94
859	2021-06-24 11:31:58	13,94
860	2021-06-24 11:32:00	13,94
861	2021-06-24 11:32:02	13,94
862	2021-06-24 11:32:25	13,94
863	2021-06-24 11:32:27	13,94
864	2021-06-24 11:32:29	13,94
865	2021-06-24 11:32:31	13,94
866	2021-06-24 11:32:33	13,94
867	2021-06-24 11:32:35	13,94
868	2021-06-24 11:32:37	13,94
869	2021-06-24 11:32:41	13,94
870	2021-06-24 11:32:49	13,89
871	2021-06-24 11:33:00	13,94
872	2021-06-24 11:33:02	13,94
873	2021-06-24 11:33:08	13,94
874	2021-06-24 11:33:16	13,94
875	2021-06-24 11:33:26	13,94
876	2021-06-24 11:33:28	13,94

877	2021-06-24 11:33:30	13,94
878	2021-06-24 11:34:00	13,94
879	2021-06-24 11:34:02	13,94
880	2021-06-24 11:34:25	13,94
881	2021-06-24 11:34:27	13,94
882	2021-06-24 11:34:29	13,94
883	2021-06-24 11:34:31	13,94
884	2021-06-24 11:34:33	13,94
885	2021-06-24 11:34:35	13,94
886	2021-06-24 11:34:37	13,94
887	2021-06-24 11:34:55	13,94
888	2021-06-24 11:34:57	13,94
889	2021-06-24 11:35:24	14,00
890	2021-06-24 11:35:26	14,00
891	2021-06-24 11:35:28	14,00
892	2021-06-24 11:35:30	14,00
893	2021-06-24 11:35:32	14,00
894	2021-06-24 11:35:34	14,00
895	2021-06-24 11:36:01	14,06
896	2021-06-24 11:36:04	14,06
897	2021-06-24 11:36:06	14,06
898	2021-06-24 11:36:10	14,06
899	2021-06-24 11:36:12	14,06
900	2021-06-24 11:36:14	14,06
901	2021-06-24 11:36:16	14,06
902	2021-06-24 11:36:18	14,06
903	2021-06-24 11:36:20	14,06
904	2021-06-24 11:39:08	14,28
905	2021-06-24 11:39:16	14,33
906	2021-06-24 11:39:18	14,33
907	2021-06-24 11:39:24	14,33
908	2021-06-24 11:39:47	14,39
909	2021-06-24 11:39:51	14,39
910	2021-06-24 11:39:53	14,39
911	2021-06-24 11:40:05	14,39
912	2021-06-24 11:40:07	14,39
913	2021-06-24 11:40:09	14,39
914	2021-06-24 11:40:11	14,39
915	2021-06-24 11:40:13	14,39
916	2021-06-24 11:40:15	14,44
917	2021-06-24 11:40:17	14,44
918	2021-06-24 11:40:19	14,44

919	2021-06-24 11:40:26	14,44
920	2021-06-24 11:40:28	14,44
921	2021-06-24 11:40:30	14,44
922	2021-06-24 11:40:32	14,44
923	2021-06-24 11:40:34	14,44
924	2021-06-24 11:40:36	14,44
925	2021-06-24 11:40:38	14,44
926	2021-06-24 11:40:40	14,44
927	2021-06-24 11:40:42	14,44
928	2021-06-24 11:40:44	14,44
929	2021-06-24 11:40:46	14,44
930	2021-06-24 11:40:48	14,44
931	2021-06-24 11:40:50	14,44
932	2021-06-24 11:40:52	14,44
933	2021-06-24 11:40:54	14,44
934	2021-06-24 11:40:56	14,44
935	2021-06-24 11:40:58	14,44
936	2021-06-24 11:41:00	14,44
937	2021-06-24 11:41:02	14,44
938	2021-06-24 11:41:04	14,44
939	2021-06-24 11:42:03	14,50
940	2021-06-24 11:42:05	14,50
941	2021-06-24 11:42:07	14,50
942	2021-06-24 11:42:21	14,56
943	2021-06-24 11:42:23	14,56
944	2021-06-24 11:42:25	14,56
945	2021-06-24 11:42:27	14,50
946	2021-06-24 11:42:29	14,50
947	2021-06-24 11:42:31	14,50
948	2021-06-24 11:42:40	14,50
949	2021-06-24 11:42:42	14,50
950	2021-06-24 11:42:44	14,50
951	2021-06-24 11:42:46	14,50
952	2021-06-24 11:42:48	14,50
953	2021-06-24 11:42:50	14,50
954	2021-06-24 11:43:02	14,50
955	2021-06-24 11:43:04	14,50
956	2021-06-24 11:43:06	14,50
957	2021-06-24 11:43:10	14,50
958	2021-06-24 11:43:12	14,50
959	2021-06-24 11:43:14	14,50
960	2021-06-24 11:43:16	14,50

961	2021-06-24 11:43:18	14,50
962	2021-06-24 11:43:25	14,50
963	2021-06-24 11:43:27	14,50
964	2021-06-24 11:43:29	14,50
965	2021-06-24 11:43:37	14,50
966	2021-06-24 11:43:39	14,50
967	2021-06-24 11:43:41	14,50
968	2021-06-24 11:43:43	14,50
969	2021-06-24 11:43:53	14,50
970	2021-06-24 11:43:55	14,50
971	2021-06-24 11:44:03	14,50
972	2021-06-24 11:44:29	14,50
973	2021-06-24 11:44:31	14,50
974	2021-06-24 11:44:33	14,50
975	2021-06-24 11:44:39	14,50
976	2021-06-24 11:44:41	14,50
977	2021-06-24 11:44:47	14,50
978	2021-06-24 11:44:49	14,50
979	2021-06-24 11:44:56	14,50
980	2021-06-24 11:44:58	14,50
981	2021-06-24 11:45:00	14,50
982	2021-06-24 11:45:02	14,50
983	2021-06-24 11:45:04	14,50
984	2021-06-24 11:45:06	14,50
985	2021-06-24 11:45:08	14,50
986	2021-06-24 11:45:10	14,50
987	2021-06-24 11:45:12	14,50
988	2021-06-24 11:45:14	14,50
989	2021-06-24 11:45:16	14,50
990	2021-06-24 11:45:18	14,50
991	2021-06-24 11:45:20	14,50
992	2021-06-24 11:45:22	14,50
993	2021-06-24 11:45:24	14,50
994	2021-06-24 11:45:44	14,56
995	2021-06-24 11:45:46	14,56
996	2021-06-24 11:45:48	14,56
997	2021-06-24 11:45:56	14,56
998	2021-06-24 11:45:58	14,56
999	2021-06-24 11:46:00	14,56
1000	2021-06-24 11:46:02	14,56
1001	2021-06-24 11:46:04	14,56
1002	2021-06-24 11:46:06	14,56

1003	2021-06-24 11:46:12	14,56
1004	2021-06-24 11:46:33	14,56
1005	2021-06-24 11:46:35	14,56
1006	2021-06-24 11:47:26	14,61
1007	2021-06-24 11:47:28	14,61
1008	2021-06-24 11:47:30	14,61
1009	2021-06-24 11:47:32	14,61
1010	2021-06-24 11:47:34	14,61
1011	2021-06-24 11:47:36	14,61
1012	2021-06-24 11:47:38	14,61
1013	2021-06-24 11:47:40	14,61
1014	2021-06-24 11:47:42	14,61
1015	2021-06-24 11:47:44	14,61
1016	2021-06-24 11:47:46	14,61
1017	2021-06-24 11:47:48	14,61
1018	2021-06-24 11:48:40	14,67
1019	2021-06-24 11:48:42	14,67
1020	2021-06-24 11:48:44	14,67
1021	2021-06-24 11:48:46	14,67
1022	2021-06-24 11:48:48	14,67
1023	2021-06-24 11:48:50	14,67
1024	2021-06-24 11:48:52	14,67
1025	2021-06-24 11:48:54	14,67
1026	2021-06-24 11:48:56	14,72
1027	2021-06-24 11:48:58	14,72
1028	2021-06-24 11:49:00	14,72
1029	2021-06-24 11:49:02	14,72
1030	2021-06-24 11:49:04	14,72
1031	2021-06-24 11:49:06	14,72
1032	2021-06-24 11:49:31	14,78
1033	2021-06-24 11:49:59	14,78
1034	2021-06-24 11:50:01	14,78
1035	2021-06-24 11:50:03	14,78
1036	2021-06-24 11:50:28	14,83
1037	2021-06-24 11:50:30	14,83
1038	2021-06-24 11:50:38	14,89
1039	2021-06-24 11:50:40	14,89
1040	2021-06-24 11:50:56	14,83
1041	2021-06-24 11:50:58	14,83
1042	2021-06-24 11:51:00	14,83
1043	2021-06-24 11:51:08	14,89
1044	2021-06-24 11:51:10	14,89

1045	2021-06-24 11:51:12	14,89
1046	2021-06-24 11:51:14	14,89
1047	2021-06-24 11:51:22	14,89
1048	2021-06-24 11:51:24	14,89
1049	2021-06-24 11:51:26	14,89
1050	2021-06-24 11:51:28	14,89
1051	2021-06-24 11:51:30	14,89
1052	2021-06-24 11:51:32	14,94
1053	2021-06-24 11:51:34	14,94
1054	2021-06-24 11:51:51	14,94
1055	2021-06-24 11:51:53	14,94
1056	2021-06-24 11:51:57	14,94
1057	2021-06-24 11:51:59	14,94
1058	2021-06-24 11:52:05	14,94
1059	2021-06-24 11:52:09	14,94
1060	2021-06-24 11:52:11	14,94
1061	2021-06-24 11:52:13	14,94
1062	2021-06-24 11:52:15	14,94
1063	2021-06-24 11:52:17	14,94
1064	2021-06-24 11:52:19	14,94
1065	2021-06-24 11:52:26	14,94
1066	2021-06-24 11:52:28	14,94
1067	2021-06-24 11:52:30	14,94
1068	2021-06-24 11:52:32	14,94
1069	2021-06-24 11:52:42	14,94
1070	2021-06-24 11:52:50	14,94
1071	2021-06-24 11:52:52	14,89
1072	2021-06-24 11:52:54	14,89
1073	2021-06-24 11:52:56	14,89
1074	2021-06-24 11:52:58	14,89
1075	2021-06-24 11:53:00	14,89
1076	2021-06-24 11:53:04	14,94
1077	2021-06-24 11:53:16	14,89
1078	2021-06-24 11:53:20	14,89
1079	2021-06-24 11:53:26	14,89
1080	2021-06-24 11:53:44	14,89
1081	2021-06-24 11:54:03	14,89
1082	2021-06-24 11:54:05	14,89
1083	2021-06-24 11:54:09	14,89
1084	2021-06-24 11:54:11	14,89
1085	2021-06-24 11:54:13	14,89
1086	2021-06-24 11:54:15	14,89

1087	2021-06-24 11:54:17	14,89
1088	2021-06-24 11:54:19	14,89
1089	2021-06-24 11:54:25	14,83
1090	2021-06-24 11:54:40	14,83
1091	2021-06-24 11:54:42	14,83
1092	2021-06-24 11:54:44	14,83
1093	2021-06-24 11:54:46	14,83
1094	2021-06-24 11:54:48	14,83
1095	2021-06-24 11:54:56	14,83
1096	2021-06-24 11:55:06	14,78
1097	2021-06-24 11:55:10	14,78
1098	2021-06-24 11:55:16	14,78
1099	2021-06-24 11:55:18	14,78
1100	2021-06-24 11:55:31	14,78
1101	2021-06-24 11:55:33	14,78
1102	2021-06-24 11:55:49	14,78
1103	2021-06-24 11:55:51	14,78
1104	2021-06-24 11:55:55	14,78
1105	2021-06-24 11:55:57	14,78
1106	2021-06-24 11:55:59	14,78
1107	2021-06-24 11:56:03	14,78
1108	2021-06-24 11:56:39	14,72
1109	2021-06-24 11:56:56	14,67
1110	2021-06-24 11:56:58	14,67
1111	2021-06-24 11:57:04	14,67
1112	2021-06-24 11:57:08	14,72
1113	2021-06-24 11:57:14	14,72
1114	2021-06-24 11:57:16	14,72
1115	2021-06-24 11:57:22	14,67
1116	2021-06-24 11:57:24	14,67
1117	2021-06-24 11:57:26	14,67
1118	2021-06-24 11:57:34	14,67
1119	2021-06-24 11:57:40	14,67
1120	2021-06-24 11:57:42	14,67
1121	2021-06-24 11:57:54	14,61
1122	2021-06-24 11:57:56	14,61
1123	2021-06-24 11:57:58	14,61
1124	2021-06-24 11:58:04	14,61
1125	2021-06-24 11:58:06	14,61
1126	2021-06-24 11:58:10	14,56
1127	2021-06-24 11:58:12	14,56
1128	2021-06-24 11:58:31	14,56

1129	2021-06-24 11:58:33	14,56
1130	2021-06-24 11:58:35	14,56
1131	2021-06-24 11:58:37	14,56
1132	2021-06-24 11:58:39	14,56
1133	2021-06-24 11:58:41	14,50
1134	2021-06-24 11:58:43	14,50
1135	2021-06-24 11:58:45	14,50
1136	2021-06-24 11:58:51	14,50
1137	2021-06-24 11:58:53	14,50
1138	2021-06-24 11:58:57	14,50
1139	2021-06-24 11:59:24	14,44
1140	2021-06-24 11:59:26	14,44
1141	2021-06-24 11:59:28	14,44
1142	2021-06-24 11:59:30	14,44
1143	2021-06-24 11:59:32	14,39
1144	2021-06-24 11:59:55	14,39
1145	2021-06-24 11:59:57	14,39
1146	2021-06-24 11:59:59	14,39
1147	2021-06-24 12:00:01	14,39
1148	2021-06-24 12:00:07	14,39
1149	2021-06-24 12:00:09	14,39
1150	2021-06-24 12:00:11	14,39
1151	2021-06-24 12:00:13	14,39
1152	2021-06-24 12:00:15	14,39
1153	2021-06-24 12:00:21	14,39
1154	2021-06-24 12:00:23	14,39
1155	2021-06-24 12:00:41	14,33
1156	2021-06-24 12:00:43	14,33
1157	2021-06-24 12:00:45	14,33
1158	2021-06-24 12:00:47	14,33
1159	2021-06-24 12:00:49	14,33
1160	2021-06-24 12:00:51	14,33
1161	2021-06-24 12:00:53	14,33
1162	2021-06-24 12:00:55	14,33
1163	2021-06-24 12:00:59	14,33
1164	2021-06-24 12:01:01	14,33
1165	2021-06-24 12:01:03	14,33
1166	2021-06-24 12:01:05	14,33
1167	2021-06-24 12:01:15	14,33
1168	2021-06-24 12:01:26	14,33
1169	2021-06-24 12:01:28	14,33
1170	2021-06-24 12:01:34	14,33

1171	2021-06-24 12:01:36	14,33
1172	2021-06-24 12:01:38	14,33
1173	2021-06-24 12:01:40	14,33
1174	2021-06-24 12:01:52	14,33
1175	2021-06-24 12:01:54	14,33
1176	2021-06-24 12:01:58	14,33
1177	2021-06-24 12:02:00	14,33
1178	2021-06-24 12:02:11	14,33
1179	2021-06-24 12:02:13	14,33
1180	2021-06-24 12:02:15	14,33
1181	2021-06-24 12:02:17	14,33
1182	2021-06-24 12:02:19	14,33
1183	2021-06-24 12:02:21	14,33
1184	2021-06-24 12:02:23	14,33
1185	2021-06-24 12:02:25	14,33
1186	2021-06-24 12:03:09	14,39
1187	2021-06-24 12:03:13	14,39
1188	2021-06-24 12:03:15	14,39
1189	2021-06-24 12:03:17	14,39
1190	2021-06-24 12:03:19	14,39
1191	2021-06-24 12:03:21	14,39
1192	2021-06-24 12:03:25	14,39
1193	2021-06-24 12:03:27	14,39
1194	2021-06-24 12:03:33	14,39
1195	2021-06-24 12:03:46	14,33
1196	2021-06-24 12:03:50	14,39
1197	2021-06-24 12:03:52	14,39
1198	2021-06-24 12:03:56	14,39
1199	2021-06-24 12:03:58	14,39
1200	2021-06-24 12:04:00	14,39
1201	2021-06-24 12:04:02	14,39
1202	2021-06-24 12:04:04	14,39
1203	2021-06-24 12:04:06	14,39
1204	2021-06-24 12:04:12	14,39
1205	2021-06-24 12:04:14	14,39
1206	2021-06-24 12:04:25	14,33
1207	2021-06-24 12:04:27	14,33
1208	2021-06-24 12:04:37	14,33
1209	2021-06-24 12:04:39	14,33
1210	2021-06-24 12:04:41	14,33
1211	2021-06-24 12:04:53	14,33
1212	2021-06-24 12:05:01	14,33

1213	2021-06-24 12:05:21	14,33
1214	2021-06-24 12:05:29	14,33
1215	2021-06-24 12:05:37	14,33
1216	2021-06-24 12:05:39	14,33
1217	2021-06-24 12:05:41	14,33
1218	2021-06-24 12:05:43	14,33
1219	2021-06-24 12:05:45	14,33
1220	2021-06-24 12:05:47	14,33
1221	2021-06-24 12:05:49	14,33
1222	2021-06-24 12:05:56	14,33
1223	2021-06-24 12:05:58	14,33
1224	2021-06-24 12:06:00	14,33
1225	2021-06-24 12:06:02	14,33
1226	2021-06-24 12:06:06	14,33
1227	2021-06-24 12:06:14	14,33
1228	2021-06-24 12:06:16	14,33
1229	2021-06-24 12:06:28	14,33
1230	2021-06-24 12:06:30	14,33
1231	2021-06-24 12:06:32	14,33
1232	2021-06-24 12:06:41	14,33
1233	2021-06-24 12:06:43	14,33
1234	2021-06-24 12:06:45	14,33
1235	2021-06-24 12:06:47	14,33
1236	2021-06-24 12:07:01	14,33
1237	2021-06-24 12:07:03	14,33
1238	2021-06-24 12:07:05	14,33
1239	2021-06-24 12:07:07	14,33
1240	2021-06-24 12:07:49	14,33
1241	2021-06-24 12:07:51	14,33
1242	2021-06-24 12:07:53	14,33
1243	2021-06-24 12:07:55	14,33
1244	2021-06-24 12:07:57	14,33
1245	2021-06-24 12:07:59	14,33
1246	2021-06-24 12:08:01	14,33
1247	2021-06-24 12:08:03	14,33
1248	2021-06-24 12:08:10	14,33
1249	2021-06-24 12:08:12	14,33
1250	2021-06-24 12:08:22	14,33
1251	2021-06-24 12:08:34	14,33
1252	2021-06-24 12:08:36	14,33
1253	2021-06-24 12:08:38	14,33
1254	2021-06-24 12:08:40	14,33

1255	2021-06-24 12:08:42	14,33
1256	2021-06-24 12:08:44	14,33
1257	2021-06-24 12:08:46	14,39
1258	2021-06-24 12:08:55	14,39
1259	2021-06-24 12:08:57	14,39
1260	2021-06-24 12:08:59	14,39
1261	2021-06-24 12:09:05	14,39
1262	2021-06-24 12:09:07	14,39
1263	2021-06-24 12:09:11	14,39
1264	2021-06-24 12:09:13	14,39
1265	2021-06-24 12:09:19	14,39
1266	2021-06-24 12:09:21	14,39
1267	2021-06-24 12:09:23	14,39
1268	2021-06-24 12:09:25	14,39
1269	2021-06-24 12:09:27	14,39
1270	2021-06-24 12:09:45	14,39
1271	2021-06-24 12:09:47	14,39
1272	2021-06-24 12:09:49	14,39
1273	2021-06-24 12:09:51	14,39
1274	2021-06-24 12:09:53	14,39
1275	2021-06-24 12:10:01	14,33
1276	2021-06-24 12:10:03	14,33
1277	2021-06-24 12:10:05	14,33
1278	2021-06-24 12:10:07	14,33
1279	2021-06-24 12:10:09	14,39
1280	2021-06-24 12:10:19	14,33
1281	2021-06-24 12:10:38	14,33
1282	2021-06-24 12:10:40	14,33
1283	2021-06-24 12:10:50	14,33
1284	2021-06-24 12:10:56	14,33
1285	2021-06-24 12:11:04	14,33
1286	2021-06-24 12:11:11	14,33
1287	2021-06-24 12:11:13	14,33
1288	2021-06-24 12:11:15	14,33
1289	2021-06-24 12:11:17	14,33
1290	2021-06-24 12:11:19	14,33
1291	2021-06-24 12:11:21	14,33
1292	2021-06-24 12:11:23	14,33
1293	2021-06-24 12:11:31	14,28
1294	2021-06-24 12:11:33	14,28
1295	2021-06-24 12:11:35	14,28
1296	2021-06-24 12:11:37	14,28

1297	2021-06-24 12:11:39	14,28
1298	2021-06-24 12:11:41	14,28
1299	2021-06-24 12:11:43	14,28
1300	2021-06-24 12:11:45	14,28
1301	2021-06-24 12:11:47	14,28
1302	2021-06-24 12:11:49	14,28
1303	2021-06-24 12:11:55	14,28
1304	2021-06-24 12:11:57	14,28
1305	2021-06-24 12:11:59	14,28
1306	2021-06-24 12:12:03	14,28
1307	2021-06-24 12:12:05	14,28
1308	2021-06-24 12:12:07	14,28
1309	2021-06-24 12:12:11	14,28
1310	2021-06-24 12:12:19	14,28
1311	2021-06-24 12:12:29	14,22
1312	2021-06-24 12:12:40	14,22
1313	2021-06-24 12:12:42	14,22
1314	2021-06-24 12:12:44	14,22
1315	2021-06-24 12:12:48	14,22
1316	2021-06-24 12:12:50	14,22
1317	2021-06-24 12:12:54	14,22
1318	2021-06-24 12:13:06	14,22
1319	2021-06-24 12:13:08	14,22
1320	2021-06-24 12:13:33	14,22
1321	2021-06-24 12:13:35	14,22
1322	2021-06-24 12:13:37	14,22
1323	2021-06-24 12:13:39	14,22
1324	2021-06-24 12:13:57	14,17
1325	2021-06-24 12:14:03	14,17
1326	2021-06-24 12:14:16	14,17
1327	2021-06-24 12:14:18	14,17
1328	2021-06-24 12:14:24	14,17
1329	2021-06-24 12:14:26	14,17
1330	2021-06-24 12:14:33	14,17
1331	2021-06-24 12:14:37	14,17
1332	2021-06-24 12:14:39	14,17
1333	2021-06-24 12:14:41	14,17
1334	2021-06-24 12:14:47	14,17
1335	2021-06-24 12:14:49	14,17
1336	2021-06-24 12:15:04	14,17
1337	2021-06-24 12:15:14	14,11
1338	2021-06-24 12:15:20	14,17

1339	2021-06-24 12:15:22	14,17
1340	2021-06-24 12:15:24	14,17
1341	2021-06-24 12:15:26	14,11
1342	2021-06-24 12:15:28	14,11
1343	2021-06-24 12:15:30	14,11
1344	2021-06-24 12:15:32	14,11
1345	2021-06-24 12:15:34	14,11
1346	2021-06-24 12:15:41	14,11
1347	2021-06-24 12:15:43	14,11
1348	2021-06-24 12:15:45	14,11
1349	2021-06-24 12:15:55	14,11
1350	2021-06-24 12:15:59	14,11
1351	2021-06-24 12:16:05	14,11
1352	2021-06-24 12:16:09	14,11
1353	2021-06-24 12:16:11	14,11
1354	2021-06-24 12:16:17	14,11
1355	2021-06-24 12:16:19	14,11
1356	2021-06-24 12:16:27	14,11
1357	2021-06-24 12:16:29	14,11
1358	2021-06-24 12:16:31	14,11
1359	2021-06-24 12:16:37	14,11
1360	2021-06-24 12:16:39	14,11
1361	2021-06-24 12:16:45	14,11
1362	2021-06-24 12:16:47	14,11
1363	2021-06-24 12:16:49	14,11
1364	2021-06-24 12:16:55	14,11
1365	2021-06-24 12:16:57	14,11
1366	2021-06-24 12:17:03	14,11
1367	2021-06-24 12:17:05	14,11
1368	2021-06-24 12:17:17	14,11
1369	2021-06-24 12:17:19	14,11
1370	2021-06-24 12:17:23	14,11
1371	2021-06-24 12:17:25	14,11
1372	2021-06-24 12:17:27	14,11
1373	2021-06-24 12:17:29	14,11
1374	2021-06-24 12:17:37	14,11
1375	2021-06-24 12:17:39	14,11
1376	2021-06-24 12:17:41	14,11
1377	2021-06-24 12:17:43	14,11
1378	2021-06-24 12:17:45	14,11
1379	2021-06-24 12:17:47	14,11
1380	2021-06-24 12:18:04	14,11

1381	2021-06-24 12:18:06	14,11
1382	2021-06-24 12:18:08	14,11
1383	2021-06-24 12:18:14	14,11
1384	2021-06-24 12:18:22	14,11
1385	2021-06-24 12:18:26	14,11
1386	2021-06-24 12:18:28	14,11
1387	2021-06-24 12:18:30	14,11
1388	2021-06-24 12:18:34	14,06
1389	2021-06-24 12:18:41	14,06
1390	2021-06-24 12:18:43	14,06
1391	2021-06-24 12:18:45	14,06
1392	2021-06-24 12:18:47	14,06
1393	2021-06-24 12:18:49	14,06
1394	2021-06-24 12:18:51	14,06
1395	2021-06-24 12:18:53	14,06
1396	2021-06-24 12:18:55	14,06
1397	2021-06-24 12:18:57	14,06
1398	2021-06-24 12:18:59	14,06
1399	2021-06-24 12:19:01	14,11
1400	2021-06-24 12:19:03	14,11
1401	2021-06-24 12:19:05	14,11
1402	2021-06-24 12:19:19	14,11
1403	2021-06-24 12:19:25	14,11
1404	2021-06-24 12:19:27	14,11
1405	2021-06-24 12:19:29	14,11
1406	2021-06-24 12:19:31	14,06
1407	2021-06-24 12:19:33	14,06
1408	2021-06-24 12:19:35	14,06
1409	2021-06-24 12:19:37	14,06
1410	2021-06-24 12:19:45	14,06
1411	2021-06-24 12:19:47	14,06
1412	2021-06-24 12:19:55	14,11
1413	2021-06-24 12:19:57	14,11
1414	2021-06-24 12:19:59	14,11
1415	2021-06-24 12:20:10	14,11
1416	2021-06-24 12:20:12	14,11
1417	2021-06-24 12:20:14	14,11
1418	2021-06-24 12:20:16	14,11
1419	2021-06-24 12:20:18	14,11
1420	2021-06-24 12:20:20	14,11
1421	2021-06-24 12:20:28	14,06
1422	2021-06-24 12:20:30	14,06



1423	2021-06-24 12:20:48	14,11
1424	2021-06-24 12:21:01	14,11
1425	2021-06-24 12:21:03	14,11
1426	2021-06-24 12:21:05	14,11
1427	2021-06-24 12:21:15	14,11
1428	2021-06-24 12:21:33	14,11
1429	2021-06-24 12:21:41	14,11
1430	2021-06-24 12:21:43	14,11
1431	2021-06-24 12:21:45	14,11
1432	2021-06-24 12:21:53	14,11
1433	2021-06-24 12:21:59	14,11
1434	2021-06-24 12:22:03	14,11
1435	2021-06-24 12:22:05	14,11
1436	2021-06-24 12:22:07	14,11
1437	2021-06-24 12:22:09	14,11
1438	2021-06-24 12:22:13	14,11
1439	2021-06-24 12:22:19	14,11
1440	2021-06-24 12:22:38	14,11
1441	2021-06-24 12:22:40	14,11
1442	2021-06-24 12:22:46	14,11
1443	2021-06-24 12:22:48	14,11
1444	2021-06-24 12:22:50	14,11
1445	2021-06-24 12:23:11	14,11
1446	2021-06-24 12:23:13	14,11
1447	2021-06-24 12:23:15	14,11
1448	2021-06-24 12:23:21	14,11
1449	2021-06-24 12:23:23	14,11
1450	2021-06-24 12:23:25	14,11
1451	2021-06-24 12:23:27	14,11
1452	2021-06-24 12:23:29	14,11
1453	2021-06-24 12:23:31	14,11
1454	2021-06-24 12:23:35	14,11
1455	2021-06-24 12:24:11	14,11
1456	2021-06-24 12:24:21	14,11
1457	2021-06-24 12:24:23	14,11
1458	2021-06-24 12:24:25	14,11
1459	2021-06-24 12:24:27	14,11
1460	2021-06-24 12:24:29	14,11
1461	2021-06-24 12:24:31	14,11
1462	2021-06-24 12:24:33	14,11
1463	2021-06-24 12:24:46	14,06
1464	2021-06-24 12:24:48	14,11

1465	2021-06-24 12:24:50	14,11
1466	2021-06-24 12:25:02	14,11
1467	2021-06-24 12:25:04	14,11
1468	2021-06-24 12:25:06	14,11
1469	2021-06-24 12:25:12	14,11
1470	2021-06-24 12:25:16	14,11
1471	2021-06-24 12:25:18	14,11
1472	2021-06-24 12:25:25	14,11
1473	2021-06-24 12:25:27	14,11
1474	2021-06-24 12:25:29	14,11
1475	2021-06-24 12:25:31	14,17
1476	2021-06-24 12:25:33	14,17
1477	2021-06-24 12:25:35	14,17
1478	2021-06-24 12:25:37	14,17
1479	2021-06-24 12:25:39	14,17
1480	2021-06-24 12:25:41	14,17
1481	2021-06-24 12:25:43	14,17
1482	2021-06-24 12:25:45	14,17
1483	2021-06-24 12:25:47	14,17
1484	2021-06-24 12:25:49	14,17
1485	2021-06-24 12:25:51	14,22
1486	2021-06-24 12:25:53	14,22
1487	2021-06-24 12:25:55	14,22
1488	2021-06-24 12:26:10	14,17
1489	2021-06-24 12:26:12	14,17
1490	2021-06-24 12:26:14	14,17
1491	2021-06-24 12:26:16	14,17
1492	2021-06-24 12:26:18	14,17
1493	2021-06-24 12:26:20	14,22
1494	2021-06-24 12:26:22	14,22
1495	2021-06-24 12:26:24	14,22
1496	2021-06-24 12:26:28	14,22
1497	2021-06-24 12:26:30	14,22
1498	2021-06-24 12:26:32	14,22
1499	2021-06-24 12:26:34	14,22
1500	2021-06-24 12:26:38	14,22
1501	2021-06-24 12:26:40	14,22
1502	2021-06-24 12:26:42	14,22
1503	2021-06-24 12:26:44	14,22
1504	2021-06-24 12:26:46	14,22
1505	2021-06-24 12:26:48	14,22
1506	2021-06-24 12:27:02	14,28

1507	2021-06-24 12:27:08	14,28
1508	2021-06-24 12:27:14	14,22
1509	2021-06-24 12:27:16	14,22
1510	2021-06-24 12:27:18	14,22
1511	2021-06-24 12:27:26	14,22
1512	2021-06-24 12:27:51	14,28
1513	2021-06-24 12:27:53	14,28
1514	2021-06-24 12:27:55	14,28
1515	2021-06-24 12:28:01	14,28
1516	2021-06-24 12:28:03	14,28
1517	2021-06-24 12:28:07	14,28
1518	2021-06-24 12:28:09	14,28
1519	2021-06-24 12:28:11	14,28
1520	2021-06-24 12:28:13	14,28
1521	2021-06-24 12:28:17	14,28
1522	2021-06-24 12:28:19	14,28
1523	2021-06-24 12:28:32	14,28
1524	2021-06-24 12:28:36	14,28
1525	2021-06-24 12:28:38	14,28
1526	2021-06-24 12:28:40	14,28
1527	2021-06-24 12:28:52	14,28
1528	2021-06-24 12:29:00	14,28
1529	2021-06-24 12:29:02	14,28
1530	2021-06-24 12:29:04	14,28
1531	2021-06-24 12:29:10	14,28
1532	2021-06-24 12:29:12	14,28
1533	2021-06-24 12:29:14	14,28
1534	2021-06-24 12:29:16	14,33
1535	2021-06-24 12:29:20	14,33
1536	2021-06-24 12:29:22	14,33
1537	2021-06-24 12:29:24	14,33
1538	2021-06-24 12:29:26	14,33
1539	2021-06-24 12:29:28	14,33
1540	2021-06-24 12:29:30	14,33
1541	2021-06-24 12:29:32	14,33
1542	2021-06-24 12:29:34	14,33
1543	2021-06-24 12:29:36	14,33
1544	2021-06-24 12:29:38	14,33
1545	2021-06-24 12:29:44	14,33
1546	2021-06-24 12:29:55	14,33
1547	2021-06-24 12:29:57	14,33
1548	2021-06-24 12:29:59	14,33

1549	2021-06-24 12:30:01	14,33
1550	2021-06-24 12:30:03	14,33
1551	2021-06-24 12:30:11	14,33
1552	2021-06-24 12:30:13	14,33
1553	2021-06-24 12:30:15	14,33
1554	2021-06-24 12:30:17	14,39
1555	2021-06-24 12:30:19	14,39
1556	2021-06-24 12:30:25	14,39
1557	2021-06-24 12:30:40	14,39
1558	2021-06-24 12:30:42	14,39
1559	2021-06-24 12:30:44	14,39
1560	2021-06-24 12:30:46	14,39
1561	2021-06-24 12:30:56	14,33
1562	2021-06-24 12:31:00	14,39
1563	2021-06-24 12:31:06	14,39
1564	2021-06-24 12:31:08	14,39
1565	2021-06-24 12:31:10	14,39
1566	2021-06-24 12:31:12	14,39
1567	2021-06-24 12:31:14	14,39
1568	2021-06-24 12:31:16	14,39
1569	2021-06-24 12:31:18	14,39
1570	2021-06-24 12:31:26	14,39
1571	2021-06-24 12:31:28	14,39
1572	2021-06-24 12:31:30	14,39
1573	2021-06-24 12:31:32	14,39
1574	2021-06-24 12:31:38	14,39
1575	2021-06-24 12:31:40	14,39
1576	2021-06-24 12:31:42	14,39
1577	2021-06-24 12:31:44	14,39
1578	2021-06-24 12:31:46	14,39
1579	2021-06-24 12:32:23	14,44
1580	2021-06-24 12:32:31	14,44
1581	2021-06-24 12:32:41	14,50
1582	2021-06-24 12:32:43	14,50
1583	2021-06-24 12:32:45	14,50
1584	2021-06-24 12:32:47	14,50
1585	2021-06-24 12:33:04	14,44
1586	2021-06-24 12:33:28	14,50
1587	2021-06-24 12:33:30	14,50
1588	2021-06-24 12:33:32	14,44
1589	2021-06-24 12:33:34	14,44
1590	2021-06-24 12:33:50	14,50

1591	2021-06-24 12:33:52	14,44
1592	2021-06-24 12:33:54	14,44
1593	2021-06-24 12:33:56	14,44
1594	2021-06-24 12:34:00	14,44
1595	2021-06-24 12:34:02	14,50
1596	2021-06-24 12:34:04	14,50
1597	2021-06-24 12:34:06	14,50
1598	2021-06-24 12:34:10	14,50
1599	2021-06-24 12:34:12	14,44
1600	2021-06-24 12:34:14	14,44
1601	2021-06-24 12:34:16	14,44
1602	2021-06-24 12:34:33	14,50
1603	2021-06-24 12:34:35	14,50
1604	2021-06-24 12:34:39	14,50
1605	2021-06-24 12:34:41	14,50
1606	2021-06-24 12:34:43	14,50
1607	2021-06-24 12:34:45	14,50
1608	2021-06-24 12:34:49	14,50
1609	2021-06-24 12:34:59	14,50
1610	2021-06-24 12:35:01	14,50
1611	2021-06-24 12:35:03	14,50
1612	2021-06-24 12:35:20	14,50
1613	2021-06-24 12:35:22	14,50
1614	2021-06-24 12:35:24	14,50
1615	2021-06-24 12:35:32	14,50
1616	2021-06-24 12:35:34	14,50
1617	2021-06-24 12:35:36	14,50
1618	2021-06-24 12:35:38	14,50
1619	2021-06-24 12:36:10	14,56
1620	2021-06-24 12:36:12	14,56
1621	2021-06-24 12:36:14	14,56
1622	2021-06-24 12:36:16	14,56
1623	2021-06-24 12:36:18	14,56
1624	2021-06-24 12:36:26	14,56
1625	2021-06-24 12:36:41	14,56
1626	2021-06-24 12:36:43	14,56
1627	2021-06-24 12:36:45	14,56
1628	2021-06-24 12:36:47	14,56
1629	2021-06-24 12:36:53	14,56
1630	2021-06-24 12:37:09	14,56
1631	2021-06-24 12:37:11	14,56
1632	2021-06-24 12:37:17	14,61

1633	2021-06-24 12:37:19	14,61
1634	2021-06-24 12:37:34	14,56
1635	2021-06-24 12:37:36	14,56
1636	2021-06-24 12:37:38	14,61
1637	2021-06-24 12:37:40	14,61
1638	2021-06-24 12:37:42	14,61
1639	2021-06-24 12:37:44	14,61
1640	2021-06-24 12:37:50	14,61
1641	2021-06-24 12:37:52	14,61
1642	2021-06-24 12:37:54	14,61
1643	2021-06-24 12:37:56	14,61
1644	2021-06-24 12:37:58	14,61
1645	2021-06-24 12:38:00	14,61
1646	2021-06-24 12:38:02	14,61
1647	2021-06-24 12:38:17	14,61
1648	2021-06-24 12:38:21	14,61
1649	2021-06-24 12:38:23	14,61
1650	2021-06-24 12:38:25	14,61
1651	2021-06-24 12:38:27	14,61
1652	2021-06-24 12:38:29	14,61
1653	2021-06-24 12:38:31	14,61
1654	2021-06-24 12:38:33	14,61
1655	2021-06-24 12:38:43	14,67
1656	2021-06-24 12:38:45	14,67
1657	2021-06-24 12:38:47	14,67
1658	2021-06-24 12:38:49	14,67
1659	2021-06-24 12:38:55	14,61
1660	2021-06-24 12:38:57	14,61
1661	2021-06-24 12:38:59	14,61
1662	2021-06-24 12:39:01	14,61
1663	2021-06-24 12:39:03	14,61
1664	2021-06-24 12:39:05	14,61
1665	2021-06-24 12:39:07	14,61
1666	2021-06-24 12:39:09	14,61
1667	2021-06-24 12:39:11	14,61
1668	2021-06-24 12:39:13	14,61
1669	2021-06-24 12:39:31	14,67
1670	2021-06-24 12:39:33	14,67
1671	2021-06-24 12:39:40	14,67
1672	2021-06-24 12:39:42	14,67
1673	2021-06-24 12:39:44	14,67
1674	2021-06-24 12:39:46	14,67

1675	2021-06-24 12:39:48	14,67
1676	2021-06-24 12:39:50	14,67
1677	2021-06-24 12:39:52	14,67
1678	2021-06-24 12:39:54	14,67
1679	2021-06-24 12:39:56	14,67
1680	2021-06-24 12:39:58	14,67
1681	2021-06-24 12:40:00	14,67
1682	2021-06-24 12:40:02	14,67
1683	2021-06-24 12:40:04	14,67
1684	2021-06-24 12:40:06	14,67
1685	2021-06-24 12:40:36	14,67
1686	2021-06-24 12:40:38	14,67
1687	2021-06-24 12:40:40	14,67
1688	2021-06-24 12:40:42	14,67
1689	2021-06-24 12:40:44	14,72
1690	2021-06-24 12:40:46	14,72
1691	2021-06-24 12:40:48	14,72
1692	2021-06-24 12:40:50	14,72
1693	2021-06-24 12:40:52	14,72
1694	2021-06-24 12:40:54	14,72
1695	2021-06-24 12:40:56	14,72
1696	2021-06-24 12:40:58	14,72
1697	2021-06-24 12:41:00	14,72
1698	2021-06-24 12:41:02	14,72
1699	2021-06-24 12:41:31	14,78
1700	2021-06-24 12:41:33	14,78
1701	2021-06-24 12:41:35	14,78
1702	2021-06-24 12:41:37	14,78
1703	2021-06-24 12:41:39	14,78
1704	2021-06-24 12:41:41	14,78
1705	2021-06-24 12:41:43	14,78
1706	2021-06-24 12:41:45	14,78
1707	2021-06-24 12:41:47	14,78
1708	2021-06-24 12:41:49	14,78
1709	2021-06-24 12:41:56	14,83
1710	2021-06-24 12:41:58	14,83
1711	2021-06-24 12:42:00	14,83
1712	2021-06-24 12:42:02	14,83
1713	2021-06-24 12:42:04	14,83
1714	2021-06-24 12:42:06	14,83
1715	2021-06-24 12:43:03	14,89
1716	2021-06-24 12:43:05	14,89

1717	2021-06-24 12:43:07	14,89
1718	2021-06-24 12:43:19	14,94
1719	2021-06-24 12:43:25	14,94
1720	2021-06-24 12:43:27	14,94
1721	2021-06-24 12:43:29	14,94
1722	2021-06-24 12:43:31	14,94
1723	2021-06-24 12:43:33	14,94
1724	2021-06-24 12:43:39	14,94
1725	2021-06-24 12:43:41	14,94
1726	2021-06-24 12:43:53	14,94
1727	2021-06-24 12:43:55	14,94
1728	2021-06-24 12:44:01	14,94
1729	2021-06-24 12:44:03	14,94
1730	24-06-2021 12:44:10	14,94
1731	24-06-2021 12:44:12	14,94
1732	24-06-2021 12:44:14	14,94
1733	24-06-2021 12:44:16	14,94
1734	24-06-2021 12:44:20	14,94
1735	24-06-2021 12:44:46	14,94
1736	2021-06-24 12:44:55	15,06
1737	2021-06-24 12:44:57	15,06
1738	2021-06-24 12:44:59	15,06
1739	2021-06-24 12:45:01	15,06
1740	2021-06-24 12:45:03	15,06
1741	2021-06-24 12:45:11	15,06
1742	2021-06-24 12:45:13	15,06
1743	2021-06-24 12:45:17	15,06
1744	2021-06-24 12:45:19	15,06
1745	2021-06-24 12:45:21	15,06
1746	2021-06-24 12:45:23	15,06
1747	2021-06-24 12:45:25	15,06
1748	2021-06-24 12:45:29	15,06
1749	2021-06-24 12:45:31	15,06
1750	2021-06-24 12:46:26	15,11
1751	2021-06-24 12:46:28	15,11
1752	2021-06-24 12:46:54	15,11
1753	2021-06-24 12:46:56	15,11
1754	2021-06-24 12:47:11	15,17
1755	2021-06-24 12:47:13	15,17
1756	2021-06-24 12:47:15	15,17
1757	2021-06-24 12:47:27	15,17
1758	2021-06-24 12:47:29	15,17

1759	2021-06-24 12:47:31	15,17
1760	2021-06-24 12:47:39	15,17
1761	2021-06-24 12:48:00	15,17
1762	2021-06-24 12:48:02	15,22
1763	2021-06-24 12:48:04	15,22
1764	2021-06-24 12:48:08	15,22
1765	2021-06-24 12:48:10	15,22
1766	2021-06-24 12:48:12	15,22
1767	2021-06-24 12:48:14	15,22
1768	2021-06-24 12:48:16	15,22
1769	2021-06-24 12:48:18	15,22
1770	2021-06-24 12:48:20	15,22
1771	2021-06-24 12:48:22	15,22
1772	2021-06-24 12:48:24	15,22
1773	2021-06-24 12:48:26	15,22
1774	2021-06-24 12:48:28	15,22
1775	2021-06-24 12:48:30	15,22
1776	2021-06-24 12:48:32	15,22
1777	2021-06-24 12:48:46	15,28
1778	2021-06-24 12:49:04	15,28
1779	2021-06-24 12:49:06	15,28
1780	2021-06-24 12:49:08	15,28
1781	2021-06-24 12:49:10	15,28
1782	2021-06-24 12:49:12	15,28
1783	2021-06-24 12:49:14	15,28
1784	2021-06-24 12:49:16	15,28
1785	2021-06-24 12:49:18	15,28
1786	2021-06-24 12:49:31	15,28
1787	2021-06-24 12:49:33	15,28
1788	2021-06-24 12:49:35	15,28
1789	2021-06-24 12:49:37	15,28
1790	2021-06-24 12:49:39	15,28
1791	2021-06-24 12:49:41	15,28
1792	2021-06-24 12:49:43	15,28
1793	2021-06-24 12:49:45	15,28
1794	2021-06-24 12:49:47	15,28
1795	2021-06-24 12:49:49	15,28
1796	2021-06-24 12:50:23	15,28
1797	2021-06-24 12:50:25	15,28
1798	2021-06-24 12:50:33	15,28
1799	2021-06-24 12:50:35	15,28
1800	2021-06-24 12:50:37	15,33

1801	2021-06-24 12:50:39	15,33
1802	2021-06-24 12:50:41	15,33
1803	2021-06-24 12:50:43	15,33
1804	2021-06-24 12:50:45	15,33
1805	2021-06-24 12:50:56	15,28
1806	2021-06-24 12:50:58	15,28
1807	2021-06-24 12:51:00	15,28
1808	2021-06-24 12:51:02	15,28
1809	2021-06-24 12:51:04	15,28
1810	2021-06-24 12:51:06	15,28
1811	2021-06-24 12:51:08	15,33
1812	2021-06-24 12:51:10	15,33
1813	2021-06-24 12:51:12	15,33
1814	2021-06-24 12:51:14	15,33
1815	2021-06-24 12:51:16	15,33
1816	2021-06-24 12:51:18	15,33
1817	2021-06-24 12:51:20	15,33
1818	2021-06-24 12:51:22	15,33
1819	2021-06-24 12:51:24	15,33
1820	2021-06-24 12:51:26	15,33
1821	2021-06-24 12:51:30	15,33
1822	2021-06-24 12:51:32	15,33
1823	2021-06-24 12:51:34	15,33
1824	2021-06-24 12:51:41	15,33
1825	2021-06-24 12:51:43	15,33
1826	2021-06-24 12:51:45	15,33
1827	2021-06-24 12:51:47	15,33
1828	2021-06-24 12:51:49	15,33
1829	2021-06-24 12:51:51	15,33
1830	2021-06-24 12:51:53	15,33
1831	2021-06-24 12:51:55	15,33
1832	2021-06-24 12:51:57	15,33
1833	2021-06-24 12:51:59	15,33
1834	2021-06-24 12:52:01	15,33
1835	2021-06-24 12:52:03	15,33
1836	2021-06-24 12:52:05	15,33
1837	2021-06-24 12:52:07	15,33
1838	2021-06-24 12:52:09	15,33
1839	2021-06-24 12:52:11	15,33
1840	2021-06-24 12:52:13	15,33
1841	2021-06-24 12:52:15	15,33
1842	2021-06-24 12:52:17	15,33

1843	2021-06-24 12:52:19	15,39
1844	2021-06-24 12:52:50	15,44
1845	2021-06-24 12:53:18	15,44
1846	2021-06-24 12:53:20	15,50
1847	2021-06-24 12:53:26	15,50
1848	2021-06-24 12:53:34	15,50
1849	2021-06-24 12:53:36	15,50
1850	2021-06-24 12:53:40	15,50
1851	2021-06-24 12:53:42	15,50
1852	2021-06-24 12:53:44	15,50
1853	2021-06-24 12:53:46	15,50
1854	2021-06-24 12:53:55	15,50
1855	2021-06-24 12:53:57	15,50
1856	2021-06-24 12:54:17	15,50
1857	2021-06-24 12:54:19	15,50
1858	2021-06-24 12:54:21	15,50
1859	2021-06-24 12:54:23	15,50
1860	2021-06-24 12:54:25	15,50
1861	2021-06-24 12:54:27	15,50
1862	2021-06-24 12:54:29	15,50
1863	2021-06-24 12:54:48	15,50
1864	2021-06-24 12:54:50	15,50
1865	2021-06-24 12:54:52	15,50
1866	2021-06-24 12:54:54	15,50
1867	2021-06-24 12:55:19	15,56
1868	2021-06-24 12:55:36	15,56
1869	2021-06-24 12:55:38	15,56
1870	2021-06-24 12:55:48	15,56
1871	2021-06-24 12:55:50	15,56
1872	2021-06-24 12:55:52	15,56
1873	2021-06-24 12:55:54	15,56
1874	2021-06-24 12:55:56	15,56
1875	2021-06-24 12:56:02	15,56
1876	2021-06-24 12:56:04	15,56
1877	2021-06-24 12:56:11	15,56
1878	2021-06-24 12:56:13	15,56
1879	2021-06-24 12:56:23	15,56
1880	2021-06-24 12:56:25	15,56
1881	2021-06-24 12:56:27	15,56
1882	2021-06-24 12:56:37	15,56
1883	2021-06-24 12:56:39	15,56
1884	2021-06-24 12:56:41	15,56

1885	2021-06-24 12:56:43	15,56
1886	2021-06-24 12:56:45	15,56
1887	2021-06-24 12:56:49	15,56
1888	2021-06-24 12:56:56	15,56
1889	2021-06-24 12:56:58	15,56
1890	2021-06-24 12:57:08	15,61
1891	2021-06-24 12:57:10	15,61
1892	2021-06-24 12:57:14	15,61
1893	2021-06-24 12:57:22	15,56
1894	2021-06-24 12:57:26	15,56
1895	2021-06-24 12:57:28	15,56
1896	2021-06-24 12:57:30	15,56
1897	2021-06-24 12:57:40	15,56
1898	2021-06-24 12:57:42	15,56
1899	2021-06-24 12:57:44	15,56
1900	2021-06-24 12:57:46	15,61
1901	2021-06-24 12:57:48	15,61
1902	2021-06-24 12:58:08	15,61
1903	2021-06-24 12:58:10	15,61
1904	2021-06-24 12:58:31	15,56
1905	2021-06-24 12:58:33	15,56
1906	2021-06-24 12:58:39	15,61
1907	2021-06-24 12:58:41	15,61
1908	2021-06-24 12:58:43	15,61
1909	2021-06-24 12:58:45	15,61
1910	2021-06-24 12:58:47	15,61
1911	2021-06-24 12:58:49	15,61
1912	2021-06-24 12:58:57	15,61
1913	2021-06-24 12:59:03	15,61
1914	2021-06-24 13:00:10	15,56
1915	2021-06-24 13:00:12	15,56
1916	2021-06-24 13:00:14	15,56
1917	2021-06-24 13:00:16	15,56
1918	2021-06-24 13:00:18	15,56
1919	2021-06-24 13:00:28	15,56
1920	2021-06-24 13:00:30	15,56
1921	2021-06-24 13:00:32	15,56
1922	2021-06-24 13:00:34	15,56
1923	2021-06-24 13:00:41	15,50
1924	2021-06-24 13:00:43	15,50
1925	2021-06-24 13:00:45	15,50
1926	2021-06-24 13:00:47	15,50

1927	2021-06-24 13:00:49	15,50
1928	2021-06-24 13:00:51	15,50
1929	2021-06-24 13:00:55	15,56
1930	2021-06-24 13:00:57	15,56
1931	2021-06-24 13:00:59	15,56
1932	2021-06-24 13:01:09	15,56
1933	2021-06-24 13:01:11	15,56
1934	2021-06-24 13:01:15	15,56
1935	2021-06-24 13:01:17	15,56
1936	2021-06-24 13:01:19	15,56
1937	2021-06-24 13:01:34	15,56
1938	2021-06-24 13:01:36	15,56
1939	2021-06-24 13:01:58	15,56
1940	2021-06-24 13:02:04	15,56
1941	2021-06-24 13:03:13	15,50
1942	2021-06-24 13:03:19	15,50
1943	2021-06-24 13:03:21	15,50
1944	2021-06-24 13:03:29	15,50
1945	2021-06-24 13:03:51	15,44
1946	2021-06-24 13:03:53	15,44
1947	2021-06-24 13:03:55	15,44
1948	2021-06-24 13:03:57	15,44
1949	2021-06-24 13:04:17	15,44
1950	2021-06-24 13:04:19	15,44
1951	2021-06-24 13:05:35	15,39
1952	2021-06-24 13:06:08	15,33
1953	2021-06-24 13:06:10	15,39
1954	2021-06-24 13:06:12	15,39
1955	2021-06-24 13:06:14	15,39
1956	2021-06-24 13:06:16	15,39
1957	2021-06-24 13:06:18	15,39
1958	2021-06-24 13:06:20	15,39
1959	2021-06-24 13:06:22	15,39
1960	2021-06-24 13:06:24	15,39
1961	2021-06-24 13:06:26	15,39
1962	2021-06-24 13:06:28	15,39
1963	2021-06-24 13:06:30	15,33
1964	2021-06-24 13:06:32	15,33
1965	2021-06-24 13:06:34	15,33
1966	2021-06-24 13:06:51	15,39
1967	2021-06-24 13:07:01	15,33
1968	2021-06-24 13:07:35	15,33

1969	2021-06-24 13:07:37	15,33
1970	2021-06-24 13:07:39	15,33
1971	2021-06-24 13:07:41	15,33
1972	2021-06-24 13:07:43	15,33
1973	2021-06-24 13:07:53	15,33
1974	2021-06-24 13:07:55	15,33
1975	2021-06-24 13:07:57	15,33
1976	2021-06-24 13:07:59	15,33
1977	2021-06-24 13:08:14	15,33
1978	2021-06-24 13:08:16	15,33
1979	2021-06-24 13:08:22	15,39
1980	2021-06-24 13:08:24	15,39
1981	2021-06-24 13:08:26	15,39
1982	2021-06-24 13:08:28	15,39
1983	2021-06-24 13:08:30	15,39
1984	2021-06-24 13:08:32	15,39
1985	2021-06-24 13:08:34	15,39
1986	2021-06-24 13:08:36	15,39
1987	2021-06-24 13:08:40	15,39
1988	2021-06-24 13:08:48	15,39
1989	2021-06-24 13:09:06	15,39
1990	2021-06-24 13:09:08	15,39
1991	2021-06-24 13:09:18	15,39
1992	2021-06-24 13:09:20	15,39
1993	2021-06-24 13:09:22	15,39
1994	2021-06-24 13:09:24	15,39
1995	2021-06-24 13:09:26	15,39
1996	2021-06-24 13:09:28	15,39
1997	2021-06-24 13:09:30	15,39
1998	2021-06-24 13:09:32	15,39
1999	2021-06-24 13:09:41	15,39
2000	2021-06-24 13:09:43	15,39
2001	2021-06-24 13:09:45	15,39
2002	2021-06-24 13:09:47	15,39
2003	2021-06-24 13:09:49	15,39
2004	2021-06-24 13:09:51	15,39
2005	2021-06-24 13:09:55	15,39
2006	2021-06-24 13:09:57	15,39
2007	2021-06-24 13:09:59	15,39
2008	2021-06-24 13:10:01	15,39
2009	2021-06-24 13:10:03	15,39
2010	2021-06-24 13:10:05	15,39

2011	2021-06-24 13:10:07	15,39
2012	2021-06-24 13:10:19	15,39
2013	2021-06-24 13:10:26	15,39
2014	2021-06-24 13:10:28	15,39
2015	2021-06-24 13:10:30	15,39
2016	2021-06-24 13:10:32	15,39
2017	2021-06-24 13:10:38	15,44
2018	2021-06-24 13:10:40	15,44
2019	2021-06-24 13:10:42	15,44
2020	2021-06-24 13:10:44	15,44
2021	2021-06-24 13:10:46	15,39
2022	2021-06-24 13:10:48	15,39
2023	2021-06-24 13:10:50	15,39
2024	2021-06-24 13:10:52	15,39
2025	2021-06-24 13:12:08	15,44
2026	2021-06-24 13:12:10	15,44
2027	2021-06-24 13:12:12	15,44
2028	2021-06-24 13:12:14	15,44
2029	2021-06-24 13:12:20	15,44
2030	2021-06-24 13:12:22	15,44
2031	2021-06-24 13:12:24	15,44
2032	2021-06-24 13:12:26	15,44
2033	2021-06-24 13:12:28	15,44
2034	2021-06-24 13:12:46	15,50
2035	2021-06-24 13:12:52	15,56
2036	2021-06-24 13:12:54	15,56
2037	2021-06-24 13:12:56	15,56
2038	2021-06-24 13:12:58	15,56
2039	2021-06-24 13:13:00	15,50
2040	2021-06-24 13:13:06	15,50
2041	2021-06-24 13:13:08	15,50
2042	2021-06-24 13:13:12	15,50
2043	2021-06-24 13:13:14	15,50
2044	2021-06-24 13:13:16	15,50
2045	2021-06-24 13:13:26	15,50
2046	2021-06-24 13:13:28	15,50
2047	2021-06-24 13:13:30	15,50
2048	2021-06-24 13:13:32	15,50
2049	2021-06-24 13:13:34	15,50
2050	2021-06-24 13:13:44	15,56
2051	2021-06-24 13:13:46	15,56
2052	2021-06-24 13:13:50	15,56

2053	2021-06-24 13:13:52	15,50
2054	2021-06-24 13:13:54	15,50
2055	2021-06-24 13:13:56	15,50
2056	2021-06-24 13:14:02	15,50
2057	2021-06-24 13:14:04	15,50
2058	2021-06-24 13:14:19	15,50
2059	2021-06-24 13:14:21	15,50
2060	2021-06-24 13:14:23	15,50
2061	2021-06-24 13:14:25	15,50
2062	2021-06-24 13:14:27	15,50
2063	2021-06-24 13:14:29	15,50
2064	2021-06-24 13:14:31	15,50
2065	2021-06-24 13:14:33	15,44
2066	2021-06-24 13:14:37	15,44
2067	2021-06-24 13:14:39	15,44
2068	2021-06-24 13:14:45	15,44
2069	2021-06-24 13:14:47	15,44
2070	2021-06-24 13:14:49	15,44
2071	2021-06-24 13:14:56	15,50
2072	2021-06-24 13:14:58	15,50
2073	2021-06-24 13:15:00	15,50
2074	2021-06-24 13:15:02	15,50
2075	2021-06-24 13:15:04	15,50
2076	2021-06-24 13:15:06	15,50
2077	2021-06-24 13:15:08	15,50
2078	2021-06-24 13:15:10	15,50
2079	2021-06-24 13:15:24	15,44
2080	2021-06-24 13:15:26	15,44
2081	2021-06-24 13:16:05	15,50
2082	2021-06-24 13:16:13	15,50
2083	2021-06-24 13:16:15	15,44
2084	2021-06-24 13:16:26	15,44
2085	2021-06-24 13:16:28	15,44
2086	2021-06-24 13:16:30	15,44
2087	2021-06-24 13:16:32	15,44
2088	2021-06-24 13:16:34	15,44
2089	2021-06-24 13:16:36	15,44
2090	2021-06-24 13:16:38	15,44
2091	2021-06-24 13:16:40	15,44
2092	2021-06-24 13:16:42	15,44
2093	2021-06-24 13:16:44	15,44
2094	2021-06-24 13:16:46	15,44



2095	2021-06-24 13:16:48	15,44
2096	2021-06-24 13:16:50	15,44
2097	2021-06-24 13:16:52	15,44
2098	2021-06-24 13:16:54	15,44
2099	2021-06-24 13:16:56	15,44
2100	2021-06-24 13:17:00	15,44
2101	2021-06-24 13:17:02	15,44
2102	2021-06-24 13:17:04	15,44
2103	2021-06-24 13:17:16	15,44
2104	2021-06-24 13:17:20	15,44
2105	2021-06-24 13:17:22	15,44
2106	2021-06-24 13:17:40	15,44
2107	2021-06-24 13:17:42	15,44
2108	2021-06-24 13:17:44	15,44
2109	2021-06-24 13:17:46	15,39
2110	2021-06-24 13:17:48	15,39
2111	2021-06-24 13:17:55	15,39
2112	2021-06-24 13:17:57	15,39
2113	2021-06-24 13:17:59	15,39
2114	2021-06-24 13:18:01	15,39
2115	2021-06-24 13:18:03	15,39
2116	2021-06-24 13:18:05	15,39
2117	2021-06-24 13:18:07	15,39
2118	2021-06-24 13:18:09	15,39
2119	2021-06-24 13:18:11	15,39
2120	2021-06-24 13:18:13	15,39
2121	2021-06-24 13:18:15	15,39
2122	2021-06-24 13:18:17	15,39
2123	2021-06-24 13:18:20	15,39
2124	2021-06-24 13:18:22	15,39
2125	2021-06-24 13:18:24	15,39
2126	2021-06-24 13:18:26	15,39
2127	2021-06-24 13:18:28	15,39
2128	2021-06-24 13:18:30	15,39
2129	2021-06-24 13:18:32	15,39
2130	2021-06-24 13:18:41	15,33
2131	2021-06-24 13:18:43	15,33
2132	2021-06-24 13:18:45	15,33
2133	2021-06-24 13:18:49	15,33
2134	2021-06-24 13:18:51	15,33
2135	2021-06-24 13:18:53	15,33
2136	2021-06-24 13:18:55	15,33

2137	2021-06-24 13:18:57	15,33
2138	2021-06-24 13:18:59	15,39
2139	2021-06-24 13:19:01	15,39
2140	2021-06-24 13:19:03	15,39
2141	2021-06-24 13:19:05	15,39
2142	2021-06-24 13:19:07	15,39
2143	2021-06-24 13:19:19	15,33
2144	2021-06-24 13:19:26	15,33
2145	2021-06-24 13:19:28	15,33
2146	2021-06-24 13:19:30	15,33
2147	2021-06-24 13:19:32	15,33
2148	2021-06-24 13:19:34	15,33
2149	2021-06-24 13:19:36	15,33
2150	2021-06-24 13:19:38	15,33
2151	2021-06-24 13:19:40	15,33
2152	2021-06-24 13:19:42	15,33
2153	2021-06-24 13:19:44	15,33
2154	2021-06-24 13:19:46	15,33
2155	2021-06-24 13:19:48	15,33
2156	2021-06-24 13:19:50	15,33
2157	2021-06-24 13:19:52	15,33
2158	2021-06-24 13:19:54	15,33
2159	2021-06-24 13:20:11	15,33
2160	2021-06-24 13:20:13	15,33
2161	2021-06-24 13:20:15	15,33
2162	2021-06-24 13:20:17	15,33
2163	2021-06-24 13:20:19	15,33
2164	2021-06-24 13:20:21	15,33
2165	2021-06-24 13:20:23	15,33
2166	2021-06-24 13:20:25	15,33
2167	2021-06-24 13:20:27	15,33
2168	2021-06-24 13:20:29	15,33
2169	2021-06-24 13:20:31	15,33
2170	2021-06-24 13:20:33	15,33
2171	2021-06-24 13:20:35	15,33
2172	2021-06-24 13:20:37	15,33
2173	2021-06-24 13:20:39	15,33
2174	2021-06-24 13:20:41	15,33
2175	2021-06-24 13:20:43	15,33
2176	2021-06-24 13:20:45	15,33
2177	2021-06-24 13:20:56	15,33
2178	2021-06-24 13:20:58	15,33

2179	2021-06-24 13:21:00	15,33
2180	2021-06-24 13:21:02	15,33
2181	2021-06-24 13:21:04	15,33
2182	2021-06-24 13:21:06	15,33
2183	2021-06-24 13:21:08	15,33
2184	2021-06-24 13:21:10	15,33
2185	2021-06-24 13:21:12	15,33
2186	2021-06-24 13:21:14	15,33
2187	2021-06-24 13:21:16	15,33
2188	2021-06-24 13:21:22	15,33
2189	2021-06-24 13:22:09	15,39
2190	2021-06-24 13:22:11	15,39
2191	2021-06-24 13:22:13	15,39
2192	2021-06-24 13:22:15	15,39
2193	2021-06-24 13:22:17	15,39
2194	2021-06-24 13:22:19	15,39
2195	2021-06-24 13:22:39	15,39
2196	2021-06-24 13:23:03	15,39
2197	2021-06-24 13:23:11	15,39
2198	2021-06-24 13:23:13	15,39
2199	2021-06-24 13:23:15	15,44
2200	2021-06-24 13:23:17	15,44
2201	2021-06-24 13:23:19	15,44
2202	2021-06-24 13:23:21	15,44
2203	2021-06-24 13:23:56	15,44
2204	2021-06-24 13:23:58	15,44
2205	2021-06-24 13:24:00	15,44
2206	2021-06-24 13:24:02	15,44
2207	2021-06-24 13:24:04	15,44
2208	2021-06-24 13:24:06	15,44
2209	2021-06-24 13:24:08	15,44
2210	2021-06-24 13:25:15	15,50
2211	2021-06-24 13:25:17	15,50
2212	2021-06-24 13:25:32	15,50
2213	2021-06-24 13:25:34	15,50
2214	2021-06-24 13:25:36	15,50
2215	2021-06-24 13:26:11	15,50
2216	2021-06-24 13:26:13	15,50
2217	2021-06-24 13:26:15	15,50
2218	2021-06-24 13:26:17	15,50
2219	2021-06-24 13:26:19	15,56
2220	2021-06-24 13:26:21	15,56

2221	2021-06-24 13:27:09	15,56
2222	2021-06-24 13:27:15	15,56
2223	2021-06-24 13:27:17	15,56
2224	2021-06-24 13:27:19	15,56
2225	2021-06-24 13:27:21	15,56
2226	2021-06-24 13:27:23	15,56
2227	2021-06-24 13:27:25	15,56
2228	2021-06-24 13:27:27	15,56
2229	2021-06-24 13:27:31	15,56
2230	2021-06-24 13:27:33	15,56
2231	2021-06-24 13:27:51	15,56
2232	2021-06-24 13:27:53	15,56
2233	2021-06-24 13:27:55	15,56
2234	2021-06-24 13:27:57	15,56
2235	2021-06-24 13:28:03	15,56
2236	2021-06-24 13:28:09	15,56
2237	2021-06-24 13:28:11	15,56
2238	2021-06-24 13:28:15	15,56
2239	2021-06-24 13:28:19	15,56
2240	2021-06-24 13:28:26	15,56
2241	2021-06-24 13:28:28	15,56
2242	2021-06-24 13:28:30	15,56
2243	2021-06-24 13:28:32	15,56
2244	2021-06-24 13:28:34	15,61
2245	2021-06-24 13:28:36	15,61
2246	2021-06-24 13:28:38	15,61
2247	2021-06-24 13:28:40	15,61
2248	2021-06-24 13:28:42	15,61
2249	2021-06-24 13:28:46	15,61
2250	2021-06-24 13:28:48	15,61
2251	2021-06-24 13:28:50	15,61
2252	2021-06-24 13:28:52	15,61
2253	2021-06-24 13:28:54	15,61
2254	2021-06-24 13:28:56	15,61
2255	2021-06-24 13:28:58	15,61
2256	2021-06-24 13:29:02	15,61
2257	2021-06-24 13:29:11	15,61
2258	2021-06-24 13:29:13	15,61
2259	2021-06-24 13:29:15	15,61
2260	2021-06-24 13:29:17	15,61
2261	2021-06-24 13:29:19	15,61
2262	2021-06-24 13:29:21	15,61

2263	2021-06-24 13:29:23	15,61
2264	2021-06-24 13:29:25	15,61
2265	2021-06-24 13:29:27	15,61
2266	2021-06-24 13:29:35	15,61
2267	2021-06-24 13:29:37	15,61
2268	2021-06-24 13:29:39	15,61
2269	2021-06-24 13:29:56	15,61
2270	2021-06-24 13:29:58	15,61
2271	2021-06-24 13:30:00	15,61
2272	2021-06-24 13:30:02	15,61
2273	2021-06-24 13:30:04	15,61
2274	2021-06-24 13:30:08	15,61
2275	2021-06-24 13:30:10	15,61
2276	2021-06-24 13:30:14	15,61
2277	2021-06-24 13:30:16	15,61
2278	2021-06-24 13:30:18	15,61
2279	2021-06-24 13:30:20	15,61
2280	2021-06-24 13:30:22	15,61
2281	2021-06-24 13:30:24	15,61
2282	2021-06-24 13:30:26	15,61
2283	2021-06-24 13:30:28	15,61
2284	2021-06-24 13:30:30	15,61
2285	2021-06-24 13:30:34	15,61
2286	2021-06-24 13:30:47	15,61
2287	2021-06-24 13:30:49	15,61
2288	2021-06-24 13:30:53	15,61
2289	2021-06-24 13:30:55	15,61
2290	2021-06-24 13:30:57	15,67
2291	2021-06-24 13:30:59	15,67
2292	2021-06-24 13:31:01	15,67
2293	2021-06-24 13:31:07	15,61
2294	2021-06-24 13:31:11	15,61
2295	2021-06-24 13:31:13	15,61
2296	2021-06-24 13:31:15	15,61
2297	2021-06-24 13:31:17	15,61
2298	2021-06-24 13:31:19	15,61
2299	2021-06-24 13:31:25	15,61
2300	2021-06-24 13:31:27	15,61
2301	2021-06-24 13:31:29	15,61
2302	2021-06-24 13:31:31	15,61
2303	2021-06-24 13:31:33	15,61
2304	2021-06-24 13:31:35	15,61

2305	2021-06-24 13:31:56	15,61
2306	2021-06-24 13:32:10	15,56
2307	2021-06-24 13:32:12	15,56
2308	2021-06-24 13:32:20	15,56
2309	2021-06-24 13:32:22	15,56
2310	2021-06-24 13:32:24	15,56
2311	2021-06-24 13:32:26	15,56
2312	2021-06-24 13:32:40	15,50
2313	2021-06-24 13:32:48	15,50
2314	2021-06-24 13:32:56	15,44
2315	2021-06-24 13:32:58	15,44
2316	2021-06-24 13:33:00	15,44
2317	2021-06-24 13:33:10	15,44
2318	2021-06-24 13:33:12	15,44
2319	2021-06-24 13:33:24	15,44
2320	2021-06-24 13:33:34	15,44
2321	2021-06-24 13:33:41	15,39
2322	2021-06-24 13:33:43	15,39
2323	2021-06-24 13:33:45	15,39
2324	2021-06-24 13:33:51	15,39
2325	2021-06-24 13:33:53	15,39
2326	2021-06-24 13:33:55	15,39
2327	2021-06-24 13:33:57	15,39
2328	2021-06-24 13:33:59	15,39
2329	2021-06-24 13:34:03	15,39
2330	2021-06-24 13:34:05	15,39
2331	2021-06-24 13:34:07	15,39
2332	2021-06-24 13:34:19	15,39
2333	2021-06-24 13:34:30	15,33
2334	2021-06-24 13:34:32	15,33
2335	2021-06-24 13:34:36	15,33
2336	2021-06-24 13:34:48	15,33
2337	2021-06-24 13:34:50	15,33
2338	2021-06-24 13:34:52	15,33
2339	2021-06-24 13:34:54	15,33
2340	2021-06-24 13:34:58	15,33
2341	2021-06-24 13:35:00	15,33
2342	2021-06-24 13:35:15	15,28
2343	2021-06-24 13:35:17	15,28
2344	2021-06-24 13:35:19	15,28
2345	2021-06-24 13:35:31	15,28
2346	2021-06-24 13:35:35	15,28

2347	2021-06-24 13:35:37	15,28
2348	2021-06-24 13:35:41	15,28
2349	2021-06-24 13:35:49	15,28
2350	2021-06-24 13:36:02	15,22
2351	2021-06-24 13:36:04	15,22
2352	2021-06-24 13:36:06	15,22
2353	2021-06-24 13:36:08	15,22
2354	2021-06-24 13:36:10	15,22
2355	2021-06-24 13:36:12	15,22
2356	2021-06-24 13:36:14	15,22
2357	2021-06-24 13:36:44	15,17
2358	2021-06-24 13:36:55	15,11
2359	2021-06-24 13:36:57	15,11
2360	2021-06-24 13:36:59	15,11
2361	2021-06-24 13:37:01	15,11
2362	2021-06-24 13:37:03	15,11
2363	2021-06-24 13:37:09	15,11
2364	2021-06-24 13:37:13	15,11
2365	2021-06-24 13:37:15	15,11
2366	2021-06-24 13:37:17	15,11
2367	24-06-2021 13:37:34	15,11
2368	24-06-2021 13:37:36	15,11
2369	2021-06-24 13:37:38	15,06
2370	24-06-2021 13:37:48	15,06
2371	24-06-2021 13:37:50	15,06
2372	24-06-2021 13:37:52	15,06
2373	24-06-2021 13:37:54	15,06
2374	24-06-2021 13:37:56	15,06
2375	24-06-2021 13:37:58	15,06
2376	24-06-2021 13:38:00	15,06
2377	24-06-2021 13:38:02	15,06
2378	24-06-2021 13:38:04	15,06
2379	2021-06-24 13:38:11	14,94
2380	2021-06-24 13:38:13	14,94
2381	2021-06-24 13:38:15	14,94
2382	2021-06-24 13:38:23	14,94
2383	2021-06-24 13:38:25	14,94
2384	2021-06-24 13:38:27	14,89
2385	2021-06-24 13:38:33	14,89
2386	2021-06-24 13:38:35	14,89
2387	2021-06-24 13:38:37	14,89
2388	2021-06-24 13:38:39	14,89

2389	2021-06-24 13:39:02	14,83
2390	2021-06-24 13:39:14	14,83
2391	2021-06-24 13:39:16	14,83
2392	2021-06-24 13:39:18	14,83
2393	2021-06-24 13:39:22	14,78
2394	2021-06-24 13:39:24	14,78
2395	2021-06-24 13:39:26	14,78
2396	2021-06-24 13:39:28	14,78
2397	2021-06-24 13:39:41	14,78
2398	2021-06-24 13:39:43	14,78
2399	2021-06-24 13:39:45	14,78
2400	2021-06-24 13:39:47	14,78
2401	2021-06-24 13:39:49	14,78
2402	2021-06-24 13:39:55	14,78
2403	2021-06-24 13:39:59	14,78
2404	2021-06-24 13:40:01	14,78
2405	2021-06-24 13:40:05	14,78
2406	2021-06-24 13:40:07	14,78
2407	2021-06-24 13:40:09	14,78
2408	2021-06-24 13:40:11	14,78
2409	2021-06-24 13:40:30	14,72
2410	2021-06-24 13:40:34	14,72
2411	2021-06-24 13:40:42	14,72
2412	2021-06-24 13:40:44	14,72
2413	2021-06-24 13:40:46	14,72
2414	2021-06-24 13:40:48	14,72
2415	2021-06-24 13:40:50	14,67
2416	2021-06-24 13:40:52	14,67
2417	2021-06-24 13:40:54	14,67
2418	2021-06-24 13:40:56	14,67
2419	2021-06-24 13:40:58	14,67
2420	2021-06-24 13:41:00	14,67
2421	2021-06-24 13:41:10	14,67
2422	2021-06-24 13:41:12	14,67
2423	2021-06-24 13:41:14	14,67
2424	2021-06-24 13:41:16	14,67
2425	2021-06-24 13:41:18	14,67
2426	2021-06-24 13:41:20	14,67
2427	2021-06-24 13:41:22	14,67
2428	2021-06-24 13:41:26	14,67
2429	2021-06-24 13:41:30	14,67
2430	2021-06-24 13:41:32	14,67

2431	2021-06-24 13:41:42	14,61
2432	2021-06-24 13:41:44	14,61
2433	2021-06-24 13:41:56	14,67
2434	2021-06-24 13:41:58	14,67
2435	2021-06-24 13:42:00	14,67
2436	2021-06-24 13:42:02	14,67
2437	2021-06-24 13:42:04	14,61
2438	2021-06-24 13:42:06	14,61
2439	2021-06-24 13:42:08	14,61
2440	2021-06-24 13:42:10	14,61
2441	2021-06-24 13:42:12	14,61
2442	2021-06-24 13:42:24	14,61
2443	2021-06-24 13:42:26	14,61
2444	2021-06-24 13:42:28	14,61
2445	2021-06-24 13:42:30	14,61
2446	2021-06-24 13:42:32	14,61
2447	2021-06-24 13:42:34	14,61
2448	2021-06-24 13:42:41	14,61
2449	2021-06-24 13:42:43	14,61
2450	2021-06-24 13:42:45	14,61
2451	2021-06-24 13:42:47	14,61
2452	2021-06-24 13:42:57	14,61
2453	2021-06-24 13:42:59	14,61
2454	2021-06-24 13:43:11	14,61
2455	2021-06-24 13:43:13	14,61
2456	2021-06-24 13:43:26	14,61
2457	2021-06-24 13:43:28	14,61
2458	2021-06-24 13:43:30	14,61
2459	2021-06-24 13:43:32	14,61
2460	2021-06-24 13:43:40	14,61
2461	2021-06-24 13:43:42	14,61
2462	2021-06-24 13:43:44	14,61
2463	2021-06-24 13:43:46	14,61
2464	2021-06-24 13:43:48	14,61
2465	2021-06-24 13:43:50	14,61
2466	2021-06-24 13:43:52	14,61
2467	2021-06-24 13:43:54	14,61
2468	2021-06-24 13:43:56	14,61
2469	2021-06-24 13:44:02	14,61
2470	2021-06-24 13:44:04	14,61
2471	2021-06-24 13:44:11	14,61
2472	2021-06-24 13:44:13	14,61

2473	2021-06-24 13:44:21	14,56
2474	2021-06-24 13:44:23	14,56
2475	2021-06-24 13:44:25	14,56
2476	2021-06-24 13:44:27	14,56
2477	2021-06-24 13:44:29	14,56
2478	2021-06-24 13:44:39	14,56
2479	2021-06-24 13:44:43	14,56
2480	2021-06-24 13:44:45	14,56
2481	2021-06-24 13:44:56	14,56
2482	2021-06-24 13:44:58	14,56
2483	2021-06-24 13:45:00	14,56
2484	2021-06-24 13:45:02	14,56
2485	2021-06-24 13:45:12	14,56
2486	2021-06-24 13:45:14	14,56
2487	2021-06-24 13:45:16	14,61
2488	2021-06-24 13:45:22	14,61
2489	2021-06-24 13:45:24	14,61
2490	2021-06-24 13:45:26	14,56
2491	2021-06-24 13:45:28	14,56
2492	2021-06-24 13:45:30	14,56
2493	2021-06-24 13:45:32	14,56
2494	2021-06-24 13:45:34	14,56
2495	2021-06-24 13:45:41	14,56
2496	2021-06-24 13:45:43	14,56
2497	2021-06-24 13:46:01	14,56
2498	2021-06-24 13:46:09	14,56
2499	2021-06-24 13:46:11	14,56
2500	2021-06-24 13:46:36	14,56
2501	2021-06-24 13:46:38	14,56
2502	2021-06-24 13:46:42	14,50
2503	2021-06-24 13:46:44	14,50
2504	2021-06-24 13:46:46	14,50
2505	2021-06-24 13:46:56	14,50
2506	2021-06-24 13:47:04	14,50
2507	2021-06-24 13:47:11	14,44
2508	2021-06-24 13:47:13	14,44
2509	2021-06-24 13:47:15	14,44
2510	2021-06-24 13:47:25	14,44
2511	2021-06-24 13:47:27	14,44
2512	2021-06-24 13:47:29	14,44
2513	2021-06-24 13:47:33	14,44
2514	2021-06-24 13:47:35	14,44

2515	2021-06-24 13:47:37	14,44
2516	2021-06-24 13:47:39	14,44
2517	2021-06-24 13:47:49	14,44
2518	2021-06-24 13:48:02	14,39
2519	2021-06-24 13:48:04	14,39
2520	2021-06-24 13:48:06	14,39
2521	2021-06-24 13:48:08	14,39
2522	2021-06-24 13:48:10	14,39
2523	2021-06-24 13:48:12	14,39
2524	2021-06-24 13:48:14	14,39
2525	2021-06-24 13:48:16	14,39
2526	2021-06-24 13:48:18	14,39
2527	2021-06-24 13:48:22	14,39
2528	2021-06-24 13:48:24	14,39
2529	2021-06-24 13:48:26	14,39
2530	2021-06-24 13:48:30	14,39
2531	2021-06-24 13:48:32	14,39
2532	2021-06-24 13:48:41	14,39
2533	2021-06-24 13:48:43	14,39
2534	2021-06-24 13:48:45	14,39
2535	2021-06-24 13:48:47	14,39
2536	2021-06-24 13:48:49	14,39
2537	2021-06-24 13:48:51	14,39
2538	2021-06-24 13:48:53	14,33
2539	2021-06-24 13:48:55	14,33
2540	2021-06-24 13:49:07	14,39
2541	2021-06-24 13:49:19	14,39
2542	2021-06-24 13:49:26	14,39
2543	2021-06-24 13:49:28	14,39
2544	2021-06-24 13:49:30	14,39
2545	2021-06-24 13:49:38	14,33
2546	2021-06-24 13:49:40	14,33
2547	2021-06-24 13:49:42	14,33
2548	2021-06-24 13:49:44	14,33
2549	2021-06-24 13:49:46	14,33
2550	2021-06-24 13:49:48	14,33
2551	2021-06-24 13:49:54	14,33
2552	2021-06-24 13:49:56	14,33
2553	2021-06-24 13:50:19	14,28
2554	2021-06-24 13:50:21	14,28
2555	2021-06-24 13:50:27	14,33
2556	2021-06-24 13:50:35	14,28

2557	2021-06-24 13:50:37	14,28
2558	2021-06-24 13:50:39	14,28
2559	2021-06-24 13:50:43	14,28
2560	2021-06-24 13:50:47	14,33
2561	2021-06-24 13:50:49	14,33
2562	2021-06-24 13:51:02	14,28
2563	2021-06-24 13:51:10	14,28
2564	2021-06-24 13:51:18	14,28
2565	2021-06-24 13:51:20	14,28
2566	2021-06-24 13:51:24	14,28
2567	2021-06-24 13:51:26	14,28
2568	2021-06-24 13:51:30	14,22
2569	2021-06-24 13:51:32	14,22
2570	2021-06-24 13:51:41	14,28
2571	2021-06-24 13:51:43	14,28
2572	2021-06-24 13:51:45	14,28
2573	2021-06-24 13:51:49	14,22
2574	2021-06-24 13:51:51	14,22
2575	2021-06-24 13:51:53	14,22
2576	2021-06-24 13:51:55	14,22
2577	2021-06-24 13:52:03	14,22
2578	2021-06-24 13:52:09	14,22
2579	2021-06-24 13:52:11	14,22
2580	2021-06-24 13:52:15	14,22
2581	2021-06-24 13:52:32	14,22
2582	2021-06-24 13:52:40	14,17
2583	2021-06-24 13:52:42	14,17
2584	2021-06-24 13:52:50	14,17
2585	2021-06-24 13:52:54	14,17
2586	2021-06-24 13:53:11	14,17
2587	2021-06-24 13:53:13	14,17
2588	2021-06-24 13:53:15	14,17
2589	2021-06-24 13:53:21	14,11
2590	2021-06-24 13:53:23	14,11
2591	2021-06-24 13:53:25	14,11
2592	2021-06-24 13:53:27	14,11
2593	2021-06-24 13:53:29	14,17
2594	2021-06-24 13:53:31	14,17
2595	2021-06-24 13:53:33	14,17
2596	2021-06-24 13:53:39	14,11
2597	2021-06-24 13:53:41	14,11
2598	2021-06-24 13:53:43	14,11

2599	2021-06-24 13:53:49	14,11
2600	2021-06-24 13:54:02	14,11
2601	2021-06-24 13:54:04	14,11
2602	2021-06-24 13:54:08	14,11
2603	2021-06-24 13:54:10	14,11
2604	2021-06-24 13:54:12	14,11
2605	2021-06-24 13:54:14	14,11
2606	2021-06-24 13:54:16	14,11
2607	2021-06-24 13:54:18	14,11
2608	2021-06-24 13:54:20	14,11
2609	2021-06-24 13:54:32	14,11
2610	2021-06-24 13:54:34	14,11
2611	2021-06-24 13:54:41	14,11
2612	2021-06-24 13:54:43	14,11
2613	2021-06-24 13:54:45	14,11
2614	2021-06-24 13:54:47	14,11
2615	2021-06-24 13:54:49	14,11
2616	2021-06-24 13:54:51	14,11
2617	2021-06-24 13:54:59	14,11
2618	2021-06-24 13:55:01	14,11
2619	2021-06-24 13:55:03	14,11
2620	2021-06-24 13:55:05	14,11
2621	2021-06-24 13:55:09	14,11
2622	2021-06-24 13:55:15	14,06
2623	2021-06-24 13:55:19	14,06
2624	2021-06-24 13:55:27	14,11
2625	2021-06-24 13:55:29	14,11
2626	2021-06-24 13:55:31	14,11
2627	2021-06-24 13:55:35	14,11
2628	2021-06-24 13:55:39	14,11
2629	2021-06-24 13:55:41	14,11
2630	2021-06-24 13:55:45	14,11
2631	2021-06-24 13:55:55	14,06
2632	2021-06-24 13:56:03	14,06
2633	2021-06-24 13:56:05	14,06
2634	2021-06-24 13:56:11	14,06
2635	2021-06-24 13:56:13	14,06
2636	2021-06-24 13:56:19	14,06
2637	2021-06-24 13:56:33	14,06
2638	2021-06-24 13:56:35	14,06
2639	2021-06-24 13:57:00	14,06
2640	2021-06-24 13:57:02	14,06

2641	2021-06-24 13:57:04	14,06
2642	2021-06-24 13:57:06	14,06
2643	2021-06-24 13:57:16	14,06
2644	2021-06-24 13:57:22	14,06
2645	2021-06-24 13:57:30	14,06
2646	2021-06-24 13:57:32	14,06
2647	2021-06-24 13:57:49	14,00
2648	2021-06-24 13:57:53	14,00
2649	2021-06-24 13:57:59	14,00
2650	2021-06-24 13:58:03	14,00
2651	2021-06-24 13:58:13	14,00
2652	2021-06-24 13:58:15	14,00
2653	2021-06-24 13:58:19	14,00
2654	2021-06-24 13:58:26	14,00
2655	2021-06-24 13:58:28	14,00
2656	2021-06-24 13:58:30	14,00
2657	2021-06-24 13:58:32	14,00
2658	2021-06-24 13:58:34	14,00
2659	2021-06-24 13:58:36	14,00
2660	2021-06-24 13:58:38	14,00
2661	2021-06-24 13:58:50	13,94
2662	2021-06-24 13:58:52	13,94
2663	2021-06-24 13:58:54	13,94
2664	2021-06-24 13:58:58	14,00
2665	2021-06-24 13:59:15	14,00
2666	2021-06-24 13:59:17	13,94
2667	2021-06-24 13:59:19	13,94
2668	2021-06-24 13:59:27	13,94
2669	2021-06-24 13:59:29	13,94
2670	2021-06-24 13:59:31	13,94
2671	2021-06-24 13:59:39	13,94
2672	2021-06-24 13:59:43	13,94
2673	2021-06-24 14:00:02	13,94
2674	2021-06-24 14:00:08	13,94
2675	2021-06-24 14:00:10	13,94
2676	2021-06-24 14:00:12	13,94
2677	2021-06-24 14:00:14	13,94
2678	2021-06-24 14:00:16	13,94
2679	2021-06-24 14:00:20	13,89
2680	2021-06-24 14:00:22	13,89
2681	2021-06-24 14:00:24	13,89
2682	2021-06-24 14:00:26	13,89

2683	2021-06-24 14:00:28	13,89
2684	2021-06-24 14:00:30	13,89
2685	2021-06-24 14:00:32	13,89
2686	2021-06-24 14:00:53	13,89
2687	2021-06-24 14:00:55	13,89
2688	2021-06-24 14:00:57	13,89
2689	2021-06-24 14:00:59	13,89
2690	2021-06-24 14:01:01	13,89
2691	2021-06-24 14:01:03	13,89
2692	2021-06-24 14:01:05	13,89
2693	2021-06-24 14:01:07	13,89
2694	2021-06-24 14:01:09	13,89
2695	2021-06-24 14:01:11	13,89
2696	2021-06-24 14:01:13	13,89
2697	2021-06-24 14:01:15	13,89
2698	2021-06-24 14:01:17	13,89
2699	2021-06-24 14:01:36	13,83
2700	2021-06-24 14:01:38	13,83
2701	2021-06-24 14:01:40	13,83
2702	2021-06-24 14:01:42	13,83
2703	2021-06-24 14:01:44	13,83
2704	2021-06-24 14:01:46	13,83
2705	2021-06-24 14:01:48	13,83
2706	2021-06-24 14:01:56	13,83
2707	2021-06-24 14:02:04	13,83
2708	2021-06-24 14:02:23	13,83
2709	2021-06-24 14:02:25	13,83
2710	2021-06-24 14:02:27	13,83
2711	2021-06-24 14:02:35	13,83
2712	2021-06-24 14:02:41	13,83
2713	2021-06-24 14:02:45	13,83
2714	2021-06-24 14:02:47	13,83
2715	2021-06-24 14:02:49	13,83
2716	2021-06-24 14:03:06	13,83
2717	2021-06-24 14:03:08	13,83
2718	2021-06-24 14:03:10	13,83
2719	2021-06-24 14:03:12	13,83
2720	2021-06-24 14:03:14	13,83
2721	2021-06-24 14:03:16	13,83
2722	2021-06-24 14:03:18	13,83
2723	2021-06-24 14:03:20	13,83
2724	2021-06-24 14:03:22	13,83

2725	2021-06-24 14:03:24	13,83
2726	2021-06-24 14:03:26	13,83
2727	2021-06-24 14:03:30	13,83
2728	2021-06-24 14:03:41	13,83
2729	2021-06-24 14:03:43	13,83
2730	2021-06-24 14:03:45	13,83
2731	2021-06-24 14:03:47	13,83
2732	2021-06-24 14:03:51	13,83
2733	2021-06-24 14:03:53	13,83
2734	2021-06-24 14:03:55	13,83
2735	2021-06-24 14:03:57	13,83
2736	2021-06-24 14:03:59	13,83
2737	2021-06-24 14:04:01	13,83
2738	2021-06-24 14:04:07	13,83
2739	2021-06-24 14:04:40	13,83
2740	2021-06-24 14:04:42	13,83
2741	2021-06-24 14:04:44	13,83
2742	2021-06-24 14:04:46	13,78
2743	2021-06-24 14:04:48	13,78
2744	2021-06-24 14:04:50	13,78
2745	2021-06-24 14:04:54	13,78
2746	2021-06-24 14:05:02	13,78
2747	2021-06-24 14:05:11	13,78
2748	2021-06-24 14:05:13	13,78
2749	2021-06-24 14:05:15	13,78
2750	2021-06-24 14:05:25	13,83
2751	2021-06-24 14:05:27	13,83
2752	2021-06-24 14:05:29	13,83
2753	2021-06-24 14:05:35	13,83
2754	2021-06-24 14:05:43	13,83
2755	2021-06-24 14:05:45	13,83
2756	2021-06-24 14:05:49	13,83
2757	2021-06-24 14:06:02	13,78
2758	2021-06-24 14:06:06	13,78
2759	2021-06-24 14:06:08	13,78
2760	2021-06-24 14:06:10	13,78
2761	2021-06-24 14:06:14	13,78
2762	2021-06-24 14:06:20	13,78
2763	2021-06-24 14:06:22	13,78
2764	2021-06-24 14:06:30	13,78
2765	2021-06-24 14:06:34	13,78
2766	2021-06-24 14:06:41	13,78



2767	2021-06-24 14:06:43	13,78
2768	2021-06-24 14:06:45	13,78
2769	2021-06-24 14:06:47	13,78
2770	2021-06-24 14:06:53	13,78
2771	2021-06-24 14:06:55	13,78
2772	2021-06-24 14:07:05	13,78
2773	2021-06-24 14:07:19	13,78
2774	2021-06-24 14:07:25	13,78
2775	2021-06-24 14:07:27	13,78
2776	2021-06-24 14:07:29	13,72
2777	2021-06-24 14:07:31	13,72
2778	2021-06-24 14:07:33	13,72
2779	2021-06-24 14:07:35	13,72
2780	2021-06-24 14:07:37	13,72
2781	2021-06-24 14:07:40	13,72
2782	2021-06-24 14:07:41	13,72
2783	2021-06-24 14:07:44	13,72
2784	2021-06-24 14:07:46	13,72
2785	2021-06-24 14:07:54	13,72
2786	2021-06-24 14:07:56	13,72
2787	2021-06-24 14:08:04	13,72
2788	2021-06-24 14:08:11	13,72
2789	2021-06-24 14:08:13	13,72
2790	2021-06-24 14:08:15	13,72
2791	2021-06-24 14:08:17	13,72
2792	2021-06-24 14:08:19	13,72
2793	2021-06-24 14:08:21	13,72
2794	2021-06-24 14:08:27	13,72
2795	2021-06-24 14:08:29	13,72
2796	2021-06-24 14:08:37	13,72
2797	2021-06-24 14:08:45	13,72
2798	2021-06-24 14:08:47	13,72
2799	2021-06-24 14:09:08	13,72
2800	2021-06-24 14:09:10	13,72
2801	2021-06-24 14:09:12	13,72
2802	2021-06-24 14:09:14	13,72
2803	2021-06-24 14:09:26	13,72
2804	2021-06-24 14:09:34	13,67
2805	2021-06-24 14:09:41	13,72
2806	2021-06-24 14:09:43	13,72
2807	2021-06-24 14:09:59	13,67
2808	2021-06-24 14:10:01	13,67

2809	2021-06-24 14:10:03	13,72
2810	2021-06-24 14:10:05	13,72
2811	2021-06-24 14:10:11	13,72
2812	2021-06-24 14:10:13	13,67
2813	2021-06-24 14:10:15	13,67
2814	2021-06-24 14:10:17	13,67
2815	2021-06-24 14:10:26	13,72
2816	2021-06-24 14:10:28	13,72
2817	2021-06-24 14:10:36	13,67
2818	2021-06-24 14:10:48	13,67
2819	2021-06-24 14:10:50	13,67
2820	2021-06-24 14:10:54	13,67
2821	2021-06-24 14:10:58	13,67
2822	2021-06-24 14:11:00	13,67
2823	2021-06-24 14:11:04	13,67
2824	2021-06-24 14:11:21	13,67
2825	2021-06-24 14:11:23	13,67
2826	2021-06-24 14:11:25	13,67
2827	2021-06-24 14:11:27	13,67
2828	2021-06-24 14:11:29	13,67
2829	2021-06-24 14:11:31	13,67
2830	2021-06-24 14:11:43	13,67
2831	2021-06-24 14:11:45	13,67
2832	2021-06-24 14:11:47	13,67
2833	2021-06-24 14:11:56	13,67
2834	2021-06-24 14:11:58	13,67
2835	2021-06-24 14:12:06	13,67
2836	2021-06-24 14:12:16	13,67
2837	2021-06-24 14:12:20	13,67
2838	2021-06-24 14:12:22	13,67
2839	2021-06-24 14:12:24	13,67
2840	2021-06-24 14:12:26	13,67
2841	2021-06-24 14:12:34	13,67
2842	2021-06-24 14:12:45	13,67
2843	2021-06-24 14:12:47	13,67
2844	2021-06-24 14:12:49	13,67
2845	2021-06-24 14:12:51	13,67
2846	2021-06-24 14:13:09	13,67
2847	2021-06-24 14:13:11	13,67
2848	2021-06-24 14:13:15	13,67
2849	2021-06-24 14:13:17	13,67
2850	2021-06-24 14:13:19	13,67

2851	2021-06-24 14:13:44	13,72
2852	2021-06-24 14:13:46	13,72
2853	2021-06-24 14:13:48	13,72
2854	2021-06-24 14:14:02	13,67
2855	2021-06-24 14:14:04	13,67
2856	2021-06-24 14:14:11	13,67
2857	2021-06-24 14:14:13	13,67
2858	2021-06-24 14:14:15	13,67
2859	2021-06-24 14:14:17	13,67
2860	2021-06-24 14:14:19	13,67
2861	2021-06-24 14:14:21	13,67
2862	2021-06-24 14:14:29	13,67
2863	2021-06-24 14:14:31	13,67
2864	2021-06-24 14:14:33	13,67
2865	2021-06-24 14:14:35	13,67
2866	2021-06-24 14:14:37	13,67
2867	2021-06-24 14:14:39	13,67
2868	2021-06-24 14:14:41	13,72
2869	2021-06-24 14:14:43	13,72
2870	2021-06-24 14:15:00	13,72
2871	2021-06-24 14:15:02	13,72
2872	2021-06-24 14:15:10	13,72
2873	2021-06-24 14:15:12	13,72
2874	2021-06-24 14:15:14	13,72
2875	2021-06-24 14:15:16	13,72
2876	2021-06-24 14:15:41	13,72
2877	2021-06-24 14:15:43	13,72
2878	2021-06-24 14:15:45	13,72
2879	2021-06-24 14:15:47	13,72
2880	2021-06-24 14:15:49	13,72
2881	2021-06-24 14:15:51	13,72
2882	2021-06-24 14:15:53	13,72
2883	2021-06-24 14:15:57	13,72
2884	2021-06-24 14:16:07	13,72
2885	2021-06-24 14:16:09	13,72
2886	2021-06-24 14:16:11	13,72
2887	2021-06-24 14:16:13	13,72
2888	2021-06-24 14:16:15	13,72
2889	2021-06-24 14:16:17	13,72
2890	2021-06-24 14:16:19	13,72
2891	2021-06-24 14:16:56	13,78
2892	2021-06-24 14:16:58	13,78

2893	2021-06-24 14:17:00	13,78
2894	2021-06-24 14:17:02	13,78
2895	2021-06-24 14:17:04	13,78
2896	2021-06-24 14:17:27	13,78
2897	2021-06-24 14:17:29	13,78
2898	2021-06-24 14:17:31	13,78
2899	2021-06-24 14:17:33	13,78
2900	2021-06-24 14:17:35	13,78
2901	2021-06-24 14:17:37	13,78
2902	2021-06-24 14:18:22	13,78
2903	2021-06-24 14:18:24	13,78
2904	2021-06-24 14:18:26	13,78
2905	2021-06-24 14:18:28	13,78
2906	2021-06-24 14:18:30	13,78
2907	2021-06-24 14:18:32	13,78
2908	2021-06-24 14:18:34	13,78
2909	2021-06-24 14:18:41	13,78
2910	2021-06-24 14:18:43	13,78
2911	2021-06-24 14:18:45	13,78
2912	2021-06-24 14:18:47	13,78
2913	2021-06-24 14:18:51	13,78
2914	2021-06-24 14:18:53	13,78
2915	2021-06-24 14:18:55	13,78
2916	2021-06-24 14:18:59	13,83
2917	2021-06-24 14:19:01	13,83
2918	2021-06-24 14:19:03	13,83
2919	2021-06-24 14:19:05	13,83
2920	2021-06-24 14:19:15	13,83
2921	2021-06-24 14:19:17	13,83
2922	2021-06-24 14:19:19	13,83
2923	2021-06-24 14:19:40	13,83
2924	2021-06-24 14:19:42	13,83
2925	2021-06-24 14:19:44	13,83
2926	2021-06-24 14:19:46	13,83
2927	2021-06-24 14:19:48	13,83
2928	2021-06-24 14:19:50	13,83
2929	2021-06-24 14:19:52	13,83
2930	2021-06-24 14:19:56	13,83
2931	2021-06-24 14:19:58	13,83
2932	2021-06-24 14:20:04	13,83
2933	2021-06-24 14:20:11	13,83
2934	2021-06-24 14:20:13	13,83

2935	2021-06-24 14:20:15	13,83
2936	2021-06-24 14:20:17	13,83
2937	2021-06-24 14:20:23	13,83
2938	2021-06-24 14:20:25	13,83
2939	2021-06-24 14:20:29	13,83
2940	2021-06-24 14:20:31	13,83
2941	2021-06-24 14:20:33	13,83
2942	2021-06-24 14:20:35	13,83
2943	2021-06-24 14:20:37	13,83
2944	2021-06-24 14:20:39	13,83
2945	2021-06-24 14:20:47	13,83
2946	2021-06-24 14:20:49	13,83
2947	2021-06-24 14:21:06	13,83
2948	2021-06-24 14:21:08	13,78
2949	2021-06-24 14:21:10	13,78
2950	2021-06-24 14:21:16	13,78
2951	2021-06-24 14:21:26	13,83
2952	2021-06-24 14:21:28	13,83
2953	2021-06-24 14:21:30	13,78
2954	2021-06-24 14:21:32	13,78
2955	2021-06-24 14:21:45	13,78
2956	2021-06-24 14:21:47	13,78
2957	2021-06-24 14:21:59	13,78
2958	2021-06-24 14:22:01	13,78
2959	2021-06-24 14:22:07	13,78
2960	2021-06-24 14:22:11	13,72
2961	2021-06-24 14:22:26	13,72
2962	2021-06-24 14:22:28	13,72
2963	2021-06-24 14:22:30	13,72
2964	2021-06-24 14:22:40	13,72
2965	2021-06-24 14:22:46	13,67
2966	2021-06-24 14:22:48	13,67
2967	2021-06-24 14:22:54	13,67
2968	2021-06-24 14:22:56	13,67
2969	2021-06-24 14:23:00	13,67
2970	2021-06-24 14:23:02	13,67
2971	2021-06-24 14:23:04	13,67
2972	2021-06-24 14:23:11	13,67
2973	2021-06-24 14:23:13	13,67
2974	2021-06-24 14:23:17	13,67
2975	2021-06-24 14:23:19	13,67
2976	2021-06-24 14:23:25	13,61

2977	2021-06-24 14:23:27	13,61
2978	2021-06-24 14:23:29	13,61
2979	2021-06-24 14:23:33	13,67
2980	2021-06-24 14:23:35	13,67
2981	2021-06-24 14:23:37	13,67
2982	2021-06-24 14:23:43	13,67
2983	2021-06-24 14:23:45	13,67
2984	2021-06-24 14:23:47	13,67
2985	2021-06-24 14:24:02	13,61
2986	2021-06-24 14:24:08	13,61
2987	2021-06-24 14:24:22	13,61
2988	2021-06-24 14:24:24	13,61
2989	2021-06-24 14:24:26	13,56
2990	2021-06-24 14:24:28	13,56
2991	2021-06-24 14:24:30	13,56
2992	2021-06-24 14:24:32	13,56
2993	2021-06-24 14:24:34	13,56
2994	2021-06-24 14:24:47	13,56
2995	2021-06-24 14:24:49	13,56
2996	2021-06-24 14:24:51	13,56
2997	2021-06-24 14:24:53	13,56
2998	2021-06-24 14:24:57	13,56
2999	2021-06-24 14:24:59	13,56
3000	2021-06-24 14:25:01	13,56
3001	2021-06-24 14:25:03	13,56
3002	2021-06-24 14:25:05	13,56
3003	2021-06-24 14:25:07	13,56
3004	2021-06-24 14:25:09	13,56
3005	2021-06-24 14:25:11	13,56
3006	2021-06-24 14:25:15	13,56
3007	2021-06-24 14:25:17	13,56
3008	2021-06-24 14:25:19	13,56
3009	2021-06-24 14:25:30	13,56
3010	2021-06-24 14:25:32	13,56
3011	2021-06-24 14:25:34	13,56
3012	2021-06-24 14:25:36	13,56
3013	2021-06-24 14:25:40	13,56
3014	2021-06-24 14:25:42	13,56
3015	2021-06-24 14:25:44	13,56
3016	2021-06-24 14:25:56	13,56
3017	2021-06-24 14:26:11	13,56
3018	2021-06-24 14:26:13	13,56

3019	2021-06-24 14:26:15	13,56
3020	2021-06-24 14:26:27	13,56
3021	2021-06-24 14:26:29	13,56
3022	2021-06-24 14:26:31	13,56
3023	2021-06-24 14:26:37	13,56
3024	2021-06-24 14:26:39	13,56
3025	2021-06-24 14:27:04	13,50
3026	2021-06-24 14:27:10	13,50
3027	2021-06-24 14:27:12	13,50
3028	2021-06-24 14:27:14	13,50
3029	2021-06-24 14:27:16	13,50
3030	2021-06-24 14:27:18	13,50
3031	2021-06-24 14:27:20	13,50
3032	2021-06-24 14:27:22	13,50
3033	2021-06-24 14:27:24	13,50
3034	2021-06-24 14:27:26	13,50
3035	2021-06-24 14:27:28	13,50
3036	2021-06-24 14:27:41	13,50
3037	2021-06-24 14:27:43	13,50
3038	2021-06-24 14:27:45	13,50
3039	2021-06-24 14:28:03	13,50
3040	2021-06-24 14:28:07	13,50
3041	2021-06-24 14:28:09	13,50
3042	2021-06-24 14:28:11	13,50
3043	2021-06-24 14:28:15	13,50
3044	2021-06-24 14:28:26	13,50
3045	2021-06-24 14:28:28	13,50
3046	2021-06-24 14:28:30	13,50
3047	2021-06-24 14:28:36	13,50
3048	2021-06-24 14:28:38	13,50
3049	2021-06-24 14:28:42	13,50
3050	2021-06-24 14:28:44	13,50
3051	2021-06-24 14:28:50	13,50
3052	2021-06-24 14:28:54	13,50
3053	2021-06-24 14:28:56	13,50
3054	2021-06-24 14:28:58	13,50
3055	2021-06-24 14:29:00	13,50
3056	2021-06-24 14:29:02	13,50
3057	2021-06-24 14:29:04	13,50
3058	2021-06-24 14:29:19	13,50
3059	2021-06-24 14:29:21	13,50
3060	2021-06-24 14:29:23	13,50

3061	2021-06-24 14:29:29	13,50
3062	2021-06-24 14:29:31	13,44
3063	2021-06-24 14:29:33	13,44
3064	2021-06-24 14:29:35	13,44
3065	2021-06-24 14:29:39	13,44
3066	2021-06-24 14:29:41	13,44
3067	2021-06-24 14:29:43	13,44
3068	2021-06-24 14:29:56	13,44
3069	2021-06-24 14:29:58	13,44
3070	2021-06-24 14:30:02	13,44
3071	2021-06-24 14:30:06	13,44
3072	2021-06-24 14:30:10	13,44
3073	2021-06-24 14:30:12	13,39
3074	2021-06-24 14:30:22	13,44
3075	2021-06-24 14:30:28	13,44
3076	2021-06-24 14:30:32	13,39
3077	2021-06-24 14:30:34	13,39
3078	2021-06-24 14:30:41	13,44
3079	2021-06-24 14:30:43	13,44
3080	2021-06-24 14:30:45	13,44
3081	2021-06-24 14:30:47	13,44
3082	2021-06-24 14:30:49	13,44
3083	2021-06-24 14:30:51	13,44
3084	2021-06-24 14:30:53	13,39
3085	2021-06-24 14:30:55	13,39
3086	2021-06-24 14:30:59	13,39
3087	2021-06-24 14:31:01	13,39
3088	2021-06-24 14:31:03	13,39
3089	2021-06-24 14:31:09	13,44
3090	2021-06-24 14:31:15	13,44
3091	2021-06-24 14:31:17	13,44
3092	2021-06-24 14:31:19	13,44
3093	2021-06-24 14:31:26	13,39
3094	2021-06-24 14:31:28	13,39
3095	2021-06-24 14:31:30	13,39
3096	2021-06-24 14:31:32	13,39
3097	2021-06-24 14:31:42	13,39
3098	2021-06-24 14:31:46	13,39
3099	2021-06-24 14:31:48	13,39
3100	2021-06-24 14:31:50	13,39
3101	2021-06-24 14:31:52	13,39
3102	2021-06-24 14:31:54	13,39

3103	2021-06-24 14:31:56	13,39
3104	2021-06-24 14:31:58	13,39
3105	2021-06-24 14:32:00	13,39
3106	2021-06-24 14:32:02	13,39
3107	2021-06-24 14:32:11	13,39
3108	2021-06-24 14:32:13	13,39
3109	2021-06-24 14:32:15	13,39
3110	2021-06-24 14:32:17	13,39
3111	2021-06-24 14:32:27	13,39
3112	2021-06-24 14:32:29	13,39
3113	2021-06-24 14:32:31	13,39
3114	2021-06-24 14:32:39	13,39
3115	2021-06-24 14:32:41	13,39
3116	2021-06-24 14:32:43	13,39
3117	2021-06-24 14:32:45	13,39
3118	2021-06-24 14:32:47	13,39
3119	2021-06-24 14:32:49	13,39
3120	2021-06-24 14:32:56	13,39
3121	2021-06-24 14:32:58	13,39
3122	2021-06-24 14:33:00	13,39
3123	2021-06-24 14:33:02	13,39
3124	2021-06-24 14:33:04	13,39
3125	2021-06-24 14:33:06	13,39
3126	2021-06-24 14:33:08	13,39
3127	2021-06-24 14:33:14	13,39
3128	2021-06-24 14:33:18	13,39
3129	2021-06-24 14:33:20	13,39
3130	2021-06-24 14:33:22	13,39
3131	2021-06-24 14:33:24	13,39
3132	2021-06-24 14:33:28	13,44
3133	2021-06-24 14:33:30	13,44
3134	2021-06-24 14:33:32	13,44
3135	2021-06-24 14:33:51	13,39
3136	2021-06-24 14:33:53	13,39
3137	2021-06-24 14:33:55	13,39
3138	2021-06-24 14:33:57	13,39
3139	2021-06-24 14:33:59	13,39
3140	2021-06-24 14:34:09	13,39
3141	2021-06-24 14:34:11	13,39
3142	2021-06-24 14:34:26	13,44
3143	2021-06-24 14:34:28	13,44
3144	2021-06-24 14:34:30	13,44

3145	2021-06-24 14:34:32	13,44
3146	2021-06-24 14:34:34	13,44
3147	2021-06-24 14:34:36	13,44
3148	2021-06-24 14:34:38	13,39
3149	2021-06-24 14:34:40	13,39
3150	2021-06-24 14:34:42	13,39
3151	2021-06-24 14:34:44	13,39
3152	2021-06-24 14:34:54	13,44
3153	2021-06-24 14:35:02	13,39
3154	2021-06-24 14:35:04	13,39
3155	2021-06-24 14:35:17	13,39
3156	2021-06-24 14:35:19	13,39
3157	2021-06-24 14:35:21	13,39
3158	2021-06-24 14:35:23	13,39
3159	2021-06-24 14:35:29	13,39
3160	2021-06-24 14:35:43	13,39
3161	2021-06-24 14:35:45	13,39
3162	2021-06-24 14:36:00	13,39
3163	2021-06-24 14:36:02	13,39
3164	2021-06-24 14:36:04	13,39
3165	2021-06-24 14:36:06	13,39
3166	2021-06-24 14:36:08	13,39
3167	2021-06-24 14:36:10	13,39
3168	2021-06-24 14:36:12	13,39
3169	2021-06-24 14:36:14	13,39
3170	2021-06-24 14:36:16	13,39
3171	2021-06-24 14:37:05	13,39
3172	2021-06-24 14:37:07	13,39
3173	2021-06-24 14:37:09	13,39
3174	2021-06-24 14:37:15	13,39
3175	2021-06-24 14:37:17	13,39
3176	2021-06-24 14:37:26	13,39
3177	2021-06-24 14:37:28	13,39
3178	2021-06-24 14:37:30	13,39
3179	2021-06-24 14:37:38	13,39
3180	2021-06-24 14:37:40	13,39
3181	2021-06-24 14:37:42	13,39
3182	2021-06-24 14:37:44	13,39
3183	2021-06-24 14:37:46	13,39
3184	2021-06-24 14:37:48	13,39
3185	2021-06-24 14:38:00	13,39
3186	2021-06-24 14:38:02	13,39

3187	2021-06-24 14:38:04	13,39
3188	2021-06-24 14:38:11	13,39
3189	2021-06-24 14:38:13	13,39
3190	2021-06-24 14:38:15	13,39
3191	2021-06-24 14:38:17	13,39
3192	2021-06-24 14:38:19	13,39
3193	2021-06-24 14:38:21	13,39
3194	2021-06-24 14:38:23	13,39
3195	2021-06-24 14:38:25	13,39
3196	2021-06-24 14:38:27	13,39
3197	2021-06-24 14:38:29	13,39
3198	2021-06-24 14:38:31	13,39
3199	2021-06-24 14:38:33	13,39
3200	2021-06-24 14:38:43	13,39
3201	2021-06-24 14:38:45	13,39
3202	2021-06-24 14:39:00	13,39
3203	2021-06-24 14:39:04	13,39
3204	2021-06-24 14:39:06	13,39
3205	2021-06-24 14:39:08	13,39
3206	2021-06-24 14:39:12	13,39
3207	2021-06-24 14:39:14	13,39
3208	2021-06-24 14:39:18	13,39
3209	2021-06-24 14:39:28	13,39
3210	2021-06-24 14:39:30	13,39
3211	2021-06-24 14:39:32	13,39
3212	2021-06-24 14:39:34	13,39
3213	2021-06-24 14:39:41	13,39
3214	2021-06-24 14:39:43	13,39
3215	2021-06-24 14:39:45	13,39
3216	2021-06-24 14:39:47	13,39
3217	2021-06-24 14:39:55	13,39
3218	2021-06-24 14:40:05	13,39
3219	2021-06-24 14:40:09	13,39
3220	2021-06-24 14:40:11	13,39
3221	2021-06-24 14:40:13	13,39
3222	2021-06-24 14:40:32	13,33
3223	2021-06-24 14:40:38	13,33
3224	2021-06-24 14:40:42	13,33
3225	2021-06-24 14:40:44	13,33
3226	2021-06-24 14:40:46	13,33
3227	2021-06-24 14:40:50	13,33
3228	2021-06-24 14:40:52	13,33

3229	2021-06-24 14:40:54	13,33
3230	2021-06-24 14:40:56	13,33
3231	2021-06-24 14:40:58	13,33
3232	2021-06-24 14:41:00	13,33
3233	2021-06-24 14:41:02	13,33
3234	2021-06-24 14:41:04	13,33
3235	2021-06-24 14:41:31	13,33
3236	2021-06-24 14:41:33	13,33
3237	2021-06-24 14:41:37	13,33
3238	2021-06-24 14:41:39	13,33
3239	2021-06-24 14:41:41	13,33
3240	2021-06-24 14:41:43	13,33
3241	2021-06-24 14:41:45	13,33
3242	2021-06-24 14:41:47	13,33
3243	2021-06-24 14:41:49	13,33
3244	2021-06-24 14:41:56	13,33
3245	2021-06-24 14:41:58	13,33
3246	2021-06-24 14:42:00	13,33
3247	2021-06-24 14:42:02	13,33
3248	2021-06-24 14:42:04	13,33
3249	2021-06-24 14:42:08	13,33
3250	2021-06-24 14:42:10	13,33
3251	2021-06-24 14:42:14	13,33
3252	2021-06-24 14:42:16	13,33
3253	2021-06-24 14:42:18	13,33
3254	2021-06-24 14:42:20	13,33
3255	2021-06-24 14:42:24	13,33
3256	2021-06-24 14:42:26	13,33
3257	2021-06-24 14:42:28	13,33
3258	2021-06-24 14:42:30	13,33
3259	2021-06-24 14:42:32	13,33
3260	2021-06-24 14:42:47	13,33
3261	2021-06-24 14:42:49	13,33
3262	2021-06-24 14:42:51	13,33
3263	2021-06-24 14:42:53	13,33
3264	2021-06-24 14:42:55	13,33
3265	2021-06-24 14:42:57	13,33
3266	2021-06-24 14:42:59	13,33
3267	2021-06-24 14:43:01	13,33
3268	2021-06-24 14:43:03	13,33
3269	2021-06-24 14:43:05	13,33
3270	2021-06-24 14:43:07	13,33

3271	2021-06-24 14:43:09	13,33
3272	2021-06-24 14:43:11	13,33
3273	2021-06-24 14:43:13	13,33
3274	2021-06-24 14:43:19	13,33
3275	2021-06-24 14:43:26	13,33
3276	2021-06-24 14:43:28	13,33
3277	2021-06-24 14:43:30	13,33
3278	2021-06-24 14:43:32	13,33
3279	2021-06-24 14:43:46	13,33
3280	2021-06-24 14:43:56	13,33
3281	2021-06-24 14:43:58	13,33
3282	2021-06-24 14:44:00	13,33
3283	2021-06-24 14:44:15	13,33
3284	2021-06-24 14:44:17	13,33
3285	2021-06-24 14:44:21	13,33
3286	2021-06-24 14:44:23	13,33
3287	2021-06-24 14:44:25	13,33
3288	2021-06-24 14:44:33	13,33
3289	2021-06-24 14:44:35	13,33
3290	2021-06-24 14:44:37	13,33
3291	2021-06-24 14:44:41	13,33
3292	2021-06-24 14:44:43	13,33
3293	2021-06-24 14:44:47	13,33
3294	2021-06-24 14:44:56	13,33
3295	2021-06-24 14:44:58	13,33
3296	2021-06-24 14:45:00	13,33
3297	2021-06-24 14:45:04	13,33
3298	2021-06-24 14:45:22	13,33
3299	2021-06-24 14:45:24	13,33
3300	2021-06-24 14:45:30	13,33
3301	2021-06-24 14:45:41	13,39
3302	2021-06-24 14:45:43	13,39
3303	2021-06-24 14:45:49	13,33
3304	2021-06-24 14:45:53	13,33
3305	2021-06-24 14:46:03	13,33
3306	2021-06-24 14:46:05	13,33
3307	2021-06-24 14:46:07	13,33
3308	2021-06-24 14:46:09	13,33
3309	2021-06-24 14:46:11	13,33
3310	2021-06-24 14:46:13	13,33
3311	2021-06-24 14:46:15	13,33
3312	2021-06-24 14:46:26	13,33

3313	2021-06-24 14:46:28	13,33
3314	2021-06-24 14:46:30	13,33
3315	2021-06-24 14:46:32	13,33
3316	2021-06-24 14:46:34	13,33
3317	2021-06-24 14:46:36	13,33
3318	2021-06-24 14:46:44	13,33
3319	2021-06-24 14:46:58	13,33
3320	2021-06-24 14:47:00	13,33
3321	2021-06-24 14:47:02	13,33
3322	2021-06-24 14:47:04	13,33
3323	2021-06-24 14:47:11	13,33
3324	2021-06-24 14:47:13	13,33
3325	2021-06-24 14:47:15	13,33
3326	2021-06-24 14:47:17	13,33
3327	2021-06-24 14:47:19	13,33
3328	2021-06-24 14:47:21	13,33
3329	2021-06-24 14:47:29	13,33
3330	2021-06-24 14:47:31	13,33
3331	2021-06-24 14:47:33	13,33
3332	2021-06-24 14:47:43	13,33
3333	2021-06-24 14:47:45	13,33
3334	2021-06-24 14:47:49	13,33
3335	2021-06-24 14:48:28	13,33
3336	2021-06-24 14:48:30	13,28
3337	2021-06-24 14:48:32	13,28
3338	2021-06-24 14:48:41	13,33
3339	2021-06-24 14:48:43	13,33
3340	2021-06-24 14:48:47	13,33
3341	2021-06-24 14:48:49	13,33
3342	2021-06-24 14:48:53	13,33
3343	2021-06-24 14:48:55	13,33
3344	2021-06-24 14:48:57	13,33
3345	2021-06-24 14:48:59	13,33
3346	2021-06-24 14:49:01	13,33
3347	2021-06-24 14:49:03	13,33
3348	2021-06-24 14:49:05	13,33
3349	2021-06-24 14:49:07	13,33
3350	2021-06-24 14:49:09	13,33
3351	2021-06-24 14:49:13	13,28
3352	2021-06-24 14:49:15	13,28
3353	2021-06-24 14:49:17	13,28
3354	2021-06-24 14:49:19	13,28

3355	2021-06-24 14:49:26	13,33
3356	2021-06-24 14:49:28	13,33
3357	2021-06-24 14:49:40	13,33
3358	2021-06-24 14:49:42	13,33
3359	2021-06-24 14:49:44	13,33
3360	2021-06-24 14:49:46	13,33
3361	2021-06-24 14:49:48	13,33
3362	2021-06-24 14:50:00	13,33
3363	2021-06-24 14:50:02	13,33
3364	2021-06-24 14:50:11	13,28
3365	2021-06-24 14:50:13	13,28
3366	2021-06-24 14:50:15	13,28
3367	2021-06-24 14:50:17	13,28
3368	2021-06-24 14:50:19	13,28
3369	2021-06-24 14:50:21	13,28
3370	2021-06-24 14:50:23	13,28
3371	2021-06-24 14:50:25	13,28
3372	2021-06-24 14:50:27	13,28
3373	2021-06-24 14:50:29	13,28
3374	2021-06-24 14:50:33	13,33
3375	2021-06-24 14:50:37	13,33
3376	2021-06-24 14:50:39	13,33
3377	2021-06-24 14:50:41	13,33
3378	2021-06-24 14:50:49	13,33
3379	2021-06-24 14:51:04	13,28
3380	2021-06-24 14:51:06	13,28
3381	2021-06-24 14:51:08	13,28
3382	2021-06-24 14:51:14	13,28
3383	2021-06-24 14:51:16	13,28
3384	2021-06-24 14:51:18	13,28
3385	2021-06-24 14:51:20	13,28
3386	2021-06-24 14:51:24	13,33
3387	2021-06-24 14:51:26	13,33
3388	2021-06-24 14:51:30	13,33
3389	2021-06-24 14:51:47	13,28
3390	2021-06-24 14:51:57	13,28
3391	2021-06-24 14:51:59	13,28
3392	2021-06-24 14:52:01	13,28
3393	2021-06-24 14:52:03	13,28
3394	2021-06-24 14:52:05	13,28
3395	2021-06-24 14:52:07	13,28
3396	2021-06-24 14:52:17	13,28

3397	2021-06-24 14:52:19	13,28
3398	2021-06-24 14:52:26	13,28
3399	2021-06-24 14:52:28	13,28
3400	2021-06-24 14:52:30	13,28
3401	2021-06-24 14:52:34	13,28
3402	2021-06-24 14:52:44	13,28
3403	2021-06-24 14:52:52	13,28
3404	2021-06-24 14:52:54	13,28
3405	2021-06-24 14:52:56	13,28
3406	2021-06-24 14:52:58	13,28
3407	2021-06-24 14:53:04	13,28
3408	2021-06-24 14:53:11	13,22
3409	2021-06-24 14:53:13	13,22
3410	2021-06-24 14:53:15	13,22
3411	2021-06-24 14:53:17	13,28
3412	2021-06-24 14:53:19	13,28
3413	2021-06-24 14:53:29	13,22
3414	2021-06-24 14:53:31	13,22
3415	2021-06-24 14:53:35	13,22
3416	2021-06-24 14:53:49	13,28
3417	2021-06-24 14:53:56	13,28
3418	2021-06-24 14:53:58	13,28
3419	2021-06-24 14:54:00	13,28
3420	2021-06-24 14:54:02	13,28
3421	2021-06-24 14:54:04	13,28
3422	2021-06-24 14:54:06	13,28
3423	2021-06-24 14:54:14	13,28
3424	2021-06-24 14:54:16	13,28
3425	2021-06-24 14:54:18	13,28
3426	2021-06-24 14:54:20	13,28
3427	2021-06-24 14:54:22	13,28
3428	2021-06-24 14:54:24	13,28
3429	2021-06-24 14:54:26	13,28
3430	2021-06-24 14:54:28	13,28
3431	2021-06-24 14:54:32	13,28
3432	2021-06-24 14:54:34	13,28
3433	2021-06-24 14:54:49	13,22
3434	2021-06-24 14:54:51	13,22
3435	2021-06-24 14:54:53	13,22
3436	2021-06-24 14:55:01	13,28
3437	2021-06-24 14:55:03	13,28
3438	2021-06-24 14:55:05	13,28



3439	2021-06-24 14:55:15	13,28
3440	2021-06-24 14:55:17	13,28
3441	2021-06-24 14:56:02	13,28
3442	2021-06-24 14:56:19	13,22
3443	2021-06-24 14:56:21	13,28
3444	2021-06-24 14:56:23	13,28
3445	2021-06-24 14:56:25	13,28
3446	2021-06-24 14:56:27	13,28
3447	2021-06-24 14:56:29	13,28
3448	2021-06-24 14:56:31	13,28
3449	2021-06-24 14:56:33	13,28
3450	2021-06-24 14:56:35	13,28
3451	2021-06-24 14:56:37	13,28
3452	2021-06-24 14:56:41	13,28
3453	2021-06-24 14:56:43	13,28
3454	2021-06-24 14:56:49	13,28
3455	2021-06-24 14:57:04	13,22
3456	2021-06-24 14:57:06	13,22
3457	2021-06-24 14:57:08	13,22
3458	2021-06-24 14:57:16	13,22
3459	2021-06-24 14:57:18	13,22
3460	2021-06-24 14:57:20	13,22
3461	2021-06-24 14:57:28	13,22
3462	2021-06-24 14:57:30	13,22
3463	2021-06-24 14:57:34	13,22
3464	2021-06-24 14:57:41	13,22
3465	2021-06-24 14:57:43	13,22
3466	2021-06-24 14:57:49	13,22
3467	2021-06-24 14:57:53	13,22
3468	2021-06-24 14:57:55	13,22
3469	2021-06-24 14:57:57	13,22
3470	2021-06-24 14:58:11	13,22
3471	2021-06-24 14:58:19	13,22
3472	2021-06-24 14:58:30	13,22
3473	2021-06-24 14:58:32	13,22
3474	2021-06-24 14:58:34	13,22
3475	2021-06-24 14:58:38	13,22
3476	2021-06-24 14:58:40	13,22
3477	2021-06-24 14:58:48	13,22
3478	2021-06-24 14:58:50	13,22
3479	2021-06-24 14:58:54	13,22
3480	2021-06-24 14:58:56	13,22

3481	2021-06-24 14:58:58	13,22
3482	2021-06-24 14:59:00	13,22
3483	2021-06-24 14:59:11	13,22
3484	2021-06-24 14:59:13	13,22
3485	2021-06-24 14:59:15	13,17
3486	2021-06-24 14:59:21	13,17
3487	2021-06-24 14:59:23	13,17
3488	2021-06-24 14:59:25	13,22
3489	2021-06-24 14:59:27	13,22
3490	2021-06-24 14:59:29	13,22
3491	2021-06-24 14:59:31	13,22
3492	2021-06-24 14:59:47	13,17
3493	2021-06-24 14:59:49	13,17
3494	2021-06-24 15:00:04	13,17
3495	2021-06-24 15:00:06	13,17
3496	2021-06-24 15:00:20	13,17
3497	2021-06-24 15:00:22	13,17
3498	2021-06-24 15:00:24	13,17
3499	2021-06-24 15:00:26	13,17
3500	2021-06-24 15:00:32	13,17
3501	2021-06-24 15:00:34	13,17
3502	2021-06-24 15:00:41	13,17
3503	2021-06-24 15:00:43	13,17
3504	2021-06-24 15:00:47	13,17
3505	2021-06-24 15:00:49	13,17
3506	2021-06-24 15:00:57	13,17
3507	2021-06-24 15:00:59	13,17
3508	2021-06-24 15:01:01	13,17
3509	2021-06-24 15:01:15	13,17
3510	2021-06-24 15:01:17	13,17
3511	2021-06-24 15:01:26	13,17
3512	2021-06-24 15:01:28	13,17
3513	2021-06-24 15:01:30	13,17
3514	2021-06-24 15:01:34	13,17
3515	2021-06-24 15:01:36	13,17
3516	2021-06-24 15:01:40	13,17
3517	2021-06-24 15:01:42	13,17
3518	2021-06-24 15:01:44	13,17
3519	2021-06-24 15:01:46	13,17
3520	2021-06-24 15:01:48	13,17
3521	2021-06-24 15:01:50	13,17
3522	2021-06-24 15:01:56	13,17

3523	2021-06-24 15:01:58	13,17
3524	2021-06-24 15:02:11	13,17
3525	2021-06-24 15:02:13	13,17
3526	2021-06-24 15:02:15	13,17
3527	2021-06-24 15:02:17	13,17
3528	2021-06-24 15:02:19	13,17
3529	2021-06-24 15:02:21	13,17
3530	2021-06-24 15:02:25	13,17
3531	2021-06-24 15:02:27	13,17
3532	2021-06-24 15:02:29	13,17
3533	2021-06-24 15:02:37	13,17
3534	2021-06-24 15:02:39	13,17
3535	2021-06-24 15:02:41	13,17
3536	2021-06-24 15:02:43	13,17
3537	2021-06-24 15:02:45	13,17
3538	2021-06-24 15:02:47	13,17
3539	2021-06-24 15:02:49	13,17
3540	2021-06-24 15:02:56	13,17
3541	2021-06-24 15:02:58	13,17
3542	2021-06-24 15:03:00	13,17
3543	2021-06-24 15:03:02	13,17
3544	2021-06-24 15:03:04	13,17
3545	2021-06-24 15:03:06	13,17
3546	2021-06-24 15:03:08	13,17
3547	2021-06-24 15:03:12	13,17
3548	2021-06-24 15:03:14	13,17
3549	2021-06-24 15:03:57	13,17
3550	2021-06-24 15:04:05	13,17
3551	2021-06-24 15:04:07	13,17
3552	2021-06-24 15:04:09	13,17
3553	2021-06-24 15:04:11	13,17
3554	2021-06-24 15:04:17	13,17
3555	2021-06-24 15:04:19	13,17
3556	2021-06-24 15:04:26	13,17
3557	2021-06-24 15:04:28	13,17
3558	2021-06-24 15:04:30	13,17
3559	2021-06-24 15:04:32	13,17
3560	2021-06-24 15:04:40	13,17
3561	2021-06-24 15:04:42	13,17
3562	2021-06-24 15:04:48	13,17
3563	2021-06-24 15:04:50	13,17
3564	2021-06-24 15:04:52	13,17

3565	2021-06-24 15:04:54	13,17
3566	2021-06-24 15:04:56	13,17
3567	2021-06-24 15:05:02	13,17
3568	2021-06-24 15:05:04	13,17
3569	2021-06-24 15:05:19	13,17
3570	2021-06-24 15:05:21	13,17
3571	2021-06-24 15:05:23	13,17
3572	2021-06-24 15:05:35	13,17
3573	2021-06-24 15:05:37	13,17
3574	2021-06-24 15:05:39	13,17
3575	2021-06-24 15:05:41	13,17
3576	2021-06-24 15:05:49	13,17
3577	2021-06-24 15:05:56	13,22
3578	2021-06-24 15:05:58	13,22
3579	2021-06-24 15:06:00	13,22
3580	2021-06-24 15:06:12	13,22
3581	2021-06-24 15:06:14	13,22
3582	2021-06-24 15:06:16	13,17
3583	2021-06-24 15:06:18	13,17
3584	2021-06-24 15:06:22	13,17
3585	2021-06-24 15:06:26	13,17
3586	2021-06-24 15:06:28	13,17
3587	2021-06-24 15:06:30	13,17
3588	2021-06-24 15:06:32	13,17
3589	2021-06-24 15:06:34	13,17
3590	2021-06-24 15:06:41	13,17
3591	2021-06-24 15:06:43	13,17
3592	2021-06-24 15:06:45	13,17
3593	2021-06-24 15:06:57	13,22
3594	2021-06-24 15:06:59	13,22
3595	2021-06-24 15:07:01	13,22
3596	2021-06-24 15:07:03	13,22
3597	2021-06-24 15:07:05	13,22
3598	2021-06-24 15:07:07	13,17
3599	2021-06-24 15:07:09	13,17
3600	2021-06-24 15:07:11	13,17
3601	2021-06-24 15:07:13	13,17
3602	2021-06-24 15:07:17	13,17
3603	2021-06-24 15:07:34	13,17
3604	2021-06-24 15:07:42	13,17
3605	2021-06-24 15:07:46	13,17
3606	2021-06-24 15:07:48	13,17

3607	2021-06-24 15:07:50	13,17
3608	2021-06-24 15:07:58	13,17
3609	2021-06-24 15:08:00	13,17
3610	2021-06-24 15:08:02	13,17
3611	2021-06-24 15:08:11	13,17
3612	2021-06-24 15:08:13	13,17
3613	2021-06-24 15:08:15	13,17
3614	2021-06-24 15:08:17	13,17
3615	2021-06-24 15:08:19	13,17
3616	2021-06-24 15:08:21	13,17
3617	2021-06-24 15:08:23	13,17
3618	2021-06-24 15:08:25	13,17
3619	2021-06-24 15:08:27	13,17
3620	2021-06-24 15:08:29	13,17
3621	2021-06-24 15:08:33	13,17
3622	2021-06-24 15:08:35	13,17
3623	2021-06-24 15:08:37	13,17
3624	2021-06-24 15:08:45	13,17
3625	2021-06-24 15:08:47	13,17
3626	2021-06-24 15:08:49	13,17
3627	2021-06-24 15:08:56	13,11
3628	2021-06-24 15:08:58	13,11
3629	2021-06-24 15:09:00	13,11
3630	2021-06-24 15:09:04	13,11
3631	2021-06-24 15:09:06	13,11
3632	2021-06-24 15:09:14	13,11
3633	2021-06-24 15:09:22	13,11
3634	2021-06-24 15:09:26	13,11
3635	2021-06-24 15:09:28	13,11
3636	2021-06-24 15:09:30	13,11
3637	2021-06-24 15:09:41	13,06
3638	2021-06-24 15:09:43	13,06
3639	2021-06-24 15:09:45	13,06
3640	2021-06-24 15:09:47	13,06
3641	2021-06-24 15:09:49	13,06
3642	2021-06-24 15:09:51	13,11
3643	2021-06-24 15:09:53	13,11
3644	2021-06-24 15:09:55	13,11
3645	2021-06-24 15:09:57	13,11
3646	2021-06-24 15:09:59	13,11
3647	2021-06-24 15:10:01	13,06
3648	2021-06-24 15:10:03	13,06

3649	2021-06-24 15:10:05	13,06
3650	2021-06-24 15:10:09	13,06
3651	2021-06-24 15:10:11	13,06
3652	2021-06-24 15:10:19	13,06
3653	2021-06-24 15:10:26	13,06
3654	2021-06-24 15:10:28	13,06
3655	2021-06-24 15:10:30	13,06
3656	2021-06-24 15:10:32	13,06
3657	2021-06-24 15:10:34	13,06
3658	2021-06-24 15:10:36	13,06
3659	2021-06-24 15:11:04	13,06
3660	2021-06-24 15:11:11	13,06
3661	2021-06-24 15:11:13	13,06
3662	2021-06-24 15:11:15	13,06
3663	2021-06-24 15:11:17	13,06
3664	2021-06-24 15:11:19	13,06
3665	2021-06-24 15:11:21	13,06
3666	2021-06-24 15:11:43	13,06
3667	2021-06-24 15:11:45	13,06
3668	2021-06-24 15:11:47	13,06
3669	2021-06-24 15:11:49	13,06
3670	2021-06-24 15:11:56	13,06
3671	2021-06-24 15:11:58	13,06
3672	2021-06-24 15:12:00	13,06
3673	2021-06-24 15:12:02	13,06
3674	2021-06-24 15:12:04	13,06
3675	2021-06-24 15:12:06	13,06
3676	2021-06-24 15:12:18	13,06
3677	2021-06-24 15:12:20	13,06
3678	2021-06-24 15:12:22	13,06
3679	2021-06-24 15:12:24	13,06
3680	2021-06-24 15:12:26	13,06
3681	2021-06-24 15:12:53	13,06
3682	2021-06-24 15:12:57	13,06
3683	2021-06-24 15:12:59	13,06
3684	2021-06-24 15:13:01	13,06
3685	2021-06-24 15:13:03	13,06
3686	2021-06-24 15:13:13	13,06
3687	2021-06-24 15:13:15	13,06
3688	2021-06-24 15:13:17	13,06
3689	2021-06-24 15:13:19	13,06
3690	2021-06-24 15:13:26	13,06

3691	2021-06-24 15:13:28	13,06
3692	2021-06-24 15:13:30	13,06
3693	2021-06-24 15:13:32	13,06
3694	2021-06-24 15:13:34	13,06
3695	2021-06-24 15:13:36	13,06
3696	2021-06-24 15:13:38	13,06
3697	2021-06-24 15:13:40	13,06
3698	2021-06-24 15:13:42	13,06
3699	2021-06-24 15:13:46	13,06
3700	2021-06-24 15:13:48	13,06
3701	2021-06-24 15:13:50	13,06
3702	2021-06-24 15:13:52	13,06
3703	2021-06-24 15:13:56	13,06
3704	2021-06-24 15:14:04	13,06
3705	2021-06-24 15:14:31	13,06
3706	2021-06-24 15:14:37	13,06
3707	2021-06-24 15:14:39	13,06
3708	2021-06-24 15:14:45	13,06
3709	2021-06-24 15:14:47	13,06
3710	2021-06-24 15:14:56	13,06
3711	2021-06-24 15:14:58	13,06
3712	2021-06-24 15:15:00	13,06
3713	2021-06-24 15:15:02	13,06
3714	2021-06-24 15:15:04	13,06
3715	2021-06-24 15:15:06	13,06
3716	2021-06-24 15:15:08	13,06
3717	2021-06-24 15:15:18	13,06
3718	2021-06-24 15:15:20	13,06
3719	2021-06-24 15:15:22	13,06
3720	2021-06-24 15:15:24	13,06
3721	2021-06-24 15:15:26	13,06
3722	2021-06-24 15:15:28	13,06
3723	2021-06-24 15:15:30	13,06
3724	2021-06-24 15:15:32	13,06
3725	2021-06-24 15:15:34	13,06
3726	2021-06-24 15:15:41	13,06
3727	2021-06-24 15:15:43	13,06
3728	2021-06-24 15:15:45	13,06
3729	2021-06-24 15:15:47	13,06
3730	2021-06-24 15:15:49	13,06
3731	2021-06-24 15:15:51	13,06
3732	2021-06-24 15:15:53	13,06



3733	2021-06-24 15:15:55	13,06
3734	2021-06-24 15:15:57	13,06
3735	2021-06-24 15:16:07	13,06
3736	2021-06-24 15:16:11	13,06
3737	2021-06-24 15:16:15	13,06
3738	2021-06-24 15:16:42	13,06
3739	2021-06-24 15:16:50	13,06
3740	2021-06-24 15:16:58	13,06
3741	2021-06-24 15:17:00	13,06
3742	2021-06-24 15:17:02	13,00
3743	2021-06-24 15:17:04	13,00
3744	2021-06-24 15:17:11	13,06
3745	2021-06-24 15:17:13	13,06
3746	2021-06-24 15:17:15	13,06
3747	2021-06-24 15:17:17	13,06
3748	2021-06-24 15:17:19	13,06
3749	2021-06-24 15:17:21	13,00
3750	2021-06-24 15:17:23	13,00
3751	2021-06-24 15:17:25	13,00
3752	2021-06-24 15:17:27	13,00
3753	2021-06-24 15:17:29	13,00
3754	2021-06-24 15:17:31	13,00
3755	2021-06-24 15:17:33	13,00
3756	2021-06-24 15:17:47	13,06
3757	2021-06-24 15:17:49	13,06
3758	2021-06-24 15:17:56	13,06
3759	2021-06-24 15:17:58	13,06
3760	2021-06-24 15:18:00	13,06
3761	2021-06-24 15:18:02	13,06
3762	2021-06-24 15:18:08	13,06
3763	2021-06-24 15:18:10	13,06
3764	2021-06-24 15:18:12	13,06
3765	2021-06-24 15:18:14	13,06
3766	2021-06-24 15:18:16	13,06
3767	2021-06-24 15:18:18	13,06
3768	2021-06-24 15:18:20	13,06
3769	2021-06-24 15:18:22	13,06
3770	2021-06-24 15:18:28	13,06
3771	2021-06-24 15:18:30	13,06
3772	2021-06-24 15:18:32	13,06
3773	2021-06-24 15:18:34	13,06
3774	2021-06-24 15:18:41	13,06

3775	2021-06-24 15:18:43	13,06
3776	2021-06-24 15:18:45	13,06
3777	2021-06-24 15:18:47	13,06
3778	2021-06-24 15:18:49	13,06
3779	2021-06-24 15:18:51	13,06
3780	2021-06-24 15:18:53	13,06
3781	2021-06-24 15:18:55	13,06
3782	2021-06-24 15:18:57	13,06
3783	2021-06-24 15:18:59	13,06
3784	2021-06-24 15:19:01	13,06
3785	2021-06-24 15:19:03	13,06
3786	2021-06-24 15:19:05	13,00
3787	2021-06-24 15:19:07	13,00
3788	2021-06-24 15:20:11	13,06
3789	2021-06-24 15:20:13	13,06
3790	2021-06-24 15:20:15	13,06
3791	2021-06-24 15:20:17	13,06
3792	2021-06-24 15:20:21	13,06
3793	2021-06-24 15:20:23	13,06
3794	2021-06-24 15:20:25	13,06
3795	2021-06-24 15:20:27	13,06
3796	2021-06-24 15:20:29	13,06
3797	2021-06-24 15:20:31	13,06
3798	2021-06-24 15:20:33	13,06
3799	2021-06-24 15:20:35	13,06
3800	2021-06-24 15:20:37	13,06
3801	2021-06-24 15:20:39	13,06
3802	2021-06-24 15:20:41	13,06
3803	2021-06-24 15:20:43	13,06
3804	2021-06-24 15:20:45	13,06
3805	2021-06-24 15:20:47	13,06
3806	2021-06-24 15:20:49	13,06
3807	2021-06-24 15:20:56	13,06
3808	2021-06-24 15:20:58	13,06
3809	2021-06-24 15:21:00	13,06
3810	2021-06-24 15:21:02	13,06
3811	2021-06-24 15:21:04	13,06
3812	2021-06-24 15:21:06	13,06
3813	2021-06-24 15:21:08	13,06
3814	2021-06-24 15:21:32	13,06
3815	2021-06-24 15:21:34	13,06
3816	2021-06-24 15:21:41	13,06

3817	2021-06-24 15:21:43	13,06
3818	2021-06-24 15:21:45	13,06
3819	2021-06-24 15:21:47	13,06
3820	2021-06-24 15:21:49	13,06
3821	2021-06-24 15:21:53	13,06
3822	2021-06-24 15:21:55	13,06
3823	2021-06-24 15:21:57	13,06
3824	2021-06-24 15:21:59	13,06
3825	2021-06-24 15:22:01	13,06
3826	2021-06-24 15:22:11	13,06
3827	2021-06-24 15:22:13	13,06
3828	2021-06-24 15:22:15	13,06
3829	2021-06-24 15:22:17	13,06
3830	2021-06-24 15:22:19	13,06
3831	2021-06-24 15:22:26	13,06
3832	2021-06-24 15:22:28	13,06
3833	2021-06-24 15:22:30	13,06
3834	2021-06-24 15:22:32	13,06
3835	2021-06-24 15:22:34	13,06
3836	2021-06-24 15:22:36	13,06
3837	2021-06-24 15:22:38	13,06
3838	2021-06-24 15:22:40	13,06
3839	2021-06-24 15:22:44	13,06
3840	2021-06-24 15:22:46	13,06
3841	2021-06-24 15:22:48	13,06
3842	2021-06-24 15:22:50	13,06
3843	2021-06-24 15:22:52	13,06
3844	2021-06-24 15:22:54	13,06
3845	2021-06-24 15:22:56	13,06
3846	2021-06-24 15:22:58	13,06
3847	2021-06-24 15:23:00	13,06
3848	2021-06-24 15:23:02	13,06
3849	2021-06-24 15:23:04	13,06
3850	2021-06-24 15:23:11	13,06
3851	2021-06-24 15:23:13	13,06
3852	2021-06-24 15:23:29	13,06
3853	2021-06-24 15:23:31	13,06
3854	2021-06-24 15:23:33	13,06
3855	2021-06-24 15:23:35	13,06
3856	2021-06-24 15:23:37	13,06
3857	2021-06-24 15:23:39	13,06
3858	2021-06-24 15:23:41	13,00

3859	2021-06-24 15:23:43	13,00
3860	2021-06-24 15:23:45	13,00
3861	2021-06-24 15:23:47	13,00
3862	2021-06-24 15:23:49	13,00
3863	2021-06-24 15:24:00	13,06
3864	2021-06-24 15:24:02	13,06
3865	2021-06-24 15:24:04	13,06
3866	2021-06-24 15:24:06	13,06
3867	2021-06-24 15:24:24	13,06
3868	2021-06-24 15:24:28	13,06
3869	2021-06-24 15:24:30	13,06
3870	2021-06-24 15:24:32	13,06
3871	2021-06-24 15:24:34	13,06
3872	2021-06-24 15:24:41	13,06
3873	2021-06-24 15:24:43	13,06
3874	2021-06-24 15:24:45	13,06
3875	2021-06-24 15:24:55	13,06
3876	2021-06-24 15:25:05	13,06
3877	2021-06-24 15:25:07	13,06
3878	2021-06-24 15:26:33	13,00
3879	2021-06-24 15:26:35	13,00
3880	2021-06-24 15:26:37	13,00
3881	2021-06-24 15:26:39	13,00
3882	2021-06-24 15:26:41	13,00
3883	2021-06-24 15:26:43	13,00
3884	2021-06-24 15:26:45	13,06
3885	2021-06-24 15:26:47	13,06
3886	2021-06-24 15:26:49	13,06
3887	2021-06-24 15:27:14	13,00
3888	2021-06-24 15:27:16	13,00
3889	2021-06-24 15:27:22	13,00
3890	2021-06-24 15:27:24	13,00
3891	2021-06-24 15:27:26	13,00
3892	2021-06-24 15:27:28	13,00
3893	2021-06-24 15:27:30	13,00
3894	2021-06-24 15:27:32	13,00
3895	2021-06-24 15:27:34	13,00
3896	2021-06-24 15:27:57	13,00
3897	2021-06-24 15:27:59	13,00
3898	2021-06-24 15:28:01	13,00
3899	2021-06-24 15:28:03	13,00
3900	2021-06-24 15:28:05	13,00

3901	2021-06-24 15:28:07	13,00
3902	2021-06-24 15:29:11	13,00
3903	2021-06-24 15:29:13	13,00
3904	2021-06-24 15:29:15	13,00
3905	2021-06-24 15:29:17	13,00
3906	2021-06-24 15:29:19	13,00
3907	2021-06-24 15:29:21	13,00
3908	2021-06-24 15:29:23	13,00
3909	2021-06-24 15:29:25	13,00
3910	2021-06-24 15:29:27	13,00
3911	2021-06-24 15:29:29	13,00
3912	2021-06-24 15:29:31	13,00
3913	2021-06-24 15:29:33	13,00
3914	2021-06-24 15:29:35	13,00
3915	2021-06-24 15:29:37	13,00
3916	2021-06-24 15:29:39	13,00
3917	2021-06-24 15:29:41	13,00
3918	2021-06-24 15:29:43	13,00
3919	2021-06-24 15:29:45	13,00
3920	2021-06-24 15:29:47	13,00
3921	2021-06-24 15:29:49	13,00
3922	2021-06-24 15:29:56	13,06
3923	2021-06-24 15:29:58	13,06
3924	2021-06-24 15:30:00	13,06

	<b>INFORME TÉCNICO DE LA PRUEBA: “POTENCIA MÁXIMA” CENTRAL PLACILLA (revisión 1)</b> Código: PPM-CEN024-2021-CC-DCO-0	
	miércoles 08 septiembre 2021	
Mandante	Revisión 1	Proveedor

## ANEXO G (REGISTRO DE MEDIDORES DE ENERGÍA)

188

Realiza	Francisco Gorigoitia Acuña	Revisa	Patricio Febre Cisternas	Aprueba	Coordinador Eléctrico Nacional
Cargo	Ingeniero de Proyectos	Cargo	Experto Técnico	Cargo	
Firma		Firma		Firma	
Fecha	08/09/2021	Fecha	08/09/2021	Fecha	08/09/2021

G.1 REGISTRO DE POTENCIA EN MEDIDOR DE FACTURACIÓN



Informe de tendencias

24-06-2021 7:00:00 - 24-06-2021 19:00:00 (Local del servidor)			
Tabla de datos del informe			
Fecha y hora	SE_Placilla.Gnr_Placilla_PMG Potencia activa media (kW)	SE_Placilla.Gnr_Placilla_PMG Potencia aparente media (kVA)	SE_Placilla.Gnr_Placilla_PMG Potencia reactiva media (kVAr)
<b>Promedio</b>	<b>-2.387,42</b>	<b>2.457,52</b>	<b>-582,71</b>
24-06-2021 10:30	-2.385,44	2.458,46	-594,67
24-06-2021 10:45	-2.386,93	2.455,94	-578,08
24-06-2021 11:00	-2.385,91	2.458,59	-593,34
24-06-2021 11:15	-2.386,21	2.457,05	-585,62
24-06-2021 11:30	-2.387,63	2.457,46	-581,54
24-06-2021 11:45	-2.388,96	2.458,03	-578,54
24-06-2021 12:00	-2.388,10	2.457,24	-578,76
24-06-2021 12:15	-2.388,13	2.456,96	-577,44
24-06-2021 12:30	-2.389,61	2.458,99	-579,95
24-06-2021 12:45	-2.389,90	2.458,79	-577,90
24-06-2021 13:00	-2.388,53	2.458,52	-582,40
24-06-2021 13:15	-2.387,87	2.457,95	-582,73
24-06-2021 13:30	-2.387,39	2.457,27	-581,77
24-06-2021 13:45	-2.386,63	2.458,29	-589,20
24-06-2021 14:00	-2.386,84	2.458,16	-587,75
24-06-2021 14:15	-2.387,69	2.457,71	-582,36
24-06-2021 14:30	-2.387,15	2.457,40	-583,27
24-06-2021 14:45	-2.386,82	2.457,14	-583,53
24-06-2021 15:00	-2.387,30	2.454,58	-570,73
24-06-2021 15:15	-2.386,48	2.456,82	-583,59
24-06-2021 15:30	-2.386,22	2.456,62	-583,81



G.2 RESPALDO FOTOGRÁFICO DE LAS MEDICIONES DE POTENCIA EN EL MEDIDOR DE FACTURACIÓN

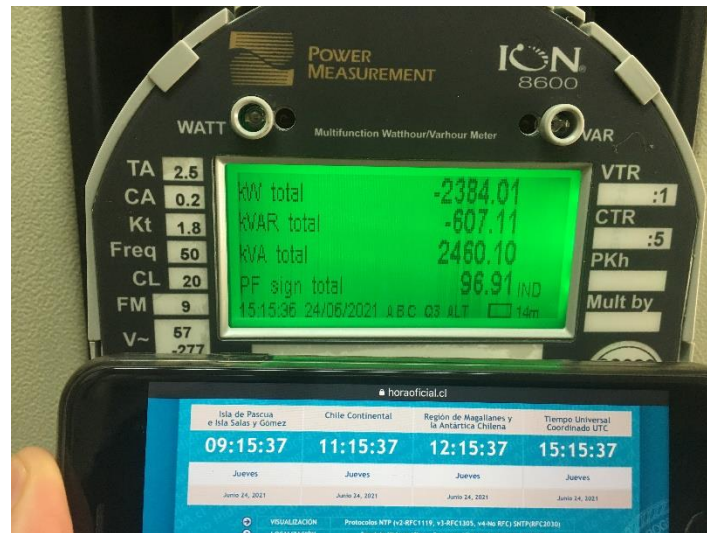
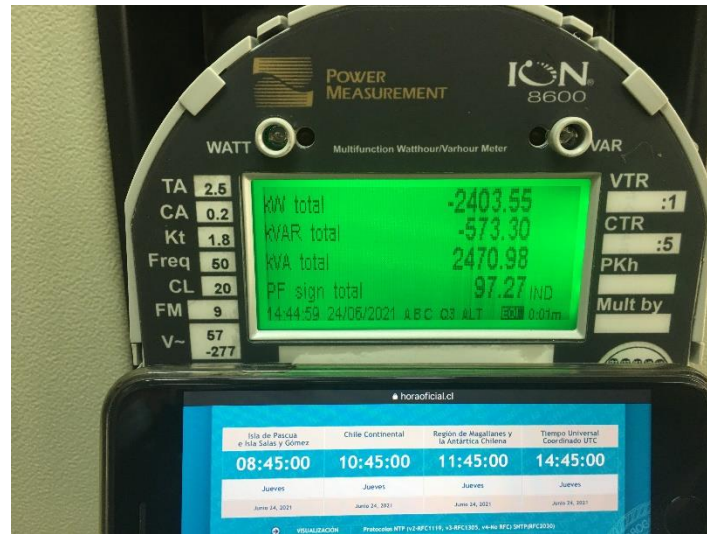
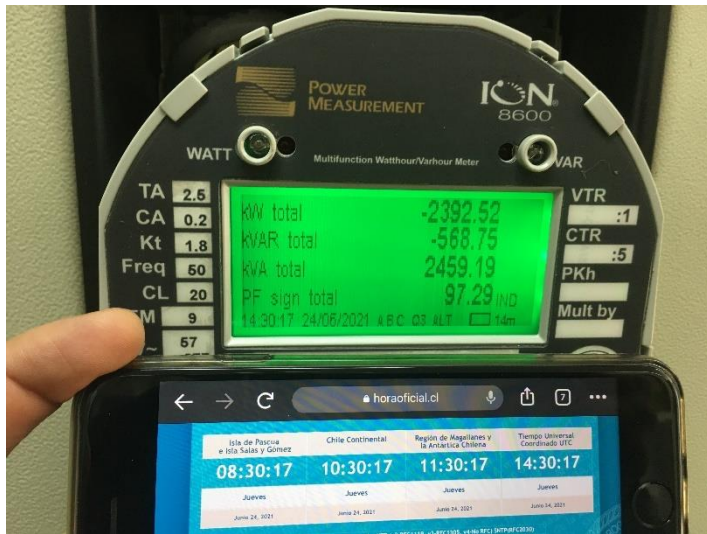

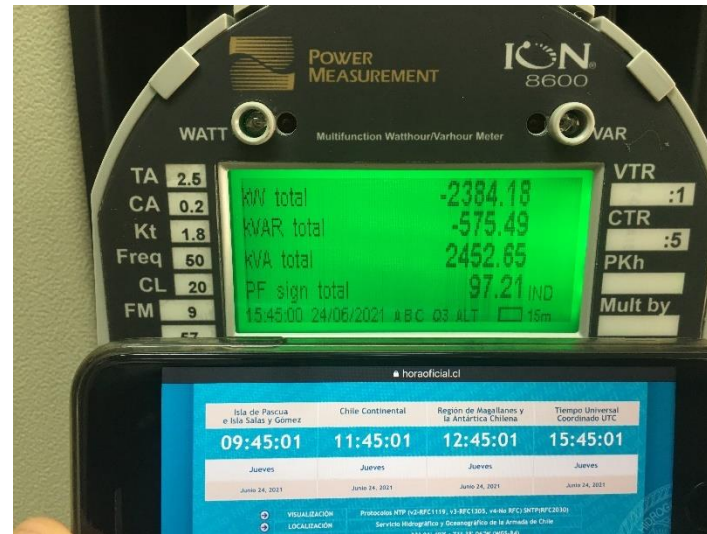

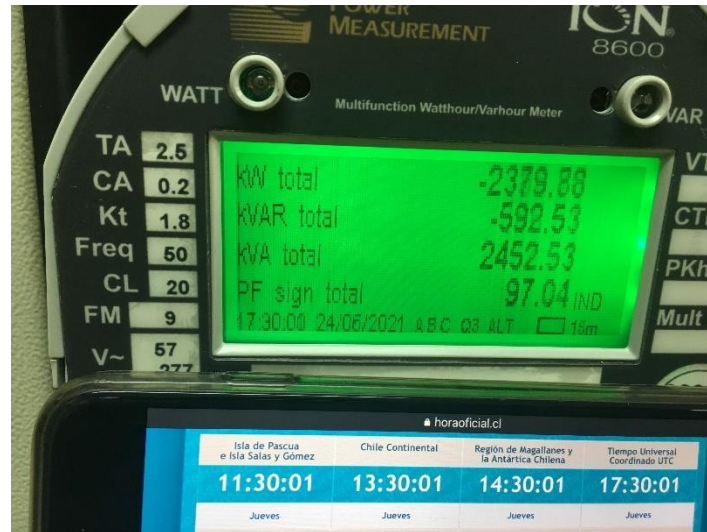

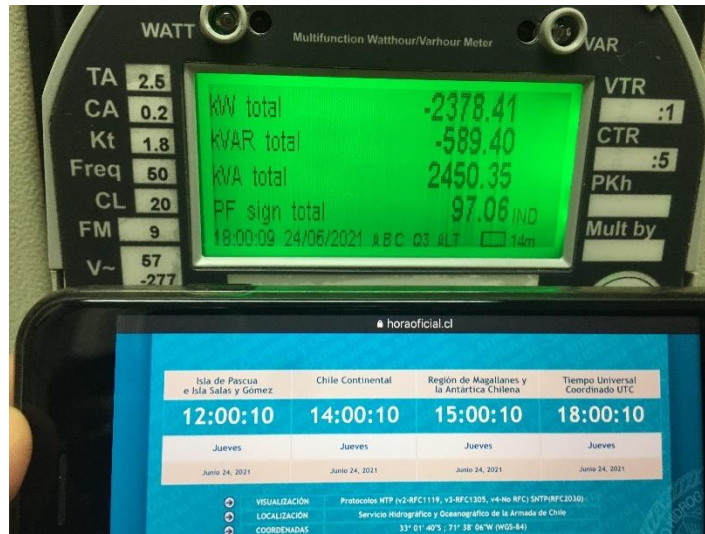

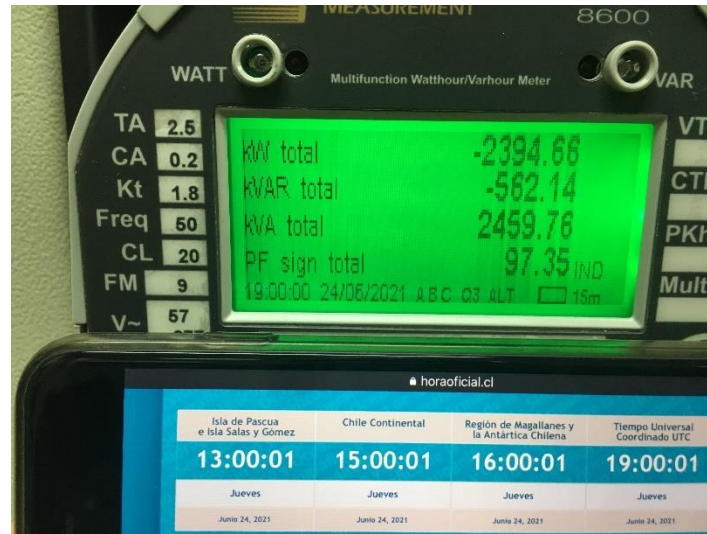

G.3 REGISTRO DE POTENCIA EN MEDIDOR CONECTADO A LOS BORNES DEL GENERADOR DE LA UNIDAD N°2

PROMEDIO		1258,87538	400,52165	1321,0688	397,705132	229,615362	1919,82775	50,0194586	-95,2921614
Item	Date/Time	kW tot	kVAR tot	kVA tot	Vll avg	Vln avg	I avg	Freq	PF sign tot
1	24-06-2021 10:30:00000	1259,6885	401,55069	1322,1414	396,663361	229,013885	1926,1016	50,056412	-95,276375
2	24-06-2021 10:30:05000	1255,8861	386,968689	1314,1517	396,734009	229,054657	1914,1431	50,084263	-95,566299
3	24-06-2021 10:30:10000	1261,7164	405,206726	1325,187	396,859283	229,126999	1929,9109	50,07827	-95,210434
4	24-06-2021 10:30:15000	1263,9889	392,671844	1323,5781	397,147339	229,293304	1926,2479	50,067715	-95,497864
5	24-06-2021 10:30:20000	1258,603	403,169769	1321,6002	397,512421	229,504105	1921,6122	50,068748	-95,233253
6	24-06-2021 10:30:25000	1262,672	401,664642	1325,0189	397,154633	229,297516	1928,4108	50,051754	-95,29464
7	24-06-2021 10:30:30000	1249,1732	395,187775	1310,1935	398,219971	229,912598	1901,7843	50,080093	-95,342651
8	24-06-2021 10:30:35000	1248,2678	407,0289	1312,9528	397,567932	229,536133	1908,6995	50,126987	-95,073318
9	24-06-2021 10:30:40000	1261,85	408,253357	1326,2489	397,175507	229,309586	1929,9541	50,127048	-95,144279
10	24-06-2021 10:30:45000	1266,4119	400,329834	1328,1803	397,052429	229,238525	1933,314	50,086948	-95,349388
11	24-06-2021 10:30:50000	1262,7983	389,492706	1321,5007	397,569427	229,537003	1921,3251	50,075916	-95,557899
12	24-06-2021 10:30:55000	1262,7567	403,182281	1325,5604	397,508301	229,501724	1927,3903	50,061321	-95,2621
13	24-06-2021 10:31:00000	1260,7526	396,277435	1321,5646	397,517365	229,506958	1921,5116	50,060349	-95,398483
14	24-06-2021 10:31:05000	1262,8855	397,904266	1324,0874	397,323547	229,39505	1926,1948	50,064678	-95,3778
15	24-06-2021 10:31:10000	1261,3014	408,314423	1325,7459	397,261505	229,359238	1928,8982	50,054173	-95,139008
16	24-06-2021 10:31:15000	1259,9959	400,768494	1322,197	397,605804	229,558014	1922,1158	50,056145	-95,295624
17	24-06-2021 10:31:20000	1253,3724	400,5867	1315,8314	397,622986	229,567917	1912,8644	50,089821	-95,253273
18	24-06-2021 10:31:25000	1260,575	410,516418	1325,7349	396,881592	229,139877	1930,792	50,088478	-95,084999
19	24-06-2021 10:31:30000	1257,2153	396,785217	1318,3431	397,290009	229,375687	1918,09	50,068539	-95,363281
20	24-06-2021 10:31:35000	1263,3971	399,819427	1325,152	397,045776	229,23468	1929,0967	50,050243	-95,33979
21	24-06-2021 10:31:40000	1268,3376	397,096222	1329,0469	397,087738	229,258896	1934,6766	50,035004	-95,432114
22	24-06-2021 10:31:45000	1253,4683	397,880646	1315,1013	397,775055	229,655731	1911,2745	50,049812	-95,313431
23	24-06-2021 10:31:50000	1256,5228	392,907104	1316,5203	397,505035	229,499832	1914,6608	50,059681	-95,442726
24	24-06-2021 10:31:55000	1256,6226	408,085205	1321,2244	397,533173	229,516068	1921,1783	50,074306	-95,110458
25	24-06-2021 10:32:00000	1255,9558	390,701263	1315,3221	397,248993	229,352005	1914,0406	50,080521	-95,486549
26	24-06-2021 10:32:05000	1260,4142	397,193817	1321,5168	397,198456	229,322815	1923,1989	50,071686	-95,37632

27	24-06-2021 10:32:10000	1265,4349	395,036865	1325,662	397,247986	229,351425	1929,1237	50,057854	-95,456833
28	24-06-2021 10:32:15000	1263,3995	405,819183	1326,9768	397,299561	229,38121	1930,6227	50,048897	-95,208862
29	24-06-2021 10:32:20000	1255,925	398,748352	1317,7056	397,293945	229,37796	1917,2086	50,06736	-95,311508
30	24-06-2021 10:32:25000	1262,1613	391,178406	1321,39	397,273743	229,366318	1922,5863	50,076031	-95,517693
31	24-06-2021 10:32:30000	1262,8987	403,21405	1325,7053	397,197449	229,32225	1929,3077	50,076534	-95,262398
32	24-06-2021 10:32:35000	1262,7778	402,265106	1325,3019	397,020081	229,219849	1929,7316	50,066425	-95,28228
33	24-06-2021 10:32:40000	1260,6289	395,708954	1321,2761	397,161438	229,301453	1923,1565	50,061897	-95,409943
34	24-06-2021 10:32:45000	1258,9982	397,8302	1320,358	397,069885	229,248596	1922,1193	50,057629	-95,352791
35	24-06-2021 10:32:50000	1259,6315	399,875336	1321,5792	396,893158	229,146561	1924,6931	50,059093	-95,312592
36	24-06-2021 10:32:55000	1264,0232	403,903778	1326,9865	396,853271	229,123535	1932,7225	50,039402	-95,255173
37	24-06-2021 10:33:00000	1258,9681	390,612946	1318,1727	396,983124	229,198502	1919,4376	50,034283	-95,508591
38	24-06-2021 10:33:05000	1258,1147	400,756683	1320,4009	397,205719	229,327026	1921,6006	50,045696	-95,282784
39	24-06-2021 10:33:10000	1256,8259	399,235046	1318,7115	397,034149	229,227966	1919,8165	50,054379	-95,307121
40	24-06-2021 10:33:15000	1256,3833	395,443298	1317,1462	397,086456	229,258163	1917,3379	50,063274	-95,386772
41	24-06-2021 10:33:20000	1255,4297	403,384369	1318,6443	397,030548	229,225876	1919,6559	50,080193	-95,206093
42	24-06-2021 10:33:25000	1258,7379	407,233093	1322,9739	396,939484	229,173309	1926,525	50,0839	-95,144577
43	24-06-2021 10:33:30000	1263,0785	388,524445	1321,4835	396,98642	229,200424	1924,0973	50,079704	-95,580353
44	24-06-2021 10:33:35000	1262,2037	412,763123	1327,9803	397,211395	229,330292	1932,5173	50,058468	-95,046875
45	24-06-2021 10:33:40000	1256,2092	390,612793	1315,538	397,292603	229,377197	1913,9517	50,056889	-95,490158
46	24-06-2021 10:33:45000	1254,064	394,408813	1314,6234	397,329803	229,398651	1912,629	50,068966	-95,393402
47	24-06-2021 10:33:50000	1254,4694	404,712769	1318,1373	397,147186	229,293213	1918,4884	50,07856	-95,169861
48	24-06-2021 10:33:55000	1262,0038	397,740356	1323,1973	397,117065	229,275833	1925,9722	50,062859	-95,375336
49	24-06-2021 10:34:00000	1261,1897	400,714661	1323,3185	397,16687	229,304596	1926,0564	50,052303	-95,305077
50	24-06-2021 10:34:05000	1262,8962	393,095459	1322,6606	397,038605	229,230545	1925,5612	50,046547	-95,481506
51	24-06-2021 10:34:10000	1260,922	398,991669	1322,5425	396,987396	229,200958	1925,8265	50,049297	-95,340752
52	24-06-2021 10:34:15000	1267,2605	401,709869	1329,406	396,780365	229,081436	1936,7386	50,017406	-95,325325
53	24-06-2021 10:34:20000	1256,2749	396,078461	1317,2338	397,45636	229,471725	1915,7384	50,023808	-95,372208
54	24-06-2021 10:34:25000	1253,7271	401,500153	1316,4474	397,233734	229,343185	1915,65	50,051865	-95,235634
55	24-06-2021 10:34:30000	1255,7057	395,60907	1316,5498	396,966675	229,188995	1917,1132	50,065334	-95,378517
56	24-06-2021 10:34:35000	1259,0198	407,15918	1323,2192	396,954956	229,182236	1926,7632	50,065361	-95,148232

57	24-06-2021 10:34:40000	1262,3967	393,625122	1322,3413	396,94516	229,176575	1925,5767	50,060497	-95,466789
58	24-06-2021 10:34:45000	1258,5284	408,842804	1323,2711	396,997406	229,206726	1926,7272	50,057026	-95,107384
59	24-06-2021 10:34:50000	1261,5709	394,406555	1321,7858	396,789215	229,086548	1925,6678	50,062603	-95,444427
60	24-06-2021 10:34:55000	1266,9481	405,925476	1330,3884	396,445221	228,887955	1939,8395	50,024406	-95,231453
61	24-06-2021 10:35:00000	1264,3501	382,891693	1321,0553	396,940369	229,173828	1923,7142	50,006165	-95,707581
62	24-06-2021 10:35:05000	1259,6693	405,579041	1323,3522	396,972931	229,192612	1926,879	50,008007	-95,187759
63	24-06-2021 10:35:10000	1261,5664	409,931244	1326,4966	396,662079	229,013153	1932,968	49,995899	-95,105133
64	24-06-2021 10:35:15000	1263,0641	394,903534	1323,3593	396,675476	229,020889	1928,3561	49,986645	-95,443779
65	24-06-2021 10:35:20000	1254,2168	394,63681	1314,8376	397,093933	229,262482	1914,0116	50,013573	-95,389481
66	24-06-2021 10:35:25000	1252,7917	399,887482	1315,0656	397,034149	229,227966	1914,6094	50,046993	-95,264595
67	24-06-2021 10:35:30000	1260,9913	404,752899	1324,358	396,878174	229,137909	1928,7651	50,050007	-95,215294
68	24-06-2021 10:35:35000	1260,1888	400,253479	1322,2249	396,854309	229,124146	1925,8243	50,047195	-95,308205
69	24-06-2021 10:35:40000	1255,4609	389,959686	1314,6295	397,327271	229,397202	1912,6842	50,061485	-95,499222
70	24-06-2021 10:35:45000	1262,3702	405,03363	1325,7567	396,750641	229,064285	1931,3998	50,062752	-95,218849
71	24-06-2021 10:35:50000	1260,1451	397,435669	1321,333	396,941833	229,174667	1923,9738	50,052845	-95,369232
72	24-06-2021 10:35:55000	1257,1514	388,88913	1315,9271	397,407928	229,443787	1913,9136	50,056709	-95,533508
73	24-06-2021 10:36:00000	1257,1021	408,594818	1321,8378	397,289825	229,375595	1923,014	50,076984	-95,102592
74	24-06-2021 10:36:05000	1262,9111	404,699005	1326,1696	396,869598	229,132965	1931,3749	50,069366	-95,229988
75	24-06-2021 10:36:10000	1261,0872	404,596527	1324,4014	397,296783	229,379608	1926,8005	50,06398	-95,219406
76	24-06-2021 10:36:15000	1254,6293	393,672974	1314,9421	397,350159	229,410416	1912,8416	50,085705	-95,413261
77	24-06-2021 10:36:20000	1262,5636	400,861908	1324,6724	396,924683	229,164764	1928,9716	50,08427	-95,311378
78	24-06-2021 10:36:25000	1268,2661	410,043365	1332,9045	396,854034	229,123978	1941,3423	50,052532	-95,150558
79	24-06-2021 10:36:30000	1262,2509	398,459839	1323,6493	396,992493	229,203918	1927,2701	50,036716	-95,361427
80	24-06-2021 10:36:35000	1267,3306	399,119049	1328,6921	396,497162	228,917938	1936,9551	50,014423	-95,381805
81	24-06-2021 10:36:40000	1259,6522	403,609772	1322,7336	396,725464	229,049759	1927,1649	50,013294	-95,230972
82	24-06-2021 10:36:45000	1252,3843	388,964722	1311,3961	396,786407	229,08493	1910,4791	50,039761	-95,500069
83	24-06-2021 10:36:50000	1262,7982	402,184143	1325,2968	396,382294	228,851624	1932,6372	50,037277	-95,284187
84	24-06-2021 10:36:55000	1270,2897	404,433441	1333,1174	396,243347	228,771393	1944,6132	50,007378	-95,287148
85	24-06-2021 10:37:00000	1267,9442	405,791412	1331,2961	396,2883	228,797363	1941,8132	49,979282	-95,241341
86	24-06-2021 10:37:05000	1259,0452	397,946564	1320,4379	397,153137	229,296661	1921,897	49,976536	-95,350578



87	24-06-2021 10:37:10000	1246,0496	408,155762	1311,1945	397,44519	229,465271	1906,9988	50,030857	-95,031647
88	24-06-2021 10:37:15000	1248,8638	393,537109	1309,4015	397,058014	229,241745	1906,1588	50,077122	-95,376694
89	24-06-2021 10:37:20000	1253,2709	397,684875	1314,8541	397,122955	229,279221	1913,8354	50,107182	-95,316353
90	24-06-2021 10:37:25000	1260,1425	410,276917	1325,2495	396,600922	228,977844	1931,4731	50,113373	-95,087189
91	24-06-2021 10:37:30000	1270,4045	391,282379	1329,2965	396,475922	228,90567	1937,9276	50,075348	-95,569679
92	24-06-2021 10:37:35000	1254,1521	398,561615	1315,9592	397,367126	229,420212	1914,2323	50,076336	-95,303261
93	24-06-2021 10:37:40000	1256,4276	399,826569	1318,5112	397,372009	229,423035	1917,8779	50,092449	-95,291389
94	24-06-2021 10:37:45000	1263,0751	395,981415	1323,6918	396,976349	229,194595	1927,3347	50,080635	-95,420631
95	24-06-2021 10:37:50000	1261,4285	393,513855	1321,3837	397,078705	229,253693	1923,4548	50,07951	-95,462692
96	24-06-2021 10:37:55000	1264,653	408,505188	1328,9935	396,805969	229,096222	1935,8375	50,058807	-95,158707
97	24-06-2021 10:38:00000	1262,397	395,88559	1323,016	396,876282	229,136826	1926,8673	50,050407	-95,418114
98	24-06-2021 10:38:05000	1261,8013	398,83728	1323,3342	397,143066	229,290848	1926,1521	50,048161	-95,350151
99	24-06-2021 10:38:10000	1249,7079	410,744995	1315,4775	397,494537	229,493759	1912,9525	50,064537	-95,00032
100	24-06-2021 10:38:15000	1254,4849	395,400116	1315,3225	397,317749	229,391693	1913,4469	50,081478	-95,374695
101	24-06-2021 10:38:20000	1263,1559	398,586182	1324,5505	396,807922	229,097351	1929,3342	50,074619	-95,364883
102	24-06-2021 10:38:25000	1260,2028	401,276184	1322,5481	397,027802	229,224304	1925,3451	50,070675	-95,285965
103	24-06-2021 10:38:30000	1250,5428	397,672913	1312,2504	398,050446	229,814728	1905,5355	50,091679	-95,297577
104	24-06-2021 10:38:35000	1246,2258	396,236847	1307,7012	398,117004	229,853149	1898,6681	50,151367	-95,298973
105	24-06-2021 10:38:40000	1269,3052	402,257294	1331,5204	397,233337	229,342957	1937,5778	50,147243	-95,327507
106	24-06-2021 10:38:45000	1271,6232	396,351471	1331,9611	397,318481	229,392136	1937,7169	50,118614	-95,470001
107	24-06-2021 10:38:50000	1259,1088	392,369537	1318,8286	397,362579	229,417587	1918,5106	50,124844	-95,471756
108	24-06-2021 10:38:55000	1264,7087	403,686401	1327,5734	397,405884	229,442581	1930,8685	50,126099	-95,264702
109	24-06-2021 10:39:00000	1264,458	398,178864	1325,6698	397,331757	229,399796	1928,5459	50,11203	-95,382576
110	24-06-2021 10:39:05000	1261,7957	398,544952	1323,2408	397,501404	229,497742	1924,16	50,106377	-95,356461
111	24-06-2021 10:39:10000	1260,7579	396,976593	1321,7795	397,618469	229,565323	1921,5321	50,105106	-95,383377
112	24-06-2021 10:39:15000	1258,7517	398,244751	1320,2479	397,680084	229,600906	1919,007	50,105461	-95,342064
113	24-06-2021 10:39:20000	1247,0178	400,614563	1309,7883	397,447876	229,466827	1904,8624	50,131111	-95,207581
114	24-06-2021 10:39:25000	1270,2513	393,974823	1329,9453	396,330444	228,821671	1939,542	50,106827	-95,511543
115	24-06-2021 10:39:30000	1278,0696	408,989166	1341,9142	396,249481	228,774948	1957,4546	50,013355	-95,242264
116	24-06-2021 10:39:35000	1259,2045	395,184937	1319,7603	397,220673	229,335648	1920,6688	50,000298	-95,411606

117	24-06-2021 10:39:40000	1251,4517	402,235138	1314,5052	397,415436	229,448105	1912,0914	50,039902	-95,203239
118	24-06-2021 10:39:45000	1254,4464	409,229187	1319,5092	396,84668	229,11972	1921,8379	50,047405	-95,069176
119	24-06-2021 10:39:50000	1255,5658	385,777252	1313,4951	396,841309	229,116638	1913,0761	50,050232	-95,589676
120	24-06-2021 10:39:55000	1257,8649	402,354584	1320,6489	397,04538	229,234436	1922,9335	50,06852	-95,245979
121	24-06-2021 10:40:00000	1258,8499	402,342926	1321,5834	397,334564	229,401398	1922,7209	50,078716	-95,253151
122	24-06-2021 10:40:05000	1254,5184	399,478943	1316,5864	397,170654	229,306778	1916,2638	50,086731	-95,285683
123	24-06-2021 10:40:10000	1263,3146	404,301453	1326,4326	397,219574	229,335022	1930,4873	50,078251	-95,241524
124	24-06-2021 10:40:15000	1262,1274	399,378662	1323,8086	397,109436	229,271423	1927,0243	50,058792	-95,340637
125	24-06-2021 10:40:20000	1256,7286	391,570007	1316,3184	397,390106	229,433472	1914,7944	50,055637	-95,473
126	24-06-2021 10:40:25000	1254,6324	400,307373	1316,9467	397,328857	229,398117	1916,1433	50,066051	-95,26828
127	24-06-2021 10:40:30000	1254,3322	404,77417	1318,0255	397,582062	229,544296	1916,2721	50,092419	-95,167519
128	24-06-2021 10:40:35000	1267,3212	410,430328	1332,1246	396,717285	229,045013	1941,0587	50,070381	-95,13533
129	24-06-2021 10:40:40000	1257,3665	395,932007	1318,2308	397,059692	229,242706	1919,0292	50,06216	-95,382874
130	24-06-2021 10:40:45000	1257,5115	407,737427	1321,9624	396,760529	229,069977	1925,9243	50,059662	-95,124596
131	24-06-2021 10:40:50000	1262,1558	391,633179	1321,5195	396,878784	229,13826	1924,7168	50,05294	-95,507919
132	24-06-2021 10:40:55000	1258,6757	394,632874	1319,0905	396,953522	229,181412	1920,8369	50,055645	-95,419968
133	24-06-2021 10:41:00000	1257,468	406,671234	1321,5927	396,960236	229,185287	1924,3474	50,05798	-95,147926
134	24-06-2021 10:41:05000	1253,806	397,594818	1315,3369	397,066956	229,246887	1915,0033	50,0765	-95,322044
135	24-06-2021 10:41:10000	1250,0659	398,074982	1311,918	397,214081	229,331848	1909,2684	50,116264	-95,285378
136	24-06-2021 10:41:15000	1260,7144	397,148315	1321,7894	396,732452	229,053787	1925,7815	50,103378	-95,379356
137	24-06-2021 10:41:20000	1269,3125	399,947418	1330,8313	396,819397	229,103973	1938,5713	50,070625	-95,377411
138	24-06-2021 10:41:25000	1262,9786	400,062866	1324,8265	397,021729	229,220795	1928,723	50,040237	-95,331627
139	24-06-2021 10:41:30000	1252,8799	392,500366	1312,9221	397,629913	229,57193	1908,4084	50,058018	-95,426826
140	24-06-2021 10:41:35000	1253,387	401,339539	1316,0746	397,690552	229,606949	1912,8728	50,09148	-95,236771
141	24-06-2021 10:41:40000	1271,5723	392,311737	1330,7157	396,655304	229,009247	1939,3993	50,057793	-95,555511
142	24-06-2021 10:41:45000	1266,0903	399,944489	1327,7576	397,218506	229,334412	1932,1989	50,038475	-95,35553
143	24-06-2021 10:41:50000	1247,5084	409,01416	1312,8479	397,454834	229,47084	1909,2677	50,064716	-95,023064
144	24-06-2021 10:41:55000	1261,4878	395,979462	1322,1766	396,803436	229,094772	1925,8672	50,065868	-95,409927
145	24-06-2021 10:42:00000	1259,1691	404,209564	1322,4568	397,17865	229,311386	1924,443	50,054825	-95,214378
146	24-06-2021 10:42:05000	1261,9059	403,369965	1324,807	396,989044	229,20192	1929,0482	50,056583	-95,252052

147	24-06-2021 10:42:10000	1268,6925	389,815094	1327,2289	396,742523	229,059601	1933,8275	50,050163	-95,589577
148	24-06-2021 10:42:15000	1270,1307	412,117126	1335,3174	396,575287	228,963043	1946,6104	50,019535	-95,118263
149	24-06-2021 10:42:20000	1254,3911	400,406189	1316,7469	396,852844	229,123291	1917,774	50,027588	-95,264412
150	24-06-2021 10:42:25000	1247,1798	395,797028	1308,4772	397,180634	229,312515	1904,2108	50,074234	-95,315361
151	24-06-2021 10:42:30000	1256,4269	406,322113	1320,4948	396,891052	229,14534	1923,1312	50,097504	-95,148201
152	24-06-2021 10:42:35000	1249,2932	417,357727	1317,1639	397,070953	229,249207	1917,35	50,093365	-94,847198
153	24-06-2021 10:42:40000	1262,6869	381,010498	1318,9189	397,007629	229,212662	1920,1898	50,079929	-95,736504
154	24-06-2021 10:42:45000	1252,9139	410,423584	1318,4236	397,256836	229,356522	1918,2374	50,114208	-95,031212
155	24-06-2021 10:42:50000	1259,4347	408,176208	1323,9274	397,09436	229,262741	1927,0264	50,114384	-95,128685
156	24-06-2021 10:42:55000	1261,5096	405,479858	1325,0739	397,017487	229,218338	1929,0676	50,097652	-95,202972
157	24-06-2021 10:43:00000	1253,6997	389,694	1312,8687	397,154968	229,297729	1911,0018	50,102947	-95,493149
158	24-06-2021 10:43:05000	1262,0471	401,098694	1324,252	397,137756	229,287766	1927,4945	50,088593	-95,30265
159	24-06-2021 10:43:10000	1264,1276	404,030304	1327,1243	396,931519	229,168716	1932,7157	50,056221	-95,253136
160	24-06-2021 10:43:15000	1265,2582	401,957581	1327,5723	397,243591	229,348877	1931,8466	50,05648	-95,30616
161	24-06-2021 10:43:20000	1257,0956	413,785461	1323,4453	397,243439	229,348801	1925,8158	50,055706	-94,986588
162	24-06-2021 10:43:25000	1257,4915	400,41748	1319,7042	397,151184	229,295532	1920,683	50,055084	-95,285866
163	24-06-2021 10:43:30000	1255,7244	398,860046	1317,5481	396,843201	229,117722	1919,0317	50,074333	-95,307671
164	24-06-2021 10:43:35000	1251,223	403,487274	1314,6715	397,103973	229,268265	1913,6759	50,100086	-95,17382
165	24-06-2021 10:43:40000	1270,1643	395,805084	1330,4056	396,258942	228,780411	1940,6639	50,065029	-95,471962
166	24-06-2021 10:43:45000	1260,1782	395,953796	1320,9196	396,797333	229,091248	1924,1709	50,046722	-95,401581
167	24-06-2021 10:43:50000	1254,9447	402,337921	1317,8627	396,94223	229,174881	1919,1257	50,065411	-95,225754
168	24-06-2021 10:43:55000	1257,6533	405,151886	1321,3024	397,068054	229,247528	1923,4803	50,074379	-95,182854
169	24-06-2021 10:44:00000	1254,0393	397,627899	1315,5693	397,083344	229,256348	1915,0596	50,095814	-95,322937
170	24-06-2021 10:44:05000	1255,2603	405,498352	1319,1312	397,062897	229,244553	1920,4197	50,106113	-95,158104
171	24-06-2021 10:44:10000	1257,976	397,070343	1319,1544	397,112244	229,273041	1920,1731	50,119038	-95,362297
172	24-06-2021 10:44:15000	1260,667	401,237885	1322,9789	396,892395	229,146118	1926,6985	50,115891	-95,290031
173	24-06-2021 10:44:20000	1265,3022	403,513062	1328,0861	397,083923	229,256699	1933,2719	50,090809	-95,272614
174	24-06-2021 10:44:25000	1268,1487	400,919098	1330,0139	397,03125	229,226288	1936,6329	50,070847	-95,348518
175	24-06-2021 10:44:30000	1262,8645	395,595062	1323,3752	396,83783	229,114609	1927,6659	50,055935	-95,427544
176	24-06-2021 10:44:35000	1258,7175	402,571503	1321,527	397,611755	229,561447	1921,5397	50,063282	-95,2472

177	24-06-2021 10:44:40000	1234,7189	390,480042	1294,9924	398,169708	229,883575	1879,9368	50,151497	-95,345642
178	24-06-2021 10:44:45000	1253,2236	408,001129	1317,9659	397,161255	229,301361	1918,0941	50,188011	-95,087708
179	24-06-2021 10:44:50000	1270,7836	396,812408	1331,2968	396,852325	229,122986	1939,0264	50,146637	-95,454567
180	24-06-2021 10:44:55000	1264,7969	398,628357	1326,1281	397,328705	229,398026	1929,1272	50,118416	-95,375168
181	24-06-2021 10:45:00000	1268,9828	402,761261	1331,3655	397,282684	229,371445	1936,9913	50,081215	-95,314384
182	24-06-2021 10:45:05000	1250,9675	401,600159	1313,8502	397,866302	229,708405	1908,8347	50,080547	-95,21386
183	24-06-2021 10:45:10000	1250,8265	407,130463	1315,4171	397,712402	229,619553	1912,0295	50,113132	-95,089722
184	24-06-2021 10:45:15000	1253,5299	394,805267	1314,233	397,344482	229,407135	1911,8746	50,128365	-95,381104
185	24-06-2021 10:45:20000	1255,0253	401,760529	1317,7633	397,847961	229,697815	1914,4541	50,151993	-95,239059
186	24-06-2021 10:45:25000	1266,4149	408,413971	1330,6423	397,243988	229,349106	1936,1046	50,139084	-95,17321
187	24-06-2021 10:45:30000	1266,9044	405,91806	1330,3444	397,612488	229,561874	1933,9729	50,119102	-95,231308
188	24-06-2021 10:45:35000	1262,0813	397,950134	1323,3342	397,24292	229,34848	1925,5322	50,113628	-95,371315
189	24-06-2021 10:45:40000	1269,0551	392,991913	1328,5117	396,955841	229,182755	1934,3439	50,075283	-95,524567
190	24-06-2021 10:45:45000	1263,3193	405,657532	1326,8511	397,157532	229,29921	1930,955	50,064857	-95,211838
191	24-06-2021 10:45:50000	1251,76	390,976837	1311,3986	397,766907	229,651031	1905,6023	50,094746	-95,452301
192	24-06-2021 10:45:55000	1258,3368	404,393616	1321,7207	397,516571	229,5065	1921,6923	50,118176	-95,204437
193	24-06-2021 10:46:00000	1258,4056	391,625824	1317,9362	397,258972	229,357773	1917,4684	50,126083	-95,483055
194	24-06-2021 10:46:05000	1262,8899	392,031647	1322,3387	397,073212	229,250519	1924,8218	50,114761	-95,504265
195	24-06-2021 10:46:10000	1258,0208	404,247131	1321,3751	397,172791	229,308014	1922,8458	50,125916	-95,205429
196	24-06-2021 10:46:15000	1265,5656	391,042877	1324,6021	396,973389	229,192886	1928,5931	50,107372	-95,543076
197	24-06-2021 10:46:20000	1266,9606	398,564117	1328,1726	396,84671	229,119766	1934,26	50,082577	-95,391258
198	24-06-2021 10:46:25000	1262,4817	404,577881	1325,7236	397,032288	229,226898	1929,9127	50,068264	-95,229622
199	24-06-2021 10:46:30000	1252,9189	408,24762	1317,7528	397,215271	229,332535	1917,3619	50,074234	-95,079979
200	24-06-2021 10:46:35000	1247,7413	393,855835	1308,4268	397,470062	229,479645	1902,7572	50,106049	-95,361946
201	24-06-2021 10:46:40000	1257,9852	397,395233	1319,2611	397,270325	229,364334	1919,5782	50,110691	-95,355293
202	24-06-2021 10:46:45000	1259,0198	405,528381	1322,7184	397,131592	229,284225	1925,0272	50,104641	-95,184265
203	24-06-2021 10:46:50000	1258,1088	397,150085	1319,3051	397,336304	229,40242	1919,2856	50,105732	-95,361473
204	24-06-2021 10:46:55000	1259,4382	397,210144	1320,5909	397,517059	229,50679	1920,6597	50,117809	-95,369286
205	24-06-2021 10:47:00000	1262,3477	404,749542	1325,6484	397,084991	229,257324	1929,7534	50,106441	-95,224922
206	24-06-2021 10:47:05000	1261,4496	396,505646	1322,298	396,957275	229,183578	1925,387	50,10881	-95,398293

207	24-06-2021 10:47:10000	1258,0776	397,45813	1319,3682	397,194763	229,320694	1919,8877	50,114941	-95,354553
208	24-06-2021 10:47:15000	1268,2679	409,926636	1332,8704	396,148132	228,716431	1944,0979	50,099609	-95,153137
209	24-06-2021 10:47:20000	1260,239	414,428101	1326,6322	395,959198	228,60733	1935,8756	50,090485	-94,995354
210	24-06-2021 10:47:25000	1263,0721	398,077606	1324,3176	395,487	228,334717	1934,7607	50,072346	-95,37532
211	24-06-2021 10:47:30000	1262,4146	413,05484	1328,2712	395,971527	228,614441	1938,2144	50,067604	-95,041916
212	24-06-2021 10:47:35000	1250,849	415,759064	1318,1346	396,243195	228,771301	1922,1147	50,094036	-94,895393
213	24-06-2021 10:47:40000	1264,7336	404,161835	1327,7417	395,710571	228,463791	1938,623	50,105267	-95,254494
214	24-06-2021 10:47:45000	1267,3677	408,009338	1331,4249	395,580231	228,38855	1944,7424	50,074024	-95,18882
215	24-06-2021 10:47:50000	1260,1694	403,822998	1323,2913	395,935211	228,593491	1931,0895	50,056816	-95,229927
216	24-06-2021 10:47:55000	1254,514	407,276764	1318,9692	396,10083	228,689117	1923,8773	50,066051	-95,113213
217	24-06-2021 10:48:00000	1251,5863	403,399445	1314,9904	396,26535	228,784103	1917,2954	50,096336	-95,178368
218	24-06-2021 10:48:05000	1256,5962	407,817657	1321,1166	395,290131	228,221039	1931,0392	50,104294	-95,116219
219	24-06-2021 10:48:10000	1260,5511	407,797699	1324,8729	395,821472	228,527817	1934,1108	50,091946	-95,145065
220	24-06-2021 10:48:15000	1256,5879	408,735291	1321,3923	395,93869	228,59549	1928,3524	50,106529	-95,095749
221	24-06-2021 10:48:20000	1262,4188	409,494415	1327,1725	395,70752	228,462036	1937,807	50,097172	-95,120926
222	24-06-2021 10:48:25000	1265,7559	412,283112	1331,2083	395,781647	228,504822	1943,4045	50,073441	-95,083237
223	24-06-2021 10:48:30000	1258,1796	404,183197	1321,5067	395,868042	228,554718	1928,7346	50,077385	-95,207962
224	24-06-2021 10:48:35000	1260,1609	413,305786	1326,2078	395,685394	228,449249	1936,5084	50,062649	-95,019867
225	24-06-2021 10:48:40000	1256,348	412,154785	1322,2262	395,357727	228,260101	1932,2141	50,066151	-95,017639
226	24-06-2021 10:48:45000	1247,0472	404,371979	1310,9705	395,665161	228,437576	1914,4735	50,079849	-95,123978
227	24-06-2021 10:48:50000	1254,7351	410,312439	1320,1198	396,015228	228,639679	1926,0136	50,091648	-95,047058
228	24-06-2021 10:48:55000	1259,3353	402,108368	1321,9745	395,357513	228,259949	1931,9697	50,08699	-95,261696
229	24-06-2021 10:49:00000	1265,115	415,593414	1331,6283	395,462433	228,320541	1945,5109	50,06543	-95,005119
230	24-06-2021 10:49:05000	1257,7625	413,213013	1323,9	395,997284	228,629318	1931,702	50,058548	-95,004333
231	24-06-2021 10:49:10000	1262,7598	406,560791	1326,5948	395,728485	228,474136	1936,8534	50,054272	-95,188049
232	24-06-2021 10:49:15000	1257,3168	411,259827	1322,8682	395,722473	228,470657	1931,5277	50,050762	-95,044754
233	24-06-2021 10:49:20000	1259,2927	399,33606	1321,0933	395,493835	228,338654	1930,0922	50,042934	-95,322014
234	24-06-2021 10:49:25000	1259,1855	413,968628	1325,4879	395,492493	228,337891	1936,4437	50,02969	-94,997887
235	24-06-2021 10:49:30000	1246,6776	399,879517	1309,2399	396,013977	228,638962	1910,1827	50,066456	-95,221489
236	24-06-2021 10:49:35000	1259,283	407,22998	1323,4915	395,220215	228,180679	1934,8243	50,071236	-95,148544

237	24-06-2021 10:49:40000	1264,7838	413,022034	1330,5132	394,937744	228,017593	1946,4282	50,062569	-95,059853
238	24-06-2021 10:49:45000	1261,2079	405,620361	1324,8293	395,460907	228,319641	1935,6868	50,054539	-95,197746
239	24-06-2021 10:49:50000	1253,4579	406,827972	1317,8262	395,352112	228,256851	1925,8909	50,069786	-95,115578
240	24-06-2021 10:49:55000	1258,9193	408,594299	1323,566	395,348236	228,254608	1934,3335	50,065891	-95,115715
241	24-06-2021 10:50:00000	1256,0356	409,871887	1321,2194	395,166473	228,149658	1931,8258	50,06562	-95,066399
242	24-06-2021 10:50:05000	1262,5137	403,386536	1325,3911	394,8573	227,971161	1939,4724	50,048054	-95,255936
243	24-06-2021 10:50:10000	1261,9471	419,236328	1329,7631	395,176971	228,155716	1944,3287	50,03688	-94,900154
244	24-06-2021 10:50:15000	1264,2916	404,996033	1327,575	395,035706	228,074158	1941,9072	50,015911	-95,23317
245	24-06-2021 10:50:20000	1259,2144	412,705933	1325,1215	394,990601	228,048126	1938,4633	50,011379	-95,026329
246	24-06-2021 10:50:25000	1255,0521	400,607422	1317,4376	395,457672	228,31778	1924,926	50,045601	-95,264626
247	24-06-2021 10:50:30000	1257,0072	407,100677	1321,2865	395,308014	228,231369	1931,2448	50,054623	-95,135094
248	24-06-2021 10:50:35000	1258,9945	414,572876	1325,4952	395,119293	228,122421	1938,2083	50,049553	-94,982948
249	24-06-2021 10:50:40000	1267,0979	398,997223	1328,4336	395,05896	228,087585	1942,7839	50,032204	-95,382851
250	24-06-2021 10:50:45000	1256,728	406,31543	1320,7791	395,151886	228,141251	1931,2092	50,023502	-95,150505
251	24-06-2021 10:50:50000	1260,0618	411,287292	1325,4858	395,152405	228,141541	1937,9824	50,004032	-95,06414
252	24-06-2021 10:50:55000	1254,7974	411,871124	1320,6644	395,439606	228,307358	1929,5291	50,014091	-95,012589
253	24-06-2021 10:51:00000	1252,2367	406,546051	1316,5775	395,58844	228,39328	1922,9302	50,038059	-95,113022
254	24-06-2021 10:51:05000	1246,1918	411,873077	1312,4913	395,744781	228,483536	1916,2056	50,077789	-94,948578
255	24-06-2021 10:51:10000	1256,9396	405,32077	1320,6749	395,1203	228,123001	1931,2274	50,084213	-95,174042
256	24-06-2021 10:51:15000	1263,4355	408,062958	1327,699	395,020905	228,065598	1941,9702	50,068287	-95,159782
257	24-06-2021 10:51:20000	1266,0958	404,782928	1329,2283	395,341675	228,250809	1942,6351	50,02935	-95,250443
258	24-06-2021 10:51:25000	1259,1545	402,329681	1321,8698	395,705048	228,460602	1930,0808	50,019089	-95,255577
259	24-06-2021 10:51:30000	1253,0837	408,914398	1318,1161	395,815918	228,524612	1924,0614	50,044456	-95,066269
260	24-06-2021 10:51:35000	1257,5713	403,478943	1320,7122	395,464935	228,321976	1929,6527	50,059422	-95,219177
261	24-06-2021 10:51:40000	1264,0884	411,703003	1329,443	395,229462	228,18602	1943,4681	50,040192	-95,084061
262	24-06-2021 10:51:45000	1263,647	408,144348	1327,9252	395,382965	228,274658	1940,6885	50,035061	-95,159492
263	24-06-2021 10:51:50000	1257,7011	416,841522	1324,9788	395,363312	228,263306	1936,4	50,030529	-94,922356
264	24-06-2021 10:51:55000	1262,1125	408,339417	1326,5253	395,21228	228,176102	1939,3154	50,026676	-95,144257
265	24-06-2021 10:52:00000	1260,1985	413,435333	1326,2839	395,415588	228,293472	1938,0387	50,026356	-95,01725
266	24-06-2021 10:52:05000	1260,7714	405,158661	1324,2726	395,153046	228,141907	1936,3188	50,01963	-95,204819

267	24-06-2021 10:52:10000	1263,6915	399,247437	1325,2603	394,882874	227,985931	1939,1418	50,010841	-95,354218
268	24-06-2021 10:52:15000	1257,8281	413,908691	1324,1798	394,961029	228,031036	1937,02	50,009048	-94,989227
269	24-06-2021 10:52:20000	1250,2351	396,294739	1311,5402	395,265015	228,206558	1917,2523	50,02692	-95,325729
270	24-06-2021 10:52:25000	1249,6921	409,705322	1315,1383	395,335541	228,247269	1922,0865	50,047684	-95,023628
271	24-06-2021 10:52:30000	1256,8873	404,439423	1320,3549	395,535614	228,362778	1928,8654	50,063618	-95,193146
272	24-06-2021 10:52:35000	1253,3693	418,47049	1321,3827	395,563995	228,379166	1930,0945	50,079208	-94,852867
273	24-06-2021 10:52:40000	1265,1824	411,01413	1330,2703	394,847443	227,965469	1946,512	50,057293	-95,107162
274	24-06-2021 10:52:45000	1259,2369	403,3862	1322,2701	395,314697	228,235245	1932,5433	50,02935	-95,232964
275	24-06-2021 10:52:50000	1255,9109	401,548279	1318,5421	395,620636	228,41188	1925,7028	50,047836	-95,249969
276	24-06-2021 10:52:55000	1251,9863	416,003326	1319,2909	395,462067	228,320313	1927,5959	50,077541	-94,89843
277	24-06-2021 10:53:00000	1261,0789	401,789581	1323,5387	394,725037	227,894791	1937,3319	50,06953	-95,280846
278	24-06-2021 10:53:05000	1269,3555	405,671936	1332,6039	394,561951	227,800644	1951,3213	50,024506	-95,253777
279	24-06-2021 10:53:10000	1262,4946	405,232086	1325,9358	395,01709	228,063431	1939,4708	49,998795	-95,215363
280	24-06-2021 10:53:15000	1256,9312	398,362976	1318,548	395,265106	228,206604	1927,3115	50,006874	-95,326912
281	24-06-2021 10:53:20000	1257,0955	409,778625	1322,198	395,036682	228,074722	1933,8093	50,012554	-95,076187
282	24-06-2021 10:53:25000	1257,6747	407,445343	1322,0277	395,19809	228,167923	1932,693	50,019913	-95,132248
283	24-06-2021 10:53:30000	1257,0433	405,542786	1320,8417	395,274933	228,212296	1930,7449	50,033092	-95,169868
284	24-06-2021 10:53:35000	1250,5018	405,439453	1314,5858	395,48999	228,336441	1920,452	50,061764	-95,125153
285	24-06-2021 10:53:40000	1258,8954	402,049835	1321,5376	395,139252	228,133942	1932,5493	50,063393	-95,259895
286	24-06-2021 10:53:45000	1258,7832	413,38797	1324,9244	395,307098	228,23085	1936,4819	50,059517	-95,007927
287	24-06-2021 10:53:50000	1260,9272	409,364197	1325,7136	395,33075	228,244507	1937,5785	50,058823	-95,113098
288	24-06-2021 10:53:55000	1261,0951	408,133759	1325,4939	394,880219	227,98439	1939,3562	50,037277	-95,141525
289	24-06-2021 10:54:00000	1261,7539	398,059753	1323,0549	395,18631	228,161118	1934,2523	50,025932	-95,366699
290	24-06-2021 10:54:05000	1265,4836	404,976501	1328,7042	395,167694	228,150375	1942,7625	50,015274	-95,241943
291	24-06-2021 10:54:10000	1251,8123	412,555206	1318,0424	395,574707	228,385345	1925,162	50,041321	-94,975113
292	24-06-2021 10:54:15000	1256,0275	402,499878	1318,9431	395,403198	228,286316	1927,2722	50,050289	-95,229836
293	24-06-2021 10:54:20000	1252,1423	412,171356	1318,2357	395,376617	228,270981	1926,3594	50,067238	-94,986214
294	24-06-2021 10:54:25000	1262,9934	400,67926	1325,0269	395,058777	228,087479	1937,8084	50,05957	-95,318329
295	24-06-2021 10:54:30000	1257,3036	410,673248	1322,6735	395,292999	228,222717	1933,233	50,052448	-95,057755
296	24-06-2021 10:54:35000	1260,9813	404,017853	1324,1239	395,15451	228,142761	1936,042	50,057228	-95,231361

297	24-06-2021 10:54:40000	1261,7814	416,898468	1328,8704	395,096466	228,109222	1943,196	50,036308	-94,951424
298	24-06-2021 10:54:45000	1260,6884	410,968842	1325,9829	395,332825	228,245697	1937,8813	50,033081	-95,075768
299	24-06-2021 10:54:50000	1259,4204	405,435547	1323,0713	395,218964	228,179977	1934,161	50,036636	-95,189156
300	24-06-2021 10:54:55000	1260,3007	408,417877	1324,8256	395,016479	228,063065	1937,715	50,015759	-95,129547
301	24-06-2021 10:55:00000	1266,176	411,933655	1331,4995	395,224762	228,183319	1946,5421	50,008976	-95,093987
302	24-06-2021 10:55:05000	1255,933	402,460144	1318,8412	395,292816	228,22261	1927,7506	50,030334	-95,230049
303	24-06-2021 10:55:10000	1259,0837	404,482605	1322,4591	394,950073	228,024734	1934,6796	50,046021	-95,207764
304	24-06-2021 10:55:15000	1259,5059	406,194977	1323,3856	395,018311	228,064117	1935,6466	50,048161	-95,173012
305	24-06-2021 10:55:20000	1264,0338	409,088776	1328,5839	394,787048	227,930618	1944,4149	50,031994	-95,141441
306	24-06-2021 10:55:25000	1253,7428	405,54541	1317,7018	395,417084	228,294357	1925,567	50,061436	-95,146172
307	24-06-2021 10:55:30000	1261,2231	416,112915	1328,0941	395,18689	228,161453	1941,9099	50,051064	-94,964897
308	24-06-2021 10:55:35000	1261,3035	402,99527	1324,1191	395,331665	228,245041	1935,1047	50,045982	-95,256035
309	24-06-2021 10:55:40000	1260,0054	408,546356	1324,5842	395,41272	228,291824	1935,4142	50,057896	-95,124588
310	24-06-2021 10:55:45000	1258,1708	420,540833	1326,5928	394,948669	228,023911	1940,6671	50,047432	-94,842278
311	24-06-2021 10:55:50000	1260,7306	400,63858	1322,8578	395,010071	228,059357	1934,8444	50,034084	-95,303558
312	24-06-2021 10:55:55000	1260,6285	414,484222	1327,0198	394,869751	227,978348	1941,6187	50,020157	-94,996971
313	24-06-2021 10:56:00000	1265,8619	405,507751	1329,2264	394,714813	227,888901	1945,6637	49,990395	-95,232979
314	24-06-2021 10:56:05000	1262,609	410,220947	1327,5778	394,998108	228,052444	1941,9237	49,972115	-95,106216
315	24-06-2021 10:56:10000	1256,329	406,891907	1320,577	395,21405	228,177139	1930,5294	49,974648	-95,134857
316	24-06-2021 10:56:15000	1254,7396	407,398163	1319,2213	395,014404	228,061859	1929,5664	49,99543	-95,112144
317	24-06-2021 10:56:20000	1259,781	404,141022	1323,0184	394,87738	227,982773	1935,8561	49,992043	-95,220207
318	24-06-2021 10:56:25000	1245,7836	405,473969	1310,1091	395,258789	228,202957	1915,1187	50,028278	-95,090065
319	24-06-2021 10:56:30000	1248,3586	413,078674	1314,927	395,44751	228,311905	1921,2368	50,083332	-94,937477
320	24-06-2021 10:56:35000	1260,8594	414,742188	1327,3197	394,930145	228,013229	1941,8513	50,073391	-94,992897
321	24-06-2021 10:56:40000	1268,3149	411,652954	1333,447	394,763245	227,916855	1951,5576	50,029858	-95,115509
322	24-06-2021 10:56:45000	1265,7764	399,164825	1327,2235	395,108826	228,116379	1940,7786	50,00666	-95,370247
323	24-06-2021 10:56:50000	1251,2977	412,06424	1317,4001	395,60611	228,403503	1923,9767	50,031254	-94,982368
324	24-06-2021 10:56:55000	1250,4866	402,411652	1313,6407	395,525879	228,357162	1918,9144	50,060722	-95,192436
325	24-06-2021 10:57:00000	1259,4937	411,421387	1324,9874	395,047699	228,0811	1937,7451	50,068443	-95,057022
326	24-06-2021 10:57:05000	1265,1047	407,338898	1329,0654	394,709351	227,885742	1945,3303	50,047268	-95,187538



327	24-06-2021 10:57:10000	1265,23	413,811218	1331,1824	394,783783	227,928726	1948,0824	50,009399	-95,04557
328	24-06-2021 10:57:15000	1260,5736	403,053406	1323,4417	395,129578	228,128372	1935,0441	50,006069	-95,249657
329	24-06-2021 10:57:20000	1259,2717	407,564209	1323,5837	395,153168	228,141998	1935,1827	50,009678	-95,141068
330	24-06-2021 10:57:25000	1263,5056	409,746765	1328,2841	394,95871	228,029724	1942,9277	50,001369	-95,123138
331	24-06-2021 10:57:30000	1243,812	409,147034	1309,3776	396,060608	228,665909	1910,031	50,048759	-94,992615
332	24-06-2021 10:57:35000	1246,072	414,083221	1313,0729	396,034607	228,650894	1915,4558	50,093376	-94,8974
333	24-06-2021 10:57:40000	1252,6624	410,487274	1318,2043	395,278839	228,214539	1926,6434	50,11166	-95,027931
334	24-06-2021 10:57:45000	1263,7905	402,923096	1326,4666	395,445038	228,310486	1937,9521	50,098179	-95,274963
335	24-06-2021 10:57:50000	1263,1804	410,405212	1328,1782	395,381775	228,273987	1940,8357	50,086567	-95,106247
336	24-06-2021 10:57:55000	1262,5287	410,167267	1327,4847	395,397949	228,28331	1939,6993	50,065407	-95,106827
337	24-06-2021 10:58:00000	1258,7096	407,118896	1322,9119	395,818237	228,52597	1930,9489	50,064484	-95,146904
338	24-06-2021 10:58:05000	1258,4369	408,501587	1323,0785	395,686432	228,44986	1931,9004	50,07357	-95,114296
339	24-06-2021 10:58:10000	1254,655	419,761353	1323,0112	395,709869	228,463394	1931,5869	50,087849	-94,833282
340	24-06-2021 10:58:15000	1259,2687	406,754181	1323,3315	395,571625	228,383575	1932,7474	50,092274	-95,158966
341	24-06-2021 10:58:20000	1256,106	410,08493	1321,3523	395,496033	228,339935	1930,269	50,095093	-95,062157
342	24-06-2021 10:58:25000	1262,6532	411,232208	1327,9326	395,306183	228,230331	1940,7793	50,081852	-95,084129
343	24-06-2021 10:58:30000	1260,6353	401,822937	1323,1262	395,500793	228,342682	1932,9081	50,069584	-95,277023
344	24-06-2021 10:58:35000	1261,9183	408,385651	1326,3546	395,467834	228,323654	1937,7421	50,059456	-95,141846
345	24-06-2021 10:58:40000	1254,8241	415,039276	1321,6813	395,740082	228,48082	1929,6339	50,080441	-94,941513
346	24-06-2021 10:58:45000	1265,4143	398,369843	1326,6394	395,485504	228,333862	1938,0867	50,070175	-95,384956
347	24-06-2021 10:58:50000	1260,5995	418,043457	1328,1083	395,491638	228,337402	1940,0668	50,064495	-94,916924
348	24-06-2021 10:58:55000	1259,9075	410,82135	1325,1948	395,467896	228,3237	1936,074	50,053638	-95,073387
349	24-06-2021 10:59:00000	1253,8984	400,592163	1316,3341	395,674042	228,442703	1922,0514	50,06575	-95,256859
350	24-06-2021 10:59:05000	1246,3051	416,944366	1314,199	396,203796	228,748566	1916,4813	50,113846	-94,833817
351	24-06-2021 10:59:10000	1254,4045	401,580414	1317,1172	395,620911	228,412018	1923,658	50,1399	-95,238647
352	24-06-2021 10:59:15000	1259,187	409,355164	1324,0557	395,36554	228,264603	1934,9376	50,133675	-95,100754
353	24-06-2021 10:59:20000	1275,434	403,611267	1337,772	395,238403	228,191193	1955,5311	50,081516	-95,340164
354	24-06-2021 10:59:25000	1269,1371	405,626892	1332,3821	395,704132	228,460083	1945,386	50,035542	-95,253235
355	24-06-2021 10:59:30000	1247,9537	410,775726	1313,8209	396,225098	228,760864	1915,9913	50,066666	-94,986595
356	24-06-2021 10:59:35000	1257,5488	403,120117	1320,5813	395,798645	228,514648	1927,6893	50,090462	-95,226921

357	24-06-2021 10:59:40000	1253,9094	413,32843	1320,2761	395,742188	228,48204	1927,561	50,111935	-94,973267
358	24-06-2021 10:59:45000	1258,9492	407,545227	1323,2711	395,718567	228,468414	1931,9889	50,106071	-95,139183
359	24-06-2021 10:59:50000	1259,0668	407,118042	1323,2513	395,53952	228,365036	1932,7754	50,097347	-95,149475
360	24-06-2021 10:59:55000	1265,4888	400,76059	1327,4302	395,333893	228,246323	1939,8965	50,072872	-95,333733
361	24-06-2021 11:00:00000	1263,5498	409,235596	1328,1686	395,500153	228,342316	1940,2437	50,04475	-95,134743
362	24-06-2021 11:00:05000	1261,4207	408,810883	1326,0122	395,706909	228,461685	1936,0708	50,035385	-95,128883
363	24-06-2021 11:00:10000	1251,244	405,096436	1315,1863	396,085693	228,680374	1918,4452	50,063221	-95,138168
364	24-06-2021 11:00:15000	1254,7621	413,590485	1321,168	395,711548	228,464355	1928,9203	50,088856	-94,973694
365	24-06-2021 11:00:20000	1266,7921	413,430267	1332,549	395,142303	228,135712	1948,3715	50,06348	-95,065331
366	24-06-2021 11:00:25000	1255,9556	413,438477	1322,254	396,041809	228,655045	1928,9934	50,077488	-94,985947
367	24-06-2021 11:00:30000	1250,5581	406,636963	1315,0092	396,175293	228,732101	1917,7135	50,119255	-95,098808
368	24-06-2021 11:00:35000	1259,0271	413,451385	1325,1759	395,464905	228,32196	1936,0688	50,118332	-95,008293
369	24-06-2021 11:00:40000	1269,5508	412,733063	1334,9561	395,270325	228,209625	1951,3237	50,075958	-95,100563
370	24-06-2021 11:00:45000	1262,5779	397,569366	1323,6934	395,705414	228,460815	1932,7529	50,046452	-95,38295
371	24-06-2021 11:00:50000	1251,2554	403,401794	1314,6761	396,287415	228,796844	1916,6838	50,078728	-95,175949
372	24-06-2021 11:00:55000	1253,3163	415,829102	1320,4982	396,045288	228,657059	1926,3888	50,102757	-94,912376
373	24-06-2021 11:01:00000	1265,0895	407,966644	1329,2434	395,733246	228,476898	1940,575	50,070873	-95,173645
374	24-06-2021 11:01:05000	1267,9348	398,41983	1329,0586	395,619659	228,411331	1940,8867	50,040634	-95,400963
375	24-06-2021 11:01:10000	1254,5824	411,241669	1320,2638	395,953735	228,604187	1926,4904	50,064011	-95,025124
376	24-06-2021 11:01:15000	1257,1638	412,374359	1323,0697	395,523926	228,356033	1932,8174	50,072334	-95,018715
377	24-06-2021 11:01:20000	1263,7332	399,007202	1325,2277	395,536072	228,363052	1935,8176	50,059189	-95,359703
378	24-06-2021 11:01:25000	1260,5038	416,498322	1327,5319	395,528534	228,358688	1939,1383	50,063225	-94,950935
379	24-06-2021 11:01:30000	1260,2123	404,781128	1323,6249	395,503784	228,344391	1933,5493	50,066471	-95,209175
380	24-06-2021 11:01:35000	1262,7769	408,617554	1327,2429	395,19873	228,168274	1940,3411	50,057369	-95,14286
381	24-06-2021 11:01:40000	1263,885	410,388031	1328,843	395,570587	228,382965	1940,8815	50,038914	-95,111687
382	24-06-2021 11:01:45000	1250,3296	397,855133	1312,1024	395,777527	228,502457	1915,7416	50,069355	-95,292068
383	24-06-2021 11:01:50000	1256,2317	409,567078	1321,3112	395,465729	228,322433	1930,3987	50,085102	-95,074623
384	24-06-2021 11:01:55000	1269,3832	405,112061	1332,4598	394,657013	227,855515	1950,7428	50,047417	-95,266144
385	24-06-2021 11:02:00000	1266,9922	401,96637	1329,2277	394,804504	227,940674	1945,3215	50,014622	-95,317924
386	24-06-2021 11:02:05000	1267,6394	404,771851	1330,6953	394,983734	228,044174	1946,4415	49,988392	-95,261436

387	24-06-2021 11:02:10000	1265,2479	415,4198	1331,7004	394,898987	227,995209	1948,3877	49,969418	-95,009956
388	24-06-2021 11:02:15000	1255,757	406,186401	1319,8156	395,2547	228,200592	1929,4032	49,98069	-95,1464
389	24-06-2021 11:02:20000	1247,2833	403,858307	1311,0367	395,512238	228,349289	1915,3679	50,041634	-95,137177
390	24-06-2021 11:02:25000	1255,3665	410,452759	1320,7634	395,066467	228,091919	1931,6918	50,067814	-95,048538
391	24-06-2021 11:02:30000	1268,3256	405,737091	1331,6427	394,873352	227,980423	1948,4298	50,036549	-95,245186
392	24-06-2021 11:02:35000	1257,5187	412,487701	1323,4421	395,382294	228,274261	1933,7915	50,050991	-95,018784
393	24-06-2021 11:02:40000	1260,7478	414,759552	1327,2192	395,14093	228,134918	1940,63	50,044632	-94,991684
394	24-06-2021 11:02:45000	1265,1997	397,032104	1326,0334	394,954987	228,027557	1939,8273	50,022861	-95,412346
395	24-06-2021 11:02:50000	1259,8065	411,462036	1325,2975	394,843964	227,963455	1939,2823	50,007065	-95,058395
396	24-06-2021 11:02:55000	1260,9406	406,6987	1324,9056	395,077576	228,098343	1937,6733	50,001675	-95,172104
397	24-06-2021 11:03:00000	1250,0178	404,24472	1313,7573	395,415894	228,293671	1919,5979	50,03373	-95,1483
398	24-06-2021 11:03:05000	1260,3551	404,577698	1323,6986	394,885193	227,987259	1936,691	50,043007	-95,214653
399	24-06-2021 11:03:10000	1251,9595	409,600128	1317,2603	395,099762	228,111145	1926,2958	50,06559	-95,042679
400	24-06-2021 11:03:15000	1255,6134	406,968018	1319,9197	395,170685	228,152084	1929,7175	50,072342	-95,128014
401	24-06-2021 11:03:20000	1264,7698	406,749786	1328,5662	394,561829	227,800568	1945,3932	50,052956	-95,198105
402	24-06-2021 11:03:25000	1262,0232	400,798553	1324,1382	394,774384	227,923294	1937,8032	50,043411	-95,309021
403	24-06-2021 11:03:30000	1261,4227	408,982117	1326,0669	394,978058	228,040878	1939,7775	50,028397	-95,125114
404	24-06-2021 11:03:35000	1256,0859	416,209808	1323,2469	395,107544	228,115646	1934,8843	50,02737	-94,92453
405	24-06-2021 11:03:40000	1251,4374	400,033508	1313,8198	395,698364	228,456741	1918,2709	50,055328	-95,251831
406	24-06-2021 11:03:45000	1264,2567	403,856323	1327,1943	394,849884	227,966888	1942,0969	50,047531	-95,257843
407	24-06-2021 11:03:50000	1273,73	409,497986	1337,9374	394,54068	227,788361	1959,3164	49,983562	-95,201012
408	24-06-2021 11:03:55000	1264,3911	410,922455	1329,4895	394,90799	228,000443	1944,9916	49,967613	-95,103508
409	24-06-2021 11:04:00000	1250,3859	415,205017	1317,5205	395,415833	228,293625	1925,0625	49,995144	-94,90448
410	24-06-2021 11:04:05000	1259,0164	406,962616	1323,1555	394,926056	228,010864	1935,7112	50,018772	-95,15255
411	24-06-2021 11:04:10000	1257,0575	402,790344	1320,0127	394,787903	227,931091	1931,7775	50,019371	-95,230713
412	24-06-2021 11:04:15000	1252,8839	405,148407	1316,7625	395,237335	228,190567	1924,7932	50,047153	-95,148819
413	24-06-2021 11:04:20000	1260,0885	408,673676	1324,7025	394,887665	227,988693	1938,1	50,054165	-95,12236
414	24-06-2021 11:04:25000	1261,1836	386,664429	1319,1261	395,986359	228,623032	1925,0529	50,057297	-95,607513
415	24-06-2021 11:04:30000	1258,6482	403,936157	1321,8773	396,420135	228,873459	1927,163	50,059605	-95,216713
416	24-06-2021 11:04:35000	1260,3833	399,294495	1322,1204	396,159607	228,723068	1928,6079	50,067844	-95,330452

417	24-06-2021 11:04:40000	1256,4894	402,026733	1319,2389	396,536285	228,940536	1922,7543	50,057018	-95,243515
418	24-06-2021 11:04:45000	1257,5903	404,492615	1321,0404	396,602539	228,978775	1924,9722	50,0639	-95,19696
419	24-06-2021 11:04:50000	1253,4038	403,370026	1316,7112	396,480621	228,908386	1919,2852	50,086113	-95,192001
420	24-06-2021 11:04:55000	1259,1744	384,276123	1316,5062	396,152771	228,719116	1920,6609	50,079765	-95,645164
421	24-06-2021 11:05:00000	1260,1755	398,240021	1321,6041	396,390045	228,85611	1926,7845	50,073151	-95,351967
422	24-06-2021 11:05:05000	1259,6493	405,497833	1323,3082	396,537109	228,94101	1928,7147	50,066635	-95,189407
423	24-06-2021 11:05:10000	1266,7012	396,787689	1327,3931	395,86676	228,553986	1937,9757	50,043034	-95,427742
424	24-06-2021 11:05:15000	1267,0375	403,206909	1329,6465	395,89389	228,569656	1941,1165	49,997074	-95,291306
425	24-06-2021 11:05:20000	1264,2799	401,615601	1326,5363	396,263123	228,782822	1934,7627	49,976433	-95,306839
426	24-06-2021 11:05:25000	1258,1304	395,419647	1318,8058	396,223053	228,759705	1923,4963	49,984657	-95,399216
427	24-06-2021 11:05:30000	1249,196	403,202637	1312,655	396,74588	229,061539	1912,0139	50,033791	-95,165604
428	24-06-2021 11:05:35000	1251,613	398,915894	1313,6473	396,364594	228,841415	1915,3159	50,078854	-95,27771
429	24-06-2021 11:05:40000	1257,1693	403,6315	1320,3761	396,122253	228,701492	1926,3176	50,085392	-95,212967
430	24-06-2021 11:05:45000	1258,1029	390,465454	1317,3025	396,412079	228,86882	1920,3884	50,091682	-95,505989
431	24-06-2021 11:05:50000	1258,9897	408,867371	1323,7173	396,392242	228,857346	1930,0795	50,098896	-95,110161
432	24-06-2021 11:05:55000	1270,4563	396,009918	1330,7452	395,936676	228,59436	1942,2687	50,055698	-95,469528
433	24-06-2021 11:06:00000	1259,2245	391,889557	1318,7963	396,549591	228,948212	1921,9554	50,047558	-95,482864
434	24-06-2021 11:06:05000	1252,662	401,939209	1315,5673	396,477509	228,906601	1917,5929	50,071388	-95,218391
435	24-06-2021 11:06:10000	1260,1521	391,058868	1319,4355	396,156342	228,721176	1924,724	50,075871	-95,506905
436	24-06-2021 11:06:15000	1258,4482	409,074219	1323,2664	396,316681	228,813751	1929,5234	50,076294	-95,101662
437	24-06-2021 11:06:20000	1259,072	399,521149	1320,9388	396,419617	228,873169	1925,8187	50,076874	-95,316444
438	24-06-2021 11:06:25000	1268,5964	403,922058	1331,3489	395,885834	228,565002	1943,4196	50,032219	-95,286545
439	24-06-2021 11:06:30000	1255,1489	412,914978	1321,3242	396,342499	228,828659	1926,5875	50,023289	-94,991745
440	24-06-2021 11:06:35000	1255,5353	383,132507	1312,6917	396,223511	228,759964	1914,7639	50,050045	-95,645866
441	24-06-2021 11:06:40000	1257,675	410,948303	1323,1118	396,193573	228,742676	1929,8202	50,065784	-95,054321
442	24-06-2021 11:06:45000	1252,839	401,636871	1315,6434	396,369263	228,844101	1918,1898	50,085743	-95,226334
443	24-06-2021 11:06:50000	1261,8344	402,932373	1324,6058	396,08313	228,678909	1932,725	50,07217	-95,261124
444	24-06-2021 11:06:55000	1267,2931	388,419006	1325,4814	395,886749	228,565536	1934,9747	50,053001	-95,610023
445	24-06-2021 11:07:00000	1259,4238	406,847931	1323,5082	396,315582	228,81311	1930,0192	50,042583	-95,158005
446	24-06-2021 11:07:05000	1260,0696	406,250244	1323,9391	396,117859	228,698944	1931,7285	50,037174	-95,175797

447	24-06-2021 11:07:10000	1254,1404	388,037903	1312,7991	396,396362	228,859741	1914,0276	50,065159	-95,531784
448	24-06-2021 11:07:15000	1248,2394	404,382935	1312,1079	396,83728	229,114304	1910,8473	50,103428	-95,13237
449	24-06-2021 11:07:20000	1265,1804	393,161072	1324,8611	396,070831	228,671799	1933,0889	50,086514	-95,495323
450	24-06-2021 11:07:25000	1267,2344	402,873779	1329,7332	396,023682	228,644577	1940,4561	50,059494	-95,299904
451	24-06-2021 11:07:30000	1257,132	397,658936	1318,527	396,711273	229,041565	1920,8231	50,066994	-95,343666
452	24-06-2021 11:07:35000	1265,7191	401,351929	1327,8284	395,755127	228,489532	1939,0769	50,042191	-95,322495
453	24-06-2021 11:07:40000	1272,7888	396,17395	1333,0211	395,677307	228,444595	1947,1583	49,994759	-95,481522
454	24-06-2021 11:07:45000	1264,7094	397,159912	1325,6039	395,93338	228,592422	1935,108	49,983429	-95,406281
455	24-06-2021 11:07:50000	1258,0519	400,301208	1320,2029	395,995972	228,628555	1926,9063	49,994179	-95,292313
456	24-06-2021 11:07:55000	1250,7697	398,68335	1312,7732	396,08252	228,678543	1915,6523	50,042702	-95,276909
457	24-06-2021 11:08:00000	1255,5331	397,003967	1316,8051	396,322083	228,816833	1920,4219	50,07233	-95,346924
458	24-06-2021 11:08:05000	1262,5732	396,675934	1323,4209	395,846497	228,542282	1932,2286	50,065125	-95,402245
459	24-06-2021 11:08:10000	1254,7142	397,720886	1316,2407	396,342255	228,828476	1919,7657	50,086464	-95,325584
460	24-06-2021 11:08:15000	1257,2721	394,985352	1317,8568	395,85675	228,548187	1924,1277	50,101391	-95,402786
461	24-06-2021 11:08:20000	1262,5188	395,381287	1322,9814	396,163818	228,725494	1930,1953	50,085262	-95,429817
462	24-06-2021 11:08:25000	1258,9891	395,090607	1319,5266	396,44989	228,89064	1923,709	50,075794	-95,412193
463	24-06-2021 11:08:30000	1252,3489	393,510254	1312,7178	396,696228	229,032852	1912,7198	50,08456	-95,401222
464	24-06-2021 11:08:35000	1262,2047	402,807312	1324,9205	396,571106	228,960632	1930,9358	50,075214	-95,266449
465	24-06-2021 11:08:40000	1265,9423	393,562561	1325,7079	396,634003	228,996948	1931,8538	50,055416	-95,491798
466	24-06-2021 11:08:45000	1255,47	399,042572	1317,361	396,846863	229,119827	1918,6123	50,068874	-95,301903
467	24-06-2021 11:08:50000	1259,8707	402,262482	1322,5315	396,520172	228,931213	1927,6982	50,066677	-95,262062
468	24-06-2021 11:08:55000	1264,6666	398,890381	1326,0825	396,240356	228,769669	1934,3661	50,049217	-95,368614
469	24-06-2021 11:09:00000	1261,7047	404,29068	1324,8961	396,358734	228,838013	1931,9551	50,044426	-95,230461
470	24-06-2021 11:09:05000	1260,9313	395,87677	1321,615	396,085724	228,680405	1928,5814	50,041641	-95,408371
471	24-06-2021 11:09:10000	1249,2819	396,50885	1310,6962	396,617188	228,987213	1910,0394	50,080814	-95,314377
472	24-06-2021 11:09:15000	1255,4501	405,87207	1319,4268	396,466156	228,900024	1923,5852	50,124622	-95,151176
473	24-06-2021 11:09:20000	1262,1887	401,954834	1324,6465	396,056915	228,663757	1933,1104	50,116825	-95,284958
474	24-06-2021 11:09:25000	1267,0695	396,860016	1327,766	396,176422	228,732742	1936,9838	50,093388	-95,428665
475	24-06-2021 11:09:30000	1253,6179	400,702026	1316,1003	397,178009	229,31102	1915,3622	50,107281	-95,252457
476	24-06-2021 11:09:35000	1258,9921	403,255615	1321,9969	396,727356	229,050842	1926,1107	50,110874	-95,234108

477	24-06-2021 11:09:40000	1266,1511	398,567017	1327,4012	396,397675	228,860489	1935,7347	50,092899	-95,385704
478	24-06-2021 11:09:45000	1265,8618	398,726837	1327,1733	396,725372	229,049683	1933,671	50,069038	-95,380287
479	24-06-2021 11:09:50000	1256,8408	404,371307	1320,2897	396,905701	229,153793	1922,7234	50,083145	-95,194321
480	24-06-2021 11:09:55000	1253,1361	398,033691	1314,8312	397,082336	229,255783	1914,0529	50,107731	-95,307762
481	24-06-2021 11:10:00000	1251,4261	398,308136	1313,2848	397,029816	229,225449	1911,9882	50,139488	-95,28978
482	24-06-2021 11:10:05000	1262,7046	393,94455	1322,7302	396,911682	229,157257	1926,23	50,127373	-95,46199
483	24-06-2021 11:10:10000	1256,7278	400,350677	1318,9562	397,156403	229,298553	1919,7572	50,132248	-95,281998
484	24-06-2021 11:10:15000	1262,3707	403,91507	1325,4159	396,606567	228,981079	1931,7467	50,119061	-95,24337
485	24-06-2021 11:10:20000	1262,391	405,52475	1325,9266	396,756561	229,067688	1931,7249	50,104111	-95,208214
486	24-06-2021 11:10:25000	1261,5813	400,658447	1323,6744	396,603424	228,979279	1929,2561	50,091972	-95,309021
487	24-06-2021 11:10:30000	1252,5042	387,870209	1311,1865	397,709015	229,617599	1905,6984	50,110783	-95,52449
488	24-06-2021 11:10:35000	1241,8518	398,717987	1304,2899	397,795685	229,667633	1895,1797	50,204872	-95,212875
489	24-06-2021 11:10:40000	1273,6012	407,817322	1337,3014	396,697449	229,033569	1948,5657	50,162338	-95,236664
490	24-06-2021 11:10:45000	1268,4532	402,568878	1330,8025	397,142639	229,290604	1936,8783	50,122078	-95,314911
491	24-06-2021 11:10:50000	1256,6543	393,57074	1316,8439	397,465149	229,476791	1915,0846	50,141495	-95,429253
492	24-06-2021 11:10:55000	1249,9607	404,903717	1313,9059	397,668671	229,594299	1910,0238	50,164146	-95,133194
493	24-06-2021 11:11:00000	1254,5155	403,373779	1317,7708	397,306213	229,385025	1917,2366	50,177994	-95,199837
494	24-06-2021 11:11:05000	1269,7579	395,379089	1329,8909	396,779755	229,081085	1937,3167	50,142551	-95,478355
495	24-06-2021 11:11:10000	1261,327	403,78717	1324,3828	397,263306	229,360275	1926,9894	50,128613	-95,238853
496	24-06-2021 11:11:15000	1258,83	401,446838	1321,2919	397,60672	229,558533	1920,8706	50,139904	-95,272659
497	24-06-2021 11:11:20000	1252,2657	397,031769	1313,6985	397,538849	229,519348	1910,1832	50,163712	-95,323677
498	24-06-2021 11:11:25000	1259,233	397,437927	1320,4639	396,82489	229,107132	1923,3829	50,175716	-95,36293
499	24-06-2021 11:11:30000	1270,2782	394,880341	1330,2394	396,413544	228,869644	1939,6707	50,118801	-95,492439
500	24-06-2021 11:11:35000	1266,7024	395,66275	1327,0584	396,877502	229,137527	1932,7869	50,083115	-95,451897
501	24-06-2021 11:11:40000	1262,9889	406,103851	1326,673	396,904083	229,152863	1932,1003	50,072117	-95,199715
502	24-06-2021 11:11:45000	1254,3784	395,967346	1315,3917	396,941559	229,1745	1915,5686	50,087341	-95,361588
503	24-06-2021 11:11:50000	1257,0688	404,105927	1320,4255	397,084015	229,256729	1922,4581	50,104889	-95,201797
504	24-06-2021 11:11:55000	1250,6412	400,468353	1313,1938	396,745056	229,06105	1913,3066	50,133221	-95,236595
505	24-06-2021 11:12:00000	1256,6643	395,925507	1317,5593	397,028931	229,22493	1918,2858	50,152294	-95,378204
506	24-06-2021 11:12:05000	1261,2297	403,492157	1324,2002	396,665497	229,015121	1929,7246	50,149834	-95,244637

507	24-06-2021 11:12:10000	1259,704	392,04657	1319,3008	396,791016	229,08757	1922,032	50,151398	-95,482697
508	24-06-2021 11:12:15000	1263,5845	406,723236	1327,4297	396,807678	229,097198	1933,7291	50,127487	-95,190315
509	24-06-2021 11:12:20000	1255,7211	403,542389	1318,97	397,147827	229,293594	1919,839	50,135765	-95,204674
510	24-06-2021 11:12:25000	1252,974	404,299042	1316,587	397,340454	229,404816	1915,3018	50,156521	-95,168335
511	24-06-2021 11:12:30000	1265,1318	398,757782	1326,4866	396,470978	228,902817	1934,1265	50,145744	-95,374649
512	24-06-2021 11:12:35000	1264,5347	399,739563	1326,2125	396,482086	228,909225	1933,6096	50,116348	-95,349319
513	24-06-2021 11:12:40000	1265,7759	410,275146	1330,6068	396,7612	229,070374	1938,5435	50,09132	-95,127724
514	24-06-2021 11:12:45000	1257,8342	398,503387	1319,4513	396,954926	229,18222	1921,4248	50,101925	-95,330093
515	24-06-2021 11:12:50000	1259,6724	398,07196	1321,0737	396,506378	228,923248	1925,9517	50,097691	-95,352165
516	24-06-2021 11:12:55000	1257,1467	402,635284	1320,0505	396,729828	229,052246	1923,3335	50,102829	-95,234749
517	24-06-2021 11:13:00000	1258,0594	400,884033	1320,387	396,763031	229,071426	1923,8073	50,126499	-95,27961
518	24-06-2021 11:13:05000	1259,1835	404,339905	1322,5105	396,667358	229,01619	1927,2207	50,123314	-95,211609
519	24-06-2021 11:13:10000	1263,4186	391,752502	1322,761	396,605469	228,980469	1927,9205	50,10181	-95,513748
520	24-06-2021 11:13:15000	1257,0863	409,00061	1321,9484	397,022705	229,221359	1924,6866	50,10614	-95,093452
521	24-06-2021 11:13:20000	1259,2172	397,692963	1320,5255	397,091949	229,261337	1922,2485	50,116638	-95,357277
522	24-06-2021 11:13:25000	1258,323	399,818939	1320,3152	396,894501	229,147324	1922,9716	50,122715	-95,304749
523	24-06-2021 11:13:30000	1257,9087	403,931915	1321,1719	396,755707	229,0672	1924,7694	50,124081	-95,211578
524	24-06-2021 11:13:35000	1259,722	399,622589	1321,589	395,312347	228,233871	1931,6639	50,119465	-95,318733
525	24-06-2021 11:13:40000	1257,78	407,487946	1322,141	395,080994	228,100311	1933,6072	50,103886	-95,132057
526	24-06-2021 11:13:45000	1254,1444	415,257721	1321,1045	395,363983	228,263672	1930,7341	50,115742	-94,931503
527	24-06-2021 11:13:50000	1258,2897	404,30954	1321,6501	395,033264	228,072754	1933,1161	50,11824	-95,205956
528	24-06-2021 11:13:55000	1260,8008	407,651062	1325,0653	395,061279	228,088928	1938,0466	50,103371	-95,150085
529	24-06-2021 11:14:00000	1256,1614	409,101807	1321,1002	395,237579	228,190704	1931,4082	50,11026	-95,084488
530	24-06-2021 11:14:05000	1255,9637	401,24408	1318,4998	395,447723	228,312027	1926,4989	50,120514	-95,257027
531	24-06-2021 11:14:10000	1257,3928	411,740509	1323,09	395,119751	228,122665	1934,7645	50,122433	-95,034569
532	24-06-2021 11:14:15000	1261,0433	398,196228	1322,4183	395,18631	228,161102	1933,5712	50,110287	-95,358871
533	24-06-2021 11:14:20000	1255,3016	411,231842	1320,9443	395,587524	228,392746	1929,3373	50,118832	-95,030624
534	24-06-2021 11:14:25000	1257,1307	409,289551	1322,0801	395,426697	228,299881	1931,7778	50,124619	-95,087341
535	24-06-2021 11:14:30000	1255,2076	404,434387	1318,7545	395,359467	228,261063	1927,2543	50,139889	-95,181297
536	24-06-2021 11:14:35000	1254,4762	415,399048	1321,4639	395,359192	228,26091	1931,2728	50,157444	-94,930794

537	24-06-2021 11:14:40000	1267,1099	405,294434	1330,35	394,860199	227,972839	1946,6627	50,130402	-95,246361
538	24-06-2021 11:14:45000	1258,769	404,574677	1322,1876	395,121857	228,123901	1933,3888	50,130569	-95,203514
539	24-06-2021 11:14:50000	1258,5847	408,319122	1323,1628	395,378357	228,271988	1933,7058	50,139668	-95,119408
540	24-06-2021 11:14:55000	1255,204	415,681854	1322,2437	395,621399	228,412308	1931,0266	50,148907	-94,929848
541	24-06-2021 11:15:00000	1260,3636	403,879578	1323,4935	395,340576	228,250183	1934,3112	50,146156	-95,230057
542	24-06-2021 11:15:05000	1266,0494	403,328735	1328,7419	395,237457	228,190628	1942,4491	50,117023	-95,281815
543	24-06-2021 11:15:10000	1261,0623	409,974457	1326,0305	395,445984	228,311035	1937,554	50,100342	-95,10054
544	24-06-2021 11:15:15000	1262,3751	413,734863	1328,4454	395,181335	228,158234	1942,3082	50,079521	-95,026489
545	24-06-2021 11:15:20000	1251,5798	408,09021	1316,4307	395,871246	228,556549	1921,4852	50,095852	-95,073738
546	24-06-2021 11:15:25000	1253,7091	413,390564	1320,1053	395,445831	228,310944	1928,8971	50,103767	-94,970375
547	24-06-2021 11:15:30000	1257,8109	406,384644	1321,8307	395,576935	228,386627	1930,8049	50,101662	-95,156723
548	24-06-2021 11:15:35000	1254,6661	403,72934	1318,0229	395,492249	228,337738	1925,6161	50,117542	-95,193039
549	24-06-2021 11:15:40000	1262,3297	403,342041	1325,2023	395,29718	228,225113	1937,0338	50,10593	-95,255623
550	24-06-2021 11:15:45000	1263,6572	401,199799	1325,817	395,170197	228,151794	1938,8833	50,090908	-95,311584
551	24-06-2021 11:15:50000	1249,8261	412,863525	1316,2528	395,685242	228,449158	1922,0884	50,112606	-94,953346
552	24-06-2021 11:15:55000	1250,8018	407,540253	1315,5205	395,867798	228,55455	1920,2509	50,145916	-95,080376
553	24-06-2021 11:16:00000	1253,8606	415,342987	1320,8621	395,644012	228,425354	1929,0743	50,150475	-94,927452
554	24-06-2021 11:16:05000	1263,718	406,447052	1327,472	395,377899	228,271729	1940,3514	50,139153	-95,197327
555	24-06-2021 11:16:10000	1267,6063	412,165436	1332,9315	395,485016	228,333557	1947,5608	50,105331	-95,099144
556	24-06-2021 11:16:15000	1255,3082	406,946777	1319,6229	395,786591	228,507675	1926,5074	50,110825	-95,126289
557	24-06-2021 11:16:20000	1252,6436	405,45343	1316,6276	395,536774	228,363434	1923,3971	50,127209	-95,140305
558	24-06-2021 11:16:25000	1253,4177	401,88382	1316,27	395,692566	228,453384	1922,1221	50,155537	-95,224976
559	24-06-2021 11:16:30000	1253,9855	402,323334	1316,9448	395,587982	228,393021	1923,6128	50,172794	-95,219292
560	24-06-2021 11:16:35000	1268,2927	410,781158	1333,1571	395,045166	228,079605	1950,0153	50,132629	-95,134537
561	24-06-2021 11:16:40000	1262,2854	404,142975	1325,4041	395,729889	228,47493	1935,2423	50,115025	-95,237778
562	24-06-2021 11:16:45000	1252,4131	416,196014	1319,7567	396,09256	228,684311	1925,2242	50,126888	-94,89727
563	24-06-2021 11:16:50000	1260,5592	402,557709	1323,2771	395,706879	228,461655	1932,2457	50,118668	-95,260414
564	24-06-2021 11:16:55000	1250,5845	411,49588	1316,5449	396,065887	228,66893	1920,6295	50,134094	-94,989883
565	24-06-2021 11:17:00000	1253,7627	410,336029	1319,203	395,91391	228,581192	1925,2655	50,152733	-95,039406
566	24-06-2021 11:17:05000	1264,7532	403,890594	1327,6779	395,587494	228,392731	1939,2374	50,144405	-95,260551



567	24-06-2021 11:17:10000	1258,4694	406,767731	1322,5752	395,695251	228,454941	1931,2277	50,124329	-95,152954
568	24-06-2021 11:17:15000	1258,6652	408,709015	1323,3596	395,872437	228,557236	1931,6334	50,118038	-95,111336
569	24-06-2021 11:17:20000	1261,7372	400,289948	1323,7117	395,864441	228,552628	1932,1727	50,113373	-95,318123
570	24-06-2021 11:17:25000	1258,4469	409,30423	1323,3362	395,726349	228,4729	1932,217	50,116428	-95,096542
571	24-06-2021 11:17:30000	1260,7771	411,980865	1326,3811	395,867126	228,554169	1935,9978	50,109531	-95,053902
572	24-06-2021 11:17:35000	1247,6664	403,92865	1311,4229	396,210205	228,752243	1912,465	50,143368	-95,138382
573	24-06-2021 11:17:40000	1257,1952	411,085999	1322,6985	395,632751	228,418854	1931,7976	50,161388	-95,047745
574	24-06-2021 11:17:45000	1256,7161	409,263916	1321,6779	395,377716	228,271606	1931,4995	50,151306	-95,0849
575	24-06-2021 11:17:50000	1258,0963	403,033783	1321,0762	395,542358	228,366669	1929,8522	50,153366	-95,232674
576	24-06-2021 11:17:55000	1265,674	403,526123	1328,4442	395,39032	228,2789	1941,3131	50,126472	-95,27491
577	24-06-2021 11:18:00000	1263,3262	408,865173	1327,8417	395,414948	228,293106	1940,5016	50,095585	-95,141319
578	24-06-2021 11:18:05000	1255,4344	404,005127	1318,8389	396,111084	228,695023	1923,8696	50,100517	-95,192413
579	24-06-2021 11:18:10000	1243,5813	407,111084	1308,5237	396,388885	228,855408	1907,4457	50,165157	-95,03698
580	24-06-2021 11:18:15000	1256,2611	409,491577	1321,3158	395,640015	228,423035	1929,7496	50,188194	-95,076523
581	24-06-2021 11:18:20000	1271,9495	385,879578	1329,1947	395,759583	228,492081	1941,0234	50,150974	-95,693237
582	24-06-2021 11:18:25000	1269,1279	400,326721	1330,7694	396,267761	228,785492	1940,8857	50,116325	-95,367981
583	24-06-2021 11:18:30000	1266,2931	394,645386	1326,3647	396,717346	229,045059	1932,3079	50,097527	-95,470963
584	24-06-2021 11:18:35000	1246,0734	404,544312	1310,0974	397,688171	229,60556	1904,0304	50,140728	-95,113037
585	24-06-2021 11:18:40000	1254,1139	388,361481	1312,8695	396,910187	229,156403	1911,5911	50,161865	-95,524643
586	24-06-2021 11:18:45000	1253,5486	403,113617	1316,7706	397,302673	229,38298	1915,4207	50,195759	-95,198715
587	24-06-2021 11:18:50000	1264,517	396,200378	1325,1331	396,758209	229,068634	1930,2461	50,187649	-95,425652
588	24-06-2021 11:18:55000	1261,5331	400,433868	1323,5607	397,07608	229,252167	1926,4408	50,188011	-95,313576
589	24-06-2021 11:19:00000	1258,2919	396,477386	1319,2773	397,192169	229,319199	1919,7485	50,180328	-95,377357
590	24-06-2021 11:19:05000	1254,485	392,87027	1314,5643	397,344971	229,40741	1912,0615	50,203552	-95,42971
591	24-06-2021 11:19:10000	1268,6202	399,335938	1329,9874	396,844391	229,118393	1936,9996	50,1716	-95,385887
592	24-06-2021 11:19:15000	1262,7167	402,401825	1325,285	397,031219	229,226273	1929,2	50,157795	-95,27887
593	24-06-2021 11:19:20000	1270,3071	389,439697	1328,6622	397,111969	229,272888	1933,7106	50,125725	-95,607979
594	24-06-2021 11:19:25000	1253,3406	405,041107	1317,1639	397,510529	229,502991	1915,1779	50,144104	-95,154488
595	24-06-2021 11:19:30000	1259,6434	400,09436	1321,657	396,894501	229,147308	1924,7523	50,148365	-95,307899
596	24-06-2021 11:19:35000	1264,2772	395,491852	1324,6926	396,831055	229,110703	1929,3709	50,137569	-95,439285

597	24-06-2021 11:19:40000	1261,9393	404,437134	1325,1642	396,662079	229,013138	1930,9285	50,140308	-95,228897
598	24-06-2021 11:19:45000	1259,5516	392,492706	1319,288	396,570343	228,960175	1922,7162	50,134445	-95,472076
599	24-06-2021 11:19:50000	1259,1903	393,650482	1319,2881	396,875122	229,136139	1921,283	50,137287	-95,444687
600	24-06-2021 11:19:55000	1261,8552	398,921997	1323,4113	396,923706	229,164185	1926,9996	50,131813	-95,348686
601	24-06-2021 11:20:00000	1255,2592	397,616699	1316,7288	397,268066	229,363007	1915,7079	50,146496	-95,331642
602	24-06-2021 11:20:05000	1260,5704	391,26059	1319,895	397,014435	229,216568	1921,5255	50,16201	-95,505363
603	24-06-2021 11:20:10000	1266,6987	407,109375	1330,5127	396,797546	229,091354	1938,0299	50,142414	-95,203812
604	24-06-2021 11:20:15000	1260,0094	390,876923	1319,2454	397,151733	229,295853	1919,9166	50,136608	-95,509857
605	24-06-2021 11:20:20000	1263,465	399,411743	1325,0938	397,124207	229,279953	1928,5757	50,1423	-95,349098
606	24-06-2021 11:20:25000	1259,9932	403,768585	1323,1069	397,259583	229,358124	1924,9808	50,145271	-95,229881
607	24-06-2021 11:20:30000	1263,3022	393,699463	1323,2279	396,815521	229,101746	1927,4413	50,129898	-95,47126
608	24-06-2021 11:20:35000	1261,5598	394,973877	1321,9446	396,871033	229,133789	1925,1947	50,119186	-95,432121
609	24-06-2021 11:20:40000	1257,5466	397,054474	1318,7402	397,033844	229,227768	1919,7327	50,121731	-95,359695
610	24-06-2021 11:20:45000	1258,9069	400,235931	1320,9978	396,841736	229,116867	1923,9415	50,12851	-95,29969
611	24-06-2021 11:20:50000	1255,6582	395,307709	1316,4139	397,105682	229,269257	1916,0521	50,144505	-95,38475
612	24-06-2021 11:20:55000	1254,6638	399,955933	1316,8698	397,082855	229,256073	1916,7795	50,164112	-95,276222
613	24-06-2021 11:21:00000	1264,8728	407,223053	1328,8092	396,654816	229,008942	1936,4432	50,155773	-95,188446
614	24-06-2021 11:21:05000	1259,7756	396,289581	1320,6362	396,834167	229,112488	1923,5417	50,15369	-95,391571
615	24-06-2021 11:21:10000	1256,5383	393,931702	1316,8412	397,114624	229,274429	1916,6528	50,166248	-95,420639
616	24-06-2021 11:21:15000	1261,7911	403,466003	1324,7269	396,981995	229,197861	1928,6171	50,148792	-95,249146
617	24-06-2021 11:21:20000	1260,4498	391,44455	1319,8344	397,20752	229,328064	1920,5026	50,142094	-95,50061
618	24-06-2021 11:21:25000	1259,441	392,317657	1319,1304	397,134888	229,286118	1919,807	50,144531	-95,475105
619	24-06-2021 11:21:30000	1259,9556	399,532867	1321,7847	397,078003	229,253281	1923,9919	50,141022	-95,322304
620	24-06-2021 11:21:35000	1266,5673	400,982086	1328,5251	396,735443	229,055496	1935,4174	50,132114	-95,336334
621	24-06-2021 11:21:40000	1266,4238	395,919891	1326,8693	396,969269	229,190506	1931,9302	50,106262	-95,444511
622	24-06-2021 11:21:45000	1253,6249	391,097687	1313,2147	397,075684	229,251938	1911,5903	50,127003	-95,462296
623	24-06-2021 11:21:50000	1259,364	399,593567	1321,2391	396,66333	229,01387	1925,158	50,129593	-95,316887
624	24-06-2021 11:21:55000	1260,7216	393,803284	1320,7952	396,720001	229,04657	1924,2412	50,117519	-95,451706
625	24-06-2021 11:22:00000	1261,5422	388,875458	1320,1185	396,938477	229,172714	1922,2584	50,116158	-95,562798
626	24-06-2021 11:22:05000	1262,5557	404,169189	1325,6696	397,033234	229,227432	1929,9258	50,105103	-95,239098

627	24-06-2021 11:22:10000	1258,1133	392,997131	1318,0651	396,845367	229,118942	1919,8364	50,102093	-95,451523
628	24-06-2021 11:22:15000	1262,8125	398,380524	1324,161	396,911163	229,156937	1928,3756	50,101669	-95,366989
629	24-06-2021 11:22:20000	1259,0917	403,423492	1322,1431	397,073029	229,250397	1924,4797	50,092525	-95,231117
630	24-06-2021 11:22:25000	1248,3287	389,276245	1307,6165	397,474945	229,482452	1901,3682	50,133965	-95,465973
631	24-06-2021 11:22:30000	1249,8342	404,109436	1313,541	397,413849	229,447159	1910,3184	50,177906	-95,149994
632	24-06-2021 11:22:35000	1261,3325	406,600861	1325,2488	396,978668	229,195938	1929,375	50,175438	-95,177048
633	24-06-2021 11:22:40000	1266,8647	395,362274	1327,1239	397,154602	229,297516	1931,4769	50,136127	-95,459427
634	24-06-2021 11:22:45000	1260,4492	393,304718	1320,3866	397,110321	229,271957	1921,9906	50,127911	-95,460617
635	24-06-2021 11:22:50000	1255,7177	394,040009	1316,0905	397,459808	229,473724	1914,0911	50,131496	-95,412712
636	24-06-2021 11:22:55000	1256,0078	398,195099	1317,6171	397,42215	229,451981	1916,2949	50,150352	-95,324188
637	24-06-2021 11:23:00000	1271,1147	392,382538	1330,2994	396,721008	229,047165	1938,2011	50,104919	-95,551018
638	24-06-2021 11:23:05000	1264,624	395,254089	1324,9528	397,331512	229,399658	1927,4327	50,074707	-95,446732
639	24-06-2021 11:23:10000	1253,6962	404,505646	1317,3379	397,714905	229,621002	1914,561	50,10881	-95,168922
640	24-06-2021 11:23:15000	1256,1012	397,276428	1317,4288	397,236725	229,34491	1916,968	50,126263	-95,344902
641	24-06-2021 11:23:20000	1263,0132	401,360596	1325,2521	397,25119	229,353271	1928,303	50,112019	-95,303635
642	24-06-2021 11:23:25000	1261,5463	399,850189	1323,3969	396,907379	229,154755	1927,3464	50,097694	-95,326378
643	24-06-2021 11:23:30000	1253,5767	385,183075	1311,4193	397,311981	229,388367	1907,9618	50,120159	-95,589317
644	24-06-2021 11:23:35000	1259,2393	401,18454	1321,6023	397,156067	229,298355	1923,4607	50,128937	-95,281258
645	24-06-2021 11:23:40000	1255,1359	400,944611	1317,62	397,349304	229,409927	1916,6403	50,14291	-95,257797
646	24-06-2021 11:23:45000	1257,6288	398,446136	1319,2382	397,118164	229,276443	1920,1512	50,151314	-95,329926
647	24-06-2021 11:23:50000	1264,2444	390,955017	1323,314	397,24939	229,352219	1925,4932	50,141724	-95,53624
648	24-06-2021 11:23:55000	1263,3772	402,775055	1326,0277	397,189545	229,317673	1929,6786	50,132763	-95,275322
649	24-06-2021 11:24:00000	1264,7808	401,123962	1326,8651	397,224274	229,337723	1930,8384	50,110096	-95,320984
650	24-06-2021 11:24:05000	1261,0376	400,077179	1322,9806	397,301636	229,382401	1924,7158	50,100632	-95,317924
651	24-06-2021 11:24:10000	1257,3804	394,732239	1317,8843	397,220215	229,335388	1917,7305	50,096123	-95,409012
652	24-06-2021 11:24:15000	1256,2612	394,910187	1316,8699	397,125916	229,280945	1916,649	50,108353	-95,397522
653	24-06-2021 11:24:20000	1251,1931	406,661377	1315,6206	397,539917	229,519958	1912,9196	50,145073	-95,102875
654	24-06-2021 11:24:25000	1254,7052	400,359192	1317,0317	397,186646	229,315994	1916,4938	50,169018	-95,267647
655	24-06-2021 11:24:30000	1262,4452	396,341492	1323,1985	397,055878	229,240509	1926,3064	50,167492	-95,4086
656	24-06-2021 11:24:35000	1260,5277	395,540588	1321,1293	397,276764	229,368027	1922,1643	50,159889	-95,412903

657	24-06-2021 11:24:40000	1272,8344	399,802948	1334,1476	396,543396	228,944626	1944,6338	50,12154	-95,40432
658	24-06-2021 11:24:45000	1261,2257	392,413666	1320,8629	397,77356	229,654861	1919,3695	50,09095	-95,484985
659	24-06-2021 11:24:50000	1240,2977	403,543243	1304,2952	398,224854	229,915405	1893,2405	50,162216	-95,093338
660	24-06-2021 11:24:55000	1261,212	404,475952	1324,4834	397,072754	229,250259	1927,8749	50,167683	-95,222931
661	24-06-2021 11:25:00000	1261,5291	393,980316	1321,6187	397,253815	229,354782	1922,9308	50,15456	-95,453331
662	24-06-2021 11:25:05000	1259,5243	394,561127	1319,8788	397,630066	229,572021	1918,6373	50,160271	-95,427269
663	24-06-2021 11:25:10000	1250,8154	403,226715	1314,2036	397,568604	229,536514	1910,6854	50,179726	-95,176689
664	24-06-2021 11:25:15000	1266,5341	390,390381	1325,3352	397,106354	229,269653	1929,0321	50,167217	-95,563309
665	24-06-2021 11:25:20000	1267,2181	407,444733	1331,1097	397,125366	229,28064	1937,4032	50,142216	-95,200127
666	24-06-2021 11:25:25000	1261,9163	401,097321	1324,1268	397,096008	229,263672	1927,2644	50,117722	-95,301773
667	24-06-2021 11:25:30000	1259,6228	398,874023	1321,2684	397,287048	229,373978	1922,2085	50,114819	-95,334366
668	24-06-2021 11:25:35000	1257,0481	396,79071	1318,1853	397,439789	229,462173	1917,0049	50,130569	-95,362007
669	24-06-2021 11:25:40000	1263,8026	403,350769	1326,608	396,820068	229,104355	1932,2736	50,121304	-95,265717
670	24-06-2021 11:25:45000	1269,6694	401,043793	1331,5017	396,837128	229,114227	1939,3427	50,080948	-95,356209
671	24-06-2021 11:25:50000	1251,8735	393,538116	1312,2727	397,293121	229,377487	1909,1493	50,103733	-95,397362
672	24-06-2021 11:25:55000	1254,8146	403,168488	1317,9926	397,070099	229,248718	1918,4769	50,131889	-95,206497
673	24-06-2021 11:26:00000	1261,9452	395,967682	1322,6096	396,761902	229,070786	1926,545	50,126225	-95,413284
674	24-06-2021 11:26:05000	1262,3186	401,149811	1324,5261	396,874481	229,135773	1928,8955	50,113049	-95,303413
675	24-06-2021 11:26:10000	1257,6437	400,101898	1319,7534	397,487427	229,489655	1918,9813	50,124805	-95,293839
676	24-06-2021 11:26:15000	1258,0485	391,087219	1317,4351	397,239624	229,346588	1916,6887	50,144047	-95,492256
677	24-06-2021 11:26:20000	1256,1942	409,004883	1321,1013	397,265686	229,361633	1921,9672	50,163681	-95,086891
678	24-06-2021 11:26:25000	1266,6207	396,61203	1327,2638	396,610474	228,983353	1934,2017	50,143391	-95,430969
679	24-06-2021 11:26:30000	1267,9446	390,545685	1326,7288	396,731995	229,053513	1932,6879	50,112705	-95,569237
680	24-06-2021 11:26:35000	1257,4363	406,854767	1321,619	396,921204	229,162735	1924,4895	50,117733	-95,143631
681	24-06-2021 11:26:40000	1265,1399	391,690399	1324,3868	396,726105	229,05011	1929,3866	50,104855	-95,526466
682	24-06-2021 11:26:45000	1271,106	399,445221	1332,3915	396,185944	228,738251	1943,8718	50,056904	-95,400345
683	24-06-2021 11:26:50000	1258,582	391,641083	1318,109	396,973694	229,193054	1919,0967	50,05928	-95,48391
684	24-06-2021 11:26:55000	1253,9497	400,311432	1316,2975	396,968445	229,190018	1916,4521	50,087479	-95,263397
685	24-06-2021 11:27:00000	1253,1812	410,36676	1318,6598	397,259705	229,358185	1918,4086	50,106525	-95,034447
686	24-06-2021 11:27:05000	1263,8511	397,710663	1324,9503	396,490448	228,914063	1931,3204	50,101933	-95,388565

687	24-06-2021 11:27:10000	1260,0243	394,688782	1320,394	396,823547	229,106384	1923,1554	50,096909	-95,427895
688	24-06-2021 11:27:15000	1252,8124	398,755646	1314,7415	397,041107	229,231979	1913,823	50,120056	-95,289642
689	24-06-2021 11:27:20000	1267,4014	402,569519	1329,8002	396,415192	228,870605	1938,9487	50,099049	-95,307655
690	24-06-2021 11:27:25000	1272,4718	391,343018	1331,2902	396,418945	228,872787	1940,8956	50,053764	-95,581841
691	24-06-2021 11:27:30000	1253,9543	397,085205	1315,3243	397,377686	229,4263	1913,1809	50,070499	-95,334229
692	24-06-2021 11:27:35000	1236,8732	406,929077	1302,0931	397,68338	229,602783	1892,3765	50,158855	-94,991142
693	24-06-2021 11:27:40000	1267,998	389,549805	1326,4871	396,316254	228,813477	1934,4381	50,149269	-95,590675
694	24-06-2021 11:27:45000	1270,6715	399,502563	1331,9941	396,300385	228,804337	1942,5421	50,095493	-95,396179
695	24-06-2021 11:27:50000	1264,6198	394,600281	1324,7538	396,594391	228,974075	1930,5415	50,056519	-95,460739
696	24-06-2021 11:27:55000	1262,0691	395,231628	1322,5077	397,007446	229,212555	1925,3901	50,051113	-95,430008
697	24-06-2021 11:28:00000	1252,76	404,682465	1316,5012	397,260376	229,358582	1915,2844	50,081062	-95,158287
698	24-06-2021 11:28:05000	1253,3656	393,130188	1313,5741	397,076538	229,252426	1911,9692	50,107777	-95,416443
699	24-06-2021 11:28:10000	1260,9476	402,303436	1323,5698	396,709106	229,040298	1928,2789	50,108887	-95,268692
700	24-06-2021 11:28:15000	1263,3036	393,173157	1323,0725	396,271027	228,787384	1929,6505	50,094997	-95,482559
701	24-06-2021 11:28:20000	1255,4491	392,273621	1315,3064	396,877045	229,137253	1915,4535	50,115234	-95,449173
702	24-06-2021 11:28:25000	1253,5585	395,538177	1314,4805	396,932739	229,169403	1914,0129	50,14098	-95,365303
703	24-06-2021 11:28:30000	1266,5211	395,140778	1326,7299	396,443573	228,886993	1934,1427	50,120468	-95,461876
704	24-06-2021 11:28:35000	1261,8406	385,111603	1319,2999	396,812042	229,099731	1921,6039	50,105644	-95,644699
705	24-06-2021 11:28:40000	1265,6985	411,109711	1330,7906	396,894653	229,147415	1937,9631	50,0975	-95,108757
706	24-06-2021 11:28:45000	1265,9849	397,966553	1327,0625	396,724762	229,049347	1933,3021	50,071537	-95,39753
707	24-06-2021 11:28:50000	1256,8979	391,124786	1316,3477	397,004059	229,210587	1916,2504	50,075356	-95,483742
708	24-06-2021 11:28:55000	1254,2284	402,671082	1317,2823	397,079041	229,253891	1917,3573	50,090652	-95,213326
709	24-06-2021 11:29:00000	1255,7258	396,649719	1316,882	396,832916	229,111786	1917,9738	50,109634	-95,35598
710	24-06-2021 11:29:05000	1259,8346	396,523712	1320,7627	396,622772	228,990448	1924,5978	50,110104	-95,386894
711	24-06-2021 11:29:10000	1267,403	398,327606	1328,5236	396,62677	228,992752	1935,8678	50,083935	-95,399353
712	24-06-2021 11:29:15000	1266,1267	400,403778	1327,9308	396,547791	228,947159	1935,5492	50,068157	-95,34584
713	24-06-2021 11:29:20000	1260,6012	399,436859	1322,371	396,924286	229,164536	1925,4733	50,058472	-95,328857
714	24-06-2021 11:29:25000	1258,2871	400,80719	1320,5806	396,527618	228,935516	1924,8406	50,065273	-95,282875
715	24-06-2021 11:29:30000	1262,9856	396,96225	1323,9001	396,527527	228,935455	1929,6343	50,045765	-95,398857
716	24-06-2021 11:29:35000	1249,6517	401,975647	1312,7123	397,028168	229,224503	1910,9742	50,070862	-95,196152

717	24-06-2021 11:29:40000	1254,2849	403,426971	1317,5675	396,472656	228,903778	1920,7614	50,089069	-95,197014
718	24-06-2021 11:29:45000	1251,2192	396,832428	1312,6406	397,026245	229,223389	1910,9255	50,115303	-95,32077
719	24-06-2021 11:29:50000	1259,3378	398,962494	1321,0233	396,680908	229,024017	1924,7426	50,122936	-95,330467
720	24-06-2021 11:29:55000	1262,2769	406,16391	1326,0134	396,573517	228,962021	1932,4105	50,119781	-95,193359
721	24-06-2021 11:30:00000	1267,2	407,216461	1331,0225	396,441711	228,88591	1940,6937	50,084057	-95,204994
722	24-06-2021 11:30:05000	1259,0592	395,451843	1319,7015	396,827393	229,108597	1922,1199	50,085114	-95,404839
723	24-06-2021 11:30:10000	1254,3862	397,828491	1315,9606	396,801453	229,093613	1916,696	50,098969	-95,320953
724	24-06-2021 11:30:15000	1261,7307	405,120544	1325,1744	396,52533	228,934189	1931,4017	50,098263	-95,212433
725	24-06-2021 11:30:20000	1269,4974	391,382019	1328,459	396,30722	228,808273	1937,3551	50,066486	-95,561646
726	24-06-2021 11:30:25000	1259,4662	397,495819	1320,7036	396,638794	228,99971	1924,3617	50,06921	-95,363274
727	24-06-2021 11:30:30000	1259,2174	399,933319	1321,2021	396,803986	229,095078	1924,3373	50,074661	-95,308456
728	24-06-2021 11:30:35000	1258,7467	401,299225	1321,1677	396,731567	229,053253	1924,651	50,082569	-95,275307
729	24-06-2021 11:30:40000	1259,6708	400,046295	1321,6685	396,738434	229,057236	1925,3455	50,081486	-95,309135
730	24-06-2021 11:30:45000	1260,0166	400,966461	1322,2767	396,669647	229,017517	1926,5468	50,08535	-95,291443
731	24-06-2021 11:30:50000	1258,1335	397,411652	1319,4075	396,718414	229,04567	1922,2279	50,081753	-95,355949
732	24-06-2021 11:30:55000	1254,1732	395,513153	1315,0594	396,835205	229,113098	1915,2764	50,095039	-95,370087
733	24-06-2021 11:31:00000	1261,0121	398,374786	1322,4425	396,51709	228,929428	1927,488	50,080051	-95,354782
734	24-06-2021 11:31:05000	1264,4001	400,475983	1326,3065	396,365906	228,842163	1933,963	50,054596	-95,332428
735	24-06-2021 11:31:10000	1260,9988	402,067963	1323,5469	396,632965	228,996323	1928,6454	50,044533	-95,2742
736	24-06-2021 11:31:15000	1255,52	394,83252	1316,1394	396,737549	229,056717	1917,4143	50,064228	-95,394142
737	24-06-2021 11:31:20000	1254,1421	404,095734	1317,6364	396,745972	229,061584	1919,4995	50,09359	-95,181198
738	24-06-2021 11:31:25000	1263,8733	401,687897	1326,1707	396,303192	228,805954	1934,0984	50,081436	-95,302452
739	24-06-2021 11:31:30000	1261,6335	400,913025	1323,8015	396,804535	229,095383	1928,254	50,076427	-95,303833
740	24-06-2021 11:31:35000	1261,52	399,127808	1323,1538	396,358307	228,837769	1929,3303	50,074043	-95,341911
741	24-06-2021 11:31:40000	1265,9287	403,948212	1328,8152	396,756073	229,067413	1935,6753	50,055054	-95,267479
742	24-06-2021 11:31:45000	1259,0139	396,366028	1319,9326	396,726715	229,050461	1922,8594	50,062378	-95,384712
743	24-06-2021 11:31:50000	1259,8671	409,739929	1324,8215	396,515839	228,928711	1931,0831	50,073963	-95,097122
744	24-06-2021 11:31:55000	1255,9027	388,600464	1314,6489	396,733765	229,054535	1915,1681	50,096199	-95,53141
745	24-06-2021 11:32:00000	1261,2487	401,521393	1323,6191	396,36438	228,841278	1930,0098	50,10479	-95,28788
746	24-06-2021 11:32:05000	1268,2169	393,493744	1327,8597	396,356323	228,836624	1936,2435	50,079906	-95,508347

747	24-06-2021 11:32:10000	1262,7067	389,098846	1321,2971	396,825592	229,107559	1924,438	50,06863	-95,565689
748	24-06-2021 11:32:15000	1260,2813	403,912079	1323,425	396,656677	229,01004	1928,3372	50,068169	-95,22876
749	24-06-2021 11:32:20000	1256,0654	403,729218	1319,355	396,891785	229,145767	1921,255	50,079674	-95,202988
750	24-06-2021 11:32:25000	1266,4597	399,611633	1328,0098	396,226654	228,761749	1937,0236	50,064251	-95,36525
751	24-06-2021 11:32:30000	1262,9319	393,211029	1322,729	396,490692	228,914185	1928,1821	50,052284	-95,479263
752	24-06-2021 11:32:35000	1258,2522	402,826172	1321,1614	396,510956	228,925888	1925,8154	50,057514	-95,238342
753	24-06-2021 11:32:40000	1260,4169	396,67688	1321,3641	396,50766	228,923981	1926,0996	50,060261	-95,38755
754	24-06-2021 11:32:45000	1256,8649	393,049927	1316,8893	396,530243	228,937042	1919,4487	50,064396	-95,441948
755	24-06-2021 11:32:50000	1259,5731	400,982361	1321,859	396,385529	228,85347	1927,3403	50,063931	-95,28801
756	24-06-2021 11:32:55000	1266,4122	398,817688	1327,7257	396,551544	228,949341	1935,205	50,038601	-95,382072
757	24-06-2021 11:33:00000	1251,0792	401,197449	1313,8334	396,974121	229,193298	1912,9343	50,059155	-95,223572
758	24-06-2021 11:33:05000	1253,9182	399,927734	1316,151	396,932098	229,169052	1916,3757	50,083511	-95,271622
759	24-06-2021 11:33:10000	1261,0243	389,320923	1319,7549	396,528015	228,93576	1923,5508	50,075642	-95,549881
760	24-06-2021 11:33:15000	1254,734	403,754974	1318,0953	396,970947	229,191483	1919,1653	50,087292	-95,192955
761	24-06-2021 11:33:20000	1256,2531	401,540833	1318,8657	396,951141	229,180038	1920,3831	50,10038	-95,252541
762	24-06-2021 11:33:25000	1262,26	391,59552	1321,6079	396,668701	229,016983	1925,7089	50,090572	-95,509422
763	24-06-2021 11:33:30000	1268,9232	394,508392	1328,8352	396,395081	228,858994	1937,6555	50,060684	-95,491394
764	24-06-2021 11:33:35000	1265,2023	404,579529	1328,3153	396,738556	229,057312	1935,2137	50,038513	-95,248642
765	24-06-2021 11:33:40000	1256,0887	397,42334	1317,4612	396,958252	229,184143	1918,4021	50,046452	-95,341606
766	24-06-2021 11:33:45000	1253,282	396,111481	1314,3896	397,113892	229,274002	1913,1123	50,076469	-95,350876
767	24-06-2021 11:33:50000	1252,3492	405,805206	1316,4561	396,969604	229,190704	1916,7991	50,10384	-95,130348
768	24-06-2021 11:33:55000	1258,2324	399,546234	1320,1462	396,704346	229,037552	1923,3895	50,111473	-95,310081
769	24-06-2021 11:34:00000	1267,9098	394,388794	1327,8319	396,567535	228,958572	1935,2659	50,076035	-95,487213
770	24-06-2021 11:34:05000	1258,5908	399,865601	1320,5845	397,071259	229,24939	1922,2855	50,074627	-95,305588
771	24-06-2021 11:34:10000	1259,3455	398,781738	1320,9762	396,799835	229,092682	1924,1422	50,075573	-95,334465
772	24-06-2021 11:34:15000	1265,3356	402,168884	1327,71	396,762909	229,071365	1934,198	50,050903	-95,302101
773	24-06-2021 11:34:20000	1254,6772	397,452148	1316,1244	397,203827	229,325928	1915,2894	50,068626	-95,331215
774	24-06-2021 11:34:25000	1254,2021	399,578735	1316,3154	397,29718	229,379822	1915,0571	50,097916	-95,281281
775	24-06-2021 11:34:30000	1249,1399	401,674622	1312,1329	397,176178	229,309967	1909,5687	50,138504	-95,199181
776	24-06-2021 11:34:35000	1265,6884	399,213684	1327,1543	396,609344	228,982712	1934,0164	50,122898	-95,368591

777	24-06-2021 11:34:40000	1267,8517	399,433228	1329,2836	396,820587	229,10466	1936,261	50,080917	-95,378571
778	24-06-2021 11:34:45000	1259,402	398,859344	1321,0533	397,276886	229,368118	1922,1091	50,067104	-95,33316
779	24-06-2021 11:34:50000	1257,9257	393,759003	1318,1135	397,344879	229,407364	1917,5502	50,067829	-95,433792
780	24-06-2021 11:34:55000	1261,5884	406,48877	1325,4578	396,745544	229,06134	1930,9427	50,059223	-95,181328
781	24-06-2021 11:35:00000	1256,4875	398,683258	1318,222	397,229706	229,340866	1918,1853	50,063122	-95,316841
782	24-06-2021 11:35:05000	1261,5623	400,847351	1323,7136	396,794006	229,08931	1928,2329	50,062939	-95,304764
783	24-06-2021 11:35:10000	1259,3431	400,947052	1321,6292	396,591888	228,972626	1926,0133	50,06493	-95,287178
784	24-06-2021 11:35:15000	1266,1309	403,380646	1328,8353	396,241241	228,770203	1938,1985	50,040516	-95,28125
785	24-06-2021 11:35:20000	1262,5198	398,277435	1323,8508	396,596649	228,975372	1929,2482	50,032944	-95,367218
786	24-06-2021 11:35:25000	1254,0529	399,14151	1316,0405	397,030731	229,225983	1915,746	50,047726	-95,289841
787	24-06-2021 11:35:30000	1247,7592	392,07312	1307,9084	397,303894	229,383713	1902,5742	50,092972	-95,401115
788	24-06-2021 11:35:35000	1251,587	399,55014	1313,8152	396,986511	229,200455	1912,7441	50,119041	-95,26355
789	24-06-2021 11:35:40000	1260,145	398,224945	1321,5706	396,731689	229,053345	1925,2103	50,109016	-95,352081
790	24-06-2021 11:35:45000	1260,6772	385,713776	1318,3634	397,53714	229,518372	1916,8151	50,108326	-95,624405
791	24-06-2021 11:35:50000	1244,9104	399,558899	1307,459	397,962219	229,763779	1898,8761	50,171932	-95,216011
792	24-06-2021 11:35:55000	1262,0399	401,348267	1324,3207	397,247498	229,351135	1926,7555	50,173359	-95,297157
793	24-06-2021 11:36:00000	1278,3531	396,403809	1338,4031	396,694336	229,031769	1949,9707	50,093437	-95,513313
794	24-06-2021 11:36:05000	1259,4575	394,182526	1319,7019	397,616577	229,56424	1918,3704	50,077095	-95,434998
795	24-06-2021 11:36:10000	1261,5015	392,093964	1321,0311	397,171997	229,307541	1922,4882	50,076591	-95,493683
796	24-06-2021 11:36:15000	1260,9379	399,817902	1322,807	396,860046	229,127441	1926,5392	50,067307	-95,322884
797	24-06-2021 11:36:20000	1264,1815	394,361572	1324,2644	396,816437	229,102264	1928,8096	50,04974	-95,462929
798	24-06-2021 11:36:25000	1258,0627	395,003052	1318,6166	397,050415	229,23735	1919,6033	50,058083	-95,407791
799	24-06-2021 11:36:30000	1260,7246	400,582794	1322,8353	396,94696	229,177628	1926,1595	50,049053	-95,304733
800	24-06-2021 11:36:35000	1261,1052	392,312378	1320,7178	396,893646	229,146851	1923,2882	50,039829	-95,486351
801	24-06-2021 11:36:40000	1254,2191	397,004883	1315,5525	396,934448	229,170395	1915,702	50,055901	-95,337822
802	24-06-2021 11:36:45000	1258,2633	394,691895	1318,7146	396,95697	229,183395	1920,1093	50,064087	-95,415894
803	24-06-2021 11:36:50000	1264,7576	394,108246	1324,7388	396,747803	229,062653	1929,8181	50,046329	-95,472221
804	24-06-2021 11:36:55000	1248,2159	392,929718	1308,6011	397,795563	229,667572	1901,3945	50,084591	-95,385521
805	24-06-2021 11:37:00000	1247,3246	402,445251	1310,6414	397,314026	229,389542	1906,5128	50,149895	-95,169022
806	24-06-2021 11:37:05000	1265,5476	404,243927	1328,542	396,688263	229,028259	1935,6223	50,140511	-95,258377



807	24-06-2021 11:37:10000	1274,5405	400,851746	1336,0897	396,361603	228,839676	1948,1801	50,073975	-95,393333
808	24-06-2021 11:37:15000	1268,4508	390,14328	1327,0942	396,935577	229,171066	1932,2682	50,036324	-95,581062
809	24-06-2021 11:37:20000	1260,1306	405,17099	1323,6664	397,281342	229,370682	1925,6421	50,038414	-95,200012
810	24-06-2021 11:37:25000	1261,0962	392,383789	1320,7303	396,940735	229,174042	1922,9729	50,046982	-95,484756
811	24-06-2021 11:37:30000	1255,8728	405,352753	1319,6694	397,014282	229,216492	1921,0718	50,057289	-95,16571
812	24-06-2021 11:37:35000	1256,1991	394,38031	1316,6517	396,925995	229,165527	1917,0968	50,071529	-95,4086
813	24-06-2021 11:37:40000	1260,7478	394,80545	1321,1194	396,965515	229,188339	1923,411	50,076839	-95,430275
814	24-06-2021 11:37:45000	1261,0549	398,751129	1322,5967	397,141449	229,289917	1925,0306	50,085453	-95,346901
815	24-06-2021 11:37:50000	1258,1908	396,585846	1319,2135	397,094025	229,262543	1920,0006	50,092365	-95,374306
816	24-06-2021 11:37:55000	1263,4729	395,656799	1323,9744	396,963135	229,186966	1927,7863	50,079536	-95,430313
817	24-06-2021 11:38:00000	1262,7507	399,480347	1324,4334	396,835571	229,113312	1928,9215	50,063759	-95,342712
818	24-06-2021 11:38:05000	1263,7011	397,38916	1324,7107	396,762573	229,071167	1929,6945	50,045082	-95,394493
819	24-06-2021 11:38:10000	1267,7343	405,261475	1330,9347	396,801697	229,093765	1938,6234	50,01852	-95,251427
820	24-06-2021 11:38:15000	1262,3367	399,826233	1324,1431	397,048035	229,235977	1927,4913	50,008087	-95,332344
821	24-06-2021 11:38:20000	1251,0289	400,139282	1313,4629	397,416779	229,448883	1910,1818	50,059025	-95,246613
822	24-06-2021 11:38:25000	1246,2223	397,459442	1308,0688	397,585083	229,546051	1901,5955	50,113029	-95,271919
823	24-06-2021 11:38:30000	1252,3497	398,113953	1314,106	397,153229	229,296707	1912,3446	50,143097	-95,300514
824	24-06-2021 11:38:35000	1261,3096	391,109558	1320,5562	396,832275	229,111404	1923,3347	50,140194	-95,513512
825	24-06-2021 11:38:40000	1271,6542	404,651154	1334,4839	396,59906	228,976761	1944,7122	50,100082	-95,291847
826	24-06-2021 11:38:45000	1264,7051	395,232025	1325,0236	397,214935	229,332336	1927,9805	50,077885	-95,447746
827	24-06-2021 11:38:50000	1253,673	397,689301	1315,2385	397,311188	229,387924	1913,262	50,100857	-95,319046
828	24-06-2021 11:38:55000	1264,5527	403,65976	1327,4166	396,658081	229,010834	1934,0693	50,086369	-95,264198
829	24-06-2021 11:39:00000	1260,8993	394,309326	1321,1157	397,188904	229,317322	1922,432	50,07967	-95,442001
830	24-06-2021 11:39:05000	1255,8209	390,67218	1315,1847	397,094879	229,263016	1914,2711	50,085384	-95,486275
831	24-06-2021 11:39:10000	1260,8989	397,73764	1322,1426	397,116394	229,275436	1924,2576	50,089104	-95,367836
832	24-06-2021 11:39:15000	1261,3479	397,385803	1322,4651	397,091827	229,261261	1924,7738	50,08989	-95,37854
833	24-06-2021 11:39:20000	1257,8315	397,606079	1319,1781	397,24469	229,349533	1919,3695	50,09341	-95,34964
834	24-06-2021 11:39:25000	1260,4752	395,958069	1321,2042	397,174133	229,308792	1922,656	50,094341	-95,403511
835	24-06-2021 11:39:30000	1256,2905	401,519226	1318,8948	397,246979	229,350845	1918,8157	50,10498	-95,253273
836	24-06-2021 11:39:35000	1255,5443	400,723328	1317,9419	397,282043	229,371078	1917,3822	50,120979	-95,265533

837	24-06-2021 11:39:40000	1261,9651	395,866577	1322,5983	397,057526	229,241455	1925,1736	50,116238	-95,415596
838	24-06-2021 11:39:45000	1268,3334	399,746552	1329,8372	396,645294	229,003448	1937,6316	50,077324	-95,375092
839	24-06-2021 11:39:50000	1266,5118	393,692535	1326,2904	397,108307	229,270798	1930,2567	50,053486	-95,492805
840	24-06-2021 11:39:55000	1263,6127	401,406647	1325,8372	396,358185	228,837692	1933,2299	50,037106	-95,306778
841	24-06-2021 11:40:00000	1262,288	404,978546	1325,6615	396,843689	229,118011	1930,6155	50,026226	-95,219475
842	24-06-2021 11:40:05000	1259,1288	400,260925	1321,2169	397,000214	229,208374	1923,376	50,031788	-95,30069
843	24-06-2021 11:40:10000	1255,9901	394,239685	1316,4103	396,935394	229,170959	1916,6976	50,055054	-95,410233
844	24-06-2021 11:40:15000	1264,1943	403,42627	1327,0042	396,524017	228,933441	1934,146	50,044788	-95,266792
845	24-06-2021 11:40:20000	1260,0876	393,619659	1320,1354	396,903656	229,152618	1922,2902	50,038979	-95,451401
846	24-06-2021 11:40:25000	1256,0349	402,732544	1319,0212	396,878357	229,138031	1920,7827	50,058285	-95,224762
847	24-06-2021 11:40:30000	1258,423	399,121216	1320,1993	396,89505	229,147659	1922,4075	50,064583	-95,320686
848	24-06-2021 11:40:35000	1265,2998	394,799835	1325,4624	396,808746	229,097839	1930,5043	50,039135	-95,461014
849	24-06-2021 11:40:40000	1258,9834	393,916687	1319,1699	397,153839	229,297073	1919,8433	50,036903	-95,437538
850	24-06-2021 11:40:45000	1263,8947	403,11676	1326,6246	396,87149	229,134064	1931,8552	50,020744	-95,271461
851	24-06-2021 11:40:50000	1257,972	395,105774	1318,5607	396,640747	229,000824	1921,2977	50,025955	-95,404938
852	24-06-2021 11:40:55000	1254,6112	396,015137	1315,6281	396,893188	229,146576	1915,7644	50,037842	-95,362144
853	24-06-2021 11:41:00000	1247,7212	391,626373	1307,7383	397,241425	229,347641	1902,6265	50,078026	-95,410622
854	24-06-2021 11:41:05000	1259,879	400,247955	1321,928	396,702087	229,036255	1926,0076	50,082027	-95,306175
855	24-06-2021 11:41:10000	1267,3009	398,072205	1328,3497	396,671112	229,018372	1935,4625	50,05209	-95,40416
856	24-06-2021 11:41:15000	1256,4629	401,519196	1319,059	397,192108	229,319153	1919,3632	50,059532	-95,254486
857	24-06-2021 11:41:20000	1258,5742	399,09024	1320,334	397,135345	229,286392	1921,4292	50,078876	-95,322403
858	24-06-2021 11:41:25000	1263,4934	394,130402	1323,5386	396,745789	229,061478	1927,9885	50,062767	-95,463287
859	24-06-2021 11:41:30000	1260,2559	401,627075	1322,7052	396,947815	229,178116	1925,8138	50,056591	-95,278664
860	24-06-2021 11:41:35000	1264,7011	401,138885	1326,7936	396,800659	229,09317	1932,4781	50,037193	-95,320107
861	24-06-2021 11:41:40000	1261,9993	398,3638	1323,3804	396,73056	229,052689	1927,812	50,015072	-95,361786
862	24-06-2021 11:41:45000	1260,1608	393,068237	1320,0408	396,78479	229,084	1922,7358	50,001553	-95,463768
863	24-06-2021 11:41:50000	1262,3176	389,170868	1320,9465	396,800079	229,092834	1923,9259	50,003429	-95,5616
864	24-06-2021 11:41:55000	1257,1147	403,192596	1320,1901	396,935883	229,171234	1922,2148	50,013184	-95,22226
865	24-06-2021 11:42:00000	1261,1646	408,345093	1325,6251	396,287079	228,796646	1933,3174	50,008801	-95,137352
866	24-06-2021 11:42:05000	1277,9036	389,65683	1335,9904	394,892181	227,991302	1955,2393	49,927517	-95,652161

867	24-06-2021 11:42:10000	1263,0187	398,022705	1324,2501	396,170837	228,729538	1931,8585	49,908329	-95,376144
868	24-06-2021 11:42:15000	1253,9071	393,654205	1314,2477	396,300751	228,804535	1916,6473	49,924606	-95,408745
869	24-06-2021 11:42:20000	1256,0029	399,224304	1317,924	396,151764	228,718521	1922,7844	49,942978	-95,301628
870	24-06-2021 11:42:25000	1254,5377	406,889313	1318,8722	396,291321	228,799103	1923,5107	49,964275	-95,122009
871	24-06-2021 11:42:30000	1257,7076	393,424652	1317,8055	396,142578	228,713226	1922,6588	49,967518	-95,439545
872	24-06-2021 11:42:35000	1261,3165	402,332367	1323,9301	396,013031	228,638428	1932,3252	49,955738	-95,27063
873	24-06-2021 11:42:40000	1260,9963	394,366425	1321,2253	396,400665	228,862228	1926,4462	49,949074	-95,441422
874	24-06-2021 11:42:45000	1264,4258	394,953491	1324,674	395,918457	228,583832	1933,7393	49,934155	-95,451859
875	24-06-2021 11:42:50000	1263,0078	400,706665	1325,0488	396,179108	228,734314	1933,0726	49,920799	-95,317825
876	24-06-2021 11:42:55000	1263,129	402,666748	1325,7583	396,060303	228,665741	1934,6857	49,909615	-95,275955
877	24-06-2021 11:43:00000	1272,4717	398,574707	1333,434	395,817047	228,525269	1947,1632	49,873203	-95,428177
878	24-06-2021 11:43:05000	1259,3468	404,113312	1322,5966	396,174622	228,73172	1929,6641	49,859531	-95,217751
879	24-06-2021 11:43:10000	1251,2019	392,176025	1311,224	396,331696	228,822418	1912,2769	49,89262	-95,42244
880	24-06-2021 11:43:15000	1252,5396	402,259369	1315,5486	396,282349	228,793915	1918,799	49,928585	-95,210442
881	24-06-2021 11:43:20000	1250,2971	406,484192	1314,7137	396,406372	228,865509	1917,0657	49,963703	-95,100327
882	24-06-2021 11:43:25000	1257,8311	400,186859	1319,9578	395,881226	228,562317	1927,1008	49,972385	-95,293282
883	24-06-2021 11:43:30000	1265,5061	400,740723	1327,4408	395,63205	228,418472	1939,2578	49,946781	-95,334282
884	24-06-2021 11:43:35000	1270,6276	398,726196	1331,7196	395,767334	228,496582	1944,9083	49,897526	-95,412552
885	24-06-2021 11:43:40000	1266,3785	399,456238	1327,8856	395,995056	228,628052	1938,1589	49,871826	-95,36805
886	24-06-2021 11:43:45000	1251,2151	398,807709	1313,2354	396,665741	229,015259	1913,3661	49,897995	-95,277298
887	24-06-2021 11:43:50000	1250,8557	394,380981	1311,5549	396,16275	228,724869	1913,4777	49,929119	-95,371964
888	24-06-2021 11:43:55000	1258,5957	407,29425	1322,8574	395,736206	228,478592	1931,8973	49,938362	-95,142204
889	24-06-2021 11:44:00000	1256,4834	393,001495	1316,5109	396,124481	228,702774	1920,7063	49,961529	-95,440414
890	24-06-2021 11:44:05000	1269,5311	405,44577	1332,7023	395,206848	228,172974	1948,8722	49,940571	-95,259918
891	24-06-2021 11:44:10000	1269,4506	399,171021	1330,73	395,92453	228,587341	1942,6832	49,903503	-95,39505
892	24-06-2021 11:44:15000	1265,8287	398,422089	1327,0503	395,680634	228,446518	1938,4032	49,887638	-95,386642
893	24-06-2021 11:44:20000	1257,3248	393,111603	1317,3468	395,964233	228,610245	1922,8816	49,901058	-95,443726
894	24-06-2021 11:44:25000	1256,5243	402,302216	1319,3561	395,435699	228,305099	1928,296	49,906525	-95,237694
895	24-06-2021 11:44:30000	1257,8301	392,448242	1317,6312	395,451904	228,314453	1925,6796	49,906307	-95,461464
896	24-06-2021 11:44:35000	1251,3636	403,472015	1314,8007	395,412415	228,291656	1921,7175	49,946529	-95,175163

897	24-06-2021 11:44:40000	1263,1079	407,702515	1327,2765	395,125977	228,126282	1941,2499	49,943398	-95,165398
898	24-06-2021 11:44:45000	1266,062	390,946075	1325,0479	395,610687	228,406143	1935,6451	49,907013	-95,548401
899	24-06-2021 11:44:50000	1261,067	402,16629	1323,6418	395,665527	228,43779	1933,4187	49,89053	-95,272522
900	24-06-2021 11:44:55000	1253,2106	395,327576	1314,0854	396,049133	228,659256	1917,5856	49,914341	-95,367508
901	24-06-2021 11:45:00000	1255,7531	398,261932	1317,3944	395,749329	228,48616	1923,8311	49,927414	-95,320953
902	24-06-2021 11:45:05000	1261,5496	393,58905	1321,5217	395,529419	228,359207	1930,9691	49,919052	-95,461884
903	24-06-2021 11:45:10000	1256,8295	401,313324	1319,3456	395,860352	228,550278	1926,1937	49,929646	-95,261581
904	24-06-2021 11:45:15000	1254,6575	397,497864	1316,1193	395,876068	228,559341	1921,3983	49,940361	-95,330078
905	24-06-2021 11:45:20000	1256,4321	397,625549	1317,8496	395,916504	228,582687	1923,7443	49,956547	-95,339561
906	24-06-2021 11:45:25000	1264,4587	397,402557	1325,4376	395,571533	228,38353	1936,4655	49,938435	-95,399345
907	24-06-2021 11:45:30000	1255,6361	398,086365	1317,23	396,042908	228,65567	1922,2469	49,943226	-95,32399
908	24-06-2021 11:45:35000	1260,1356	399,79895	1322,0367	396,135864	228,709335	1928,6505	49,94038	-95,317749
909	24-06-2021 11:45:40000	1263,5132	399,950897	1325,3024	395,673737	228,442535	1935,7006	49,928711	-95,33773
910	24-06-2021 11:45:45000	1266,7074	394,564697	1326,7361	395,460052	228,319168	1938,8674	49,908146	-95,475456
911	24-06-2021 11:45:50000	1263,0287	389,3013	1321,6646	395,864014	228,552383	1929,5151	49,896626	-95,563492
912	24-06-2021 11:45:55000	1246,9111	404,025604	1310,7341	396,293304	228,800232	1911,5806	49,935509	-95,130737
913	24-06-2021 11:46:00000	1254,7214	392,893524	1314,797	395,780029	228,503906	1919,8903	49,961048	-95,430809
914	24-06-2021 11:46:05000	1267,9728	403,683472	1330,6823	394,984589	228,044662	1946,8828	49,929996	-95,287415
915	24-06-2021 11:46:10000	1260,0618	389,036957	1318,7513	395,572449	228,384064	1926,7915	49,917007	-95,549599
916	24-06-2021 11:46:15000	1254,2372	397,611389	1315,7529	395,99353	228,627167	1920,2616	49,941792	-95,324677
917	24-06-2021 11:46:20000	1254,54	404,487305	1318,1353	395,863342	228,552002	1924,3058	49,961056	-95,175362
918	24-06-2021 11:46:25000	1262,1199	396,90213	1323,0563	395,743225	228,482651	1932,1414	49,950134	-95,394272
919	24-06-2021 11:46:30000	1259,7897	393,238007	1319,7371	395,951477	228,60289	1926,3136	49,952213	-95,457619
920	24-06-2021 11:46:35000	1256,1199	401,104858	1318,6062	395,932098	228,591705	1924,6656	49,970055	-95,261185
921	24-06-2021 11:46:40000	1267,8665	395,196869	1328,0309	395,372528	228,268631	1941,1785	49,942959	-95,469658
922	24-06-2021 11:46:45000	1262,6566	394,82663	1322,9474	395,898804	228,572495	1931,267	49,930138	-95,442696
923	24-06-2021 11:46:50000	1262,921	401,954346	1325,3441	395,668732	228,439636	1935,8793	49,918663	-95,290054
924	24-06-2021 11:46:55000	1264,4886	398,006622	1325,6473	395,636414	228,421005	1936,4421	49,898655	-95,386505
925	24-06-2021 11:47:00000	1255,3939	390,722351	1314,792	396,157745	228,72197	1918,1588	49,910767	-95,482323
926	24-06-2021 11:47:05000	1251,9053	408,143768	1316,7567	396,120758	228,700638	1921,1543	49,940948	-95,074913

927	24-06-2021 11:47:10000	1251,7179	394,539307	1312,4248	395,86499	228,552948	1916,0587	49,975048	-95,374443
928	24-06-2021 11:47:15000	1260,6699	395,779022	1321,3363	395,841522	228,539413	1929,1392	49,973213	-95,408707
929	24-06-2021 11:47:20000	1253,6797	395,052612	1314,4503	396,179443	228,734497	1917,5195	49,989182	-95,376732
930	24-06-2021 11:47:25000	1258,2209	393,50592	1318,3198	396,282013	228,793716	1922,6641	50,003944	-95,441261
931	24-06-2021 11:47:30000	1266,7631	402,059723	1329,0375	395,578583	228,387589	1941,7125	49,971321	-95,314323
932	24-06-2021 11:47:35000	1266,8746	396,704468	1327,5338	395,708649	228,462708	1938,87	49,930477	-95,430695
933	24-06-2021 11:47:40000	1259,2616	387,97287	1317,6732	396,169525	228,72879	1922,287	49,937695	-95,567062
934	24-06-2021 11:47:45000	1248,1146	406,252045	1312,5665	396,355469	228,836121	1913,9647	49,968639	-95,08963
935	24-06-2021 11:47:50000	1261,5447	391,176483	1320,8004	395,696198	228,455505	1929,1995	49,969154	-95,513641
936	24-06-2021 11:47:55000	1261,2483	398,490143	1322,7024	395,724976	228,472122	1931,7394	49,970707	-95,353897
937	24-06-2021 11:48:00000	1263,7306	400,125854	1325,5625	395,755829	228,489929	1935,7963	49,958176	-95,335426
938	24-06-2021 11:48:05000	1261,1243	388,871521	1319,718	396,12149	228,70105	1925,5245	49,963207	-95,560135
939	24-06-2021 11:48:10000	1255,2748	409,516724	1320,3857	396,24472	228,772186	1925,887	49,9748	-95,068787
940	24-06-2021 11:48:15000	1254,9929	394,435455	1315,5176	395,96344	228,609787	1920,0947	49,985867	-95,399178
941	24-06-2021 11:48:20000	1269,499	396,564606	1329,9967	395,538055	228,364197	1943,3422	49,956276	-95,451286
942	24-06-2021 11:48:25000	1258,6106	405,677612	1322,3748	396,166443	228,727005	1929,2195	49,955257	-95,178055
943	24-06-2021 11:48:30000	1251,2557	396,908295	1312,6984	396,274597	228,789429	1914,5028	49,992111	-95,319359
944	24-06-2021 11:48:35000	1253,6786	404,078094	1317,1898	396,23877	228,768738	1921,2915	50,017384	-95,178276
945	24-06-2021 11:48:40000	1255,839	392,404236	1315,7175	396,23172	228,764694	1919,0894	50,025978	-95,448982
946	24-06-2021 11:48:45000	1256,9742	391,51413	1316,5361	396,442169	228,8862	1919,2588	50,038731	-95,475861
947	24-06-2021 11:48:50000	1255,8673	400,87088	1318,2944	396,346344	228,830856	1922,3479	50,050976	-95,264557
948	24-06-2021 11:48:55000	1270,9586	395,084259	1330,9498	395,485016	228,333588	1944,9103	50,016178	-95,492607
949	24-06-2021 11:49:00000	1265,2896	398,274506	1326,4917	395,940308	228,596436	1936,174	49,99015	-95,386162
950	24-06-2021 11:49:05000	1259,6661	401,754425	1322,1821	396,14093	228,712265	1928,9291	49,991379	-95,271759
951	24-06-2021 11:49:10000	1253,328	399,998962	1315,6101	396,11731	228,698624	1919,5807	50,011436	-95,265907
952	24-06-2021 11:49:15000	1261,7491	386,209198	1319,5334	395,728027	228,473892	1927,0526	50,017784	-95,620857
953	24-06-2021 11:49:20000	1257,6962	398,230316	1319,2373	395,787018	228,507935	1926,3536	50,017578	-95,335098
954	24-06-2021 11:49:25000	1259,6367	400,92923	1321,9034	396,009094	228,636154	1929,1614	50,027161	-95,289612
955	24-06-2021 11:49:30000	1250,8401	391,755463	1310,7529	396,364899	228,841568	1911,2334	50,05518	-95,429131
956	24-06-2021 11:49:35000	1265,9318	388,135864	1324,0968	396,399109	228,861328	1930,5024	50,047974	-95,607185

957	24-06-2021 11:49:40000	1247,5087	401,135406	1310,4149	396,976349	229,194595	1907,7489	50,092709	-95,199509
958	24-06-2021 11:49:45000	1256,2694	399,851379	1318,3679	396,59024	228,971664	1921,2262	50,110878	-95,289742
959	24-06-2021 11:49:50000	1265,1134	395,456085	1325,4801	396,367828	228,843262	1932,6415	50,097996	-95,445679
960	24-06-2021 11:49:55000	1271,3145	405,70697	1334,4807	396,101471	228,689484	1947,095	50,054974	-95,266609
961	24-06-2021 11:50:00000	1265,9921	388,23526	1324,1836	396,649109	229,005661	1929,4736	50,029297	-95,605469
962	24-06-2021 11:50:05000	1252,6558	393,223785	1312,9247	396,882233	229,140244	1911,8983	50,048008	-95,409561
963	24-06-2021 11:50:10000	1245,941	402,744141	1309,4166	396,96814	229,18985	1906,4777	50,093716	-95,152374
964	24-06-2021 11:50:15000	1259,8547	395,254425	1320,4016	396,232758	228,765289	1925,8269	50,092751	-95,41452
965	24-06-2021 11:50:20000	1270,8551	399,35376	1332,1246	396,210388	228,75238	1943,1443	50,042774	-95,400612
966	24-06-2021 11:50:25000	1262,5995	393,270721	1322,4293	396,586456	228,969498	1927,2618	50,013725	-95,475761
967	24-06-2021 11:50:30000	1256,7292	398,095764	1318,2749	397,02594	229,223236	1919,0459	50,025482	-95,331352
968	24-06-2021 11:50:35000	1265,7534	394,894409	1325,9236	395,874847	228,55864	1935,7457	50,012703	-95,462021
969	24-06-2021 11:50:40000	1272,7365	393,80899	1332,2701	395,541229	228,366028	1946,5485	49,961605	-95,531418
970	24-06-2021 11:50:45000	1266,0759	388,971893	1324,48	396,004974	228,633789	1933,1418	49,933662	-95,590408
971	24-06-2021 11:50:50000	1248,4567	398,999268	1310,6655	396,395294	228,859116	1911,1293	49,959126	-95,253632
972	24-06-2021 11:50:55000	1250,6411	406,536163	1315,057	396,137177	228,710083	1918,6678	49,995609	-95,101669
973	24-06-2021 11:51:00000	1254,9309	395,777283	1315,8613	396,237549	228,768051	1919,4291	50,010723	-95,369537
974	24-06-2021 11:51:05000	1257,2516	393,455414	1317,3795	396,11441	228,69696	1922,2642	50,014908	-95,435791
975	24-06-2021 11:51:10000	1260,3794	398,234314	1321,7969	396,210876	228,752655	1928,246	50,014999	-95,353493
976	24-06-2021 11:51:15000	1267,2548	393,958313	1327,0786	395,864532	228,552689	1937,5549	49,989944	-95,492058
977	24-06-2021 11:51:20000	1267,7817	400,686279	1329,594	395,991211	228,625824	1940,7612	49,952724	-95,351044
978	24-06-2021 11:51:25000	1261,1492	399,052246	1322,7773	396,558289	228,953232	1928,1563	49,928715	-95,341003
979	24-06-2021 11:51:30000	1244,2916	402,821381	1307,871	397,063477	229,244904	1903,9066	49,986881	-95,13871
980	24-06-2021 11:51:35000	1256,87	400,525421	1319,1448	396,325256	228,818695	1923,8318	50,007118	-95,27916
981	24-06-2021 11:51:40000	1265,2072	395,445404	1325,5664	395,937073	228,594574	1935,0573	49,987614	-95,446533
982	24-06-2021 11:51:45000	1253,7235	408,525635	1318,6038	396,555908	228,951859	1921,8788	50,00296	-95,079628
983	24-06-2021 11:51:50000	1252,2983	398,745117	1314,2483	396,758453	229,068787	1914,6587	50,048904	-95,286278
984	24-06-2021 11:51:55000	1255,1484	401,826721	1317,9008	396,371002	228,845108	1921,724	50,056477	-95,238464
985	24-06-2021 11:52:00000	1263,7899	393,119568	1323,521	396,184601	228,737488	1930,8058	50,048069	-95,486954
986	24-06-2021 11:52:05000	1260,6401	407,352997	1324,8207	396,534851	228,939697	1931,0364	50,048565	-95,155525

987	24-06-2021 11:52:10000	1258,9927	403,98761	1322,2211	396,263611	228,783081	1928,5278	50,054581	-95,218018
988	24-06-2021 11:52:15000	1257,9686	393,154724	1317,9741	396,555481	228,951599	1920,9393	50,060551	-95,447144
989	24-06-2021 11:52:20000	1260,3358	400,169495	1322,3397	396,105316	228,691696	1929,4559	50,060631	-95,311058
990	24-06-2021 11:52:25000	1266,53	395,973236	1326,9863	396,057129	228,663879	1936,4812	50,028534	-95,444077
991	24-06-2021 11:52:30000	1253,5974	391,442078	1313,291	396,350098	228,833008	1915,1057	50,03968	-95,454651
992	24-06-2021 11:52:35000	1265,129	394,678589	1325,2632	396,075104	228,674255	1933,902	50,02882	-95,462471
993	24-06-2021 11:52:40000	1262,1038	396,605103	1322,9518	396,258698	228,780258	1929,6093	50,018463	-95,400581
994	24-06-2021 11:52:45000	1255,5028	409,264923	1320,5245	396,290955	228,798859	1926,0253	50,030945	-95,076065
995	24-06-2021 11:52:50000	1262,6455	390,457214	1321,6393	396,007507	228,635239	1928,912	50,008411	-95,536316
996	24-06-2021 11:52:55000	1259,2444	394,190216	1319,5007	396,186432	228,738556	1924,8545	50,010864	-95,433395
997	24-06-2021 11:53:00000	1254,9071	401,564667	1317,5911	396,281647	228,793503	1921,6478	50,021248	-95,242538
998	24-06-2021 11:53:05000	1254,6484	394,983063	1315,3534	396,401978	228,862991	1917,7301	50,030964	-95,384903
999	24-06-2021 11:53:10000	1247,8896	392,065674	1308,0306	396,624786	228,991608	1906,1185	50,068012	-95,402176
1000	24-06-2021 11:53:15000	1249,4247	400,955109	1312,1842	396,463959	228,898773	1912,8512	50,121822	-95,217178
1001	24-06-2021 11:53:20000	1266,1442	403,132446	1328,7726	395,812103	228,522415	1940,1921	50,094929	-95,286743
1002	24-06-2021 11:53:25000	1267,1702	398,885986	1328,4691	395,927643	228,589142	1939,1278	50,055744	-95,385742
1003	24-06-2021 11:53:30000	1261,8743	393,431427	1321,7847	396,144562	228,714371	1928,385	50,042812	-95,467453
1004	24-06-2021 11:53:35000	1256,7692	402,345612	1319,6024	396,491455	228,914642	1923,4858	50,060455	-95,238464
1005	24-06-2021 11:53:40000	1259,7513	399,241882	1321,502	396,345062	228,830124	1926,9386	50,06118	-95,32724
1006	24-06-2021 11:53:45000	1264,0378	396,037781	1324,6273	396,082092	228,678314	1932,7805	50,051151	-95,425919
1007	24-06-2021 11:53:50000	1257,1929	402,174164	1319,9539	396,257233	228,779404	1925,157	50,057674	-95,245216
1008	24-06-2021 11:53:55000	1257,0457	399,939301	1319,1343	396,13147	228,706802	1924,5502	50,061733	-95,293228
1009	24-06-2021 11:54:00000	1265,7122	402,679016	1328,2235	396,045746	228,657318	1938,1868	50,044758	-95,29361
1010	24-06-2021 11:54:05000	1258,6401	395,44574	1319,2999	396,182983	228,736542	1924,6171	50,044571	-95,402122
1011	24-06-2021 11:54:10000	1256,3491	399,509766	1318,3403	396,399445	228,861511	1922,1316	50,065529	-95,297783
1012	24-06-2021 11:54:15000	1258,1709	401,575531	1320,7031	395,998169	228,629837	1927,4845	50,077026	-95,265228
1013	24-06-2021 11:54:20000	1259,9199	399,856964	1321,8488	395,986816	228,623291	1929,1948	50,076374	-95,314995
1014	24-06-2021 11:54:25000	1263,9852	400,207153	1325,8296	396,020569	228,642792	1934,8872	50,060932	-95,335411
1015	24-06-2021 11:54:30000	1259,3264	396,341553	1320,2233	396,266418	228,784729	1925,5626	50,0578	-95,387375
1016	24-06-2021 11:54:35000	1265,632	393,476013	1325,3859	396,081573	228,677994	1933,9662	50,037693	-95,491585

1017	24-06-2021 11:54:40000	1265,9034	395,277832	1326,1809	396,115845	228,697784	1935,0114	50,01511	-95,454803
1018	24-06-2021 11:54:45000	1252,5814	398,933777	1314,5754	396,701324	229,035812	1915,2535	50,032837	-95,284111
1019	24-06-2021 11:54:50000	1245,0787	399,547516	1307,6158	396,980774	229,197144	1903,8197	50,08572	-95,217468
1020	24-06-2021 11:54:55000	1258,6903	387,457397	1316,9755	396,252014	228,776398	1921,007	50,092525	-95,57431
1021	24-06-2021 11:55:00000	1267,6893	397,386719	1328,5151	396,049103	228,659225	1938,8112	50,067368	-95,421524
1022	24-06-2021 11:55:05000	1259,399	406,268555	1323,3065	396,742798	229,059738	1927,8199	50,067818	-95,170624
1023	24-06-2021 11:55:10000	1255,0791	398,90564	1316,9469	396,559723	228,954056	1919,558	50,08448	-95,302177
1024	24-06-2021 11:55:15000	1265,6299	401,795746	1327,8776	396,094116	228,685242	1937,6892	50,053627	-95,312241
1025	24-06-2021 11:55:20000	1261,5049	391,880157	1320,9711	396,463867	228,898712	1925,8491	50,032959	-95,498299
1026	24-06-2021 11:55:25000	1255,8275	394,316315	1316,2781	396,692719	229,030838	1917,9397	50,037441	-95,407455
1027	24-06-2021 11:55:30000	1261,8138	400,901398	1323,9697	396,239655	228,769272	1931,381	50,029385	-95,305328
1028	24-06-2021 11:55:35000	1255,3735	398,801636	1317,196	396,433197	228,881012	1920,4701	50,037422	-95,306503
1029	24-06-2021 11:55:40000	1255,1476	395,419922	1315,9607	396,549042	228,947876	1918,1324	50,053772	-95,378807
1030	24-06-2021 11:55:45000	1252,7692	404,720306	1316,5216	396,58725	228,96994	1918,7437	50,077126	-95,157509
1031	24-06-2021 11:55:50000	1263,1838	395,207458	1323,5642	396,011139	228,637344	1931,771	50,060787	-95,438042
1032	24-06-2021 11:55:55000	1261,1871	397,3974	1322,3152	396,074982	228,674194	1929,5958	50,047115	-95,37719
1033	24-06-2021 11:56:00000	1261,7878	395,286865	1322,2557	396,184174	228,737244	1928,9872	50,03009	-95,42691
1034	24-06-2021 11:56:05000	1259,4679	399,671417	1321,3617	396,303864	228,806335	1927,0803	50,02393	-95,31591
1035	24-06-2021 11:56:10000	1252,9515	396,124023	1314,0782	396,66333	229,01387	1914,8176	50,05159	-95,348312
1036	24-06-2021 11:56:15000	1249,8561	391,965179	1309,8766	396,601746	228,978317	1908,9636	50,085041	-95,417847
1037	24-06-2021 11:56:20000	1260,6079	405,684509	1324,278	396,275452	228,789917	1931,5242	50,085754	-95,192093
1038	24-06-2021 11:56:25000	1254,9778	395,61853	1315,8583	396,524689	228,933823	1918,0178	50,085201	-95,373314
1039	24-06-2021 11:56:30000	1254,6134	395,126068	1315,3628	396,227234	228,762085	1918,7753	50,105347	-95,381546
1040	24-06-2021 11:56:35000	1265,1036	397,507507	1326,0842	396,134155	228,708359	1934,7972	50,083385	-95,401451
1041	24-06-2021 11:56:40000	1266,7225	397,836212	1327,7273	396,096313	228,686508	1937,3823	50,045528	-95,405327
1042	24-06-2021 11:56:45000	1259,536	392,887146	1319,3904	396,509644	228,925156	1923,291	50,022839	-95,463478
1043	24-06-2021 11:56:50000	1256,5136	394,064728	1316,8573	396,418823	228,872711	1920,0641	50,026649	-95,417587
1044	24-06-2021 11:56:55000	1256,782	397,316986	1318,0903	396,432281	228,880493	1921,7295	50,031696	-95,348709
1045	24-06-2021 11:57:00000	1255,6206	402,513031	1318,5598	396,611115	228,983719	1921,5187	50,035545	-95,226677
1046	24-06-2021 11:57:05000	1256,2367	390,648895	1315,575	396,340485	228,827484	1918,5803	50,036892	-95,489563



1047	24-06-2021 11:57:10000	1256,2462	396,260468	1317,2611	396,279663	228,792374	1921,288	50,039352	-95,36805
1048	24-06-2021 11:57:15000	1259,3138	400,57608	1321,4888	396,269348	228,786407	1927,4551	50,028435	-95,29509
1049	24-06-2021 11:57:20000	1260,0123	397,757141	1321,3031	396,087646	228,681519	1928,1145	50,015701	-95,361343
1050	24-06-2021 11:57:25000	1255,5673	393,061127	1315,6542	396,421478	228,874222	1918,2557	50,026333	-95,432915
1051	24-06-2021 11:57:30000	1256,3552	401,891907	1319,0699	396,41806	228,872253	1923,2948	50,038059	-95,245537
1052	24-06-2021 11:57:35000	1252,8613	399,313171	1314,9572	396,650604	229,006516	1916,0935	50,05954	-95,277725
1053	24-06-2021 11:57:40000	1256,671	403,764526	1319,9424	396,650055	229,00621	1923,3281	50,079605	-95,206505
1054	24-06-2021 11:57:45000	1259,6373	393,957703	1319,8064	396,661499	229,012833	1923,149	50,075714	-95,441071
1055	24-06-2021 11:57:50000	1263,3621	409,306946	1328,012	396,565521	228,957413	1935,5764	50,068161	-95,131828
1056	24-06-2021 11:57:55000	1253,7433	399,517487	1315,8596	396,890747	229,145172	1916,2815	50,070042	-95,279411
1057	24-06-2021 11:58:00000	1253,3918	402,124878	1316,3188	396,824341	229,106827	1917,2369	50,090061	-95,219467
1058	24-06-2021 11:58:05000	1256,9938	390,108612	1316,1376	397,132507	229,284775	1915,5272	50,092587	-95,506264
1059	24-06-2021 11:58:10000	1257,4479	400,510071	1319,6907	396,935028	229,170746	1921,6163	50,100422	-95,283531
1060	24-06-2021 11:58:15000	1259,5759	394,386261	1319,8757	396,723206	229,048447	1922,8276	50,085697	-95,431404
1061	24-06-2021 11:58:20000	1269,4307	397,222809	1330,1279	396,492493	228,915253	1939,0032	50,040607	-95,436737
1062	24-06-2021 11:58:25000	1261,152	396,988617	1322,1591	396,806641	229,096619	1925,8258	50,030422	-95,385811
1063	24-06-2021 11:58:30000	1256,978	396,205505	1317,9425	396,71521	229,043823	1920,1847	50,047466	-95,374268
1064	24-06-2021 11:58:35000	1259,7731	403,344086	1322,7678	396,510498	228,925644	1928,1094	50,041691	-95,237656
1065	24-06-2021 11:58:40000	1264,0187	401,121368	1326,1378	396,497467	228,918121	1933,1361	50,018791	-95,315781
1066	24-06-2021 11:58:45000	1251,9938	394,120056	1312,562	397,075745	229,251984	1910,5768	50,034527	-95,385498
1067	24-06-2021 11:58:50000	1245,5852	397,023071	1307,3293	397,292206	229,376953	1901,9746	50,086689	-95,277084
1068	24-06-2021 11:58:55000	1264,6819	398,61264	1326,0138	396,132935	228,707657	1934,6948	50,076687	-95,374725
1069	24-06-2021 11:59:00000	1262,9415	395,783356	1323,5051	396,859039	229,126877	1927,6405	50,04446	-95,424004
1070	24-06-2021 11:59:05000	1253,3461	404,230286	1316,92	396,646545	229,004181	1919,0144	50,055626	-95,172523
1071	24-06-2021 11:59:10000	1268,3921	398,215485	1329,4337	396,323517	228,817688	1938,7356	50,021919	-95,408447
1072	24-06-2021 11:59:15000	1262,0887	391,776001	1321,4977	396,280365	228,792786	1927,4888	50,008636	-95,504417
1073	24-06-2021 11:59:20000	1255,385	405,084137	1319,1228	396,441315	228,885696	1923,236	50,017216	-95,168175
1074	24-06-2021 11:59:25000	1257,7841	396,597992	1318,8292	396,137695	228,710403	1924,1519	50,021358	-95,371254
1075	24-06-2021 11:59:30000	1257,0355	399,294342	1318,9292	396,09671	228,686737	1924,4987	50,029858	-95,307274
1076	24-06-2021 11:59:35000	1250,3419	399,397583	1312,5826	396,187012	228,738861	1914,8381	50,059364	-95,258141

1077	24-06-2021 11:59:40000	1255,2943	393,326691	1315,4731	396,518677	228,930359	1917,3932	50,075787	-95,425308
1078	24-06-2021 11:59:45000	1264,78	397,828217	1325,8717	395,763275	228,494232	1936,2799	50,051495	-95,392334
1079	24-06-2021 11:59:50000	1260,3993	394,746765	1320,7692	396,181427	228,735657	1926,7893	50,045574	-95,429184
1080	24-06-2021 11:59:55000	1264,9899	401,751495	1327,2543	395,861145	228,550751	1937,8778	50,020554	-95,308792
1081	24-06-2021 12:00:00000	1265,1636	392,54953	1324,6636	396,048767	228,659073	1933,1343	49,983566	-95,508278
1082	24-06-2021 12:00:05000	1254,6655	395,29892	1315,4645	396,287933	228,797134	1918,6298	49,992451	-95,378136
1083	24-06-2021 12:00:10000	1250,5681	389,583496	1309,8458	396,236389	228,767395	1910,6989	50,014568	-95,474457
1084	24-06-2021 12:00:15000	1253,677	403,942749	1317,147	396,316772	228,813797	1920,7517	50,03524	-95,181267
1085	24-06-2021 12:00:20000	1259,7012	394,4487	1320,0139	396,720428	229,046844	1923,2057	50,035824	-95,430901
1086	24-06-2021 12:00:25000	1255,8656	389,55954	1314,8973	397,116394	229,275452	1913,7976	50,044807	-95,510544
1087	24-06-2021 12:00:30000	1249,2753	402,789032	1312,6035	397,557861	229,530334	1908,2585	50,076832	-95,175377
1088	24-06-2021 12:00:35000	1263,0359	401,055847	1325,1813	396,314941	228,812744	1932,655	50,06089	-95,310425
1089	24-06-2021 12:00:40000	1270,1863	410,984802	1335,0212	396,888428	229,143845	1944,2137	50,013737	-95,143524
1090	24-06-2021 12:00:45000	1257,3733	395,981903	1318,2524	397,26123	229,359085	1917,9346	50,022396	-95,381836
1091	24-06-2021 12:00:50000	1249,467	394,839203	1310,3687	397,44104	229,462906	1905,6677	50,058952	-95,352333
1092	24-06-2021 12:00:55000	1246,8477	401,27182	1309,8276	397,721008	229,624527	1903,5571	50,111538	-95,191742
1093	24-06-2021 12:01:00000	1259,8768	402,532349	1322,6193	396,764282	229,072159	1926,6659	50,109924	-95,256195
1094	24-06-2021 12:01:05000	1266,8911	398,905853	1328,2089	397,02652	229,223572	1933,5291	50,072834	-95,383423
1095	24-06-2021 12:01:10000	1271,6462	396,401794	1331,998	396,809204	229,098114	1940,1267	50,018089	-95,469086
1096	24-06-2021 12:01:15000	1262,1686	399,387787	1323,8505	397,31189	229,388336	1925,8833	50,00074	-95,340721
1097	24-06-2021 12:01:20000	1258,9464	395,801849	1319,699	397,423737	229,452896	1919,3027	50,004715	-95,396492
1098	24-06-2021 12:01:25000	1250,4392	402,215729	1313,5356	397,02774	229,224274	1912,2574	50,042095	-95,196449
1099	24-06-2021 12:01:30000	1259,0565	401,793243	1321,613	396,870514	229,133484	1924,7333	50,045219	-95,266647
1100	24-06-2021 12:01:35000	1256,2699	390,936523	1315,6919	397,08844	229,259323	1915,062	50,052235	-95,483582
1101	24-06-2021 12:01:40000	1254,047	399,468811	1316,1343	397,377808	229,426392	1914,2965	50,062134	-95,282608
1102	24-06-2021 12:01:45000	1261,2871	392,753235	1321,0223	397,146362	229,29277	1922,5146	50,061966	-95,478096
1103	24-06-2021 12:01:50000	1264,8135	398,154663	1326,0017	396,914612	229,158966	1930,8694	50,038776	-95,385513
1104	24-06-2021 12:01:55000	1269,8495	400,048523	1331,3739	396,506775	228,923508	1940,6643	49,997013	-95,378876
1105	24-06-2021 12:02:00000	1268,7203	393,693787	1328,3998	396,84317	229,117722	1934,7675	49,955715	-95,507416
1106	24-06-2021 12:02:05000	1254,3557	404,293549	1317,9004	397,283264	229,371796	1917,2908	49,966732	-95,178337

1107	24-06-2021 12:02:10000	1253,0581	401,349823	1315,7645	397,208801	229,328812	1914,5286	49,994568	-95,234222
1108	24-06-2021 12:02:15000	1248,7295	390,70285	1308,4243	397,304871	229,384293	1903,3331	50,038586	-95,43766
1109	24-06-2021 12:02:20000	1252,6947	398,116821	1314,4357	397,364777	229,418869	1911,8354	50,071358	-95,302856
1110	24-06-2021 12:02:25000	1259,535	399,338226	1321,325	397,03653	229,229355	1923,4153	50,072422	-95,323647
1111	24-06-2021 12:02:30000	1261,2185	398,039856	1322,5385	397,127563	229,281906	1924,8032	50,059746	-95,363472
1112	24-06-2021 12:02:35000	1265,3265	391,391998	1324,4768	397,071014	229,249283	1927,8406	50,038261	-95,534058
1113	24-06-2021 12:02:40000	1257,4956	400,188995	1319,6388	397,418549	229,449921	1919,1965	50,032715	-95,290901
1114	24-06-2021 12:02:45000	1251,9266	391,269409	1311,6449	397,307343	229,385712	1908,1241	50,047806	-95,447083
1115	24-06-2021 12:02:50000	1260,4114	392,979034	1320,2535	397,00769	229,212708	1922,0044	50,050499	-95,467377
1116	24-06-2021 12:02:55000	1259,7777	389,543304	1318,6295	396,882996	229,140701	1920,3771	50,056175	-95,536896
1117	24-06-2021 12:03:00000	1258,4722	396,93692	1319,5874	396,919464	229,161758	1921,5265	50,052197	-95,368607
1118	24-06-2021 12:03:05000	1265,6962	399,537689	1327,2593	396,856567	229,125458	1932,9172	50,032143	-95,361641
1119	24-06-2021 12:03:10000	1265,3755	394,099121	1325,3261	397,071228	229,24939	1929,1584	50,00647	-95,47654
1120	24-06-2021 12:03:15000	1260,6733	407,316589	1324,8412	397,055603	229,240372	1928,5208	49,990902	-95,156563
1121	24-06-2021 12:03:20000	1255,4401	389,592865	1314,5007	397,378754	229,426941	1911,9971	50,001465	-95,506981
1122	24-06-2021 12:03:25000	1241,5063	402,590118	1305,1501	397,552582	229,527298	1897,4602	50,057808	-95,123642
1123	24-06-2021 12:03:30000	1258,7523	403,943542	1321,9788	396,895416	229,147873	1925,1486	50,064243	-95,217285
1124	24-06-2021 12:03:35000	1261,9055	386,45224	1319,7542	396,843445	229,117874	1922,0703	50,05476	-95,616714
1125	24-06-2021 12:03:40000	1264,288	405,90976	1327,8503	396,897797	229,149261	1933,6938	50,030136	-95,213127
1126	24-06-2021 12:03:45000	1261,322	391,939087	1320,814	397,335388	229,401917	1921,2727	50,013405	-95,495811
1127	24-06-2021 12:03:50000	1248,9695	396,58313	1310,4209	397,681549	229,601761	1904,6335	50,041637	-95,310562
1128	24-06-2021 12:03:55000	1252,224	405,110748	1316,1229	397,048767	229,236404	1915,8617	50,067383	-95,144913
1129	24-06-2021 12:04:00000	1260,047	394,026978	1320,2181	396,904327	229,15303	1922,5321	50,051083	-95,442337
1130	24-06-2021 12:04:05000	1268,4388	396,264099	1328,8953	396,761292	229,07045	1935,7885	50,008091	-95,45063
1131	24-06-2021 12:04:10000	1264,3289	390,663879	1323,3086	397,662323	229,590668	1923,4868	49,984581	-95,543007
1132	24-06-2021 12:04:15000	1240,3779	398,481689	1302,8142	398,221527	229,913513	1890,9783	50,058475	-95,207581
1133	24-06-2021 12:04:20000	1252,5012	399,027832	1314,5276	397,616577	229,56424	1910,8293	50,09972	-95,281479
1134	24-06-2021 12:04:25000	1264,7461	400,101807	1326,5233	397,412537	229,446457	1929,2222	50,076397	-95,342918
1135	24-06-2021 12:04:30000	1257,6487	398,856537	1319,3812	397,715942	229,621613	1917,3859	50,072567	-95,321098
1136	24-06-2021 12:04:35000	1258,6038	399,881927	1320,6018	397,840485	229,693512	1918,6158	50,078732	-95,305321

1137	24-06-2021 12:04:40000	1265,8229	394,593597	1325,9004	397,205475	229,326889	1929,4237	50,053238	-95,468933
1138	24-06-2021 12:04:45000	1263,6791	399,521667	1325,3309	397,158112	229,299545	1928,8557	50,031803	-95,348183
1139	24-06-2021 12:04:50000	1256,8103	390,628082	1316,1163	397,380402	229,427887	1914,3728	50,035725	-95,493858
1140	24-06-2021 12:04:55000	1255,8718	393,802185	1316,1665	397,318054	229,391891	1914,6736	50,045971	-95,418922
1141	24-06-2021 12:05:00000	1253,4169	399,937042	1315,6761	397,52417	229,51088	1912,9955	50,070507	-95,267891
1142	24-06-2021 12:05:05000	1260,3837	401,544647	1322,802	397,062622	229,244415	1925,5543	50,073391	-95,281357
1143	24-06-2021 12:05:10000	1262,9608	393,513702	1322,8466	396,769592	229,075226	1927,1006	50,061153	-95,472961
1144	24-06-2021 12:05:15000	1277,3326	397,610718	1337,7866	396,11496	228,697281	1951,976	49,986824	-95,481049
1145	24-06-2021 12:05:20000	1272,6572	407,186493	1336,2101	396,530457	228,937149	1947,807	49,932331	-95,243797
1146	24-06-2021 12:05:25000	1253,2122	388,57782	1312,0723	397,358154	229,415039	1908,637	49,943279	-95,513962
1147	24-06-2021 12:05:30000	1245,7354	404,609924	1309,796	397,165833	229,304001	1906,3535	49,997234	-95,109108
1148	24-06-2021 12:05:35000	1254,1108	398,444824	1315,8846	396,292145	228,799561	1919,3098	50,017002	-95,305534
1149	24-06-2021 12:05:40000	1255,6859	398,269989	1317,3329	396,849121	229,121124	1918,7441	50,029648	-95,320313
1150	24-06-2021 12:05:45000	1261,2625	392,710388	1320,9861	396,621246	228,989594	1925,0667	50,014088	-95,478851
1151	24-06-2021 12:05:50000	1252,7318	398,260345	1314,5145	397,236084	229,344559	1912,678	50,029282	-95,299965
1152	24-06-2021 12:05:55000	1256,6216	402,154816	1319,4038	396,96225	229,186462	1921,129	50,040707	-95,241623
1153	24-06-2021 12:06:00000	1261,7546	400,261047	1323,7197	396,706421	229,038742	1928,7224	50,024223	-95,318871
1154	24-06-2021 12:06:05000	1267,165	393,404053	1326,8285	396,851105	229,122299	1932,421	49,986683	-95,503296
1155	24-06-2021 12:06:10000	1259,6083	395,983398	1320,3848	396,875763	229,136505	1923,0751	49,986256	-95,397064
1156	24-06-2021 12:06:15000	1258,3643	392,284851	1318,0925	396,731781	229,053391	1920,4728	49,982956	-95,468582
1157	24-06-2021 12:06:20000	1261,9921	395,2323	1322,4344	396,538849	228,942001	1927,8262	49,976139	-95,429474
1158	24-06-2021 12:06:25000	1259,6492	396,678162	1320,6322	396,61441	228,985641	1924,5895	49,966183	-95,382278
1159	24-06-2021 12:06:30000	1252,3319	390,262695	1311,7317	396,759277	229,069275	1911,1035	49,984329	-95,471649
1160	24-06-2021 12:06:35000	1256,7341	397,894257	1318,2188	396,373413	228,846497	1922,3296	49,994553	-95,335785
1161	24-06-2021 12:06:40000	1256,7034	391,466156	1316,2633	396,63858	228,999588	1918,2006	50,001781	-95,475075
1162	24-06-2021 12:06:45000	1254,184	395,71051	1315,129	396,708679	229,040039	1916,3208	50,018616	-95,365852
1163	24-06-2021 12:06:50000	1260,6433	398,176544	1322,0311	396,6315	228,995499	1926,7388	50,021118	-95,35656
1164	24-06-2021 12:06:55000	1260,0001	392,395172	1319,6873	396,669281	229,017303	1923,1038	50,024494	-95,47718
1165	24-06-2021 12:07:00000	1250,3456	397,852081	1312,1167	397,057281	229,241302	1910,3259	50,063049	-95,292252
1166	24-06-2021 12:07:05000	1256,2668	406,787262	1320,4856	396,534698	228,93959	1924,8558	50,072708	-95,136734

1167	24-06-2021 12:07:10000	1266,5215	397,465515	1327,4244	396,581696	228,966736	1934,7888	50,047222	-95,411949
1168	24-06-2021 12:07:15000	1266,0828	394,440857	1326,1029	396,79361	229,089081	1931,8859	50,027771	-95,473938
1169	24-06-2021 12:07:20000	1255,7335	401,34549	1318,3113	397,05545	229,24025	1919,2943	50,034904	-95,253181
1170	24-06-2021 12:07:25000	1262,432	395,984406	1323,079	396,660095	229,012009	1928,0354	50,017883	-95,416214
1171	24-06-2021 12:07:30000	1257,4154	400,741394	1319,73	396,847015	229,119919	1922,3099	50,025723	-95,278236
1172	24-06-2021 12:07:35000	1254,4965	394,677765	1315,1167	396,733124	229,054153	1916,1689	50,044048	-95,390503
1173	24-06-2021 12:07:40000	1254,7549	404,618774	1318,3801	396,560059	228,954224	1921,8709	50,052898	-95,173981
1174	24-06-2021 12:07:45000	1266,7004	405,260681	1329,9497	396,068787	228,670593	1940,9683	50,025143	-95,24424
1175	24-06-2021 12:07:50000	1260,384	392,854706	1320,1904	396,306946	228,808105	1925,6444	50,007454	-95,469864
1176	24-06-2021 12:07:55000	1271,9583	397,965607	1332,762	395,83316	228,534561	1946,3483	49,968288	-95,437767
1177	24-06-2021 12:08:00000	1276,3917	394,043091	1335,8314	395,958954	228,607193	1950,2444	49,889977	-95,550354
1178	24-06-2021 12:08:05000	1250,2349	396,754944	1311,679	396,884735	229,141678	1910,4475	49,916397	-95,315613
1179	24-06-2021 12:08:10000	1238,4707	394,154968	1299,6799	396,855316	229,124695	1893,1537	49,989376	-95,290443
1180	24-06-2021 12:08:15000	1249,8196	396,777924	1311,29	396,318634	228,81485	1912,5586	50,029873	-95,31221
1181	24-06-2021 12:08:20000	1257,8606	396,036926	1318,7335	396,266235	228,784607	1923,6761	50,031033	-95,383972
1182	24-06-2021 12:08:25000	1252,7119	402,645966	1315,8308	396,804626	229,095444	1916,9348	50,045914	-95,20311
1183	24-06-2021 12:08:30000	1259,0325	398,933014	1320,7235	396,328644	228,820633	1926,3245	50,048382	-95,329002
1184	24-06-2021 12:08:35000	1265,7994	394,411255	1325,8237	396,370453	228,844772	1933,5215	50,022491	-95,472679
1185	24-06-2021 12:08:40000	1263,2426	390,969116	1322,361	396,704712	229,03775	1926,8937	50,000622	-95,529327
1186	24-06-2021 12:08:45000	1264,8965	397,872467	1325,9961	396,579742	228,965607	1932,8027	49,985165	-95,392174
1187	24-06-2021 12:08:50000	1256,1885	398,979095	1318,0265	396,740387	229,058334	1920,4951	49,979618	-95,308289
1188	24-06-2021 12:08:55000	1257,4188	393,799377	1317,6418	396,516266	228,928955	1921,0184	49,980061	-95,429482
1189	24-06-2021 12:09:00000	1257,4338	392,61142	1317,3016	396,831421	229,110901	1918,9448	49,989136	-95,455269
1190	24-06-2021 12:09:05000	1258,6348	396,263031	1319,54	396,360199	228,838852	1924,3716	49,979778	-95,384354
1191	24-06-2021 12:09:10000	1258,0291	391,286591	1317,4758	396,498962	228,918976	1920,7429	49,99115	-95,487839
1192	24-06-2021 12:09:15000	1259,2797	393,767761	1319,4083	396,365448	228,841888	1924,1925	49,992756	-95,442757
1193	24-06-2021 12:09:20000	1259,5592	405,524902	1323,2308	396,428101	228,878067	1929,4567	49,984566	-95,188171
1194	24-06-2021 12:09:25000	1262,3986	400,86557	1324,5162	396,221588	228,758835	1932,3002	49,978371	-95,310158
1195	24-06-2021 12:09:30000	1260,2703	394,776917	1320,6552	396,127686	228,704636	1927,2036	49,957832	-95,427658
1196	24-06-2021 12:09:35000	1264,4473	399,740601	1326,1295	396,157501	228,721832	1934,9915	49,934052	-95,348701

1197	24-06-2021 12:09:40000	1254,1952	402,037262	1317,0573	396,624786	228,991608	1919,4711	49,948624	-95,227089
1198	24-06-2021 12:09:45000	1257,1102	399,180542	1318,9661	396,093567	228,684921	1924,7416	49,961189	-95,310287
1199	24-06-2021 12:09:50000	1250,7927	394,193665	1311,4386	396,549286	228,948029	1911,6224	49,991478	-95,375626
1200	24-06-2021 12:09:55000	1248,0966	397,05188	1309,731	396,619476	228,988541	1908,8849	50,039951	-95,294121
1201	24-06-2021 12:10:00000	1260,0792	386,326721	1317,9711	396,336395	228,825104	1922,3709	50,050823	-95,607498
1202	24-06-2021 12:10:05000	1259,092	402,037842	1321,7213	396,625214	228,991852	1926,2319	50,057674	-95,261536
1203	24-06-2021 12:10:10000	1262,0367	393,221832	1321,8774	396,451508	228,891571	1927,2797	50,048443	-95,473045
1204	24-06-2021 12:10:15000	1275,411	390,28476	1333,7899	396,12973	228,705795	1946,3051	49,99715	-95,623085
1205	24-06-2021 12:10:20000	1261,589	399,498138	1323,3312	396,518097	228,930023	1929,1981	49,97364	-95,334335
1206	24-06-2021 12:10:25000	1260,824	396,86499	1321,8088	396,479645	228,907822	1927,0986	49,963203	-95,386246
1207	24-06-2021 12:10:30000	1260,2753	394,738159	1320,6483	396,479919	228,90799	1925,4377	49,964672	-95,428528
1208	24-06-2021 12:10:35000	1254,5186	399,943268	1316,7275	396,489746	228,913635	1919,615	49,974419	-95,275482
1209	24-06-2021 12:10:40000	1259,178	392,657867	1318,9805	396,439514	228,884659	1923,2134	49,972488	-95,466011
1210	24-06-2021 12:10:45000	1252,7078	402,236389	1315,7017	396,512482	228,926773	1918,0577	49,993259	-95,212143
1211	24-06-2021 12:10:50000	1261,5297	402,259979	1324,1112	396,214508	228,75473	1931,7704	49,995434	-95,273705
1212	24-06-2021 12:10:55000	1258,5256	395,857025	1319,314	396,131744	228,70697	1925,0897	49,98896	-95,392426
1213	24-06-2021 12:11:00000	1257,9272	395,721863	1318,7028	396,417053	228,871689	1922,8302	50,001469	-95,391273
1214	24-06-2021 12:11:05000	1253,2708	400,102173	1315,587	396,53772	228,941345	1917,7775	50,021889	-95,263229
1215	24-06-2021 12:11:10000	1250,6931	394,730652	1311,5051	396,738068	229,057022	1910,7184	50,046738	-95,363197
1216	24-06-2021 12:11:15000	1252,3678	397,901123	1314,0587	396,505127	228,922531	1915,6559	50,070217	-95,305313
1217	24-06-2021 12:11:20000	1265,2678	395,828613	1325,7386	396,138672	228,710953	1934,4773	50,052418	-95,438705
1218	24-06-2021 12:11:25000	1265,5761	387,344116	1323,525	396,181915	228,735931	1930,9747	50,023186	-95,621628
1219	24-06-2021 12:11:30000	1259,722	406,125641	1323,5699	396,460693	228,896881	1929,8893	50,013191	-95,176079
1220	24-06-2021 12:11:35000	1255,4219	404,833099	1319,0807	396,52063	228,931473	1922,8202	50,016014	-95,174004
1221	24-06-2021 12:11:40000	1259,329	391,246643	1318,7052	396,28653	228,796326	1923,4377	50,0103	-95,497383
1222	24-06-2021 12:11:45000	1254,6632	390,664459	1314,077	396,930908	229,168365	1913,6207	50,02256	-95,478661
1223	24-06-2021 12:11:50000	1247,1263	405,900543	1311,5179	397,098114	229,264877	1909,1068	50,072422	-95,090302
1224	24-06-2021 12:11:55000	1258,7361	400,448395	1320,8995	396,375366	228,84761	1926,2222	50,076279	-95,293861
1225	24-06-2021 12:12:00000	1266,7584	390,430817	1325,5614	396,31076	228,810303	1933,3154	50,039909	-95,563919
1226	24-06-2021 12:12:05000	1267,609	398,505981	1328,7737	396,36145	228,839569	1937,8102	50,002537	-95,396904

1227	24-06-2021 12:12:10000	1259,1747	397,122772	1320,3132	396,722229	229,047882	1923,756	49,997803	-95,369377
1228	24-06-2021 12:12:15000	1261,4948	394,263031	1321,6703	396,362488	228,840195	1927,3757	49,998154	-95,447006
1229	24-06-2021 12:12:20000	1258,1852	399,024902	1319,9435	396,652008	229,007324	1923,4731	49,99445	-95,321136
1230	24-06-2021 12:12:25000	1251,9908	402,794067	1315,1898	396,749084	229,06337	1916,1564	50,022209	-95,194695
1231	24-06-2021 12:12:30000	1257,2991	396,503052	1318,3383	396,631287	228,995361	1921,2505	50,03442	-95,369995
1232	24-06-2021 12:12:35000	1261,6932	395,332275	1322,1791	396,137085	228,710037	1929,2504	50,018112	-95,425293
1233	24-06-2021 12:12:40000	1263,3508	392,078094	1322,7926	396,272247	228,788086	1929,4366	49,999428	-95,506332
1234	24-06-2021 12:12:45000	1258,7297	393,094727	1318,6826	396,538818	228,941986	1922,1373	49,993523	-95,453575
1235	24-06-2021 12:12:50000	1264,2289	392,280975	1323,6914	396,471802	228,90329	1929,9347	49,983749	-95,50782
1236	24-06-2021 12:12:55000	1257,2266	391,533173	1316,7827	396,709015	229,040253	1918,598	49,999508	-95,477142
1237	24-06-2021 12:13:00000	1251,6527	397,386322	1313,2214	396,969971	229,190903	1912,1987	50,025757	-95,31163
1238	24-06-2021 12:13:05000	1252,0326	397,355499	1313,5741	396,810547	229,098862	1913,4534	50,046844	-95,314957
1239	24-06-2021 12:13:10000	1251,3586	400,966766	1314,0293	396,803711	229,09491	1914,1743	50,065701	-95,230652
1240	24-06-2021 12:13:15000	1260,8936	398,600586	1322,3973	396,426727	228,877258	1928,0833	50,057835	-95,34906
1241	24-06-2021 12:13:20000	1269,5594	393,151703	1329,0408	395,994934	228,627975	1939,6787	50,024673	-95,52449
1242	24-06-2021 12:13:25000	1267,6387	392,569458	1327,0337	395,742065	228,481979	1937,8905	49,988506	-95,524223
1243	24-06-2021 12:13:30000	1264,8186	396,857361	1325,6176	395,72757	228,473602	1935,8685	49,960773	-95,413536
1244	24-06-2021 12:13:35000	1261,1073	395,680725	1321,7242	396,086609	228,680893	1928,4227	49,958466	-95,413803
1245	24-06-2021 12:13:40000	1253,1248	397,814545	1314,7539	396,050842	228,660233	1918,4586	49,982475	-95,312485
1246	24-06-2021 12:13:45000	1251,6787	398,763855	1313,6636	396,173584	228,73111	1916,3325	50,017643	-95,281517
1247	24-06-2021 12:13:50000	1253,3566	390,763855	1312,8591	395,978699	228,618576	1916,1421	50,037159	-95,467712
1248	24-06-2021 12:13:55000	1247,5402	393,472076	1308,1196	396,370178	228,844604	1907,455	50,077873	-95,368973
1249	24-06-2021 12:14:00000	1264,652	398,182007	1325,8558	395,788391	228,508728	1935,8917	50,063744	-95,383827
1250	24-06-2021 12:14:05000	1270,6447	391,995392	1329,7361	395,835754	228,536072	1941,4094	50,022697	-95,556152
1251	24-06-2021 12:14:10000	1256,4425	398,039764	1317,9846	396,082336	228,678436	1923,0544	50,030781	-95,330589
1252	24-06-2021 12:14:15000	1255,9283	401,857422	1318,6528	396,068542	228,670456	1924,046	50,040447	-95,243286
1253	24-06-2021 12:14:20000	1253,8228	395,278137	1314,6544	396,134552	228,708557	1917,8584	50,059528	-95,372803
1254	24-06-2021 12:14:25000	1267,6506	393,626892	1327,3584	395,599823	228,399841	1939,1495	50,041466	-95,501762
1255	24-06-2021 12:14:30000	1258,7291	396,937195	1319,8328	395,952423	228,603409	1926,3823	50,027508	-95,370361
1256	24-06-2021 12:14:35000	1253,8712	397,090851	1315,2468	396,30484	228,806885	1917,9175	50,053413	-95,333527

1257	24-06-2021 12:14:40000	1261,1196	400,726318	1323,2552	395,55191	228,372192	1933,131	50,0574	-95,304337
1258	24-06-2021 12:14:45000	1260,9252	407,106842	1325,0165	395,64682	228,426987	1935,1235	50,049168	-95,162994
1259	24-06-2021 12:14:50000	1262,0945	395,759338	1322,6896	395,712616	228,464966	1931,6073	50,045631	-95,418793
1260	24-06-2021 12:14:55000	1268,8834	396,233643	1329,3105	395,262726	228,205231	1943,2839	50,017944	-95,454262
1261	24-06-2021 12:15:00000	1267,1907	400,911652	1329,0984	395,536591	228,363327	1941,6788	49,985462	-95,342133
1262	24-06-2021 12:15:05000	1257,7006	400,069611	1319,7979	395,812469	228,522614	1926,7437	49,985889	-95,294937
1263	24-06-2021 12:15:10000	1248,3293	405,722595	1312,6069	396,07959	228,676834	1915,0497	50,036755	-95,103058
1264	24-06-2021 12:15:15000	1251,9003	407,210693	1316,4629	395,842163	228,539764	1921,7836	50,071632	-95,095741
1265	24-06-2021 12:15:20000	1258,2686	396,689636	1319,3188	395,746826	228,484726	1926,3441	50,085732	-95,372581
1266	24-06-2021 12:15:25000	1258,9113	407,515442	1323,2257	395,443848	228,309799	1933,521	50,087257	-95,139565
1267	24-06-2021 12:15:30000	1259,5674	395,50946	1320,2037	395,694977	228,454788	1927,8413	50,083378	-95,407051
1268	24-06-2021 12:15:35000	1266,155	404,844696	1329,3036	395,501312	228,342972	1942,0884	50,059395	-95,249504
1269	24-06-2021 12:15:40000	1268,6302	396,469391	1329,1389	395,392303	228,280029	1942,5129	50,019524	-95,447517
1270	24-06-2021 12:15:45000	1260,5895	401,253845	1322,9098	395,633362	228,419205	1932,2583	50,016125	-95,289146
1271	24-06-2021 12:15:50000	1255,3433	398,947906	1317,2115	395,796326	228,51329	1923,1196	50,022579	-95,303093
1272	24-06-2021 12:15:55000	1251,2488	400,110901	1313,6637	396,002655	228,632431	1916,9771	50,047573	-95,248795
1273	24-06-2021 12:16:00000	1256,7629	397,413696	1318,1012	395,856476	228,548019	1924,0988	50,053673	-95,346466
1274	24-06-2021 12:16:05000	1255,7913	395,764038	1316,678	396,193024	228,74234	1920,3998	50,059875	-95,375732
1275	24-06-2021 12:16:10000	1244,6256	401,929138	1307,9144	396,784576	229,083862	1904,8202	50,128773	-95,161095
1276	24-06-2021 12:16:15000	1261,3822	399,159546	1323,032	395,796478	228,513382	1931,7086	50,135838	-95,340271
1277	24-06-2021 12:16:20000	1279,3364	400,635101	1340,6007	394,98172	228,042999	1961,2611	50,043045	-95,430092
1278	24-06-2021 12:16:25000	1270,28	397,2117	1330,9352	395,498749	228,341507	1944,6934	49,982891	-95,442665
1279	24-06-2021 12:16:30000	1258,1927	395,16394	1318,7887	395,781555	228,504776	1925,506	49,979099	-95,405182
1280	24-06-2021 12:16:35000	1252,7872	401,820465	1315,6501	396,099915	228,688583	1919,4315	50,009361	-95,221909
1281	24-06-2021 12:16:40000	1253,0778	397,760376	1314,6927	396,07251	228,672745	1918,0966	50,045528	-95,313347
1282	24-06-2021 12:16:45000	1257,0957	394,544983	1317,5565	395,675476	228,443542	1924,1271	50,066395	-95,411133
1283	24-06-2021 12:16:50000	1252,4095	407,757446	1317,1165	396,047852	228,658508	1921,7771	50,085999	-95,087227
1284	24-06-2021 12:16:55000	1270,0365	394,005951	1329,7495	395,396698	228,282578	1943,4751	50,054276	-95,509468
1285	24-06-2021 12:17:00000	1260,823	401,38266	1323,1715	395,85907	228,54953	1931,4835	50,04002	-95,287956
1286	24-06-2021 12:17:05000	1255,1493	395,643768	1316,0295	396,123932	228,702438	1919,8593	50,058174	-95,373947



1287	24-06-2021 12:17:10000	1252,1061	396,981934	1313,5314	396,230316	228,763855	1915,7296	50,086521	-95,323662
1288	24-06-2021 12:17:15000	1261,3033	410,00589	1326,2694	395,589844	228,394073	1937,3599	50,08099	-95,101585
1289	24-06-2021 12:17:20000	1264,847	398,352417	1326,0929	395,768463	228,497208	1936,3112	50,05294	-95,38147
1290	24-06-2021 12:17:25000	1261,8319	400,147552	1323,7588	395,864746	228,552795	1932,4159	50,040852	-95,321877
1291	24-06-2021 12:17:30000	1255,1454	396,038055	1316,1444	395,950226	228,602158	1920,9423	50,055588	-95,365326
1292	24-06-2021 12:17:35000	1255,9562	391,875275	1315,6716	396,418274	228,872391	1917,8922	50,071728	-95,461212
1293	24-06-2021 12:17:40000	1256,5222	405,644135	1320,377	395,995544	228,628326	1926,7388	50,098473	-95,163902
1294	24-06-2021 12:17:45000	1266,6448	399,241455	1328,075	395,915558	228,582153	1938,3149	50,073643	-95,374504
1295	24-06-2021 12:17:50000	1257,9392	394,936035	1318,4785	396,326721	228,819534	1922,3833	50,080013	-95,408401
1296	24-06-2021 12:17:55000	1247,426	404,308136	1311,311	396,708832	229,040146	1910,0903	50,118813	-95,128151
1297	24-06-2021 12:18:00000	1261,7893	400,079346	1323,6978	396,0466	228,657791	1931,4292	50,117558	-95,323067
1298	24-06-2021 12:18:05000	1268,6846	398,73941	1329,8699	395,963989	228,610107	1940,9598	50,089973	-95,399155
1299	24-06-2021 12:18:10000	1260,3385	397,79776	1321,6263	396,145782	228,715042	1927,9882	50,076599	-95,362694
1300	24-06-2021 12:18:15000	1261,5037	404,215179	1324,6816	396,15213	228,718704	1932,3556	50,062206	-95,230705
1301	24-06-2021 12:18:20000	1257,8824	390,847931	1317,2054	396,43866	228,88414	1920,139	50,07568	-95,496292
1302	24-06-2021 12:18:25000	1254,5808	399,272858	1316,5834	396,392914	228,857742	1919,4976	50,097271	-95,290642
1303	24-06-2021 12:18:30000	1265,3887	400,473541	1327,2482	395,894958	228,570236	1937,3737	50,078716	-95,339272
1304	24-06-2021 12:18:35000	1264,9342	398,140076	1326,1123	395,94754	228,600616	1935,4938	50,053387	-95,38665
1305	24-06-2021 12:18:40000	1260,0946	392,476959	1319,8018	396,571228	228,960693	1923,3169	50,05962	-95,476051
1306	24-06-2021 12:18:45000	1247,7373	401,3172	1310,6884	396,803711	229,09491	1908,8479	50,10466	-95,197105
1307	24-06-2021 12:18:50000	1252,5754	400,699463	1315,1066	396,426758	228,877274	1917,1315	50,128201	-95,245171
1308	24-06-2021 12:18:55000	1270,792	394,053192	1330,4849	395,497833	228,340973	1943,9961	50,089539	-95,513443
1309	24-06-2021 12:19:00000	1269,0964	393,807495	1328,7927	395,855621	228,547531	1939,7992	50,055923	-95,507477
1310	24-06-2021 12:19:05000	1256,4819	404,421539	1319,9635	396,294128	228,800705	1924,8	50,059689	-95,190659
1311	24-06-2021 12:19:10000	1260,8384	392,233765	1320,4396	396,059113	228,665024	1926,6296	50,060684	-95,486259
1312	24-06-2021 12:19:15000	1249,9908	407,563629	1314,7566	396,240326	228,769623	1917,3921	50,090763	-95,073929
1313	24-06-2021 12:19:20000	1257,6777	397,949005	1319,1349	396,382721	228,851852	1923,1229	50,102703	-95,341103
1314	24-06-2021 12:19:25000	1250,1359	395,044861	1311,0682	396,532379	228,938263	1910,6041	50,140404	-95,352455
1315	24-06-2021 12:19:30000	1267,1842	402,684296	1329,6279	395,923981	228,58699	1940,5588	50,122635	-95,303665
1316	24-06-2021 12:19:35000	1259,8785	398,181824	1321,3035	396,292358	228,799683	1926,7596	50,112888	-95,351189

1317	24-06-2021 12:19:40000	1257,7327	397,390228	1319,0188	396,435272	228,882187	1922,7377	50,116455	-95,353661
1318	24-06-2021 12:19:45000	1262,1563	398,236511	1323,4919	396,26535	228,784103	1930,0692	50,101807	-95,365623
1319	24-06-2021 12:19:50000	1264,9578	395,784668	1325,4296	396,115784	228,697739	1933,566	50,084091	-95,437569
1320	24-06-2021 12:19:55000	1263,7145	396,483856	1324,4521	396,14325	228,713593	1932,0721	50,063473	-95,414124
1321	24-06-2021 12:20:00000	1269,3789	398,405945	1330,4323	395,998901	228,630249	1941,6093	50,033108	-95,411011
1322	24-06-2021 12:20:05000	1260,0693	400,079315	1322,0582	396,421906	228,874481	1927,2963	50,031033	-95,31118
1323	24-06-2021 12:20:10000	1254,241	400,768463	1316,714	396,495178	228,916794	1919,0554	50,051872	-95,255386
1324	24-06-2021 12:20:15000	1254,1919	397,400299	1315,646	396,306946	228,808105	1918,402	50,077312	-95,328979
1325	24-06-2021 12:20:20000	1258,366	395,335632	1319,0054	395,981262	228,620071	1924,9009	50,092209	-95,402641
1326	24-06-2021 12:20:25000	1257,0383	398,578369	1318,7155	396,129364	228,705582	1923,6626	50,103191	-95,322952
1327	24-06-2021 12:20:30000	1263,0951	403,584991	1326,0052	396,059692	228,665344	1934,7576	50,092751	-95,255661
1328	24-06-2021 12:20:35000	1261,9739	401,941956	1324,4377	395,869324	228,555435	1933,3864	50,075092	-95,283745
1329	24-06-2021 12:20:40000	1261,9277	394,109589	1322,0377	396,393372	228,858017	1927,2679	50,068363	-95,453224
1330	24-06-2021 12:20:45000	1252,5887	399,422913	1314,7308	396,461914	228,897568	1916,2472	50,090771	-95,273399
1331	24-06-2021 12:20:50000	1257,986	402,776703	1320,8928	396,327271	228,819839	1925,9094	50,095222	-95,237556
1332	24-06-2021 12:20:55000	1264,4147	394,682343	1324,5824	395,932404	228,591873	1933,1626	50,078354	-95,457603
1333	24-06-2021 12:21:00000	1256,2437	402,718842	1319,2159	396,345001	228,830063	1923,3729	50,092819	-95,22654
1334	24-06-2021 12:21:05000	1265,4163	402,523132	1327,8943	395,998779	228,630203	1937,7303	50,079861	-95,29496
1335	24-06-2021 12:21:10000	1261,5575	405,318237	1325,0699	396,035461	228,651352	1933,488	50,074749	-95,206863
1336	24-06-2021 12:21:15000	1255,1857	396,211517	1316,2349	396,246643	228,7733	1919,6588	50,079697	-95,361816
1337	24-06-2021 12:21:20000	1258,6945	400,049683	1320,7391	396,374268	228,846985	1925,7053	50,085358	-95,302284
1338	24-06-2021 12:21:25000	1257,8763	402,015289	1320,5564	396,277039	228,790848	1925,7002	50,085556	-95,25351
1339	24-06-2021 12:21:30000	1258,2891	399,876617	1320,3003	396,267853	228,785538	1925,5198	50,076336	-95,303253
1340	24-06-2021 12:21:35000	1255,0945	394,473541	1315,6259	396,404694	228,864548	1918,0582	50,08984	-95,39904
1341	24-06-2021 12:21:40000	1251,1542	396,915222	1312,6036	396,402863	228,86348	1913,5542	50,12299	-95,318504
1342	24-06-2021 12:21:45000	1265,1063	408,283295	1329,3566	396,206207	228,749954	1938,8745	50,120705	-95,166809
1343	24-06-2021 12:21:50000	1268,3777	398,231201	1329,4248	395,981903	228,620453	1940,1316	50,092537	-95,408012
1344	24-06-2021 12:21:55000	1260,5782	406,766266	1324,5815	396,15451	228,720108	1932,1023	50,079517	-95,168037
1345	24-06-2021 12:22:00000	1255,3793	400,703644	1317,7787	396,218689	228,757141	1922,0016	50,09621	-95,264809
1346	24-06-2021 12:22:05000	1271,0117	401,312866	1332,8627	395,312012	228,233688	1948,3956	50,06282	-95,359543

1347	24-06-2021 12:22:10000	1266,677	392,021393	1325,953	395,475891	228,328308	1937,488	50,027622	-95,529556
1348	24-06-2021 12:22:15000	1253,517	397,962555	1315,1726	395,955444	228,605164	1919,5045	50,038841	-95,311974
1349	24-06-2021 12:22:20000	1248,3857	405,887787	1312,7117	395,862915	228,551727	1916,3103	50,073345	-95,09977
1350	24-06-2021 12:22:25000	1256,556	390,787445	1315,9209	395,720398	228,469467	1921,5588	50,089275	-95,488716
1351	24-06-2021 12:22:30000	1252,3761	396,792511	1313,7313	395,833466	228,534744	1917,8162	50,113491	-95,329689
1352	24-06-2021 12:22:35000	1265,4652	399,747803	1327,1022	395,594635	228,396866	1938,5136	50,088516	-95,355515
1353	24-06-2021 12:22:40000	1259,2667	396,237122	1320,135	396,010193	228,63678	1926,4598	50,081619	-95,389236
1354	24-06-2021 12:22:45000	1253,2317	403,283447	1316,521	395,846466	228,542252	1921,9105	50,097988	-95,192696
1355	24-06-2021 12:22:50000	1256,4817	396,002502	1317,4081	395,795563	228,512848	1923,3826	50,107079	-95,375275
1356	24-06-2021 12:22:55000	1265,7068	401,32312	1327,808	395,281281	228,215942	1941,1244	50,078442	-95,323029
1357	24-06-2021 12:23:00000	1259,1677	401,479309	1321,6237	395,797058	228,513733	1929,6089	50,056683	-95,274307
1358	24-06-2021 12:23:05000	1255,6234	400,30722	1317,8907	395,865509	228,553268	1923,7632	50,064259	-95,27523
1359	24-06-2021 12:23:10000	1255,6887	402,666046	1318,6714	395,820923	228,527512	1925,0701	50,075989	-95,223778
1360	24-06-2021 12:23:15000	1258,6334	398,76535	1320,2924	395,735046	228,477921	1927,9438	50,080948	-95,329903
1361	24-06-2021 12:23:20000	1256,8751	400,438751	1319,1233	395,812561	228,522675	1925,8303	50,092789	-95,281097
1362	24-06-2021 12:23:25000	1261,1251	410,977539	1326,4008	397,41748	229,44928	1928,6448	50,090168	-95,078735
1363	24-06-2021 12:23:30000	1264,0599	393,597931	1323,921	397,71344	229,620148	1923,7036	50,076584	-95,4785
1364	24-06-2021 12:23:35000	1258,0221	406,976593	1322,2139	397,726013	229,627426	1921,0792	50,084579	-95,145126
1365	24-06-2021 12:23:40000	1256,035	398,327057	1317,683	397,757477	229,645584	1914,3533	50,098736	-95,321487
1366	24-06-2021 12:23:45000	1262,4061	399,487457	1324,1071	397,473328	229,481537	1925,1531	50,095531	-95,340187
1367	24-06-2021 12:23:50000	1261,9393	392,396545	1321,5393	397,184418	229,314713	1922,7933	50,085178	-95,490112
1368	24-06-2021 12:23:55000	1269,2727	398,733337	1330,429	397,166199	229,304214	1935,7218	50,049557	-95,403259
1369	24-06-2021 12:24:00000	1257,8433	402,606873	1320,7051	397,668854	229,594406	1919,2733	50,035122	-95,24028
1370	24-06-2021 12:24:05000	1259,8534	393,30014	1319,8164	397,355621	229,413574	1919,4135	50,041111	-95,456711
1371	24-06-2021 12:24:10000	1253,462	400,936737	1316,0233	397,715424	229,621307	1912,118	50,056171	-95,246185
1372	24-06-2021 12:24:15000	1256,3546	399,204163	1318,2528	397,446381	229,465988	1916,7003	50,080856	-95,30452
1373	24-06-2021 12:24:20000	1261,4956	400,041931	1323,4065	397,114594	229,274414	1925,7268	50,078415	-95,321854
1374	24-06-2021 12:24:25000	1255,0825	398,976654	1316,9718	397,547394	229,524307	1914,342	50,081829	-95,300644
1375	24-06-2021 12:24:30000	1256,6581	393,552979	1316,8423	397,466766	229,477753	1914,5614	50,094086	-95,429665
1376	24-06-2021 12:24:35000	1259,1987	399,468872	1321,0439	397,366486	229,41983	1921,1169	50,101151	-95,318466

1377	24-06-2021 12:24:40000	1265,8801	397,027161	1326,6813	397,247253	229,351013	1929,9171	50,082977	-95,417053
1378	24-06-2021 12:24:45000	1267,0592	392,730011	1326,5278	397,302216	229,382751	1929,4918	50,045876	-95,516975
1379	24-06-2021 12:24:50000	1261,632	397,333527	1322,7205	397,402771	229,440796	1923,4899	50,043983	-95,381607
1380	24-06-2021 12:24:55000	1247,1388	403,863586	1310,9009	397,905731	229,731171	1903,8015	50,084255	-95,136017
1381	24-06-2021 12:25:00000	1249,6584	403,876465	1313,3021	397,698914	229,611755	1908,2659	50,12587	-95,153923
1382	24-06-2021 12:25:05000	1263,4622	399,238586	1325,0388	397,064545	229,245514	1928,4757	50,114037	-95,352837
1383	24-06-2021 12:25:10000	1262,0714	393,26001	1321,9219	397,425964	229,454193	1922,198	50,09893	-95,472458
1384	24-06-2021 12:25:15000	1264,0342	404,302582	1327,1184	397,340485	229,404816	1930,1438	50,085419	-95,246536
1385	24-06-2021 12:25:20000	1260,382	397,53244	1321,588	397,632996	229,573715	1920,7753	50,078686	-95,368752
1386	24-06-2021 12:25:25000	1257,9528	385,549133	1315,7102	398,059143	229,819748	1910,1183	50,093071	-95,610168
1387	24-06-2021 12:25:30000	1255,3424	401,026794	1317,8418	397,815918	229,679321	1914,3303	50,107826	-95,257439
1388	24-06-2021 12:25:35000	1253,2948	393,24176	1313,5399	397,905701	229,731155	1907,7432	50,127323	-95,413536
1389	24-06-2021 12:25:40000	1262,4099	396,049011	1323,0773	397,196503	229,321701	1924,8905	50,117813	-95,414673
1390	24-06-2021 12:25:45000	1271,3988	401,470428	1333,2793	397,368774	229,421173	1938,924	50,065273	-95,35878
1391	24-06-2021 12:25:50000	1265,3031	403,193451	1327,9897	397,905487	229,731033	1928,6396	50,038372	-95,279579
1392	24-06-2021 12:25:55000	1262,1422	389,7854	1320,9601	397,733337	229,631653	1919,3486	50,027992	-95,54734
1393	24-06-2021 12:26:00000	1253,5311	390,670135	1312,9979	397,96109	229,763153	1906,6836	50,041931	-95,470917
1394	24-06-2021 12:26:05000	1250,6348	405,217987	1314,6442	397,871063	229,711166	1909,4783	50,080444	-95,131058
1395	24-06-2021 12:26:10000	1260,6536	395,038208	1321,0989	397,47998	229,485367	1920,728	50,08889	-95,424606
1396	24-06-2021 12:26:15000	1256,5084	403,153015	1319,6006	397,678162	229,599792	1917,6891	50,090714	-95,218842
1397	24-06-2021 12:26:20000	1254,8644	393,283173	1315,0499	398,104126	229,845718	1908,9503	50,107224	-95,423325
1398	24-06-2021 12:26:25000	1260,1029	400,974548	1322,3616	397,680542	229,601151	1921,6035	50,106491	-95,291862
1399	24-06-2021 12:26:30000	1263,8867	390,071045	1322,7113	397,876984	229,714569	1921,1764	50,08168	-95,552734
1400	24-06-2021 12:26:35000	1251,5779	398,926239	1313,6169	398,324768	229,973114	1905,8243	50,112968	-95,277237
1401	24-06-2021 12:26:40000	1257,2411	401,592682	1319,8226	398,121338	229,855652	1915,8542	50,125477	-95,258331
1402	24-06-2021 12:26:45000	1266,8904	398,653687	1328,1324	397,69754	229,610977	1929,9426	50,105976	-95,388855
1403	24-06-2021 12:26:50000	1267,4948	394,207428	1327,3817	397,92627	229,743027	1927,817	50,075348	-95,488335
1404	24-06-2021 12:26:55000	1264,5889	391,464172	1323,7935	398,120117	229,85495	1921,6555	50,054207	-95,527657
1405	24-06-2021 12:27:00000	1253,7068	399,195313	1315,7271	397,990967	229,78038	1910,5526	50,07373	-95,28624
1406	24-06-2021 12:27:05000	1255,6775	394,395447	1316,1587	397,879089	229,71579	1911,663	50,086544	-95,404716

1407	24-06-2021 12:27:10000	1260,9353	400,198547	1322,9198	398,000458	229,785858	1920,9099	50,074051	-95,314568
1408	24-06-2021 12:27:15000	1261,0853	395,576447	1321,672	397,729401	229,629364	1920,3673	50,07151	-95,415909
1409	24-06-2021 12:27:20000	1261,4557	394,975464	1321,8457	398,060303	229,820419	1919,0905	50,064659	-95,431389
1410	24-06-2021 12:27:25000	1257,0183	397,017151	1318,2252	397,966278	229,766144	1914,4099	50,062424	-95,356873
1411	24-06-2021 12:27:30000	1257,3206	395,465698	1318,0471	398,167511	229,882309	1913,1421	50,072849	-95,392693
1412	24-06-2021 12:27:35000	1261,3496	390,787964	1320,4991	397,747559	229,639847	1918,6261	50,070873	-95,520668
1413	24-06-2021 12:27:40000	1259,5507	390,254578	1318,6229	397,95575	229,76004	1914,913	50,08197	-95,520149
1414	24-06-2021 12:27:45000	1260,6322	398,718933	1322,1838	397,842194	229,694489	1920,5599	50,073528	-95,344696
1415	24-06-2021 12:27:50000	1262,1128	401,747009	1324,5111	397,679291	229,600433	1924,8398	50,063499	-95,288963
1416	24-06-2021 12:27:55000	1262,5002	395,206024	1322,9115	397,983398	229,776016	1921,0587	50,061256	-95,433464
1417	24-06-2021 12:28:00000	1255,5651	391,699249	1315,246	398,164581	229,88063	1908,9613	50,069324	-95,462379
1418	24-06-2021 12:28:05000	1256,9519	390,065063	1316,0847	397,866211	229,708359	1911,6052	50,077248	-95,50692
1419	24-06-2021 12:28:10000	1263,3204	401,125519	1325,4735	397,686768	229,604767	1926,0691	50,072826	-95,310875
1420	24-06-2021 12:28:15000	1263,537	394,767456	1323,7701	397,620514	229,566513	1923,9001	50,058079	-95,44989
1421	24-06-2021 12:28:20000	1255,3352	398,433136	1317,048	397,96521	229,765518	1912,5215	50,075333	-95,314308
1422	24-06-2021 12:28:25000	1266,7488	406,231079	1330,2917	397,456787	229,47197	1934,2186	50,049454	-95,223381
1423	24-06-2021 12:28:30000	1270,4056	396,324036	1330,7904	397,147522	229,293427	1936,4309	50,018257	-95,462486
1424	24-06-2021 12:28:35000	1260,1626	390,000824	1319,1324	397,49527	229,494186	1917,8369	50,003681	-95,529648
1425	24-06-2021 12:28:40000	1254,916	394,893127	1315,5817	398,042877	229,810349	1910,0216	50,038616	-95,388695
1426	24-06-2021 12:28:45000	1257,7965	404,518707	1321,2445	397,59198	229,550034	1920,2994	50,054428	-95,197853
1427	24-06-2021 12:28:50000	1265,0908	396,344849	1325,724	397,401306	229,439957	1927,7742	50,042057	-95,426414
1428	24-06-2021 12:28:55000	1245,3281	399,514648	1307,8434	398,835754	230,268127	1895,0201	50,08625	-95,219978
1429	24-06-2021 12:29:00000	1261,4606	402,683167	1324,174	397,809021	229,675323	1923,6122	50,104046	-95,263969
1430	24-06-2021 12:29:05000	1256,9541	398,985077	1318,7581	398,245667	229,927444	1913,6639	50,112228	-95,313477
1431	24-06-2021 12:29:10000	1260,0822	399,190277	1321,8018	397,950989	229,757309	1919,55	50,107788	-95,330643
1432	24-06-2021 12:29:15000	1265,5989	394,624359	1325,6956	397,965759	229,765823	1925,0912	50,087387	-95,466774
1433	24-06-2021 12:29:20000	1260,5455	402,454102	1323,2325	398,192902	229,896973	1920,488	50,075699	-95,262589
1434	24-06-2021 12:29:25000	1260,9518	396,089691	1321,6984	398,086914	229,835785	1918,6704	50,070675	-95,4039
1435	24-06-2021 12:29:30000	1257,1187	394,089508	1317,442	398,232239	229,919662	1911,9529	50,093056	-95,421165
1436	24-06-2021 12:29:35000	1259,948	395,892883	1320,6816	398,053711	229,816605	1917,4868	50,094242	-95,401337

1437	24-06-2021 12:29:40000	1258,6414	392,069214	1318,293	398,364685	229,99614	1912,4766	50,097767	-95,47509
1438	24-06-2021 12:29:45000	1257,606	399,899567	1319,6563	398,148285	229,871201	1915,5533	50,106407	-95,298004
1439	24-06-2021 12:29:50000	1272,2347	395,272583	1332,2244	397,621826	229,567245	1936,3323	50,061947	-95,497032
1440	24-06-2021 12:29:55000	1265,6628	390,692505	1324,5917	397,981445	229,774872	1923,5221	50,031776	-95,55117
1441	24-06-2021 12:30:00000	1255,6372	396,727295	1316,8209	398,194427	229,897858	1911,2319	50,04089	-95,353676
1442	24-06-2021 12:30:05000	1262,2654	404,875549	1325,6086	397,739502	229,635208	1926,1198	50,036098	-95,221573
1443	24-06-2021 12:30:10000	1264,1638	398,66394	1325,5352	397,711395	229,618973	1926,0488	50,018955	-95,370079
1444	24-06-2021 12:30:15000	1256,2207	402,730438	1319,1976	397,786469	229,662308	1916,6545	50,028984	-95,22612
1445	24-06-2021 12:30:20000	1258,1051	396,499908	1319,1061	397,682739	229,602417	1916,9625	50,031853	-95,375587
1446	24-06-2021 12:30:25000	1258,0873	389,076202	1316,8766	397,960663	229,762894	1912,3945	50,040241	-95,535706
1447	24-06-2021 12:30:30000	1256,168	405,610199	1320,0294	397,752716	229,642822	1917,9546	50,056873	-95,162117
1448	24-06-2021 12:30:35000	1262,4612	392,092896	1321,9475	397,690216	229,60675	1921,0792	50,050182	-95,500099
1449	24-06-2021 12:30:40000	1257,5518	395,3479	1318,2323	397,695343	229,609711	1915,6345	50,045578	-95,396828
1450	24-06-2021 12:30:45000	1255,1781	400,698212	1317,5853	398,402435	230,017929	1911,3586	50,068802	-95,263512
1451	24-06-2021 12:30:50000	1260,9515	407,549957	1325,1776	397,710693	229,618561	1925,6157	50,068474	-95,153397
1452	24-06-2021 12:30:55000	1265,678	399,593567	1327,2587	397,552155	229,527039	1929,4382	50,045097	-95,360306
1453	24-06-2021 12:31:00000	1261,9166	399,006165	1323,4951	397,858917	229,704132	1922,4185	50,025421	-95,347275
1454	24-06-2021 12:31:05000	1248,8577	399,893616	1311,3201	397,995605	229,783051	1904,2144	50,043526	-95,236679
1455	24-06-2021 12:31:10000	1255,4249	394,984222	1316,0944	397,742981	229,637207	1912,3376	50,063446	-95,39019
1456	24-06-2021 12:31:15000	1266,6847	394,769867	1326,7756	397,449738	229,467911	1929,1447	50,040077	-95,470909
1457	24-06-2021 12:31:20000	1260,3398	398,47171	1321,8306	397,678284	229,599869	1920,9906	50,027977	-95,348061
1458	24-06-2021 12:31:25000	1261,0071	401,646698	1323,4271	397,454742	229,470795	1924,3104	50,028728	-95,28347
1459	24-06-2021 12:31:30000	1258,1575	398,4888	1319,7551	397,720123	229,624023	1917,6437	50,033878	-95,332649
1460	24-06-2021 12:31:35000	1258,5281	401,30835	1320,9623	397,670532	229,595383	1919,6514	50,037704	-95,273582
1461	24-06-2021 12:31:40000	1265,7587	395,420959	1326,0854	397,352142	229,41156	1928,7136	50,018913	-95,45076
1462	24-06-2021 12:31:45000	1257,2686	395,274567	1317,9401	397,641998	229,578918	1915,4299	50,02034	-95,396484
1463	24-06-2021 12:31:50000	1260,1227	398,048553	1321,4961	397,540466	229,520294	1921,0828	50,021973	-95,355766
1464	24-06-2021 12:31:55000	1253,7692	401,858582	1316,5969	397,945587	229,754181	1912,0269	50,041431	-95,22802
1465	24-06-2021 12:32:00000	1255,7325	398,952881	1317,5841	397,810944	229,676453	1914,2062	50,056938	-95,305695
1466	24-06-2021 12:32:05000	1256,5375	398,999268	1318,3652	397,873932	229,712814	1914,9789	50,071396	-95,310272

1467	24-06-2021 12:32:10000	1256,8982	397,157135	1318,1528	398,11319	229,850952	1913,5311	50,083538	-95,352997
1468	24-06-2021 12:32:15000	1258,4003	395,286194	1319,0233	397,879486	229,716019	1915,9348	50,08202	-95,403946
1469	24-06-2021 12:32:20000	1264,7069	402,1633	1327,1091	397,878998	229,715744	1927,6768	50,062874	-95,297874
1470	24-06-2021 12:32:25000	1270,6987	399,461426	1332,0078	397,740417	229,635742	1935,498	50,022896	-95,397247
1471	24-06-2021 12:32:30000	1254,5043	397,016479	1315,8279	398,308014	229,963425	1909,2271	50,036186	-95,339539
1472	24-06-2021 12:32:35000	1254,9375	394,432678	1315,4639	397,864044	229,707108	1910,8673	50,048374	-95,398857
1473	24-06-2021 12:32:40000	1256,6802	396,670715	1317,7985	397,865906	229,708176	1914,2483	50,055077	-95,362091
1474	24-06-2021 12:32:45000	1262,5807	404,000763	1325,642	397,792725	229,665939	1925,8572	50,046417	-95,242966
1475	24-06-2021 12:32:50000	1261,4397	394,6008	1321,7184	397,829132	229,686966	1920,1198	50,037979	-95,439362
1476	24-06-2021 12:32:55000	1267,4634	394,529114	1327,4474	397,366119	229,419647	1930,5702	50,009743	-95,481247
1477	24-06-2021 12:33:00000	1264,9916	399,139252	1326,4675	397,645081	229,580688	1927,876	49,99913	-95,365448
1478	24-06-2021 12:33:05000	1254,3999	403,240295	1317,6199	397,884399	229,718857	1913,9465	50,017036	-95,201965
1479	24-06-2021 12:33:10000	1257,7068	400,925629	1320,0635	397,829102	229,686935	1917,667	50,037388	-95,27623
1480	24-06-2021 12:33:15000	1261,0201	398,232849	1322,4073	397,516022	229,50618	1922,5347	50,031757	-95,357918
1481	24-06-2021 12:33:20000	1260,5592	400,229706	1322,5707	397,525238	229,511505	1922,7548	50,020981	-95,311287
1482	24-06-2021 12:33:25000	1251,2443	398,970734	1313,3125	397,930542	229,745514	1907,2751	50,043736	-95,273911
1483	24-06-2021 12:33:30000	1255,3621	384,413086	1312,9004	397,521332	229,509247	1908,7847	50,059917	-95,61747
1484	24-06-2021 12:33:35000	1260,2518	401,120148	1322,5476	397,30246	229,382874	1923,7687	50,053413	-95,289719
1485	24-06-2021 12:33:40000	1262,988	393,192719	1322,7771	397,349213	229,409882	1923,7983	50,035198	-95,480034
1486	24-06-2021 12:33:45000	1254,1124	398,76712	1315,9838	397,829224	229,687012	1911,7152	50,054447	-95,298477
1487	24-06-2021 12:33:50000	1262,2711	402,556549	1324,9076	397,366272	229,419708	1926,8794	50,045883	-95,272392
1488	24-06-2021 12:33:55000	1262,7911	397,115387	1323,7605	397,364868	229,418915	1925,2499	50,033329	-95,394226
1489	24-06-2021 12:34:00000	1268,2501	395,793335	1328,5747	397,120819	229,278015	1933,472	50,008053	-95,45945
1490	24-06-2021 12:34:05000	1264,8793	398,130524	1326,0571	397,359344	229,415726	1928,5939	49,97998	-95,386482
1491	24-06-2021 12:34:10000	1257,2273	392,153229	1316,9679	397,813171	229,67775	1913,2471	49,976486	-95,463768
1492	24-06-2021 12:34:15000	1249,2589	403,232361	1312,724	398,093475	229,839569	1905,667	50,011337	-95,16539
1493	24-06-2021 12:34:20000	1252,5704	400,953613	1315,1792	397,860077	229,704819	1910,3881	50,040829	-95,239525
1494	24-06-2021 12:34:25000	1256,8456	395,218658	1317,5199	397,42691	229,454712	1915,8499	50,041855	-95,394814
1495	24-06-2021 12:34:30000	1254,7841	396,747314	1316,0136	397,784149	229,66098	1911,9956	50,059357	-95,347359
1496	24-06-2021 12:34:35000	1261,4738	399,296631	1323,1604	397,423828	229,452957	1924,0682	50,051205	-95,337921

1497	24-06-2021 12:34:40000	1269,3005	399,225067	1330,603	397,530121	229,514313	1934,4336	50,009457	-95,392876
1498	24-06-2021 12:34:45000	1253,2733	407,715393	1317,9248	398,255066	229,932846	1912,5096	50,026554	-95,094444
1499	24-06-2021 12:34:50000	1255,7521	389,277985	1314,7056	397,605774	229,557983	1911,0043	50,048832	-95,515846
1500	24-06-2021 12:34:55000	1264,6223	397,354095	1325,5792	397,332733	229,400345	1928,0659	50,047997	-95,401505
1501	24-06-2021 12:35:00000	1263,2377	398,68631	1324,6586	397,430756	229,45694	1926,2531	50,026337	-95,363266
1502	24-06-2021 12:35:05000	1259,3398	398,915619	1321,0112	397,604614	229,557312	1920,0758	50,014217	-95,331505
1503	24-06-2021 12:35:10000	1255,9536	395,458405	1316,741	397,945374	229,754059	1912,3693	50,030392	-95,383499
1504	24-06-2021 12:35:15000	1252,3469	396,948395	1313,7507	397,822296	229,682999	1908,6414	50,053699	-95,326073
1505	24-06-2021 12:35:20000	1261,1904	405,336884	1324,7261	397,825897	229,685074	1924,4785	50,043125	-95,203865
1506	24-06-2021 12:35:25000	1255,6442	395,617401	1316,4937	397,885376	229,719421	1912,2158	50,052113	-95,377914
1507	24-06-2021 12:35:30000	1256,3866	398,533569	1318,0804	397,704987	229,615265	1915,4095	50,060585	-95,319412
1508	24-06-2021 12:35:35000	1258,9235	396,645782	1319,9304	397,843201	229,695084	1917,3917	50,06139	-95,378021
1509	24-06-2021 12:35:40000	1256,8474	399,420471	1318,788	397,959351	229,762115	1915,2012	50,07188	-95,303207
1510	24-06-2021 12:35:45000	1265,8817	386,812897	1323,6619	397,510712	229,503113	1924,5454	50,04842	-95,634827
1511	24-06-2021 12:35:50000	1260,7906	402,180298	1323,3827	398,108337	229,848145	1921,1107	50,036648	-95,270287
1512	24-06-2021 12:35:55000	1258,3356	402,332001	1321,0902	397,906372	229,731537	1918,8037	50,036522	-95,249779
1513	24-06-2021 12:36:00000	1261,9341	391,432404	1321,2483	397,78418	229,660995	1919,5426	50,027592	-95,51075
1514	24-06-2021 12:36:05000	1260,4038	399,013458	1322,0549	397,608948	229,55983	1921,5741	50,022038	-95,336716
1515	24-06-2021 12:36:10000	1261,3954	402,825409	1324,1552	397,581421	229,54393	1924,7644	50,012554	-95,260399
1516	24-06-2021 12:36:15000	1248,6254	392,809143	1308,9553	398,021851	229,798203	1900,6375	50,03854	-95,390976
1517	24-06-2021 12:36:20000	1255,5063	398,653687	1317,2778	397,77066	229,653183	1913,932	50,062679	-95,310669
1518	24-06-2021 12:36:25000	1267,2332	399,561462	1328,7322	397,549377	229,525452	1931,6143	50,03511	-95,371597
1519	24-06-2021 12:36:30000	1262,4513	395,929779	1323,0811	397,824615	229,684341	1922,2123	50,022797	-95,417526
1520	24-06-2021 12:36:35000	1260,719	400,895264	1322,9246	397,628357	229,57103	1922,6985	50,022606	-95,297874
1521	24-06-2021 12:36:40000	1259,067	401,039215	1321,394	397,888977	229,721497	1919,3069	50,022385	-95,283234
1522	24-06-2021 12:36:45000	1262,9452	392,993439	1322,6771	397,707825	229,616913	1922,1373	50,015362	-95,484024
1523	24-06-2021 12:36:50000	1256,3875	399,279449	1318,3071	397,594391	229,551407	1916,3412	50,024052	-95,303093
1524	24-06-2021 12:36:55000	1257,4292	397,359253	1318,72	397,719574	229,623688	1916,2642	50,039276	-95,352249
1525	24-06-2021 12:37:00000	1257,8533	391,26709	1317,3021	397,549042	229,525208	1915,0914	50,044296	-95,487076
1526	24-06-2021 12:37:05000	1253,0032	413,215271	1319,3801	398,106964	229,847351	1915,1953	50,075855	-94,969086



1527	24-06-2021 12:37:10000	1259,8027	399,224701	1321,5458	397,478058	229,484238	1921,474	50,078636	-95,327965
1528	24-06-2021 12:37:15000	1267,3346	400,737061	1329,1829	397,293182	229,377518	1933,4611	50,048954	-95,346893
1529	24-06-2021 12:37:20000	1264,5773	403,024414	1327,2469	397,47699	229,483627	1929,7261	50,028202	-95,278221
1530	24-06-2021 12:37:25000	1260,1154	398,0578	1321,4919	397,771179	229,653488	1919,9092	50,017994	-95,355515
1531	24-06-2021 12:37:30000	1245,8588	399,04303	1308,2046	398,336273	229,979736	1897,9563	50,078655	-95,234238
1532	24-06-2021 12:37:35000	1254,3812	403,027374	1317,537	398,037201	229,807053	1912,9082	50,103603	-95,206543
1533	24-06-2021 12:37:40000	1263,9755	399,615967	1325,6421	397,720367	229,62413	1926,2827	50,086079	-95,348167
1534	24-06-2021 12:37:45000	1267,9753	397,992126	1328,9691	397,665436	229,592438	1931,3011	50,05056	-95,410439
1535	24-06-2021 12:37:50000	1259,2466	394,778564	1319,6787	398,001373	229,786392	1916,2783	50,047455	-95,420692
1536	24-06-2021 12:37:55000	1263,9659	394,751831	1324,1749	397,820709	229,682083	1923,6389	50,048653	-95,453102
1537	24-06-2021 12:38:00000	1261,4104	399,333527	1323,1112	397,69989	229,61232	1922,6831	50,043839	-95,336685
1538	24-06-2021 12:38:05000	1260,1458	402,339264	1322,8168	397,822998	229,683411	1921,6848	50,039383	-95,262306
1539	24-06-2021 12:38:10000	1256,0526	398,502197	1317,7528	398,163818	229,880173	1912,6835	50,066483	-95,31778
1540	24-06-2021 12:38:15000	1257,5945	395,018494	1318,1742	398,012878	229,79303	1913,9255	50,074654	-95,404266
1541	24-06-2021 12:38:20000	1255,5261	396,390167	1316,6134	398,204559	229,903702	1910,782	50,093254	-95,360268
1542	24-06-2021 12:38:25000	1262,9674	402,027863	1325,4105	397,561523	229,53244	1926,7764	50,08757	-95,288773
1543	24-06-2021 12:38:30000	1266,8502	401,130493	1328,8398	397,23584	229,344421	1933,1437	50,050156	-95,33506
1544	24-06-2021 12:38:35000	1268,123	384,270416	1325,066	397,603027	229,556427	1925,9686	50,030151	-95,702637
1545	24-06-2021 12:38:40000	1257,1782	403,660828	1320,3936	398,061157	229,820908	1917,0007	50,038956	-95,212387
1546	24-06-2021 12:38:45000	1251,8037	397,652435	1313,4458	397,779663	229,658386	1908,3569	50,064121	-95,306839
1547	24-06-2021 12:38:50000	1260,619	396,902191	1321,6246	397,63031	229,572159	1920,8586	50,069576	-95,384041
1548	24-06-2021 12:38:55000	1270,2697	391,670135	1329,282	397,351654	229,41127	1933,3478	50,042461	-95,560585
1549	24-06-2021 12:39:00000	1268,1239	401,42453	1330,1427	397,646881	229,581726	1933,2413	50,008308	-95,337425
1550	24-06-2021 12:39:05000	1255,203	395,270569	1315,9686	398,057159	229,818604	1910,7751	50,023468	-95,382439
1551	24-06-2021 12:39:10000	1245,2841	399,978485	1307,9431	398,437256	230,03804	1897,2565	50,071693	-95,209343
1552	24-06-2021 12:39:15000	1261,2667	402,691132	1323,9916	397,315582	229,390442	1925,8982	50,080318	-95,262436
1553	24-06-2021 12:39:20000	1265,458	394,583618	1325,549	397,386505	229,431396	1927,8839	50,046501	-95,466705
1554	24-06-2021 12:39:25000	1259,546	406,695465	1323,5775	397,649414	229,583176	1923,7001	50,032127	-95,162239
1555	24-06-2021 12:39:30000	1261,0355	395,250671	1321,527	397,602325	229,555984	1920,9447	50,029846	-95,422607
1556	24-06-2021 12:39:35000	1259,0748	403,861359	1322,2607	397,348053	229,409195	1923,1741	50,030056	-95,221375

1557	24-06-2021 12:39:40000	1259,2316	391,656708	1318,734	397,416626	229,448792	1917,8225	50,020187	-95,487923
1558	24-06-2021 12:39:45000	1263,6572	396,220642	1324,3188	397,4776	229,483994	1925,6033	50,004433	-95,419411
1559	24-06-2021 12:39:50000	1252,4476	401,279541	1315,1617	398,037354	229,807159	1909,7264	50,024784	-95,231453
1560	24-06-2021 12:39:55000	1251,0924	398,840485	1313,1282	398,057312	229,818665	1906,6541	50,059616	-95,275719
1561	24-06-2021 12:40:00000	1255,1877	398,892029	1317,0463	397,805298	229,673187	1913,489	50,074482	-95,30323
1562	24-06-2021 12:40:05000	1268,7462	403,962341	1331,5038	397,199951	229,3237	1937,3959	50,044098	-95,286705
1563	24-06-2021 12:40:10000	1265,6187	394,457428	1325,6648	397,621765	229,56723	1926,8496	50,010174	-95,47049
1564	24-06-2021 12:40:15000	1260,547	385,250458	1318,1034	397,943695	229,753082	1914,3174	50,017345	-95,633392
1565	24-06-2021 12:40:20000	1260,5105	401,346802	1322,8628	397,769257	229,652374	1922,0376	50,025784	-95,28656
1566	24-06-2021 12:40:25000	1255,4365	403,866974	1318,7986	397,871613	229,711487	1915,5607	50,037441	-95,19548
1567	24-06-2021 12:40:30000	1253,5675	396,337311	1314,7299	398,010132	229,791443	1909,031	50,057175	-95,347908
1568	24-06-2021 12:40:35000	1260,1666	400,947723	1322,4142	397,798004	229,668961	1921,2828	50,063629	-95,292892
1569	24-06-2021 12:40:40000	1254,7496	399,393127	1316,7808	398,071625	229,826935	1911,8746	50,074135	-95,289185
1570	24-06-2021 12:40:45000	1261,1486	398,632843	1322,6503	397,726837	229,627884	1921,9877	50,065937	-95,350113
1571	24-06-2021 12:40:50000	1266,5592	393,325317	1326,2266	397,659424	229,588974	1927,4656	50,030972	-95,500961
1572	24-06-2021 12:40:55000	1259,8036	399,392822	1321,5974	397,802124	229,671356	1920,0718	50,016102	-95,32431
1573	24-06-2021 12:41:00000	1258,9431	399,022644	1320,6652	398,005341	229,788681	1917,6848	50,020447	-95,326431
1574	24-06-2021 12:41:05000	1257,1814	406,569061	1321,2886	397,712952	229,619858	1920,0232	50,02565	-95,148132
1575	24-06-2021 12:41:10000	1259,1803	387,26001	1317,3857	397,868256	229,709518	1913,5844	50,024708	-95,581741
1576	24-06-2021 12:41:15000	1257,5697	402,787964	1320,4998	397,962219	229,763779	1917,6104	50,038776	-95,234375
1577	24-06-2021 12:41:20000	1258,6603	392,954346	1318,5745	397,790588	229,664688	1915,6893	50,035755	-95,456131
1578	24-06-2021 12:41:25000	1265,23	398,484131	1326,4978	397,453308	229,469955	1928,8619	50,014149	-95,381233
1579	24-06-2021 12:41:30000	1259,2927	396,43988	1320,2206	398,043457	229,810669	1916,98	50,009438	-95,385017
1580	24-06-2021 12:41:35000	1256,4213	402,830322	1319,4191	398,093445	229,839523	1915,4906	50,022972	-95,225334
1581	24-06-2021 12:41:40000	1261,7754	393,496887	1321,7098	397,983948	229,776321	1919,5638	50,024269	-95,465385
1582	24-06-2021 12:41:45000	1249,0913	403,499146	1312,6465	398,066864	229,824173	1905,9252	50,058815	-95,158249
1583	24-06-2021 12:41:50000	1260,9022	407,599609	1325,1459	397,828979	229,686844	1925,0989	50,063011	-95,151947
1584	24-06-2021 12:41:55000	1270,48	396,477997	1330,9073	397,570923	229,537872	1934,8044	50,031284	-95,459694
1585	24-06-2021 12:42:00000	1266,4684	396,871399	1327,1959	397,45459	229,470718	1929,8431	50,004433	-95,42437
1586	24-06-2021 12:42:05000	1259,6014	400,495422	1321,7384	397,761963	229,648163	1920,6567	49,999447	-95,298843

1587	24-06-2021 12:42:10000	1258,7336	403,672455	1321,8782	397,516602	229,5065	1921,958	49,996304	-95,223122
1588	24-06-2021 12:42:15000	1263,9111	394,052399	1323,9142	397,274475	229,366714	1926,0898	49,986835	-95,467758
1589	24-06-2021 12:42:20000	1259,146	396,942902	1320,2319	397,56546	229,534698	1919,2961	49,980762	-95,373093
1590	24-06-2021 12:42:25000	1260,1531	393,89859	1320,2809	397,425751	229,454041	1920,0641	49,980206	-95,445824
1591	24-06-2021 12:42:30000	1248,9518	398,487579	1310,9817	397,868866	229,709869	1904,4438	50,008904	-95,26844
1592	24-06-2021 12:42:35000	1255,2891	405,779694	1319,2451	397,699463	229,612061	1917,3241	50,030384	-95,152069
1593	24-06-2021 12:42:40000	1262,1233	398,434601	1323,5201	397,412933	229,446655	1924,824	50,02029	-95,361099
1594	24-06-2021 12:42:45000	1257,2778	396,164154	1318,2159	397,662994	229,591019	1915,8661	50,025204	-95,37722
1595	24-06-2021 12:42:50000	1251,4512	391,145294	1311,1539	400,104889	231,000854	1894,4019	50,048824	-95,446548
1596	24-06-2021 12:42:55000	1254,6244	396,468079	1315,7771	400,058594	230,974121	1901,1354	50,076626	-95,352356
1597	24-06-2021 12:43:00000	1267,2114	395,216492	1327,4114	399,470459	230,634552	1920,8051	50,054501	-95,464867
1598	24-06-2021 12:43:05000	1257,4109	396,684845	1318,4995	399,921112	230,894745	1905,7289	50,049263	-95,366806
1599	24-06-2021 12:43:10000	1259,3054	394,740143	1319,7234	399,785034	230,816177	1908,1572	50,052273	-95,421921
1600	24-06-2021 12:43:15000	1265,1707	394,837677	1325,3503	399,519043	230,662613	1917,6031	50,032608	-95,459335
1601	24-06-2021 12:43:20000	1260,9595	400,249298	1322,9583	399,890625	230,877151	1912,4485	50,026096	-95,313629
1602	24-06-2021 12:43:25000	1264,4025	401,010193	1326,47	399,705872	230,770477	1918,3514	50,007401	-95,320847
1603	24-06-2021 12:43:30000	1264,6613	392,159363	1324,0684	399,752289	230,797287	1914,6415	49,995316	-95,51329
1604	24-06-2021 12:43:35000	1242,3665	397,815399	1304,5044	400,901611	231,460846	1880,9613	50,047707	-95,236671
1605	24-06-2021 12:43:40000	1249,8738	395,857117	1311,0634	400,489471	231,222885	1892,3569	50,09642	-95,332825
1606	24-06-2021 12:43:45000	1258,5388	393,924408	1318,7479	399,977509	230,927307	1905,7933	50,097183	-95,434364
1607	24-06-2021 12:43:50000	1263,3838	400,633453	1325,3851	400,050598	230,969513	1915,0712	50,079182	-95,322014
1608	24-06-2021 12:43:55000	1258,3966	399,639465	1320,3309	400,115356	231,006882	1907,4352	50,075226	-95,309181
1609	24-06-2021 12:44:00000	1268,2593	393,690216	1327,9585	399,947418	230,909943	1919,2515	50,050217	-95,50444
1610	24-06-2021 12:44:05000	1265,7153	396,491608	1326,3638	400,007721	230,944748	1916,7627	50,027218	-95,427467
1611	24-06-2021 12:44:10000	1261,7216	395,890533	1322,373	400,096893	230,996231	1910,6509	49,99839	-95,413429
1612	24-06-2021 12:44:15000	1256,4651	390,524811	1315,7562	400,246124	231,082397	1900,2611	50,007008	-95,493767
1613	24-06-2021 12:44:20000	1253,6691	405,745148	1317,6931	400,275085	231,099106	1902,9692	50,029949	-95,141197
1614	24-06-2021 12:44:25000	1260,8942	398,896362	1322,4872	400,183716	231,046356	1910,2512	50,044132	-95,342636
1615	24-06-2021 12:44:30000	1259,3237	408,649475	1323,9679	400,196869	231,05394	1912,41	50,050098	-95,117401
1616	24-06-2021 12:44:35000	1267,6169	389,812988	1326,2002	399,497375	230,650101	1918,9269	50,024612	-95,582626

1617	24-06-2021 12:44:40000	1265,2383	401,937347	1327,5472	399,653229	230,740097	1920,0466	49,999702	-95,306465
1618	24-06-2021 12:44:45000	1264,4827	393,413513	1324,2698	399,414124	230,602051	1916,4607	49,985775	-95,485275
1619	24-06-2021 12:44:50000	1262,8771	392,056244	1322,3337	399,846649	230,851776	1911,6268	49,97575	-95,503654
1620	24-06-2021 12:44:55000	1253,9585	395,97113	1314,9924	399,997009	230,938568	1900,3364	49,999287	-95,358612
1621	24-06-2021 12:45:00000	1254,7734	397,072266	1316,1014	399,844269	230,850388	1902,632	50,017529	-95,340187
1622	24-06-2021 12:45:05000	1254,5114	389,377167	1313,5499	399,96524	230,920242	1898,4023	50,04903	-95,505424
1623	24-06-2021 12:45:10000	1252,2068	398,668335	1314,1378	400,196899	231,053986	1898,0946	50,076935	-95,287323
1624	24-06-2021 12:45:15000	1267,1228	396,251617	1327,6354	399,231445	230,496582	1922,146	50,057072	-95,442085
1625	24-06-2021 12:45:20000	1270,8743	394,773956	1330,7772	399,530701	230,669357	1925,2869	50,015999	-95,49865
1626	24-06-2021 12:45:25000	1266,1884	397,230194	1327,036	399,808014	230,829468	1918,5566	49,985451	-95,414764
1627	24-06-2021 12:45:30000	1260,3351	399,848022	1322,2417	399,851471	230,854538	1911,4415	49,9986	-95,318062
1628	24-06-2021 12:45:35000	1258,7079	401,777008	1321,276	399,753082	230,797745	1910,4893	50,003269	-95,264565
1629	24-06-2021 12:45:40000	1255,7866	394,010498	1316,1476	399,911041	230,888931	1902,3809	50,028748	-95,413818
1630	24-06-2021 12:45:45000	1257,7397	399,114441	1319,546	399,829865	230,842072	1907,6212	50,05019	-95,316101
1631	24-06-2021 12:45:50000	1256,5325	405,541046	1320,355	399,652283	230,739548	1909,5454	50,05431	-95,16626
1632	24-06-2021 12:45:55000	1263,5585	394,138916	1323,6033	399,413696	230,601791	1915,4067	50,037827	-95,463539
1633	24-06-2021 12:46:00000	1270,7844	391,775574	1329,8049	399,207764	230,48291	1925,4194	49,988766	-95,561714
1634	24-06-2021 12:46:05000	1262,3856	404,611908	1325,6426	399,427979	230,610031	1918,422	49,965363	-95,228203
1635	24-06-2021 12:46:10000	1264,4738	398,213135	1325,6952	399,297852	230,534912	1918,9987	49,947933	-95,381943
1636	24-06-2021 12:46:15000	1257,4326	396,625763	1318,5024	399,585999	230,701279	1907,1473	49,950222	-95,36824
1637	24-06-2021 12:46:20000	1247,7344	401,053314	1310,6046	399,885468	230,874161	1894,4385	49,998032	-95,20295
1638	24-06-2021 12:46:25000	1251,1134	401,072174	1313,828	399,530945	230,669479	1900,7424	50,037575	-95,226585
1639	24-06-2021 12:46:30000	1258,786	399,855194	1320,7675	399,378754	230,581604	1911,4774	50,05201	-95,307175
1640	24-06-2021 12:46:35000	1267,787	393,611847	1327,4841	398,868927	230,287292	1923,5403	50,022297	-95,502983
1641	24-06-2021 12:46:40000	1268,7902	398,567841	1329,9191	399,267517	230,517395	1925,2898	49,983875	-95,403557
1642	24-06-2021 12:46:45000	1267,1522	401,927277	1329,3683	399,168182	230,460052	1924,9762	49,953751	-95,31987
1643	24-06-2021 12:46:50000	1260,6779	398,514679	1322,1658	399,7034	230,769058	1911,9725	49,960091	-95,349449
1644	24-06-2021 12:46:55000	1250,7504	402,033875	1313,7761	399,868866	230,864578	1899,0781	50,00256	-95,202698
1645	24-06-2021 12:47:00000	1259,9889	396,191132	1320,8102	399,564941	230,689117	1910,7054	50,007977	-95,395157
1646	24-06-2021 12:47:05000	1258,3146	393,972382	1318,5483	399,519501	230,662888	1907,6647	50,026039	-95,431808

1647	24-06-2021 12:47:10000	1257,423	399,640961	1319,4034	399,53653	230,672714	1908,8671	50,025753	-95,302391
1648	24-06-2021 12:47:15000	1259,6238	406,658752	1323,6401	399,628265	230,725662	1914,5326	50,038036	-95,163605
1649	24-06-2021 12:47:20000	1264,3881	401,924286	1326,7329	399,31134	230,542694	1920,4523	50,017273	-95,300873
1650	24-06-2021 12:47:25000	1261,6316	394,29245	1321,8097	399,474335	230,63681	1912,532	50,002144	-95,447296
1651	24-06-2021 12:47:30000	1260,384	394,412048	1320,6547	399,604767	230,712097	1910,2472	49,996353	-95,436302
1652	24-06-2021 12:47:35000	1269,9659	402,739044	1332,2958	399,049835	230,391724	1929,778	49,949936	-95,321617
1653	24-06-2021 12:47:40000	1257,2532	401,261078	1319,7333	399,614349	230,717636	1908,9188	49,942158	-95,265701
1654	24-06-2021 12:47:45000	1254,7378	392,448669	1314,6798	399,723419	230,780624	1901,0431	49,961082	-95,440567
1655	24-06-2021 12:47:50000	1248,4711	404,196167	1312,2706	399,921661	230,895081	1896,6813	50,012527	-95,138222
1656	24-06-2021 12:47:55000	1251,5323	395,714111	1312,6016	399,650177	230,738327	1898,3075	50,037445	-95,347466
1657	24-06-2021 12:48:00000	1261,6545	396,679108	1322,5455	399,415375	230,602768	1913,8738	50,037189	-95,395927
1658	24-06-2021 12:48:05000	1271,0104	391,870758	1330,0488	399,040924	230,386597	1926,4337	49,99437	-95,56118
1659	24-06-2021 12:48:10000	1269,7579	399,905518	1331,2437	399,200226	230,478546	1927,4698	49,956936	-95,381332
1660	24-06-2021 12:48:15000	1260,6971	402,892273	1323,5104	399,642853	230,7341	1914,1013	49,946693	-95,254051
1661	24-06-2021 12:48:20000	1248,731	392,243744	1308,8866	399,967743	230,921677	1891,4962	49,97641	-95,40406
1662	24-06-2021 12:48:25000	1247,2278	393,806366	1307,9221	399,808716	230,829865	1890,8557	50,032597	-95,359474
1663	24-06-2021 12:48:30000	1254,2924	394,417236	1314,8439	399,680817	230,756012	1901,4789	50,050903	-95,394775
1664	24-06-2021 12:48:35000	1262,153	399,214203	1323,7832	399,050171	230,391907	1917,3226	50,056263	-95,344383
1665	24-06-2021 12:48:40000	1260,4447	386,882751	1318,4836	399,512299	230,658722	1907,5023	50,046139	-95,598053
1666	24-06-2021 12:48:45000	1264,973	397,515747	1325,962	399,320435	230,547943	1919,2003	50,025639	-95,400391
1667	24-06-2021 12:48:50000	1266,905	394,411621	1326,8794	399,050751	230,392242	1921,8168	49,999443	-95,480042
1668	24-06-2021 12:48:55000	1266,9308	398,192566	1328,0328	399,059906	230,397537	1923,4458	49,96875	-95,399063
1669	24-06-2021 12:49:00000	1261,1049	395,902588	1321,7883	399,502899	230,653305	1912,3225	49,958317	-95,408989
1670	24-06-2021 12:49:05000	1257,0239	400,252197	1319,2085	399,209991	230,484177	1909,9863	49,970947	-95,286224
1671	24-06-2021 12:49:10000	1258,6973	398,098602	1320,152	398,8862	230,297241	1912,9159	49,969337	-95,344872
1672	24-06-2021 12:49:15000	1252,9591	402,107758	1315,9016	398,968994	230,345032	1906,2734	49,989807	-95,216774
1673	24-06-2021 12:49:20000	1257,1268	397,510742	1318,4774	398,845581	230,273788	1910,6571	49,996098	-95,346863
1674	24-06-2021 12:49:25000	1260,7457	388,651978	1319,2916	398,87207	230,289078	1911,708	49,994289	-95,562332
1675	24-06-2021 12:49:30000	1264,2548	403,183502	1326,988	398,850464	230,276611	1922,9	49,982567	-95,272514
1676	24-06-2021 12:49:35000	1251,9338	393,887756	1312,4352	399,172241	230,462387	1900,4027	50,001118	-95,390152

1677	24-06-2021 12:49:40000	1255,288	398,756531	1317,1008	399,052643	230,393341	1907,5732	50,02235	-95,3069
1678	24-06-2021 12:49:45000	1250,3036	398,681824	1312,3286	399,324341	230,550217	1899,2826	50,05394	-95,273666
1679	24-06-2021 12:49:50000	1262,4482	398,66922	1323,9005	398,700806	230,190201	1918,9913	50,044537	-95,358238
1680	24-06-2021 12:49:55000	1262,5922	394,810852	1322,8811	398,872253	230,289185	1916,7864	50,025078	-95,442596
1681	24-06-2021 12:50:00000	1259,6183	399,432739	1321,4329	398,9664	230,343552	1914,1654	50,032471	-95,322159
1682	24-06-2021 12:50:05000	1262,8329	403,499847	1325,7296	398,620239	230,143677	1922,1162	50,022049	-95,255692
1683	24-06-2021 12:50:10000	1268,9952	398,672974	1330,1462	398,848175	230,275299	1927,3522	49,991791	-95,402687
1684	24-06-2021 12:50:15000	1259,0554	395,932007	1319,8419	398,943787	230,330505	1911,9781	49,998215	-95,394409
1685	24-06-2021 12:50:20000	1251,4723	394,438263	1312,1603	399,301788	230,537186	1899,1801	50,035099	-95,374962
1686	24-06-2021 12:50:25000	1266,3435	406,393341	1329,9554	398,499878	230,074203	1928,7471	50,024796	-95,216988
1687	24-06-2021 12:50:30000	1260,4031	396,400177	1321,2681	398,842163	230,27182	1914,4491	50,017258	-95,393448
1688	24-06-2021 12:50:35000	1253,29	397,176392	1314,7186	399,078156	230,408066	1903,8868	50,031937	-95,327629
1689	24-06-2021 12:50:40000	1257,6711	398,716309	1319,3601	398,808563	230,252426	1911,8665	50,037254	-95,324318
1690	24-06-2021 12:50:45000	1265,485	409,073181	1329,9597	398,601929	230,133118	1928,1616	50,014713	-95,152122
1691	24-06-2021 12:50:50000	1261,892	394,559387	1322,1377	398,791473	230,242554	1915,9849	49,998318	-95,443298
1692	24-06-2021 12:50:55000	1264,4335	400,620972	1326,382	398,673126	230,17424	1922,7126	49,984653	-95,329514
1693	24-06-2021 12:51:00000	1261,6537	399,36554	1323,3529	398,685181	230,181198	1918,2898	49,978252	-95,337662
1694	24-06-2021 12:51:05000	1254,9403	402,199524	1317,8163	399,099091	230,420151	1908,2926	50,000271	-95,228783
1695	24-06-2021 12:51:10000	1251,6995	403,845093	1315,2349	398,882782	230,295273	1905,4877	50,029354	-95,169281
1696	24-06-2021 12:51:15000	1259,3049	404,624939	1322,7133	398,493866	230,07074	1918,2341	50,033035	-95,2062
1697	24-06-2021 12:51:20000	1263,193	397,261169	1324,1877	398,506409	230,077972	1920,2496	50,022125	-95,393806
1698	24-06-2021 12:51:25000	1262,2201	400,020081	1324,0905	398,528961	230,091003	1919,9922	50,006943	-95,327332
1699	24-06-2021 12:51:30000	1260,8676	398,36142	1322,3007	398,746918	230,216827	1916,3331	49,99966	-95,35408
1700	24-06-2021 12:51:35000	1255,9193	400,818512	1318,3279	398,771545	230,231064	1910,4922	50,003323	-95,266068
1701	24-06-2021 12:51:40000	1263,3457	396,911316	1324,2284	398,200623	229,901443	1921,8152	49,98143	-95,402397
1702	24-06-2021 12:51:45000	1259,8331	396,131256	1320,6437	398,391907	230,011871	1915,6737	49,970627	-95,395393
1703	24-06-2021 12:51:50000	1256,0336	403,657196	1319,3026	398,681793	230,179245	1912,3212	49,981373	-95,204353
1704	24-06-2021 12:51:55000	1257,0876	404,563934	1320,5836	398,36795	229,998047	1915,6149	49,992489	-95,191818
1705	24-06-2021 12:52:00000	1257,8925	407,394592	1322,2192	398,593781	230,128433	1916,9177	49,995789	-95,134933
1706	24-06-2021 12:52:05000	1258,6776	394,489777	1319,0494	398,708069	230,194412	1911,7731	50,005569	-95,42308

1707	24-06-2021 12:52:10000	1250,0345	405,938538	1314,2954	398,615509	230,140961	1905,3849	50,042881	-95,110619
1708	24-06-2021 12:52:15000	1262,4105	400,31665	1324,3616	398,336731	229,980011	1921,3472	50,03614	-95,322189
1709	24-06-2021 12:52:20000	1265,8723	401,412323	1327,9927	398,482941	230,064423	1925,9276	50,014935	-95,322235
1710	24-06-2021 12:52:25000	1258,9636	397,947296	1320,3605	398,934937	230,325378	1912,7659	50,012493	-95,349998
1711	24-06-2021 12:52:30000	1255,6945	390,695496	1315,0709	398,884094	230,296036	1905,2651	50,027042	-95,484924
1712	24-06-2021 12:52:35000	1261,0292	403,676697	1324,0654	398,467957	230,055786	1920,2145	50,019867	-95,239182
1713	24-06-2021 12:52:40000	1263,8075	405,506439	1327,2697	398,49881	230,073593	1924,7985	50,001686	-95,21859
1714	24-06-2021 12:52:45000	1260,7556	400,800232	1322,9308	398,822632	230,260544	1916,9324	49,997261	-95,300201
1715	24-06-2021 12:52:50000	1250,9236	400,441254	1313,4546	398,93158	230,323441	1902,7578	50,027222	-95,239197
1716	24-06-2021 12:52:55000	1254,3375	403,906921	1317,7645	399,063232	230,39946	1908,3424	50,04985	-95,186768
1717	24-06-2021 12:53:00000	1257,2588	403,419525	1320,3965	398,760956	230,224945	1913,6316	50,058929	-95,218277
1718	24-06-2021 12:53:05000	1264,1333	409,065094	1328,6713	398,526886	230,089798	1926,7119	50,036835	-95,14267
1719	24-06-2021 12:53:10000	1270,5885	399,185944	1331,8201	398,038849	229,808029	1933,6063	49,978855	-95,40242
1720	24-06-2021 12:53:15000	1261,6834	402,062317	1324,1975	398,437622	230,038254	1920,6631	49,957546	-95,279091
1721	24-06-2021 12:53:20000	1259,9211	395,694183	1320,5966	398,263611	229,93779	1916,2319	49,959274	-95,405457
1722	24-06-2021 12:53:25000	1262,3367	395,283752	1322,7786	398,122894	229,856552	1920,0521	49,950771	-95,430687
1723	24-06-2021 12:53:30000	1260,8585	406,629669	1324,8063	398,17749	229,888077	1922,7826	49,944069	-95,173042
1724	24-06-2021 12:53:35000	1253,2118	403,84201	1316,6732	398,53299	230,093323	1909,2161	49,9673	-95,180176
1725	24-06-2021 12:53:40000	1253,1094	402,027008	1316,02	398,160614	229,878311	1910,1272	49,990635	-95,219627
1726	24-06-2021 12:53:45000	1259,7585	409,114655	1324,5249	397,945099	229,753891	1923,5947	49,987122	-95,110214
1727	24-06-2021 12:53:50000	1257,7598	399,203644	1319,5922	398,079956	229,831757	1915,7521	49,992073	-95,314285
1728	24-06-2021 12:53:55000	1249,9451	402,844543	1313,2579	398,867981	230,286713	1902,8174	50,036789	-95,178947
1729	24-06-2021 12:54:00000	1253,5732	406,799561	1317,927	398,302948	229,960495	1912,3185	50,064781	-95,117043
1730	24-06-2021 12:54:05000	1260,2816	400,749115	1322,4635	398,297241	229,957199	1918,8152	50,057556	-95,298027
1731	24-06-2021 12:54:10000	1261,7554	405,323029	1325,2599	398,415253	230,025345	1922,3425	50,039848	-95,208153
1732	24-06-2021 12:54:15000	1261,9698	402,287384	1324,5388	398,54422	230,099808	1920,6572	50,027164	-95,276169
1733	24-06-2021 12:54:20000	1257,9871	402,163483	1320,707	398,617493	230,14209	1914,7684	50,02309	-95,251038
1734	24-06-2021 12:54:25000	1256,9182	399,203888	1318,79	398,532318	230,092926	1912,3934	50,026157	-95,308441
1735	24-06-2021 12:54:30000	1261,1287	399,44458	1322,8762	398,332733	229,977707	1919,2484	50,029762	-95,332329
1736	24-06-2021 12:54:35000	1261,0612	403,052979	1323,906	398,438934	230,039017	1920,2189	50,014729	-95,253075

1737	24-06-2021 12:54:40000	1253,9431	397,527161	1315,4471	398,903809	230,307404	1905,7927	50,031216	-95,324478
1738	24-06-2021 12:54:45000	1251,7443	403,149658	1315,064	398,712708	230,197067	1906,0612	50,056744	-95,185043
1739	24-06-2021 12:54:50000	1258,5424	398,206207	1320,0369	398,584564	230,123093	1913,8888	50,059795	-95,341461
1740	24-06-2021 12:54:55000	1259,4423	407,416016	1323,7004	398,420441	230,028336	1920,0112	50,047554	-95,145569
1741	24-06-2021 12:55:00000	1267,3308	397,078888	1328,0809	398,420105	230,028152	1926,4312	50,021118	-95,42572
1742	24-06-2021 12:55:05000	1267,121	401,647705	1329,2542	398,470062	230,056992	1927,8491	49,999687	-95,325714
1743	24-06-2021 12:55:10000	1256,9083	404,530975	1320,403	398,807312	230,251709	1913,3763	50,003468	-95,191269
1744	24-06-2021 12:55:15000	1254,8369	398,978973	1316,7383	398,774109	230,232529	1908,2365	50,015102	-95,298882
1745	24-06-2021 12:55:20000	1259,4247	405,236511	1323,0144	398,427307	230,032303	1919,0089	50,028046	-95,193573
1746	24-06-2021 12:55:25000	1260,5994	409,634033	1325,4851	398,419861	230,028015	1922,5713	50,024124	-95,104752
1747	24-06-2021 12:55:30000	1260,1008	398,702423	1321,6722	398,505157	230,077255	1916,656	50,015953	-95,341393
1748	24-06-2021 12:55:35000	1250,5032	419,114136	1318,8688	398,854553	230,278976	1911,9888	50,012016	-94,816345
1749	24-06-2021 12:55:40000	1254,8063	391,600464	1314,4922	398,542175	230,098618	1906,3342	50,015926	-95,459396
1750	24-06-2021 12:55:45000	1253,7467	409,861633	1319,0404	398,574829	230,117477	1912,6591	50,028866	-95,049919
1751	24-06-2021 12:55:50000	1258,087	390,242615	1317,2214	398,474457	230,059525	1910,4337	50,030262	-95,510674
1752	24-06-2021 12:55:55000	1258,4183	403,547516	1321,5397	398,652039	230,162048	1915,7568	50,029202	-95,223648
1753	24-06-2021 12:56:00000	1262,2218	404,066284	1325,3202	398,679871	230,178131	1921,1332	50,014923	-95,239014
1754	24-06-2021 12:56:05000	1241,8722	397,154968	1303,8323	399,676483	230,753525	1885,3041	50,067814	-95,247849
1755	24-06-2021 12:56:10000	1257,5581	403,774323	1320,7899	398,848999	230,275757	1913,7255	50,08593	-95,21257
1756	24-06-2021 12:56:15000	1257,9672	404,426025	1321,3787	398,876526	230,291672	1914,4053	50,081928	-95,201103
1757	24-06-2021 12:56:20000	1262,6892	401,526764	1324,9935	398,986603	230,355209	1919,1832	50,070721	-95,297768
1758	24-06-2021 12:56:25000	1264,8502	405,720856	1328,3281	399,212067	230,485397	1922,9364	50,052673	-95,221222
1759	24-06-2021 12:56:30000	1248,1266	403,469391	1311,7192	399,626892	230,724884	1896,9017	50,084332	-95,151955
1760	24-06-2021 12:56:35000	1262,6105	398,821411	1324,1011	399,173462	230,463104	1916,9414	50,087212	-95,356049
1761	24-06-2021 12:56:40000	1265,1129	414,945221	1331,4241	398,795013	230,244598	1929,3585	50,045574	-95,019524
1762	24-06-2021 12:56:45000	1266,4094	398,076294	1327,5005	398,84082	230,271057	1923,4739	50,006115	-95,398041
1763	24-06-2021 12:56:50000	1255,95	403,607025	1319,2076	399,178192	230,465836	1909,9336	50,009674	-95,204872
1764	24-06-2021 12:56:55000	1259,2011	401,283783	1321,5959	399,095886	230,418335	1913,6826	50,012482	-95,278816
1765	24-06-2021 12:57:00000	1256,4115	402,384857	1319,2738	399,274628	230,5215	1909,5891	50,019821	-95,235085
1766	24-06-2021 12:57:05000	1254,6447	397,026917	1315,965	399,472198	230,63559	1903,8087	50,029408	-95,340286



1767	24-06-2021 12:57:10000	1246,2233	395,611328	1307,5093	399,841553	230,848831	1889,8422	50,081268	-95,312759
1768	24-06-2021 12:57:15000	1255,2802	403,232452	1318,4554	399,193665	230,474762	1908,7045	50,096199	-95,208389
1769	24-06-2021 12:57:20000	1266,9403	397,963867	1327,9731	398,960724	230,340286	1923,5933	50,058769	-95,404053
1770	24-06-2021 12:57:25000	1259,3629	394,767792	1319,7866	399,514923	230,660263	1909,1537	50,045696	-95,421715
1771	24-06-2021 12:57:30000	1257,1606	402,775146	1320,1063	399,524017	230,665512	1909,4946	50,051682	-95,231773
1772	24-06-2021 12:57:35000	1255,049	404,301453	1318,5627	399,443237	230,618851	1907,6858	50,065075	-95,183113
1773	24-06-2021 12:57:40000	1258,0178	393,46051	1318,1122	399,152374	230,450928	1908,4702	50,071217	-95,440865
1774	24-06-2021 12:57:45000	1264,2727	395,284454	1324,6265	399,223389	230,491928	1917,4817	50,057205	-95,443718
1775	24-06-2021 12:57:50000	1254,3065	405,795715	1318,3152	399,821075	230,837021	1905,5403	50,075996	-95,144661
1776	24-06-2021 12:57:55000	1260,6884	404,20459	1323,9021	399,334778	230,556244	1915,8956	50,074352	-95,225204
1777	24-06-2021 12:58:00000	1256,3077	400,880829	1318,7169	399,491913	230,646957	1907,6371	50,083076	-95,267426
1778	24-06-2021 12:58:05000	1253,9771	407,144318	1318,4176	399,456726	230,626633	1907,3638	50,101669	-95,112282
1779	24-06-2021 12:58:10000	1265,0298	405,093323	1328,3076	398,845306	230,273636	1924,5459	50,071815	-95,236214
1780	24-06-2021 12:58:15000	1272,2654	403,181396	1334,6215	398,799377	230,247147	1933,9481	50,010071	-95,327805
1781	24-06-2021 12:58:20000	1253,9128	401,987793	1316,7732	400,03479	230,960403	1902,2633	50,020794	-95,226181
1782	24-06-2021 12:58:25000	1246,2327	402,035614	1309,4766	399,92746	230,898438	1892,2015	50,068123	-95,170303
1783	24-06-2021 12:58:30000	1250,8711	401,371521	1313,6885	399,638092	230,731369	1899,6392	50,10664	-95,218239
1784	24-06-2021 12:58:35000	1260,9952	410,926056	1326,2614	399,105072	230,42363	1920,3186	50,100655	-95,078941
1785	24-06-2021 12:58:40000	1271,1006	403,470856	1333,5986	399,014221	230,371185	1931,433	50,049816	-95,313576
1786	24-06-2021 12:58:45000	1257,5544	400,932373	1319,9205	399,52005	230,663223	1909,3063	50,037411	-95,275017
1787	24-06-2021 12:58:50000	1257,696	393,80307	1317,9075	399,640137	230,732559	1905,7429	50,046368	-95,431282
1788	24-06-2021 12:58:55000	1249,6376	409,246735	1314,9437	399,700897	230,767624	1901,1879	50,079849	-95,033539
1789	24-06-2021 12:59:00000	1258,869	403,558502	1321,9723	399,219299	230,489578	1913,6547	50,088188	-95,226585
1790	24-06-2021 12:59:05000	1255,7778	398,060089	1317,3572	399,363892	230,573059	1906,2166	50,096249	-95,325546
1791	24-06-2021 12:59:10000	1258,5609	400,037445	1320,608	399,123383	230,434189	1912,125	50,097626	-95,301628
1792	24-06-2021 12:59:15000	1260,9911	402,412964	1323,6444	399,300507	230,536453	1915,6472	50,083374	-95,266602
1793	24-06-2021 12:59:20000	1256,969	402,827972	1319,9398	399,437286	230,615417	1909,7227	50,082211	-95,229256
1794	24-06-2021 12:59:25000	1254,0096	401,605377	1316,7485	399,511902	230,658508	1904,713	50,103165	-95,235306
1795	24-06-2021 12:59:30000	1256,1244	399,652008	1318,1693	399,372742	230,578156	1907,4247	50,107506	-95,293106
1796	24-06-2021 12:59:35000	1249,5638	393,960327	1310,1964	399,615417	230,718262	1894,8662	50,135372	-95,372253

1797	24-06-2021 12:59:40000	1262,8477	401,687714	1325,1934	399,184784	230,469635	1918,4797	50,125729	-95,295357
1798	24-06-2021 12:59:45000	1271,1262	405,483978	1334,2335	399,129303	230,437607	1931,8873	50,076054	-95,270142
1799	24-06-2021 12:59:50000	1261,2295	401,888092	1323,7123	399,633057	230,728455	1914,2556	50,059662	-95,279739
1800	24-06-2021 12:59:55000	1261,9341	401,330139	1324,2144	399,291565	230,531296	1916,5584	50,047894	-95,296814
1801	24-06-2021 13:00:00000	1256,218	406,6409	1320,3943	399,277527	230,523163	1911,1569	50,049023	-95,139626
1802	24-06-2021 13:00:05000	1257,5802	401,71817	1320,184	399,011597	230,369644	1912,078	50,050068	-95,257957
1803	24-06-2021 13:00:10000	1255,8378	407,293396	1320,2334	399,094604	230,417572	1911,7705	50,057793	-95,122398
1804	24-06-2021 13:00:15000	1252,8174	397,4375	1314,347	399,057465	230,396133	1903,4617	50,068531	-95,318619
1805	24-06-2021 13:00:20000	1256,5465	402,13382	1319,3258	399,215515	230,487381	1910,014	50,083775	-95,241554
1806	24-06-2021 13:00:25000	1250,1318	403,947327	1313,7743	399,305634	230,539398	1901,4299	50,11343	-95,155746
1807	24-06-2021 13:00:30000	1249,2362	394,871674	1310,1582	399,173859	230,463333	1896,7672	50,141338	-95,350021
1808	24-06-2021 13:00:35000	1255,7633	408,6427	1320,5795	398,929596	230,322296	1913,1305	50,145416	-95,091835
1809	24-06-2021 13:00:40000	1265,3845	400,583496	1327,2773	398,720062	230,201309	1923,8401	50,09565	-95,336861
1810	24-06-2021 13:00:45000	1255,791	397,669464	1317,2517	399,22876	230,495026	1906,8386	50,101143	-95,334175
1811	24-06-2021 13:00:50000	1260,2025	397,701782	1321,4678	399,054138	230,394196	1913,8914	50,08416	-95,363846
1812	24-06-2021 13:00:55000	1259,6295	402,497833	1322,3732	399,043549	230,388092	1915,1764	50,076103	-95,255219
1813	24-06-2021 13:01:00000	1258,6132	396,868866	1319,7015	399,270569	230,519165	1910,3136	50,069519	-95,371048
1814	24-06-2021 13:01:05000	1257,5393	406,386139	1321,5729	399,230804	230,496216	1913,1943	50,063679	-95,154747
1815	24-06-2021 13:01:10000	1258,5226	406,355774	1322,4991	399,243591	230,503586	1914,4459	50,058743	-95,162445
1816	24-06-2021 13:01:15000	1255,9004	393,738861	1316,1748	399,079437	230,408813	1906,1136	50,065327	-95,420486
1817	24-06-2021 13:01:20000	1261,5946	397,596039	1322,7636	399,126801	230,436157	1915,449	50,058441	-95,375664
1818	24-06-2021 13:01:25000	1257,1844	408,032959	1321,7427	399,166626	230,459137	1913,7482	50,064056	-95,115677
1819	24-06-2021 13:01:30000	1250,7413	391,800079	1310,6721	399,493286	230,647751	1896,2247	50,093235	-95,427483
1820	24-06-2021 13:01:35000	1257,1396	403,230103	1320,2252	398,977295	230,349823	1912,3995	50,099415	-95,221603
1821	24-06-2021 13:01:40000	1271,3084	401,856384	1333,3092	398,300385	229,95903	1934,6664	50,04694	-95,349854
1822	24-06-2021 13:01:45000	1265,4753	397,262543	1326,3655	399,224792	230,492722	1920,1647	50,028984	-95,409248
1823	24-06-2021 13:01:50000	1254,176	412,536285	1320,2816	399,322449	230,549118	1910,8459	50,039913	-94,993065
1824	24-06-2021 13:01:55000	1251,2974	393,092926	1311,5895	399,197723	230,477112	1899,0204	50,070507	-95,403122
1825	24-06-2021 13:02:00000	1252,2144	402,170929	1315,2119	399,296906	230,534363	1903,6483	50,097126	-95,210091
1826	24-06-2021 13:02:05000	1259,4359	407,542755	1323,7333	399,106934	230,424683	1916,8535	50,095139	-95,142723

1827	24-06-2021 13:02:10000	1267,8011	400,171753	1329,4574	398,770599	230,230499	1926,7686	50,067886	-95,362297
1828	24-06-2021 13:02:15000	1266,7811	404,677521	1329,849	398,848663	230,275589	1927,0083	50,026489	-95,257515
1829	24-06-2021 13:02:20000	1261,0586	397,919922	1322,3497	399,308105	230,540833	1913,915	50,00774	-95,364975
1830	24-06-2021 13:02:25000	1247,7023	401,814056	1310,8073	399,52829	230,667969	1896,2006	50,048874	-95,185799
1831	24-06-2021 13:02:30000	1254,4857	405,285492	1318,3287	399,067688	230,402023	1909,3367	50,080746	-95,157272
1832	24-06-2021 13:02:35000	1259,2167	394,515106	1319,5715	398,822754	230,260605	1912,3624	50,093304	-95,426186
1833	24-06-2021 13:02:40000	1256,1711	405,517914	1320,004	398,992828	230,35881	1912,2438	50,098427	-95,164185
1834	24-06-2021 13:02:45000	1265,2051	406,146881	1328,7961	398,422943	230,0298	1927,5537	50,08017	-95,214386
1835	24-06-2021 13:02:50000	1264,8929	393,643585	1324,73	398,740326	230,213028	1920,0634	50,044212	-95,483078
1836	24-06-2021 13:02:55000	1262,2614	405,654388	1325,8428	398,721771	230,202316	1921,7679	50,019829	-95,204445
1837	24-06-2021 13:03:00000	1255,8512	410,085022	1321,1101	399,216278	230,487823	1912,5938	50,031116	-95,060295
1838	24-06-2021 13:03:05000	1258,3584	393,54184	1318,4615	398,932007	230,3237	1910,0698	50,043156	-95,441414
1839	24-06-2021 13:03:10000	1250,0767	404,048004	1313,7527	399,280762	230,52504	1901,7253	50,074078	-95,153107
1840	24-06-2021 13:03:15000	1252,0568	408,277374	1316,942	399,022064	230,375671	1907,512	50,096367	-95,073029
1841	24-06-2021 13:03:20000	1265,6311	401,958191	1327,9279	398,356903	229,991653	1926,6558	50,054451	-95,308723
1842	24-06-2021 13:03:25000	1263,95	398,143463	1325,1746	398,638062	230,153992	1921,1046	50,009895	-95,379883
1843	24-06-2021 13:03:30000	1257,592	388,855225	1316,3383	398,87973	230,293518	1907,2341	50,014702	-95,537155
1844	24-06-2021 13:03:35000	1252,4603	403,066101	1315,7201	398,955444	230,337219	1906,0426	50,034401	-95,192009
1845	24-06-2021 13:03:40000	1256,2202	406,208679	1320,2632	399,263092	230,514847	1911,1133	50,059151	-95,149231
1846	24-06-2021 13:03:45000	1258,9971	402,163116	1321,6689	398,994751	230,359924	1914,4081	50,072807	-95,258125
1847	24-06-2021 13:03:50000	1255,0292	401,657013	1317,7355	398,978516	230,350555	1908,7885	50,078617	-95,241364
1848	24-06-2021 13:03:55000	1261,7299	400,570221	1323,7896	398,862213	230,283401	1918,0483	50,07011	-95,311966
1849	24-06-2021 13:04:00000	1254,7661	415,460419	1321,7585	398,985291	230,354462	1914,4886	50,067112	-94,93158
1850	24-06-2021 13:04:05000	1261,7972	393,102509	1321,6133	398,928925	230,321899	1914,7051	50,049191	-95,474007
1851	24-06-2021 13:04:10000	1272,1779	396,575409	1332,557	398,493469	230,070511	1932,5746	50,01347	-95,468918
1852	24-06-2021 13:04:15000	1261,4183	408,156189	1325,8085	398,555756	230,106476	1922,3806	49,993935	-95,143341
1853	24-06-2021 13:04:20000	1264,0168	402,847534	1326,6592	398,872986	230,289627	1922,1903	49,986778	-95,278183
1854	24-06-2021 13:04:25000	1253,0574	402,54422	1316,1287	399,161072	230,455948	1905,5698	50,005306	-95,207817
1855	24-06-2021 13:04:30000	1250,2697	399,437836	1312,5261	399,430847	230,61171	1899,085	50,047112	-95,256744
1856	24-06-2021 13:04:35000	1252,8523	407,772186	1317,5421	398,91394	230,313278	1908,7449	50,069778	-95,090118

1857	24-06-2021 13:04:40000	1258,313	398,21228	1319,8201	398,633423	230,151306	1913,347	50,062649	-95,339752
1858	24-06-2021 13:04:45000	1256,757	401,346191	1319,2865	399,070709	230,403778	1910,6971	50,075386	-95,260353
1859	24-06-2021 13:04:50000	1254,5697	399,369019	1316,6021	398,844604	230,273239	1907,8085	50,076351	-95,28846
1860	24-06-2021 13:04:55000	1268,0166	399,361481	1329,4193	398,169586	229,883514	1929,5878	50,033955	-95,381241
1861	24-06-2021 13:05:00000	1261,1837	400,151031	1323,1422	399,054199	230,394241	1916,27	50,024498	-95,317322
1862	24-06-2021 13:05:05000	1262,3577	403,36319	1325,2354	399,018372	230,373566	1919,4734	50,014854	-95,255356
1863	24-06-2021 13:05:10000	1254,3417	404,954468	1318,09	399,27124	230,519547	1907,9708	50,03273	-95,163589
1864	24-06-2021 13:05:15000	1254,5936	393,145233	1314,7504	399,226501	230,493744	1903,1967	50,066952	-95,424477
1865	24-06-2021 13:05:20000	1260,554	404,384338	1323,8289	399,089783	230,414795	1916,8734	50,072441	-95,220306
1866	24-06-2021 13:05:25000	1263,8726	397,536255	1324,9186	398,583893	230,122711	1921,0748	50,056419	-95,392479
1867	24-06-2021 13:05:30000	1264,4927	400,632782	1326,4419	398,55954	230,108658	1923,4945	50,026199	-95,329659
1868	24-06-2021 13:05:35000	1256,88	402,116791	1319,6383	398,87793	230,29248	1912,0273	50,030216	-95,244278
1869	24-06-2021 13:05:40000	1250,8121	402,67041	1314,0299	399,082306	230,410477	1902,9426	50,045368	-95,189018
1870	24-06-2021 13:05:45000	1251,4783	400,236298	1313,9204	398,812866	230,254913	1904,0684	50,071945	-95,247643
1871	24-06-2021 13:05:50000	1262,455	393,243195	1322,2832	398,303894	229,96106	1918,5756	50,058987	-95,475388
1872	24-06-2021 13:05:55000	1261,4806	405,807709	1325,1465	398,457855	230,049942	1922,0934	50,039799	-95,195557
1873	24-06-2021 13:06:00000	1264,1941	393,544708	1324,0333	398,730591	230,207413	1919,0972	50,025303	-95,480537
1874	24-06-2021 13:06:05000	1263,1787	401,097351	1325,3301	398,757904	230,22319	1920,8453	50,021637	-95,310509
1875	24-06-2021 13:06:10000	1256,4133	396,715118	1317,5574	399,008972	230,368134	1908,337	50,013912	-95,359291
1876	24-06-2021 13:06:15000	1248,5386	401,230499	1311,4247	399,087799	230,413635	1899,1471	50,042393	-95,204758
1877	24-06-2021 13:06:20000	1253,8011	405,735626	1317,8158	398,661743	230,167664	1910,4192	50,063736	-95,142357
1878	24-06-2021 13:06:25000	1265,3386	396,806061	1326,0984	398,162445	229,879395	1924,9747	50,037193	-95,418159
1879	24-06-2021 13:06:30000	1253,4948	402,412689	1316,5049	398,72229	230,202637	1908,1619	50,042774	-95,213837
1880	24-06-2021 13:06:35000	1241,7805	390,389069	1301,6998	399,497498	230,650192	1883,3217	50,100857	-95,396843
1881	24-06-2021 13:06:40000	1255,7681	405,76474	1319,6964	398,494507	230,071106	1914,0162	50,109081	-95,155838
1882	24-06-2021 13:06:45000	1275,8567	395,449829	1335,736	398,181274	229,890259	1938,785	50,045563	-95,51712
1883	24-06-2021 13:06:50000	1263,84	406,946747	1327,7413	398,812042	230,25444	1924,1891	50,031078	-95,18721
1884	24-06-2021 13:06:55000	1258,6509	401,770691	1321,2198	398,812653	230,254791	1914,7981	50,041016	-95,264305
1885	24-06-2021 13:07:00000	1264,1079	407,058624	1328,0306	398,585419	230,123596	1925,5874	50,03587	-95,186646
1886	24-06-2021 13:07:05000	1259,6752	405,535431	1323,3445	398,514313	230,08255	1919,1511	50,03281	-95,188759

1887	24-06-2021 13:07:10000	1257,5258	403,824188	1320,7745	398,780121	230,236023	1914,1521	50,041718	-95,211243
1888	24-06-2021 13:07:15000	1256,0488	398,287659	1317,6842	398,824585	230,261688	1909,588	50,063778	-95,322449
1889	24-06-2021 13:07:20000	1256,6025	398,964661	1318,4169	398,235718	229,921692	1913,5442	50,064781	-95,311485
1890	24-06-2021 13:07:25000	1266,8652	399,077728	1328,236	398,27887	229,946625	1927,3446	50,033524	-95,379539
1891	24-06-2021 13:07:30000	1257,0647	400,524292	1319,33	398,855255	230,279404	1911,7047	50,030735	-95,280548
1892	24-06-2021 13:07:35000	1258,3944	400,49472	1320,588	398,845337	230,273666	1913,604	50,043377	-95,290466
1893	24-06-2021 13:07:40000	1258,6143	401,446503	1321,0863	398,635529	230,152527	1915,3442	50,053551	-95,271156
1894	24-06-2021 13:07:45000	1259,1382	406,813995	1323,2258	398,605103	230,134949	1918,5579	50,046028	-95,156715
1895	24-06-2021 13:07:50000	1260,6797	392,311798	1320,3113	398,677582	230,176804	1914,071	50,039978	-95,483521
1896	24-06-2021 13:07:55000	1258,4812	405,894043	1322,318	398,532959	230,093307	1917,5649	50,05405	-95,172356
1897	24-06-2021 13:08:00000	1250,2738	395,014923	1311,1908	398,754181	230,221024	1900,548	50,085907	-95,354073
1898	24-06-2021 13:08:05000	1265,8156	404,807556	1328,9689	398,26947	229,941177	1928,5959	50,063618	-95,247948
1899	24-06-2021 13:08:10000	1253,231	391,702667	1313,0189	399,408539	230,598816	1900,0532	50,082287	-95,446526
1900	24-06-2021 13:08:15000	1251,5295	408,981781	1316,6595	399,178284	230,465881	1906,3188	50,11974	-95,053391
1901	24-06-2021 13:08:20000	1262,9465	394,112579	1323,0112	398,859558	230,281876	1917,0946	50,109879	-95,459999
1902	24-06-2021 13:08:25000	1270,235	391,662872	1329,2467	398,929718	230,322372	1925,7533	50,080235	-95,560516
1903	24-06-2021 13:08:30000	1260,2185	404,50351	1323,5459	399,374481	230,579163	1915,4606	50,080166	-95,215324
1904	24-06-2021 13:08:35000	1255,9777	402,350769	1318,8502	399,292877	230,532028	1909,1417	50,090237	-95,232773
1905	24-06-2021 13:08:40000	1255,9882	390,830322	1315,3914	399,331177	230,554153	1903,8131	50,110542	-95,483986
1906	24-06-2021 13:08:45000	1257,9426	396,881042	1319,0657	399,169098	230,460587	1909,9611	50,118862	-95,366188
1907	24-06-2021 13:08:50000	1263,3016	397,958374	1324,5005	398,99527	230,360214	1918,6381	50,095978	-95,379463
1908	24-06-2021 13:08:55000	1262,1299	404,613281	1325,3995	399,396973	230,592148	1918,0084	50,092472	-95,226379
1909	24-06-2021 13:09:00000	1259,1099	399,797821	1321,0586	399,362915	230,572479	1911,8849	50,086807	-95,310669
1910	24-06-2021 13:09:05000	1263,8969	400,881958	1325,9493	399,166748	230,459229	1919,8401	50,075962	-95,320152
1911	24-06-2021 13:09:10000	1271,198	399,790497	1332,5828	398,263702	229,937851	1933,8639	50,029625	-95,393547
1912	24-06-2021 13:09:15000	1262,1256	403,251953	1324,9803	398,788025	230,240555	1920,4176	50,003563	-95,256165
1913	24-06-2021 13:09:20000	1262,9479	398,910431	1324,4496	398,664429	230,169205	1920,2489	49,996662	-95,35643
1914	24-06-2021 13:09:25000	1254,787	401,009064	1317,3075	398,902985	230,306931	1908,6914	50,016357	-95,253929
1915	24-06-2021 13:09:30000	1255,3676	395,253052	1316,1204	399,022766	230,376083	1906,499	50,046791	-95,383949
1916	24-06-2021 13:09:35000	1252,0824	408,774078	1317,1206	398,924805	230,319519	1908,4913	50,062859	-95,062096

1917	24-06-2021 13:09:40000	1257,5972	391,852936	1317,2317	398,69931	230,189331	1909,6094	50,053013	-95,47274
1918	24-06-2021 13:09:45000	1265,9019	406,433838	1329,5471	398,534637	230,094254	1928,2144	50,033699	-95,212997
1919	24-06-2021 13:09:50000	1262,7867	401,130554	1324,9664	398,555847	230,106506	1921,4998	50,003315	-95,307076
1920	24-06-2021 13:09:55000	1258,0554	392,261536	1317,7908	398,650818	230,161346	1910,7134	50,008396	-95,46701
1921	24-06-2021 13:10:00000	1252,2118	406,18811	1316,4434	399,081604	230,410065	1906,5444	50,022259	-95,120827
1922	24-06-2021 13:10:05000	1252,3208	398,046051	1314,0579	398,711945	230,19664	1904,8605	50,061813	-95,301804
1923	24-06-2021 13:10:10000	1261,496	397,052917	1322,5065	398,451233	230,046097	1918,4341	50,064468	-95,386757
1924	24-06-2021 13:10:15000	1261,2787	400,589264	1323,3652	398,552307	230,104477	1919,1075	50,051609	-95,308434
1925	24-06-2021 13:10:20000	1258,9015	402,723846	1321,7487	398,646393	230,158783	1916,4514	50,048706	-95,245155
1926	24-06-2021 13:10:25000	1259,5569	401,154663	1321,8959	398,844116	230,272934	1915,5992	50,04528	-95,284126
1927	24-06-2021 13:10:30000	1250,8086	401,103485	1313,5471	399,090729	230,415314	1902,3965	50,065994	-95,223732
1928	24-06-2021 13:10:35000	1257,3676	395,511261	1318,1055	398,669128	230,171921	1911,0004	50,074562	-95,392021
1929	24-06-2021 13:10:40000	1254,5577	399,677246	1316,6841	398,865082	230,285034	1907,89	50,100475	-95,281601
1930	24-06-2021 13:10:45000	1268,3435	395,48764	1328,5729	398,377838	230,003754	1927,5276	50,064167	-95,466614
1931	24-06-2021 13:10:50000	1268,8893	402,74704	1331,2721	398,567902	230,11348	1930,4939	50,018772	-95,314049
1932	24-06-2021 13:10:55000	1256,718	402,07196	1319,4703	398,713898	230,197754	1912,7506	50,027565	-95,244125
1933	24-06-2021 13:11:00000	1258,248	395,500183	1318,9423	398,505829	230,077637	1912,9272	50,032269	-95,39827
1934	24-06-2021 13:11:05000	1263,5673	398,445679	1324,9005	398,169434	229,883423	1923,1393	50,018723	-95,370735
1935	24-06-2021 13:11:10000	1256,5459	399,93219	1318,6558	398,399994	230,016541	1913,0034	50,024429	-95,289902
1936	24-06-2021 13:11:15000	1252,4844	402,404816	1315,5406	398,177063	229,887817	1909,5416	50,052464	-95,206833
1937	24-06-2021 13:11:20000	1259,8578	402,104034	1322,4708	398,00708	229,789688	1920,5468	50,048359	-95,265442
1938	24-06-2021 13:11:25000	1255,7102	392,176819	1315,5267	398,373505	230,001236	1908,6013	50,049847	-95,453033
1939	24-06-2021 13:11:30000	1256,8483	403,058441	1319,8954	398,562897	230,11058	1914,0537	50,061085	-95,223328
1940	24-06-2021 13:11:35000	1247,4801	402,643433	1310,8502	399,0784	230,408218	1898,2881	50,089336	-95,165726
1941	24-06-2021 13:11:40000	1259,1549	407,170471	1323,3514	398,142731	229,867996	1920,9318	50,092472	-95,148949
1942	24-06-2021 13:11:45000	1271,0447	399,1185	1332,2351	397,7771	229,656921	1935,6106	50,047565	-95,406944
1943	24-06-2021 13:11:50000	1264,8672	389,943085	1323,6105	398,257233	229,934113	1920,861	50,009949	-95,56189
1944	24-06-2021 13:11:55000	1256,5221	412,042847	1322,3566	398,337952	229,980713	1918,5861	50,013176	-95,021423
1945	24-06-2021 13:12:00000	1248,5046	402,614197	1311,8163	398,910767	230,311417	1900,641	50,052246	-95,173737
1946	24-06-2021 13:12:05000	1248,1644	400,265625	1310,7734	398,647675	230,159515	1900,3508	50,093884	-95,223503

1947	24-06-2021 13:12:10000	1261,5516	398,617249	1323,03	398,141754	229,867432	1920,5798	50,078407	-95,353218
1948	24-06-2021 13:12:15000	1270,4294	396,060089	1330,7345	398,003326	229,787506	1932,3826	50,027519	-95,468285
1949	24-06-2021 13:12:20000	1265,5521	400,572876	1327,434	398,2164	229,910538	1926,6884	50,004078	-95,338242
1950	24-06-2021 13:12:25000	1254,5591	405,811768	1318,5604	398,484619	230,065399	1912,4921	50,025139	-95,146118
1951	24-06-2021 13:12:30000	1254,3185	407,165863	1318,749	398,264526	229,938324	1913,7382	50,043789	-95,114273
1952	24-06-2021 13:12:35000	1259,1672	389,582458	1318,0579	398,370056	229,999237	1912,2981	50,048439	-95,532013
1953	24-06-2021 13:12:40000	1254,4191	404,907776	1318,1492	398,314697	229,96727	1912,6367	50,062672	-95,165176
1954	24-06-2021 13:12:45000	1264,3292	399,969116	1326,0858	398,033844	229,80513	1925,5306	50,044506	-95,342941
1955	24-06-2021 13:12:50000	1260,7714	393,00238	1320,6041	398,520721	230,086227	1915,3324	50,037014	-95,469292
1956	24-06-2021 13:12:55000	1250,9385	404,172089	1314,611	398,771393	230,230942	1905,427	50,057827	-95,156548
1957	24-06-2021 13:13:00000	1260,2941	396,054993	1321,0604	398,200653	229,901443	1917,4557	50,05682	-95,400185
1958	24-06-2021 13:13:05000	1255,1416	395,634735	1316,0195	398,446869	230,043579	1909,0847	50,05212	-95,374092
1959	24-06-2021 13:13:10000	1256,1753	402,065857	1318,9517	398,594635	230,128906	1912,5514	50,060944	-95,24044
1960	24-06-2021 13:13:15000	1260,157	403,665161	1323,2313	398,039795	229,808548	1921,4376	50,066654	-95,233307
1961	24-06-2021 13:13:20000	1268,3812	395,929047	1328,7404	398,077942	229,830597	1929,1227	50,023956	-95,45742
1962	24-06-2021 13:13:25000	1267,665	392,534058	1327,0485	398,161163	229,878647	1926,2279	49,991714	-95,525146
1963	24-06-2021 13:13:30000	1258,3682	405,404022	1322,0602	398,717499	230,199829	1916,5035	49,999981	-95,182373
1964	24-06-2021 13:13:35000	1262,569	401,174133	1324,7721	398,148651	229,871429	1923,0162	49,996861	-95,304619
1965	24-06-2021 13:13:40000	1259,2954	406,939453	1323,4139	398,680908	230,178726	1918,537	49,996876	-95,15506
1966	24-06-2021 13:13:45000	1251,5313	393,6521	1311,9803	398,456726	230,049286	1902,9199	50,015095	-95,392532
1967	24-06-2021 13:13:50000	1260,6901	394,26178	1320,9019	398,277252	229,945663	1916,7911	50,010174	-95,441612
1968	24-06-2021 13:13:55000	1258,8312	401,81842	1321,4061	398,579956	230,120422	1916,0972	50,019432	-95,264526
1969	24-06-2021 13:14:00000	1257,288	404,151581	1320,6482	398,725311	230,204361	1914,3486	50,035179	-95,202339
1970	24-06-2021 13:14:05000	1253,4852	408,452728	1318,3545	398,842499	230,272003	1910,4781	50,059311	-95,079521
1971	24-06-2021 13:14:10000	1261,4988	388,750885	1320,0403	398,544495	230,09996	1914,2709	50,065483	-95,56517
1972	24-06-2021 13:14:15000	1261,1597	399,695892	1322,9816	398,629578	230,149063	1918,1831	50,055721	-95,327072
1973	24-06-2021 13:14:20000	1264,2074	390,976624	1323,2849	398,409515	230,022018	1919,6948	50,035934	-95,535538
1974	24-06-2021 13:14:25000	1264,7878	397,631805	1325,8203	398,555545	230,106293	1922,6439	50,007133	-95,396629
1975	24-06-2021 13:14:30000	1260,2461	403,263489	1323,1937	398,754425	230,221161	1917,9092	50,005009	-95,242752
1976	24-06-2021 13:14:35000	1260,3024	403,971649	1323,4634	398,469299	230,056549	1919,657	50,007828	-95,2276

1977	24-06-2021 13:14:40000	1254,8521	399,398682	1316,88	398,742157	230,214066	1908,748	50,022175	-95,28978
1978	24-06-2021 13:14:45000	1263,007	401,810913	1325,3824	398,459503	230,050903	1922,3741	50,006645	-95,293777
1979	24-06-2021 13:14:50000	1259,1639	403,503845	1322,2365	398,299805	229,958694	1918,5682	49,999866	-95,229866
1980	24-06-2021 13:14:55000	1254,4756	398,91626	1316,3751	398,861206	230,282822	1907,3114	50,012833	-95,297737
1981	24-06-2021 13:15:00000	1249,3737	399,056915	1311,5568	398,728363	230,206116	1901,0729	50,040367	-95,258835
1982	24-06-2021 13:15:05000	1256,2446	400,223785	1318,4573	398,750214	230,218719	1911,0043	50,055603	-95,281403
1983	24-06-2021 13:15:10000	1258,9501	400,889771	1321,2372	398,466583	230,054977	1916,2924	50,056076	-95,28569
1984	24-06-2021 13:15:15000	1267,0477	407,660797	1331,0137	398,451904	230,046509	1930,4097	50,029594	-95,194199
1985	24-06-2021 13:15:20000	1270,2057	394,835022	1330,1567	398,324768	229,973129	1929,7911	49,981079	-95,492928
1986	24-06-2021 13:15:25000	1260,5026	407,084137	1324,6071	398,600037	230,132034	1920,6046	49,962395	-95,160477
1987	24-06-2021 13:15:30000	1251,4175	398,185577	1313,2394	398,638092	230,153992	1903,9789	49,986847	-95,292419
1988	24-06-2021 13:15:35000	1247,5822	403,819275	1311,3091	398,895538	230,302628	1899,7583	50,039886	-95,140213
1989	24-06-2021 13:15:40000	1259,3711	404,383728	1322,7024	398,186035	229,893005	1919,7367	50,056	-95,211975
1990	24-06-2021 13:15:45000	1267,6876	398,770142	1328,928	397,871216	229,711258	1930,223	50,023224	-95,391747
1991	24-06-2021 13:15:50000	1265,5653	396,345917	1326,1771	398,223724	229,914764	1924,5588	49,987606	-95,429588
1992	24-06-2021 13:15:55000	1261,9102	404,221863	1325,0707	398,467499	230,055511	1921,7692	49,971661	-95,233414
1993	24-06-2021 13:16:00000	1258,2605	397,260773	1319,483	398,570038	230,114731	1913,2115	49,967293	-95,360107
1994	24-06-2021 13:16:05000	1260,6273	397,959747	1321,9504	398,077545	229,830368	1919,084	49,964378	-95,36116
1995	24-06-2021 13:16:10000	1254,7087	396,937195	1315,9989	398,268005	229,940338	1909,6029	49,971107	-95,34269
1996	24-06-2021 13:16:15000	1254,3829	399,290405	1316,4	398,193573	229,897354	1910,5701	49,975567	-95,288879
1997	24-06-2021 13:16:20000	1250,245	397,180389	1311,8174	398,378662	230,004227	1903,0295	50,008858	-95,306328
1998	24-06-2021 13:16:25000	1253,6134	397,506561	1315,1266	398,165863	229,881363	1908,8317	50,02935	-95,322639
1999	24-06-2021 13:16:30000	1252,7932	403,998016	1316,3226	398,499512	230,07399	1909,0912	50,049168	-95,173721
2000	24-06-2021 13:16:35000	1257,342	397,724365	1318,7471	398,229279	229,917984	1913,7806	50,060448	-95,343689
2001	24-06-2021 13:16:40000	1261,924	406,068817	1325,6486	398,274078	229,943848	1923,5594	50,04443	-95,192955
2002	24-06-2021 13:16:45000	1265,652	402,828705	1328,2115	398,45163	230,046356	1926,4377	50,016621	-95,28994
2003	24-06-2021 13:16:50000	1256,7261	395,232269	1317,4099	398,703094	230,191528	1909,645	50,020531	-95,3937
2004	24-06-2021 13:16:55000	1255,0566	400,748077	1317,4849	398,649536	230,160614	1909,9672	50,038216	-95,261566
2005	24-06-2021 13:17:00000	1263,9561	409,439606	1328,6178	398,235687	229,921677	1928,0948	50,020832	-95,133141
2006	24-06-2021 13:17:05000	1257,1251	402,057007	1319,8535	398,231812	229,919418	1915,4858	50,021534	-95,247322



2007	24-06-2021 13:17:10000	1261,9961	398,151459	1323,3135	397,988983	229,779236	1921,6555	50,012901	-95,366371
2008	24-06-2021 13:17:15000	1263,2325	394,793671	1323,4872	398,108856	229,84845	1921,235	49,98959	-95,447281
2009	24-06-2021 13:17:20000	1259,5316	409,91684	1324,5573	398,146423	229,870132	1922,6058	49,98843	-95,090767
2010	24-06-2021 13:17:25000	1259,402	399,524841	1321,2544	398,160492	229,878265	1917,7775	49,984566	-95,318649
2011	24-06-2021 13:17:30000	1256,9581	403,294373	1320,072	397,952576	229,758224	1917,0511	49,983524	-95,21891
2012	24-06-2021 13:17:35000	1258,4521	395,7388	1319,2085	398,374939	230,00209	1913,7206	49,977177	-95,394485
2013	24-06-2021 13:17:40000	1244,4802	402,836151	1308,0551	398,737457	230,211349	1895,9838	50,031246	-95,139748
2014	24-06-2021 13:17:45000	1246,6917	401,427826	1309,7268	398,665497	230,169815	1898,7838	50,078823	-95,187149
2015	24-06-2021 13:17:50000	1259,4214	405,555176	1323,1089	398,165344	229,881042	1920,3441	50,078602	-95,186523
2016	24-06-2021 13:17:55000	1260,014	395,167633	1320,5276	398,238312	229,923187	1916,2373	50,059448	-95,41748
2017	24-06-2021 13:18:00000	1259,5988	401,357574	1321,9973	398,854828	230,279129	1915,5408	50,054981	-95,279976
2018	24-06-2021 13:18:05000	1259,1691	404,296265	1322,4834	398,838318	230,269592	1916,2662	50,055447	-95,212471
2019	24-06-2021 13:18:10000	1263,0968	400,10434	1324,9517	398,765015	230,227295	1920,2373	50,047577	-95,331535
2020	24-06-2021 13:18:15000	1252,6995	404,573364	1316,41	398,921509	230,317642	1907,1713	50,067776	-95,160271
2021	24-06-2021 13:18:20000	1252,52	403,91687	1316,0377	398,720978	230,201843	1907,5613	50,091537	-95,173569
2022	24-06-2021 13:18:25000	1265,2426	392,240143	1324,6475	398,441956	230,040756	1921,3177	50,077248	-95,515411
2023	24-06-2021 13:18:30000	1260,7495	400,722107	1322,9011	398,501404	230,075073	1918,5439	50,066906	-95,301865
2024	24-06-2021 13:18:35000	1260,8531	399,811707	1322,7245	398,335236	229,979141	1919,0122	50,054012	-95,322433
2025	24-06-2021 13:18:40000	1276,9781	408,633667	1340,7665	397,411499	229,445831	1949,6503	49,98735	-95,242401
2026	24-06-2021 13:18:45000	1273,3295	392,265747	1332,3815	397,739288	229,635086	1935,941	49,92556	-95,56794
2027	24-06-2021 13:18:50000	1253,3939	403,846771	1316,8479	398,206512	229,904831	1911,101	49,946476	-95,181366
2028	24-06-2021 13:18:55000	1261,0476	409,378235	1325,8324	397,873718	229,712677	1925,7478	49,941807	-95,113647
2029	24-06-2021 13:19:00000	1254,8726	404,960968	1318,5972	398,085175	229,834763	1914,2316	49,957397	-95,167244
2030	24-06-2021 13:19:05000	1251,6172	400,746674	1314,2084	398,228607	229,917587	1907,176	49,977512	-95,23735
2031	24-06-2021 13:19:10000	1255,2325	401,905884	1318,0049	397,774445	229,655365	1914,8516	49,990562	-95,237312
2032	24-06-2021 13:19:15000	1258,5447	398,31311	1320,0712	397,703827	229,614609	1918,0981	49,997105	-95,339149
2033	24-06-2021 13:19:20000	1262,3715	398,172699	1323,6779	398,105255	229,846375	1921,4089	49,97699	-95,368477
2034	24-06-2021 13:19:25000	1252,3518	408,563568	1317,3114	398,350616	229,988037	1910,9977	50,008965	-95,068779
2035	24-06-2021 13:19:30000	1255,2798	395,374084	1316,073	398,069702	229,825851	1910,6088	50,02845	-95,380714
2036	24-06-2021 13:19:35000	1251,7755	402,655029	1314,9421	398,431091	230,0345	1907,2522	50,055534	-95,196236

2037	24-06-2021 13:19:40000	1265,7617	402,146423	1328,1094	397,706696	229,616272	1929,7664	50,029968	-95,305534
2038	24-06-2021 13:19:45000	1265,0476	390,901337	1324,0654	397,832336	229,688812	1923,3394	50,001171	-95,542679
2039	24-06-2021 13:19:50000	1262,3772	408,543701	1326,8398	397,986481	229,777802	1926,6251	49,994289	-95,14164
2040	24-06-2021 13:19:55000	1262,4192	413,749725	1328,4919	397,281464	229,370773	1932,3811	49,984035	-95,026474
2041	24-06-2021 13:20:00000	1259,4139	405,833466	1323,1871	398,185089	229,892456	1920,3588	49,9869	-95,180336
2042	24-06-2021 13:20:05000	1261,1062	392,204254	1320,6865	397,985077	229,776993	1917,6418	49,980965	-95,488686
2043	24-06-2021 13:20:10000	1261,119	399,373962	1322,8456	397,901337	229,728638	1921,2993	49,962898	-95,333794
2044	24-06-2021 13:20:15000	1252,3129	409,685699	1317,6228	397,988068	229,778717	1913,2476	49,981068	-95,04335
2045	24-06-2021 13:20:20000	1264,0807	401,018738	1326,1659	397,379272	229,427246	1928,6124	49,957211	-95,318443
2046	24-06-2021 13:20:25000	1259,269	392,32019	1318,9669	397,870117	229,710617	1915,6543	49,952534	-95,473892
2047	24-06-2021 13:20:30000	1260,3514	400,415985	1322,4291	397,843109	229,695023	1920,9193	49,940372	-95,305786
2048	24-06-2021 13:20:35000	1253,4622	402,57785	1316,5243	398,062866	229,821899	1911,3108	49,959995	-95,209953
2049	24-06-2021 13:20:40000	1254,678	400,998962	1317,2004	398,865631	230,285385	1909,275	49,985123	-95,25338
2050	24-06-2021 13:20:45000	1258,7659	395,871826	1319,5476	398,760529	230,224701	1913,2249	49,992588	-95,393738
2051	24-06-2021 13:20:50000	1253,1857	395,059265	1313,9811	398,804749	230,250229	1904,9523	50,001286	-95,373192
2052	24-06-2021 13:20:55000	1256,1584	392,366852	1316,0112	398,875397	230,291016	1907,5421	50,002174	-95,45195
2053	24-06-2021 13:21:00000	1256,2736	398,217987	1317,8774	398,83725	230,268997	1910,3561	50,003017	-95,325523
2054	24-06-2021 13:21:05000	1257,6804	396,164032	1318,5999	398,720917	230,201828	1911,9928	50,002979	-95,379982
2055	24-06-2021 13:21:10000	1258,3505	391,100677	1317,7275	398,995667	230,360474	1909,3696	50,006485	-95,493988
2056	24-06-2021 13:21:15000	1254,4672	397,555237	1315,9551	399,117249	230,430634	1906,2245	50,021725	-95,327499
2057	24-06-2021 13:21:20000	1256,17	398,5578	1317,8815	398,711395	230,196335	1910,9698	50,0303	-95,317375
2058	24-06-2021 13:21:25000	1255,8854	394,838745	1316,49	399,100525	230,42099	1907,1757	50,03952	-95,396507
2059	24-06-2021 13:21:30000	1251,5361	399,957794	1313,8909	399,25824	230,512039	1902,6093	50,056953	-95,254204
2060	24-06-2021 13:21:35000	1267,3218	400,561707	1329,1178	398,473328	230,058884	1928,5022	50,020676	-95,350594
2061	24-06-2021 13:21:40000	1261,2437	397,735016	1322,4706	399,049225	230,391388	1916,1232	50,005272	-95,370255
2062	24-06-2021 13:21:45000	1254,3689	394,653961	1314,9878	399,25415	230,509689	1904,2921	50,012585	-95,390152
2063	24-06-2021 13:21:50000	1258,5941	387,27652	1316,8304	398,880707	230,294083	1908,7659	50,018364	-95,577545
2064	24-06-2021 13:21:55000	1265,7433	385,489166	1323,1432	398,250244	229,930084	1920,822	49,993198	-95,66185
2065	24-06-2021 13:22:00000	1270,1947	392,3927	1329,4233	398,159729	229,877838	1930,359	49,945736	-95,544785
2066	24-06-2021 13:22:05000	1259,2826	400,041321	1321,297	399,069946	230,403336	1914,2909	49,940876	-95,306549

2067	24-06-2021 13:22:10000	1246,436	399,228729	1308,811	399,271698	230,519806	1895,2526	49,981701	-95,234222
2068	24-06-2021 13:22:15000	1257,198	397,660828	1318,5905	399,008514	230,367874	1910,6287	49,999611	-95,344078
2069	24-06-2021 13:22:20000	1256,9724	399,652618	1318,9775	398,639923	230,15506	1912,9547	49,989464	-95,298996
2070	24-06-2021 13:22:25000	1269,4698	384,940552	1326,5493	398,391235	230,01149	1925,1914	49,957161	-95,697151
2071	24-06-2021 13:22:30000	1261,6394	391,930054	1321,1144	398,910645	230,311371	1914,8525	49,940422	-95,498123
2072	24-06-2021 13:22:35000	1258,0261	397,828674	1319,4307	399,139893	230,443726	1911,3334	49,936596	-95,34613
2073	24-06-2021 13:22:40000	1250,6877	400,388611	1313,2139	399,166321	230,458984	1902,1481	49,953613	-95,238686
2074	24-06-2021 13:22:45000	1247,292	403,271301	1310,8643	399,32428	230,550171	1897,9723	49,997162	-95,15036
2075	24-06-2021 13:22:50000	1246,6827	392,444855	1306,993	399,276489	230,522583	1892,5475	50,0425	-95,385567
2076	24-06-2021 13:22:55000	1259,877	393,072357	1319,7711	398,752472	230,220032	1913,5992	50,046253	-95,461777
2077	24-06-2021 13:23:00000	1264,5953	396,055695	1325,1648	398,643768	230,157288	1922,0077	50,016251	-95,429298
2078	24-06-2021 13:23:05000	1265,4795	398,707977	1326,803	398,824066	230,261383	1923,5784	49,990562	-95,378098
2079	24-06-2021 13:23:10000	1258,0586	390,94635	1317,403	399,066406	230,401291	1908,7554	49,984905	-95,495354
2080	24-06-2021 13:23:15000	1256,0507	401,509827	1318,6636	399,381134	230,583008	1909,1119	50,003395	-95,251793
2081	24-06-2021 13:23:20000	1260,2084	403,563019	1323,2491	398,774597	230,232803	1918,4783	50,000957	-95,235909
2082	24-06-2021 13:23:25000	1254,2153	393,759613	1314,5732	399,370117	230,576645	1903,1123	50,019207	-95,408554
2083	24-06-2021 13:23:30000	1256,2372	403,72113	1319,516	399,135559	230,441223	1911,3536	50,021458	-95,204384
2084	24-06-2021 13:23:35000	1259,3185	387,648926	1317,6322	398,90274	230,306808	1909,7892	50,013721	-95,574348
2085	24-06-2021 13:23:40000	1270,3444	396,079681	1330,6592	398,553741	230,105301	1930,3148	49,986134	-95,4673
2086	24-06-2021 13:23:45000	1263,2201	393,178314	1322,9944	398,81134	230,254044	1918,0756	49,967514	-95,481895
2087	24-06-2021 13:23:50000	1250,7738	385,424408	1308,8113	400,117157	231,007965	1891,2717	49,99226	-95,565628
2088	24-06-2021 13:23:55000	1246,2228	405,709412	1310,5997	399,651031	230,738815	1896,0066	50,037518	-95,087982
2089	24-06-2021 13:24:00000	1258,3	399,651978	1320,2427	399,119446	230,431915	1912,6892	50,021832	-95,308243
2090	24-06-2021 13:24:05000	1254,0608	389,76004	1313,2333	399,770508	230,8078	1899,4052	50,037846	-95,494148
2091	24-06-2021 13:24:10000	1249,6888	397,237823	1311,3047	399,886261	230,874649	1895,9957	50,075588	-95,301178
2092	24-06-2021 13:24:15000	1257,8203	402,783569	1320,7371	399,469391	230,633972	1911,587	50,075932	-95,236237
2093	24-06-2021 13:24:20000	1273,7067	380,560944	1329,3439	398,877808	230,292404	1926,8754	50,034325	-95,814682
2094	24-06-2021 13:24:25000	1264,8005	405,756683	1328,2916	399,126312	230,435883	1924,1561	50,003487	-95,220085
2095	24-06-2021 13:24:30000	1254,0306	391,801727	1313,8119	399,639893	230,732391	1900,8198	50,011791	-95,449791
2096	24-06-2021 13:24:35000	1251,9453	393,844574	1312,4331	399,591675	230,704559	1899,078	50,035542	-95,391174

2097	24-06-2021 13:24:40000	1247,8208	394,977692	1308,8407	399,815491	230,833771	1892,7644	50,061726	-95,33786
2098	24-06-2021 13:24:45000	1257,6947	395,570007	1318,4352	399,469513	230,634033	1908,2417	50,071556	-95,392982
2099	24-06-2021 13:24:50000	1255,973	395,104065	1316,6531	399,179199	230,466415	1907,0344	50,06694	-95,391335
2100	24-06-2021 13:24:55000	1263,8514	402,200134	1326,3052	399,132568	230,439499	1921,1951	50,045979	-95,291145
2101	24-06-2021 13:25:00000	1261,837	402,572723	1324,4989	398,953613	230,336151	1919,4905	50,019566	-95,269005
2102	24-06-2021 13:25:05000	1271,1578	394,584747	1330,9918	398,135651	229,863922	1932,8696	49,954899	-95,504555
2103	24-06-2021 13:25:10000	1265,8909	392,231934	1325,2644	398,923859	230,319	1920,8173	49,925598	-95,519875
2104	24-06-2021 13:25:15000	1249,2495	396,01889	1310,5171	399,268982	230,51825	1897,7472	49,956558	-95,324921
2105	24-06-2021 13:25:20000	1251,7273	401,077301	1314,4141	399,13327	230,439896	1904,0532	49,984993	-95,23082
2106	24-06-2021 13:25:25000	1261,3356	389,853851	1320,2095	398,6297	230,14917	1914,8638	49,993732	-95,54055
2107	24-06-2021 13:25:30000	1253,5807	406,134491	1317,7289	399,300995	230,536743	1908,0271	49,988773	-95,131905
2108	24-06-2021 13:25:35000	1261,0896	389,291504	1319,8086	398,781799	230,236984	1913,517	49,981422	-95,550941
2109	24-06-2021 13:25:40000	1253,4946	402,662354	1316,5811	399,372559	230,578033	1906,125	49,986748	-95,208313
2110	24-06-2021 13:25:45000	1257,4923	397,436646	1318,8036	399,260681	230,513474	1909,7544	49,994408	-95,350998
2111	24-06-2021 13:25:50000	1245,2983	398,06131	1307,3717	399,635101	230,72963	1891,4854	50,034073	-95,252052
2112	24-06-2021 13:25:55000	1247,521	401,464905	1310,5276	399,087524	230,413483	1898,6456	50,067272	-95,192268
2113	24-06-2021 13:26:00000	1262,1019	392,958954	1321,8615	398,762787	230,225998	1916,7966	50,04422	-95,479134
2114	24-06-2021 13:26:05000	1266,9844	396,161072	1327,4762	398,779022	230,235382	1924,6823	50,009026	-95,4431
2115	24-06-2021 13:26:10000	1253,5433	404,854614	1317,2997	399,193573	230,474716	1908,0719	50,015701	-95,16008
2116	24-06-2021 13:26:15000	1255,1517	405,333008	1318,9772	398,416046	230,025803	1913,6141	50,034649	-95,160995
2117	24-06-2021 13:26:20000	1251,3278	403,015076	1314,6262	398,071747	229,827011	1908,6086	50,050591	-95,185051
2118	24-06-2021 13:26:25000	1256,2111	397,313477	1317,5448	397,727844	229,628464	1914,4305	50,062435	-95,344849
2119	24-06-2021 13:26:30000	1258,9646	402,340668	1321,692	397,817169	229,680023	1920,0812	50,074532	-95,254005
2120	24-06-2021 13:26:35000	1264,1851	407,600555	1328,2704	397,368805	229,421173	1931,7717	50,046974	-95,175285
2121	24-06-2021 13:26:40000	1267,6135	397,898529	1328,5959	397,584991	229,54599	1931,2671	50,010231	-95,410011
2122	24-06-2021 13:26:45000	1251,299	407,961914	1316,1239	397,910278	229,73378	1911,667	50,022331	-95,074562
2123	24-06-2021 13:26:50000	1260,3364	402,992432	1323,1973	397,693329	229,608536	1922,9271	50,017025	-95,249329
2124	24-06-2021 13:26:55000	1256,9963	402,855865	1319,9745	397,461456	229,47467	1919,2612	50,018375	-95,228836
2125	24-06-2021 13:27:00000	1261,3776	402,486786	1324,0352	397,288147	229,374603	1926,0909	49,99823	-95,267685
2126	24-06-2021 13:27:05000	1260,1963	396,80719	1321,1929	397,61264	229,561951	1920,3303	49,989887	-95,383217

2127	24-06-2021 13:27:10000	1248,7312	416,541138	1316,3723	397,756775	229,645157	1912,6881	50,013046	-94,861549
2128	24-06-2021 13:27:15000	1254,5586	400,008179	1316,7855	397,588531	229,548035	1914,0743	50,030766	-95,274338
2129	24-06-2021 13:27:20000	1261,134	403,354248	1324,0671	397,256134	229,35611	1926,3068	50,02356	-95,246986
2130	24-06-2021 13:27:25000	1261,0463	406,682281	1325,0012	397,709015	229,617584	1925,45	50,017048	-95,173218
2131	24-06-2021 13:27:30000	1250,6118	407,865387	1315,4406	397,825348	229,684738	1911,3042	50,032829	-95,071701
2132	24-06-2021 13:27:35000	1251,5342	396,239899	1312,762	398,014709	229,794067	1906,2972	50,066574	-95,33596
2133	24-06-2021 13:27:40000	1256,5098	409,872009	1321,67	397,674713	229,597794	1920,8185	50,068871	-95,069847
2134	24-06-2021 13:27:45000	1262,8889	399,103699	1324,4517	397,373322	229,423767	1926,2649	50,042603	-95,35183
2135	24-06-2021 13:27:50000	1259,0404	400,156891	1321,1012	397,579681	229,542908	1920,4702	50,028362	-95,302345
2136	24-06-2021 13:27:55000	1257,238	401,161438	1319,6886	397,96579	229,765839	1916,5657	50,026955	-95,267784
2137	24-06-2021 13:28:00000	1250,0999	404,687042	1313,9716	398,08902	229,836975	1907,6658	50,048168	-95,139038
2138	24-06-2021 13:28:05000	1258,9839	407,915405	1323,4181	397,508942	229,502075	1924,3225	50,040897	-95,131226
2139	24-06-2021 13:28:10000	1261,7719	412,040039	1327,3452	397,388184	229,432343	1930,3656	50,025513	-95,059814
2140	24-06-2021 13:28:15000	1263,5453	396,933533	1324,4255	397,277008	229,368179	1926,6237	50,010277	-95,403275
2141	24-06-2021 13:28:20000	1256,0186	403,861755	1319,351	397,534637	229,516907	1918,0835	50,010052	-95,19973
2142	24-06-2021 13:28:25000	1257,8402	412,195374	1323,6567	397,587738	229,547577	1924,0885	50,013435	-95,027679
2143	24-06-2021 13:28:30000	1257,458	401,246918	1319,9242	397,504089	229,499268	1919,0327	50,000114	-95,267448
2144	24-06-2021 13:28:35000	1252,2323	402,805511	1315,4231	398,060791	229,820679	1909,8552	50,029865	-95,196159
2145	24-06-2021 13:28:40000	1251,297	408,556	1316,3064	397,988953	229,779205	1911,4316	50,06395	-95,061234
2146	24-06-2021 13:28:45000	1267,9531	407,506836	1331,8284	397,127991	229,282135	1938,1404	50,038677	-95,203941
2147	24-06-2021 13:28:50000	1265,58	406,184387	1329,1644	397,368713	229,421112	1933,0573	50,017387	-95,216202
2148	24-06-2021 13:28:55000	1256,7876	410,779022	1322,2157	398,018555	229,796295	1919,7889	50,029354	-95,051628
2149	24-06-2021 13:29:00000	1256,9659	407,583405	1321,396	397,692627	229,608124	1920,2831	50,05196	-95,124084
2150	24-06-2021 13:29:05000	1262,9547	405,96579	1326,5983	397,620941	229,566727	1928,0825	50,04565	-95,202507
2151	24-06-2021 13:29:10000	1260,7257	395,471344	1321,2975	397,544434	229,522568	1920,6772	50,038589	-95,415741
2152	24-06-2021 13:29:15000	1257,599	408,116455	1322,1627	397,732819	229,631332	1921,1235	50,030781	-95,116806
2153	24-06-2021 13:29:20000	1257,2394	394,114594	1317,5649	397,535736	229,517548	1915,3519	50,032768	-95,42144
2154	24-06-2021 13:29:25000	1253,5248	409,333221	1318,6653	397,70166	229,613342	1916,1182	50,049694	-95,06012
2155	24-06-2021 13:29:30000	1256,7131	399,263336	1318,6125	397,698669	229,611633	1916,1509	50,052299	-95,305717
2156	24-06-2021 13:29:35000	1255,9148	410,594788	1321,329	397,903717	229,730011	1918,9277	50,047607	-95,04937

2157	24-06-2021 13:29:40000	1256,3416	402,438446	1319,2236	397,680756	229,601273	1916,9673	50,057159	-95,233406
2158	24-06-2021 13:29:45000	1262,6757	402,670593	1325,3276	397,592621	229,550385	1926,3104	50,042896	-95,272713
2159	24-06-2021 13:29:50000	1261,077	399,954651	1322,9811	397,556885	229,52977	1923,23	50,020367	-95,320862
2160	24-06-2021 13:29:55000	1265,3296	408,327637	1329,5828	397,405945	229,442612	1933,4053	49,98875	-95,167419
2161	24-06-2021 13:30:00000	1256,5574	406,116699	1320,5557	397,759277	229,646606	1918,7456	49,998165	-95,153687
2162	24-06-2021 13:30:05000	1253,5565	403,766846	1316,9783	397,783813	229,660782	1913,2874	50,005775	-95,184303
2163	24-06-2021 13:30:10000	1252,2485	408,743408	1317,2689	397,744904	229,638306	1913,936	50,025326	-95,063995
2164	24-06-2021 13:30:15000	1253,0774	404,835938	1316,8503	397,641602	229,578674	1913,8226	50,044647	-95,15715
2165	24-06-2021 13:30:20000	1261,0775	408,117035	1325,472	397,480713	229,485794	1927,1209	50,043369	-95,141769
2166	24-06-2021 13:30:25000	1251,8992	401,529602	1314,7158	398,06488	229,823059	1908,6508	50,05294	-95,222038
2167	24-06-2021 13:30:30000	1255,1881	401,014404	1317,691	397,858521	229,703918	1914,0176	50,06889	-95,25663
2168	24-06-2021 13:30:35000	1258,5702	407,118713	1322,7792	397,859619	229,704544	1921,4532	50,074333	-95,145905
2169	24-06-2021 13:30:40000	1259,0343	401,248322	1321,4264	397,642853	229,579391	1920,465	50,054443	-95,278435
2170	24-06-2021 13:30:45000	1253,3868	402,753876	1316,5066	398,30545	229,961945	1910,1392	50,069462	-95,205521
2171	24-06-2021 13:30:50000	1251,8168	407,564728	1316,4932	398,442261	230,040924	1909,3999	50,102776	-95,087219
2172	24-06-2021 13:30:55000	1264,7822	405,873718	1328,3099	397,44928	229,467636	1931,2914	50,088531	-95,2174
2173	24-06-2021 13:31:00000	1264,4446	406,530487	1328,1895	397,879272	229,715897	1929,1389	50,058498	-95,200623
2174	24-06-2021 13:31:05000	1254,5837	406,01239	1318,6458	398,279022	229,946686	1913,2773	50,049568	-95,141838
2175	24-06-2021 13:31:10000	1255,5543	399,963135	1317,7205	397,966034	229,765991	1913,5087	50,055786	-95,282295
2176	24-06-2021 13:31:15000	1264,1729	406,456909	1327,9083	397,716278	229,62178	1929,4207	50,042419	-95,200317
2177	24-06-2021 13:31:20000	1263,791	399,768433	1325,5122	397,431549	229,457397	1927,3318	50,029449	-95,343597
2178	24-06-2021 13:31:25000	1260,335	394,493927	1320,6323	397,915375	229,73674	1917,9561	50,017921	-95,434204
2179	24-06-2021 13:31:30000	1253,3503	406,992218	1317,7745	397,832642	229,68898	1914,2288	50,041798	-95,111137
2180	24-06-2021 13:31:35000	1253,906	407,871735	1318,5748	397,439728	229,462112	1917,2908	50,048111	-95,095551
2181	24-06-2021 13:31:40000	1261,7268	396,05011	1322,4259	397,293152	229,377487	1923,605	50,049129	-95,410019
2182	24-06-2021 13:31:45000	1252,4365	408,928009	1317,505	397,815338	229,67897	1913,9008	50,064968	-95,061234
2183	24-06-2021 13:31:50000	1255,2755	393,103729	1315,3887	397,648499	229,582642	1911,8124	50,083107	-95,430016
2184	24-06-2021 13:31:55000	1260,6501	400,062256	1322,6067	397,923218	229,741272	1920,8032	50,080235	-95,315567
2185	24-06-2021 13:32:00000	1257,2374	404,97464	1320,8522	398,008545	229,790527	1917,8856	50,09679	-95,183815
2186	24-06-2021 13:32:05000	1265,1027	403,278961	1327,8247	397,642578	229,579239	1929,7233	50,080158	-95,276321

2187	24-06-2021 13:32:10000	1260,3141	402,534363	1323,0365	397,928131	229,744095	1921,4543	50,073429	-95,259209
2188	24-06-2021 13:32:15000	1262,2336	406,514038	1326,0797	397,919312	229,738998	1925,8912	50,05209	-95,185349
2189	24-06-2021 13:32:20000	1259,5208	406,468475	1323,4838	398,233551	229,920441	1920,7428	50,04882	-95,167076
2190	24-06-2021 13:32:25000	1252,9517	400,504517	1315,4055	397,981293	229,774796	1910,0959	50,070885	-95,252121
2191	24-06-2021 13:32:30000	1260,9578	400,945068	1323,1674	397,816498	229,679657	1922,2235	50,064857	-95,298447
2192	24-06-2021 13:32:35000	1260,6582	406,117584	1324,4586	397,677124	229,599197	1924,6598	50,053143	-95,182907
2193	24-06-2021 13:32:40000	1260,7852	405,809509	1324,485	397,6362	229,575546	1924,9707	50,042065	-95,190598
2194	24-06-2021 13:32:45000	1266,3972	402,300171	1328,7616	397,369385	229,421524	1932,5198	50,01857	-95,30658
2195	24-06-2021 13:32:50000	1254,6821	404,645905	1318,3192	397,756226	229,644836	1915,4304	50,020439	-95,172859
2196	24-06-2021 13:32:55000	1252,8145	406,832581	1317,2156	397,992218	229,781113	1912,7833	50,041222	-95,110817
2197	24-06-2021 13:33:00000	1250,9851	398,214264	1312,8361	398,160339	229,878174	1905,5577	50,073746	-95,288757
2198	24-06-2021 13:33:05000	1252,1316	412,015564	1318,177	397,671112	229,595703	1915,7078	50,089119	-94,989647
2199	24-06-2021 13:33:10000	1263,8651	396,668732	1324,6512	397,586853	229,547073	1925,4194	50,074322	-95,411156
2200	24-06-2021 13:33:15000	1268,5939	403,546387	1331,2325	397,698212	229,611359	1934,4354	50,050854	-95,294685
2201	24-06-2021 13:33:20000	1261,7838	413,170563	1327,7079	397,731537	229,6306	1929,1923	50,02734	-95,034744
2202	24-06-2021 13:33:25000	1251,1078	401,72467	1314,0219	398,018921	229,796524	1907,8864	50,043568	-95,212097
2203	24-06-2021 13:33:30000	1253,3951	393,373718	1313,675	397,971113	229,768921	1907,6182	50,072205	-95,411346
2204	24-06-2021 13:33:35000	1254,0645	406,351746	1318,2562	397,71344	229,620148	1915,5607	50,097782	-95,130554
2205	24-06-2021 13:33:40000	1255,767	406,130585	1319,8079	397,595093	229,551834	1918,2632	50,103775	-95,147713
2206	24-06-2021 13:33:45000	1266,7517	400,755707	1328,6327	397,230988	229,341614	1932,927	50,084167	-95,342499
2207	24-06-2021 13:33:50000	1267,8516	405,615753	1331,1543	397,325317	229,396072	1936,1376	50,050858	-95,244522
2208	24-06-2021 13:33:55000	1258,2607	403,071136	1321,2441	397,573547	229,539398	1920,4088	50,043983	-95,233009
2209	24-06-2021 13:34:00000	1260,8845	401,736328	1323,3374	397,526093	229,511978	1923,741	50,039669	-95,280655
2210	24-06-2021 13:34:05000	1258,7126	406,672455	1322,7772	397,306427	229,385178	1923,9272	50,026733	-95,156799
2211	24-06-2021 13:34:10000	1251,4382	402,210175	1314,485	397,873962	229,71283	1909,166	50,056145	-95,203697
2212	24-06-2021 13:34:15000	1254,0465	399,796631	1316,2333	397,637421	229,576263	1912,8582	50,074345	-95,275398
2213	24-06-2021 13:34:20000	1256,6748	403,402344	1319,8352	397,666229	229,592911	1917,9978	50,082802	-95,214523
2214	24-06-2021 13:34:25000	1256,1366	410,92157	1321,6414	397,795593	229,667603	1919,962	50,091755	-95,043686
2215	24-06-2021 13:34:30000	1263,4617	399,566071	1325,1372	397,236145	229,344589	1927,7139	50,078773	-95,345734
2216	24-06-2021 13:34:35000	1263,616	399,173248	1325,1658	397,443298	229,464188	1926,7512	50,052975	-95,355309

2217	24-06-2021 13:34:40000	1265,6257	406,506989	1329,3068	397,650452	229,583786	1931,7659	50,026936	-95,209457
2218	24-06-2021 13:34:45000	1260,8088	400,881012	1323,0059	397,614441	229,563004	1922,839	50,016109	-95,298813
2219	24-06-2021 13:34:50000	1263,7692	402,788605	1326,4053	397,506927	229,500931	1928,2266	50,007797	-95,277748
2220	24-06-2021 13:34:55000	1259,2028	408,952393	1323,9462	397,527374	229,512741	1924,5756	50,005394	-95,10981
2221	24-06-2021 13:35:00000	1257,9901	405,010468	1321,5796	397,686462	229,604568	1920,4542	50,013786	-95,188377
2222	24-06-2021 13:35:05000	1252,9407	401,472443	1315,6901	397,954712	229,75946	1910,5496	50,04266	-95,230682
2223	24-06-2021 13:35:10000	1250,4564	408,327087	1315,436	397,885162	229,719299	1910,4852	50,065811	-95,060211
2224	24-06-2021 13:35:15000	1258,1804	403,264709	1321,2268	397,501221	229,497635	1920,728	50,071903	-95,228188
2225	24-06-2021 13:35:20000	1257,892	404,33548	1321,2795	397,489105	229,490646	1920,9746	50,069214	-95,202568
2226	24-06-2021 13:35:25000	1268,3633	400,024078	1329,9491	396,708008	229,039673	1937,2188	50,034454	-95,369308
2227	24-06-2021 13:35:30000	1259,4838	403,785248	1322,6268	397,645813	229,581116	1922,0865	50,013905	-95,225929
2228	24-06-2021 13:35:35000	1253,9779	395,65567	1314,9159	398,265717	229,939026	1907,8562	50,030628	-95,365631
2229	24-06-2021 13:35:40000	1243,642	397,093109	1305,4993	398,354767	229,990433	1893,7865	50,098351	-95,261795
2230	24-06-2021 13:35:45000	1254,1906	403,635376	1317,5415	397,987579	229,778427	1912,9581	50,129276	-95,191734
2231	24-06-2021 13:35:50000	1257,9895	403,579834	1321,1412	397,780182	229,658691	1919,2231	50,133408	-95,21991
2232	24-06-2021 13:35:55000	1256,6619	404,216431	1320,072	397,982269	229,77536	1916,7292	50,134834	-95,196465
2233	24-06-2021 13:36:00000	1268,54	408,44693	1332,675	397,758331	229,646072	1936,1144	50,086868	-95,1875
2234	24-06-2021 13:36:05000	1265,2002	401,874451	1327,4918	398,023315	229,799072	1927,353	50,060825	-95,307564
2235	24-06-2021 13:36:10000	1262,302	401,556946	1324,6337	398,102295	229,844666	1922,7358	50,045895	-95,294426
2236	24-06-2021 13:36:15000	1254,0288	403,759491	1317,4254	398,098053	229,842224	1912,3051	50,05278	-95,187836
2237	24-06-2021 13:36:20000	1257,8512	405,06662	1321,4645	397,889862	229,722015	1919,1959	50,054901	-95,186142
2238	24-06-2021 13:36:25000	1248,1357	398,688202	1310,2653	398,196594	229,899124	1901,472	50,087288	-95,258247
2239	24-06-2021 13:36:30000	1256,8971	411,900696	1322,6686	397,588806	229,548203	1922,429	50,091927	-95,027351
2240	24-06-2021 13:36:35000	1258,6162	401,494385	1321,1027	397,773956	229,65509	1919,2368	50,091194	-95,270119
2241	24-06-2021 13:36:40000	1258,2924	404,45285	1321,6964	397,860931	229,705307	1919,7228	50,090748	-95,20282
2242	24-06-2021 13:36:45000	1260,5112	404,946411	1323,9601	397,940002	229,750961	1922,5619	50,089302	-95,207649
2243	24-06-2021 13:36:50000	1257,8488	404,081329	1321,1606	398,216034	229,910324	1917,2402	50,07972	-95,207863
2244	24-06-2021 13:36:55000	1257,0624	398,89447	1318,8337	398,167938	229,882568	1914,1128	50,084858	-95,316208
2245	24-06-2021 13:37:00000	1249,8409	408,627136	1314,9442	398,634064	230,151672	1906,1406	50,106148	-95,048965
2246	24-06-2021 13:37:05000	1254,1426	403,648987	1317,4999	398,186584	229,893326	1912,0869	50,117935	-95,191093



2247	24-06-2021 13:37:10000	1265,6041	412,681091	1331,1873	397,7052	229,615402	1934,2166	50,082508	-95,073334
2248	24-06-2021 13:37:15000	1265,2417	401,434723	1327,3983	398,074005	229,828323	1926,9917	50,050518	-95,317406
2249	24-06-2021 13:37:20000	1254,4515	407,280029	1318,9108	398,700653	230,190125	1911,6184	50,065575	-95,112686
2250	24-06-2021 13:37:25000	1257,0208	408,47052	1321,722	398,489655	230,068298	1916,7351	50,082664	-95,104767
2251	24-06-2021 13:37:30000	1259,4077	404,198364	1322,6807	398,05423	229,81691	1920,218	50,082169	-95,216309
2252	24-06-2021 13:37:35000	1259,7603	407,739319	1324,1024	398,108887	229,848465	1922,0234	50,072674	-95,140694
2253	24-06-2021 13:37:40000	1252,0299	399,812408	1314,3168	398,37207	230,000412	1906,5096	50,094925	-95,260887
2254	24-06-2021 13:37:45000	1255,2572	400,360565	1317,5581	398,11087	229,849625	1912,3934	50,100475	-95,271492
2255	24-06-2021 13:37:50000	1258,6021	398,638336	1320,2241	398,010101	229,791443	1916,8234	50,102261	-95,332458
2256	24-06-2021 13:37:55000	1266,4573	406,301941	1330,0358	397,58313	229,544937	1933,1593	50,049953	-95,219788
2257	24-06-2021 13:38:00000	1259,574	399,069855	1321,2809	398,183716	229,891678	1917,5737	50,021908	-95,329758
2258	24-06-2021 13:38:05000	1254,8882	401,326599	1317,5005	398,163177	229,879837	1912,2817	50,018791	-95,24765
2259	24-06-2021 13:38:10000	1255,222	398,103058	1316,8403	398,112396	229,850479	1911,6034	50,034977	-95,320747
2260	24-06-2021 13:38:15000	1247,9802	396,350433	1309,4076	398,555481	230,106308	1898,5471	50,08112	-95,308762
2261	24-06-2021 13:38:20000	1246,1832	408,643829	1311,4734	398,314606	229,967224	1902,6725	50,128712	-95,021622
2262	24-06-2021 13:38:25000	1266,6888	407,351257	1330,5773	397,767639	229,651443	1933,0599	50,110073	-95,198448
2263	24-06-2021 13:38:30000	1266,1809	396,687256	1326,8666	398,123657	229,856995	1926,04	50,06665	-95,426392
2264	24-06-2021 13:38:35000	1253,9973	399,611023	1316,13	398,77356	230,232224	1907,3658	50,074848	-95,279137
2265	24-06-2021 13:38:40000	1258,7731	406,685028	1322,8387	398,606628	230,135849	1917,8595	50,080299	-95,156952
2266	24-06-2021 13:38:45000	1257,8947	402,759155	1320,8004	398,544281	230,099854	1915,1467	50,083199	-95,237297
2267	24-06-2021 13:38:50000	1256,9495	403,071228	1319,9956	398,580322	230,120651	1913,7428	50,093613	-95,223763
2268	24-06-2021 13:38:55000	1256,1454	397,632721	1317,5785	398,314514	229,967194	1911,45	50,10376	-95,337425
2269	24-06-2021 13:39:00000	1255,5182	415,448761	1322,4688	398,66156	230,167557	1916,8765	50,114815	-94,937454
2270	24-06-2021 13:39:05000	1262,5532	405,483948	1326,0686	398,178375	229,888596	1924,4299	50,101742	-95,210251
2271	24-06-2021 13:39:10000	1263,5995	398,085785	1324,823	398,202148	229,902313	1922,5424	50,079273	-95,378738
2272	24-06-2021 13:39:15000	1275,5961	406,971283	1338,944	397,529144	229,513763	1946,337	50,020157	-95,268814
2273	24-06-2021 13:39:20000	1256,7137	399,576141	1318,7079	398,542145	230,098618	1912,0708	50,010956	-95,298874
2274	24-06-2021 13:39:25000	1244,964	400,628052	1307,8373	398,668365	230,171494	1895,7462	50,05603	-95,192581
2275	24-06-2021 13:39:30000	1254,7747	404,080109	1318,2336	398,315308	229,967636	1912,455	50,085007	-95,18605
2276	24-06-2021 13:39:35000	1258,5548	406,64386	1322,6184	398,230042	229,918427	1919,2653	50,0891	-95,156303

2277	24-06-2021 13:39:40000	1264,8008	400,18338	1326,6001	398,076355	229,829697	1925,751	50,07093	-95,34153
2278	24-06-2021 13:39:45000	1257,5433	398,273895	1319,1047	398,352844	229,989319	1913,5311	50,079731	-95,333092
2279	24-06-2021 13:39:50000	1253,2476	404,790558	1316,9984	398,616394	230,141495	1909,2336	50,100677	-95,159386
2280	24-06-2021 13:39:55000	1261,7747	409,966583	1326,7057	398,253479	229,931961	1925,0648	50,09277	-95,10585
2281	24-06-2021 13:40:00000	1260,2097	396,297211	1321,0527	398,640686	230,155518	1914,886	50,098198	-95,394363
2282	24-06-2021 13:40:05000	1252,4745	406,962555	1316,9324	398,685791	230,181549	1908,7032	50,111057	-95,105453
2283	24-06-2021 13:40:10000	1260,8889	411,192352	1326,2427	398,104736	229,846069	1925,0524	50,091805	-95,07225
2284	24-06-2021 13:40:15000	1260,8667	396,6073	1321,7723	398,196991	229,899338	1918,1176	50,062752	-95,39212
2285	24-06-2021 13:40:20000	1257,5819	400,775085	1319,8987	398,508881	230,079391	1913,9221	50,071327	-95,278656
2286	24-06-2021 13:40:25000	1256,4148	401,774231	1319,0908	398,28891	229,952408	1913,8136	50,082764	-95,248543
2287	24-06-2021 13:40:30000	1262,8884	403,216125	1325,696	398,045135	229,811661	1924,6641	50,073959	-95,262283
2288	24-06-2021 13:40:35000	1250,2787	409,187103	1315,5344	398,366913	229,997437	1908,2319	50,084373	-95,039604
2289	24-06-2021 13:40:40000	1254,7146	397,502747	1316,1753	398,138184	229,865402	1910,2908	50,092373	-95,33036
2290	24-06-2021 13:40:45000	1253,2683	404,17572	1316,8292	398,140564	229,86676	1911,1561	50,105606	-95,17318
2291	24-06-2021 13:40:50000	1259,3737	403,117462	1322,3184	398,170166	229,88385	1919,0603	50,094669	-95,23983
2292	24-06-2021 13:40:55000	1260,6055	402,289063	1323,2395	397,762451	229,648468	1922,2539	50,085777	-95,266617
2293	24-06-2021 13:41:00000	1276,9736	402,134399	1338,7957	396,945587	229,176849	1948,9513	50,026405	-95,382271
2294	24-06-2021 13:41:05000	1257,3372	405,231018	1321,0256	397,820129	229,681778	1918,7981	50,01059	-95,178856
2295	24-06-2021 13:41:10000	1251,3771	394,635986	1312,1288	397,796326	229,668015	1906,1547	50,034267	-95,36998
2296	24-06-2021 13:41:15000	1256,548	404,642639	1320,0941	397,783905	229,660858	1917,6558	50,04744	-95,186241
2297	24-06-2021 13:41:20000	1253,0509	402,904236	1316,2327	398,171356	229,884552	1910,2185	50,068523	-95,199806
2298	24-06-2021 13:41:25000	1246,0188	405,276062	1310,2716	398,41803	230,026962	1900,3818	50,113735	-95,09623
2299	24-06-2021 13:41:30000	1253,2861	397,553009	1314,8286	397,512115	229,503922	1911,3416	50,135098	-95,319344
2300	24-06-2021 13:41:35000	1267,9146	403,74292	1330,6448	397,433929	229,458786	1934,7104	50,096504	-95,285721
2301	24-06-2021 13:41:40000	1268,3207	407,849854	1332,2833	397,786377	229,662277	1935,3105	50,048729	-95,19902
2302	24-06-2021 13:41:45000	1260,8931	402,358307	1323,5345	398,328888	229,97551	1920,2019	50,028553	-95,267113
2303	24-06-2021 13:41:50000	1249,3064	397,985474	1311,167	398,423065	230,029861	1901,6819	50,056786	-95,282021
2304	24-06-2021 13:41:55000	1259,5115	403,9664	1322,7085	397,933167	229,74704	1920,723	50,064857	-95,222145
2305	24-06-2021 13:42:00000	1264,6702	406,270691	1328,3248	397,661987	229,590454	1930,2175	50,039963	-95,207909
2306	24-06-2021 13:42:05000	1259,7678	403,338806	1322,7612	397,486176	229,488968	1923,0151	50,036503	-95,23774

2307	24-06-2021 13:42:10000	1254,9073	410,399292	1320,3107	397,777771	229,657303	1918,1855	50,04739	-95,046379
2308	24-06-2021 13:42:15000	1253,4374	400,181305	1315,7699	397,954681	229,759445	1910,6755	50,056168	-95,262657
2309	24-06-2021 13:42:20000	1262,9222	395,20282	1323,3132	397,723572	229,626022	1923,0168	50,060436	-95,436378
2310	24-06-2021 13:42:25000	1258,577	412,506165	1324,4536	397,978333	229,773102	1923,2079	50,051182	-95,026131
2311	24-06-2021 13:42:30000	1256,9987	397,969147	1318,4935	398,355194	229,990692	1912,8004	50,050694	-95,335976
2312	24-06-2021 13:42:35000	1256,9108	409,084625	1321,8075	397,991699	229,780823	1919,3433	50,069622	-95,090309
2313	24-06-2021 13:42:40000	1262,142	408,844635	1326,7089	397,566437	229,535294	1928,4448	50,060314	-95,133308
2314	24-06-2021 13:42:45000	1254,9496	407,421234	1319,4282	398,036072	229,806442	1915,5811	50,071194	-95,113144
2315	24-06-2021 13:42:50000	1257,6027	405,708008	1321,4248	397,885101	229,719269	1919,2715	50,077251	-95,170204
2316	24-06-2021 13:42:55000	1261,1748	401,036865	1323,4019	397,668335	229,594131	1923,0819	50,054794	-95,297951
2317	24-06-2021 13:43:00000	1254,96	405,543427	1318,8593	398,045013	229,811584	1914,6553	50,057419	-95,154953
2318	24-06-2021 13:43:05000	1256,0165	400,993225	1318,4738	397,892059	229,723282	1914,8558	50,056293	-95,262917
2319	24-06-2021 13:43:10000	1261,6771	399,587708	1323,4423	397,466766	229,477737	1924,1547	50,042229	-95,332993
2320	24-06-2021 13:43:15000	1258,7706	408,193481	1323,3009	397,327789	229,397507	1924,6689	50,042332	-95,123535
2321	24-06-2021 13:43:20000	1260,9783	401,154449	1323,2502	397,327728	229,397476	1924,5568	50,030781	-95,294014
2322	24-06-2021 13:43:25000	1257,7479	397,024109	1318,9231	397,655457	229,586685	1916,6451	50,022732	-95,36174
2323	24-06-2021 13:43:30000	1255,6818	414,391266	1322,2924	397,223083	229,337036	1923,7985	50,02623	-94,962502
2324	24-06-2021 13:43:35000	1245,1498	407,303741	1310,0741	398,402039	230,017731	1900,1453	50,055698	-95,04422
2325	24-06-2021 13:43:40000	1253,5725	405,947052	1317,6635	397,779449	229,658264	1914,3185	50,068756	-95,136017
2326	24-06-2021 13:43:45000	1261,9375	406,784058	1325,8807	397,41748	229,449295	1928,0481	50,053677	-95,177307
2327	24-06-2021 13:43:50000	1258,5006	406,154358	1322,4163	397,751678	229,642227	1921,3352	50,035603	-95,16674
2328	24-06-2021 13:43:55000	1256,2012	404,375549	1319,6823	397,60318	229,556488	1918,1405	50,037998	-95,189674
2329	24-06-2021 13:44:00000	1255,7098	395,362	1316,4795	397,92691	229,743408	1911,9924	50,044094	-95,383926
2330	24-06-2021 13:44:05000	1258,8505	403,05838	1321,8019	397,819122	229,681183	1920,1558	50,046642	-95,237442
2331	24-06-2021 13:44:10000	1256,9706	408,399048	1321,6523	397,81839	229,680756	1919,9429	50,043579	-95,105995
2332	24-06-2021 13:44:15000	1258,355	405,015045	1321,9283	397,669312	229,594696	1921,0004	50,039398	-95,190865
2333	24-06-2021 13:44:20000	1252,1666	405,71701	1316,2551	398,206787	229,904999	1910,2987	50,060276	-95,130997
2334	24-06-2021 13:44:25000	1252,1927	404,30484	1315,8455	397,820007	229,681671	1911,5436	50,08466	-95,162605
2335	24-06-2021 13:44:30000	1258,8932	405,519775	1322,5952	397,843628	229,695328	1921,0706	50,085693	-95,183548
2336	24-06-2021 13:44:35000	1263,7872	404,038696	1326,8027	397,616058	229,56395	1928,3058	50,066093	-95,25058

2337	24-06-2021 13:44:40000	1265,0754	406,909332	1328,9059	397,657135	229,587646	1931,2813	50,037224	-95,196762
2338	24-06-2021 13:44:45000	1262,902	403,442261	1325,778	397,947937	229,755554	1925,3051	50,017689	-95,257431
2339	24-06-2021 13:44:50000	1260,7598	401,589752	1323,174	397,937622	229,749588	1921,6606	50,001106	-95,28299
2340	24-06-2021 13:44:55000	1248,5361	407,833099	1313,4573	398,25293	229,931625	1906,0388	50,029671	-95,05722
2341	24-06-2021 13:45:00000	1253,4884	402,112183	1316,407	398,207764	229,905548	1910,4666	50,053375	-95,220428
2342	24-06-2021 13:45:05000	1259,1033	406,359039	1323,0529	397,725128	229,626907	1922,4071	50,052814	-95,166519
2343	24-06-2021 13:45:10000	1263,4082	399,224792	1324,9833	397,528717	229,513504	1926,1775	50,026978	-95,352768
2344	24-06-2021 13:45:15000	1263,4222	404,727295	1326,6649	397,83667	229,691315	1927,0333	50,002117	-95,232956
2345	24-06-2021 13:45:20000	1256,1324	403,978821	1319,4951	398,007751	229,79007	1915,9646	49,998615	-95,197952
2346	24-06-2021 13:45:25000	1252,7894	402,029083	1315,7161	398,204376	229,903595	1909,4802	50,015217	-95,217308
2347	24-06-2021 13:45:30000	1249,819	401,292847	1312,6626	398,237122	229,922516	1904,7347	50,05896	-95,212494
2348	24-06-2021 13:45:35000	1255,8633	411,16626	1321,4578	398,021027	229,797729	1918,7017	50,067333	-95,036217
2349	24-06-2021 13:45:40000	1267,0757	401,681458	1329,2212	397,531342	229,51503	1932,4312	50,041393	-95,324677
2350	24-06-2021 13:45:45000	1258,5142	402,294434	1321,2489	398,014282	229,793854	1918,5403	50,017975	-95,251862
2351	24-06-2021 13:45:50000	1263,5244	413,909637	1329,592	397,548279	229,524811	1932,7595	49,992233	-95,030983
2352	24-06-2021 13:45:55000	1264,8401	397,188049	1325,7372	397,594055	229,551224	1926,8553	49,967068	-95,406555
2353	24-06-2021 13:46:00000	1254,6196	407,399628	1319,1077	398,342651	229,983429	1913,7813	49,989616	-95,111244
2354	24-06-2021 13:46:05000	1245,8323	400,836914	1308,7278	398,093109	229,839355	1899,7662	50,035885	-95,194153
2355	24-06-2021 13:46:10000	1248,9634	410,034851	1314,5487	398,000916	229,786133	1908,6714	50,066135	-95,010818
2356	24-06-2021 13:46:15000	1265,689	397,440033	1326,6224	397,256866	229,356567	1929,7742	50,039509	-95,406868
2357	24-06-2021 13:46:20000	1262,1116	416,021271	1328,9091	397,518372	229,507523	1931,8197	50,02042	-94,973511
2358	24-06-2021 13:46:25000	1257,2585	404,920532	1320,8557	397,80661	229,67395	1919,0179	50,013527	-95,185158
2359	24-06-2021 13:46:30000	1251,204	394,158264	1311,8202	397,907959	229,732468	1905,1344	50,024666	-95,379234
2360	24-06-2021 13:46:35000	1251,9043	411,450287	1317,7843	397,731567	229,630615	1914,5618	50,047367	-95,000694
2361	24-06-2021 13:46:40000	1254,0909	404,354614	1317,6672	397,818115	229,680603	1914,0187	50,055855	-95,175095
2362	24-06-2021 13:46:45000	1261,2224	401,85379	1323,6951	397,557343	229,530029	1924,036	50,04937	-95,280441
2363	24-06-2021 13:46:50000	1259,5345	405,650848	1323,246	397,639099	229,57724	1922,9258	50,03046	-95,185219
2364	24-06-2021 13:46:55000	1258,5498	398,525879	1320,1403	397,827454	229,685989	1917,5447	50,018738	-95,334549
2365	24-06-2021 13:47:00000	1251,9987	406,180847	1316,2383	398,031097	229,803558	1910,9988	50,046749	-95,119446
2366	24-06-2021 13:47:05000	1258,2908	404,005829	1321,5582	397,608032	229,559311	1920,6661	50,046097	-95,212654

2367	24-06-2021 13:47:10000	1263,7048	408,454742	1328,0758	397,404541	229,441818	1931,0963	50,026466	-95,153069
2368	24-06-2021 13:47:15000	1256,3423	409,765533	1321,4779	397,591766	229,549911	1920,5806	50,017323	-95,071007
2369	24-06-2021 13:47:20000	1251,1823	409,407471	1316,4617	397,833099	229,68924	1912,2081	50,029255	-95,04129
2370	24-06-2021 13:47:25000	1250,6631	399,803894	1313,0122	397,921082	229,740051	1906,7991	50,057381	-95,251434
2371	24-06-2021 13:47:30000	1263,2449	404,430725	1326,4055	397,176575	229,310196	1929,8518	50,042603	-95,238205
2372	24-06-2021 13:47:35000	1264,8013	415,017517	1331,1506	397,198425	229,3228	1936,5533	50,01022	-95,015648
2373	24-06-2021 13:47:40000	1255,9095	397,729645	1317,3828	397,7211	229,624588	1914,0164	50,010811	-95,333679
2374	24-06-2021 13:47:45000	1252,7776	407,749969	1317,4641	397,828217	229,686432	1913,6974	50,038029	-95,090073
2375	24-06-2021 13:47:50000	1260,2466	406,998444	1324,3374	397,346375	229,408234	1925,9226	50,032646	-95,160545
2376	24-06-2021 13:47:55000	1255,4147	398,994843	1317,2938	397,740479	229,635773	1913,8213	50,048435	-95,302559
2377	24-06-2021 13:48:00000	1256,2288	415,355316	1323,114	397,511505	229,503571	1923,532	50,060307	-94,944862
2378	24-06-2021 13:48:05000	1261,8484	401,259399	1324,1112	397,559814	229,531464	1924,5985	50,048325	-95,297768
2379	24-06-2021 13:48:10000	1260,1346	408,515656	1324,6979	397,564392	229,534119	1925,3727	50,033287	-95,126198
2380	24-06-2021 13:48:15000	1260,7642	396,306976	1321,5845	398,713074	230,197311	1916,1444	50,007935	-95,397926
2381	24-06-2021 13:48:20000	1252,8551	390,483978	1312,297	398,975555	230,348846	1901,4557	50,022968	-95,47039
2382	24-06-2021 13:48:25000	1255,7932	394,322998	1316,2473	398,922211	230,318054	1907,3645	50,033085	-95,407082
2383	24-06-2021 13:48:30000	1265,2385	400,623718	1327,1501	398,625061	230,1465	1924,5588	50,011448	-95,334984
2384	24-06-2021 13:48:35000	1258,1475	386,226379	1316,095	398,690277	230,184158	1908,3112	50,006279	-95,597015
2385	24-06-2021 13:48:40000	1251,9828	396,57663	1313,2914	398,732452	230,208496	1904,0646	50,02483	-95,331696
2386	24-06-2021 13:48:45000	1264,0233	399,32666	1325,6006	398,3862	230,008591	1923,4572	50,003887	-95,354767
2387	24-06-2021 13:48:50000	1267,4648	392,433685	1326,8275	398,25238	229,93132	1925,9647	49,966705	-95,52597
2388	24-06-2021 13:48:55000	1262,7841	395,273865	1323,2025	398,544891	230,100204	1919,292	49,95565	-95,433922
2389	24-06-2021 13:49:00000	1260,598	397,214996	1321,6985	398,587006	230,124527	1916,9574	49,947906	-95,377121
2390	24-06-2021 13:49:05000	1256,5612	397,98822	1318,082	398,741425	230,213669	1910,8198	49,961811	-95,332535
2391	24-06-2021 13:49:10000	1245,7681	393,528809	1306,4467	398,989349	230,356812	1892,6348	50,006516	-95,355446
2392	24-06-2021 13:49:15000	1257,6315	404,455872	1321,0682	398,087433	229,83609	1918,0206	50,016811	-95,198067
2393	24-06-2021 13:49:20000	1265,0227	394,09317	1324,9874	398,298828	229,958145	1922,6998	49,991333	-95,474312
2394	24-06-2021 13:49:25000	1242,5638	399,068024	1305,0748	399,312012	230,543091	1889,1117	50,059704	-95,210167
2395	24-06-2021 13:49:30000	1253,7435	402,016754	1316,6209	398,597412	230,130508	1909,2045	50,087402	-95,224342
2396	24-06-2021 13:49:35000	1262,6024	393,410034	1322,4735	398,52417	230,088242	1917,9696	50,075104	-95,472794

2397	24-06-2021 13:49:40000	1263,0165	393,960297	1323,0327	398,527252	230,090027	1918,6726	50,060707	-95,463745
2398	24-06-2021 13:49:45000	1259,8904	405,381287	1323,5021	398,801117	230,248138	1918,0811	50,061619	-95,19368
2399	24-06-2021 13:49:50000	1260,4943	398,089478	1321,8628	398,770538	230,230484	1915,9207	50,060329	-95,35743
2400	24-06-2021 13:49:55000	1254,0844	410,787567	1319,6492	398,493713	230,070663	1913,7694	50,081333	-95,031647
2401	24-06-2021 13:50:00000	1257,8246	401,993774	1320,5006	398,016541	229,795151	1917,2079	50,084145	-95,253624
2402	24-06-2021 13:50:05000	1255,2106	405,632019	1319,125	397,95694	229,760742	1915,4613	50,084778	-95,154785
2403	24-06-2021 13:50:10000	1270,8883	406,258728	1334,2426	397,317413	229,391525	1940,4658	50,036388	-95,251671
2404	24-06-2021 13:50:15000	1263,7833	400,222076	1325,6417	397,550507	229,526093	1926,8402	50,010628	-95,333702
2405	24-06-2021 13:50:20000	1256,0341	399,701813	1318,0983	398,14917	229,871735	1913,0297	50,021759	-95,291382
2406	24-06-2021 13:50:25000	1255,1245	403,88974	1318,5084	398,048004	229,813324	1914,127	50,030087	-95,192757
2407	24-06-2021 13:50:30000	1253,2571	403,912628	1316,7379	398,251099	229,930573	1910,5802	50,043175	-95,178932
2408	24-06-2021 13:50:35000	1253,9591	399,644867	1316,1039	397,823456	229,683685	1911,7245	50,062786	-95,278122
2409	24-06-2021 13:50:40000	1264,5986	394,221771	1324,6209	397,031769	229,226593	1927,9514	50,039967	-95,468719
2410	24-06-2021 13:50:45000	1261,9517	397,24173	1322,9978	397,553375	229,527756	1923,1862	50,017159	-95,38578
2411	24-06-2021 13:50:50000	1250,9043	416,35733	1318,3759	398,226105	229,916138	1913,1458	50,033646	-94,882217
2412	24-06-2021 13:50:55000	1256,5834	406,904388	1320,8229	397,692627	229,608124	1919,225	50,046741	-95,136406
2413	24-06-2021 13:51:00000	1265,0907	400,717377	1327,0376	397,324677	229,395706	1930,0792	50,020916	-95,33194
2414	24-06-2021 13:51:05000	1256,3674	392,715393	1316,3147	397,870422	229,710785	1912,047	50,019909	-95,445824
2415	24-06-2021 13:51:10000	1251,3629	413,898499	1318,0369	398,114441	229,851654	1913,194	50,042934	-94,941422
2416	24-06-2021 13:51:15000	1253,1775	411,159119	1318,9031	397,850983	229,69957	1915,646	50,071934	-95,01664
2417	24-06-2021 13:51:20000	1269,0529	403,095154	1331,5333	396,878937	229,138351	1938,6989	50,030693	-95,307632
2418	24-06-2021 13:51:25000	1271,1036	408,056549	1334,9961	396,925415	229,165192	1943,5928	49,972481	-95,214035
2419	24-06-2021 13:51:30000	1261,7383	396,140076	1322,4639	397,925781	229,742752	1920,5631	49,941883	-95,408157
2420	24-06-2021 13:51:35000	1247,1473	406,543457	1311,7371	397,93985	229,75087	1904,8667	49,984344	-95,076019
2421	24-06-2021 13:51:40000	1255,6404	409,56958	1320,7499	397,712708	229,619751	1919,104	50,008598	-95,070267
2422	24-06-2021 13:51:45000	1247,6047	407,756439	1312,5483	397,812256	229,6772	1906,7195	50,051582	-95,052109
2423	24-06-2021 13:51:50000	1249,8207	395,827209	1311,0039	397,657776	229,588013	1905,1735	50,089432	-95,333115
2424	24-06-2021 13:51:55000	1256,2517	408,523621	1321,0071	397,110748	229,272186	1922,376	50,092419	-95,098022
2425	24-06-2021 13:52:00000	1265,0039	405,014008	1328,2588	397,102905	229,26767	1932,8652	50,057442	-95,237762
2426	24-06-2021 13:52:05000	1262,364	403,860382	1325,3928	397,435333	229,459579	1927,1725	50,030579	-95,244522

2427	24-06-2021 13:52:10000	1256,3831	402,477356	1319,2749	397,828278	229,686447	1916,5408	50,028477	-95,232841
2428	24-06-2021 13:52:15000	1261,0901	403,460541	1324,0576	397,24231	229,348129	1926,2759	50,022602	-95,244347
2429	24-06-2021 13:52:20000	1262,4451	393,710754	1322,4128	397,583893	229,545364	1922,1761	50,008759	-95,465279
2430	24-06-2021 13:52:25000	1248,0139	395,857574	1309,2906	398,151794	229,87323	1900,4526	50,049786	-95,319855
2431	24-06-2021 13:52:30000	1244,5719	407,980377	1309,7355	398,102753	229,84491	1901,3298	50,110794	-95,024673
2432	24-06-2021 13:52:35000	1262,4779	403,725433	1325,4602	397,036896	229,229538	1929,338	50,105827	-95,248268
2433	24-06-2021 13:52:40000	1270,0756	406,235382	1333,4613	397,014557	229,21666	1941,011	50,057854	-95,246521
2434	24-06-2021 13:52:45000	1264,1992	402,80957	1326,8215	397,666748	229,593201	1928,3302	50,039268	-95,280281
2435	24-06-2021 13:52:50000	1252,8319	395,850983	1313,882	397,81488	229,678726	1908,7926	50,03812	-95,353462
2436	24-06-2021 13:52:55000	1256,7268	405,765198	1320,6089	397,805237	229,673157	1918,5566	50,051476	-95,162682
2437	24-06-2021 13:53:00000	1256,0865	403,442566	1319,2875	397,822418	229,683075	1916,4487	50,062	-95,209473
2438	24-06-2021 13:53:05000	1264,1273	396,73822	1324,9224	397,241058	229,347412	1927,4644	50,040012	-95,41143
2439	24-06-2021 13:53:10000	1260,5786	401,904663	1323,097	397,201111	229,324371	1925,1022	50,017288	-95,274841
2440	24-06-2021 13:53:15000	1259,0432	397,245239	1320,2247	397,300201	229,381577	1920,3949	50,019787	-95,365822
2441	24-06-2021 13:53:20000	1258,8467	405,622162	1322,5825	397,132782	229,284897	1924,5344	50,011898	-95,180962
2442	24-06-2021 13:53:25000	1259,9233	401,304474	1322,2904	396,876617	229,137009	1925,2723	50,004292	-95,283401
2443	24-06-2021 13:53:30000	1257,5327	409,143036	1322,417	397,24826	229,351563	1923,7789	50,006134	-95,093513
2444	24-06-2021 13:53:35000	1258,4677	409,952271	1323,5564	397,095428	229,263336	1926,0656	50,002663	-95,082283
2445	24-06-2021 13:53:40000	1254,4741	406,969574	1318,8364	397,287445	229,374191	1918,3407	50,013294	-95,119766
2446	24-06-2021 13:53:45000	1250,2351	403,499481	1313,735	397,460663	229,474213	1910,0492	50,046375	-95,166458
2447	24-06-2021 13:53:50000	1257,1454	404,947266	1320,7561	397,484192	229,487793	1920,0885	50,06522	-95,183762
2448	24-06-2021 13:53:55000	1259,8182	399,428802	1321,6223	397,246582	229,350616	1922,5691	50,066422	-95,323624
2449	24-06-2021 13:54:00000	1271,4747	403,004913	1333,8143	396,986389	229,200394	1941,6205	50,024582	-95,32621
2450	24-06-2021 13:54:05000	1252,7119	405,459656	1316,6945	397,77417	229,655212	1912,8229	50,020866	-95,140656
2451	24-06-2021 13:54:10000	1251,4723	402,702454	1314,6681	397,753418	229,643234	1910,0146	50,043472	-95,193024
2452	24-06-2021 13:54:15000	1252,6879	403,40979	1316,0419	397,582153	229,544357	1912,7517	50,067974	-95,186012
2453	24-06-2021 13:54:20000	1265,0829	405,241882	1328,4034	397,08316	229,256241	1933,2097	50,053684	-95,233337
2454	24-06-2021 13:54:25000	1258,2245	398,715637	1319,8875	397,804962	229,672989	1917,4299	50,040836	-95,328163
2455	24-06-2021 13:54:30000	1255,2998	406,100708	1319,3542	397,813019	229,677628	1916,5896	50,054207	-95,14502
2456	24-06-2021 13:54:35000	1258,6631	401,420227	1321,1249	397,506348	229,500595	1920,5372	50,045895	-95,272072

2457	24-06-2021 13:54:40000	1265,0244	403,437225	1327,7985	397,522491	229,509903	1930,2338	50,016258	-95,272331
2458	24-06-2021 13:54:45000	1256,3085	409,569336	1321,3849	397,595825	229,552246	1920,5134	50,014248	-95,075134
2459	24-06-2021 13:54:50000	1255,9963	402,707123	1318,9768	397,516602	229,5065	1917,4857	50,026535	-95,225052
2460	24-06-2021 13:54:55000	1251,3979	397,373199	1312,9745	397,748077	229,640152	1907,5341	50,050507	-95,310143
2461	24-06-2021 13:55:00000	1255,6383	411,781311	1321,4354	397,611511	229,56131	1920,4125	50,067379	-95,02079
2462	24-06-2021 13:55:05000	1264,6354	404,903809	1327,8741	397,316833	229,391174	1931,2683	50,051365	-95,237595
2463	24-06-2021 13:55:10000	1267,2354	400,577301	1329,04	397,348999	229,409744	1932,7893	50,027824	-95,34967
2464	24-06-2021 13:55:15000	1259,9858	399,632721	1321,8436	397,648193	229,582489	1921,0308	50,016754	-95,320335
2465	24-06-2021 13:55:20000	1263,5057	407,017578	1327,4451	397,499451	229,496597	1929,8322	50,004154	-95,183289
2466	24-06-2021 13:55:25000	1254,4231	404,253204	1317,9521	397,926819	229,743332	1914,006	50,015667	-95,17971
2467	24-06-2021 13:55:30000	1256,0773	399,740692	1318,1512	397,829407	229,687088	1914,8442	50,031574	-95,290833
2468	24-06-2021 13:55:35000	1255,429	407,914337	1320,0364	397,660736	229,589722	1918,2455	50,057167	-95,105637
2469	24-06-2021 13:55:40000	1259,7354	405,673279	1323,444	397,218536	229,334412	1925,4183	50,047634	-95,18615
2470	24-06-2021 13:55:45000	1258,5062	401,513855	1321,0039	397,760681	229,64743	1919,0938	50,041042	-95,268929
2471	24-06-2021 13:55:50000	1257,9349	400,02179	1320,0067	397,837799	229,691956	1917,3522	50,033627	-95,297615
2472	24-06-2021 13:55:55000	1255,9128	406,46051	1320,0482	397,872131	229,711777	1917,3483	50,040699	-95,141441
2473	24-06-2021 13:56:00000	1256,9648	403,475311	1320,1338	397,704224	229,614822	1918,2114	50,041996	-95,214966
2474	24-06-2021 13:56:05000	1252,7686	408,698212	1317,7494	397,648895	229,582886	1915,0029	50,058693	-95,06881
2475	24-06-2021 13:56:10000	1252,4756	405,579773	1316,5068	397,776947	229,656799	1912,5499	50,074131	-95,136284
2476	24-06-2021 13:56:15000	1262,9341	398,394043	1324,2811	397,33136	229,399567	1925,8848	50,066425	-95,367523
2477	24-06-2021 13:56:20000	1258,7426	406,008087	1322,6017	397,578766	229,542389	1922,3505	50,056995	-95,1717
2478	24-06-2021 13:56:25000	1269,9944	392,07373	1329,1379	397,467651	229,478256	1932,3386	50,027889	-95,550232
2479	24-06-2021 13:56:30000	1263,4899	410,855713	1328,6117	397,599304	229,554245	1931,075	50,006721	-95,098503
2480	24-06-2021 13:56:35000	1258,2552	404,03653	1321,5339	397,604523	229,557266	1920,6738	50,003448	-95,211731
2481	24-06-2021 13:56:40000	1258,7467	396,205627	1319,6295	397,532776	229,515839	1918,2045	50,008423	-95,386368
2482	24-06-2021 13:56:45000	1248,6327	411,425537	1314,6689	397,992798	229,781448	1908,8599	50,022732	-94,976959
2483	24-06-2021 13:56:50000	1255,6979	401,41629	1318,299	397,56488	229,534378	1916,1584	50,043179	-95,251373
2484	24-06-2021 13:56:55000	1256,625	407,079712	1320,9165	397,629974	229,571945	1919,816	50,057674	-95,132813
2485	24-06-2021 13:57:00000	1257,521	399,232025	1319,373	397,427948	229,455322	1918,2919	50,056858	-95,312012
2486	24-06-2021 13:57:05000	1265,6698	410,869781	1330,6893	397,53772	229,518707	1934,3287	50,018471	-95,113846



2487	24-06-2021 13:57:10000	1266,3909	396,819763	1327,1066	397,606171	229,558228	1928,7904	49,991894	-95,424957
2488	24-06-2021 13:57:15000	1256,8596	399,06723	1318,6929	397,954315	229,759216	1914,9143	50,001999	-95,31102
2489	24-06-2021 13:57:20000	1247,8279	412,012695	1314,0886	398,159882	229,877899	1907,2195	50,030151	-94,957664
2490	24-06-2021 13:57:25000	1254,5725	395,142212	1315,3286	398,048859	229,813797	1909,5934	50,059612	-95,380913
2491	24-06-2021 13:57:30000	1257,6875	408,044495	1322,2246	397,771271	229,653534	1921,0018	50,063854	-95,119041
2492	24-06-2021 13:57:35000	1259,2108	405,80545	1322,9852	397,66803	229,593948	1922,5482	50,052879	-95,179504
2493	24-06-2021 13:57:40000	1261,6317	402,851593	1324,3882	397,673981	229,597366	1924,5647	50,031719	-95,261475
2494	24-06-2021 13:57:45000	1258,2863	404,103149	1321,5837	397,87381	229,712753	1919,5085	50,016205	-95,21048
2495	24-06-2021 13:57:50000	1253,5272	394,78952	1314,2257	397,904358	229,730377	1908,7245	50,011513	-95,381424
2496	24-06-2021 13:57:55000	1253,3427	411,257385	1319,0908	398,109833	229,849014	1914,7803	50,026184	-95,015648
2497	24-06-2021 13:58:00000	1251,8732	405,818451	1316,0073	398,105286	229,846375	1910,2739	50,046928	-95,126617
2498	24-06-2021 13:58:05000	1255,9799	409,251495	1320,974	397,773071	229,654587	1919,2129	50,053806	-95,079834
2499	24-06-2021 13:58:10000	1264,8932	401,257416	1327,0126	397,69632	229,610275	1928,2705	50,034595	-95,318855
2500	24-06-2021 13:58:15000	1258,1697	402,958374	1321,1232	397,97403	229,770615	1918,4242	50,027058	-95,234848
2501	24-06-2021 13:58:20000	1255,1436	410,717804	1320,6342	397,996094	229,783356	1917,5126	50,031681	-95,040977
2502	24-06-2021 13:58:25000	1260,6979	398,592773	1322,2085	397,635284	229,575027	1921,7488	50,019531	-95,347885
2503	24-06-2021 13:58:30000	1258,9683	406,509521	1322,9706	397,348938	229,409698	1924,2334	49,996162	-95,162231
2504	24-06-2021 13:58:35000	1256,5918	400,165863	1318,7706	397,784088	229,66095	1915,9417	50,000362	-95,285103
2505	24-06-2021 13:58:40000	1249,4835	407,319153	1314,1987	398,032104	229,804123	1908,1095	50,028362	-95,075699
2506	24-06-2021 13:58:45000	1248,8345	402,906799	1312,2201	398,100006	229,843323	1905,0269	50,061462	-95,169594
2507	24-06-2021 13:58:50000	1255,4851	401,181488	1318,0249	397,776886	229,656769	1914,9575	50,081886	-95,255043
2508	24-06-2021 13:58:55000	1262,042	406,444702	1325,8761	397,773834	229,655029	1926,3202	50,068295	-95,185516
2509	24-06-2021 13:59:00000	1250,4342	408,664124	1315,5197	399,088501	230,414032	1904,9779	50,082359	-95,05249
2510	24-06-2021 13:59:05000	1248,3016	395,982849	1309,6028	398,520966	230,08638	1899,1754	50,108665	-95,319107
2511	24-06-2021 13:59:10000	1260,2509	404,274536	1323,5067	398,432983	230,035583	1919,6665	50,110367	-95,220581
2512	24-06-2021 13:59:15000	1263,1246	400,033081	1324,9568	398,218231	229,911591	1922,8695	50,0868	-95,333275
2513	24-06-2021 13:59:20000	1255,2908	403,02832	1318,4031	398,647888	230,159668	1911,3446	50,093113	-95,212975
2514	24-06-2021 13:59:25000	1256,9617	400,458374	1319,2118	398,259369	229,935349	1914,4548	50,087708	-95,281265
2515	24-06-2021 13:59:30000	1265,7983	396,218475	1326,3615	398,225189	229,915604	1924,8286	50,063416	-95,433899
2516	24-06-2021 13:59:35000	1258,8575	413,006531	1324,8761	398,265533	229,938904	1922,4521	50,049316	-95,016998

2517	24-06-2021 13:59:40000	1254,8737	397,403503	1316,2969	398,082214	229,833069	1911,0298	50,044464	-95,333633
2518	24-06-2021 13:59:45000	1262,7279	406,902161	1326,6693	397,918488	229,738541	1926,7625	50,031223	-95,180313
2519	24-06-2021 13:59:50000	1255,1307	406,513184	1319,3204	398,197021	229,899353	1914,8823	50,047432	-95,134644
2520	24-06-2021 13:59:55000	1252,3861	407,084259	1316,8859	398,139587	229,866196	1911,4423	50,067261	-95,102097
2521	24-06-2021 14:00:00000	1262,0403	407,652222	1326,2451	397,854218	229,701431	1926,4255	50,056671	-95,158905
2522	24-06-2021 14:00:05000	1257,8084	409,7966	1322,8813	398,268188	229,94043	1919,619	50,049976	-95,080963
2523	24-06-2021 14:00:10000	1253,6019	403,626984	1316,9786	398,438232	230,03862	1910,1759	50,064884	-95,187721
2524	24-06-2021 14:00:15000	1257,1438	405,263672	1320,8517	397,608185	229,559387	1919,7579	50,064339	-95,176758
2525	24-06-2021 14:00:20000	1271,4248	399,427063	1332,6901	397,495941	229,494583	1937,642	50,008751	-95,402885
2526	24-06-2021 14:00:25000	1265,517	403,803619	1328,3789	397,893951	229,72438	1929,3182	49,977741	-95,267769
2527	24-06-2021 14:00:30000	1251,3993	402,878235	1314,6525	398,31955	229,970093	1907,4744	49,998341	-95,188599
2528	24-06-2021 14:00:35000	1249,4407	409,92038	1314,9664	398,232025	229,919556	1908,3406	50,038315	-95,01693
2529	24-06-2021 14:00:40000	1257,1499	407,506622	1321,5474	398,035645	229,806168	1918,8306	50,042553	-95,127113
2530	24-06-2021 14:00:45000	1260,3257	404,289886	1323,5826	397,942108	229,752167	1922,1277	50,035469	-95,220772
2531	24-06-2021 14:00:50000	1259,861	400,852875	1322,0941	398,396301	230,014389	1917,9226	50,040215	-95,292839
2532	24-06-2021 14:00:55000	1251,6278	408,740814	1316,6782	398,582947	230,122162	1909,1505	50,070156	-95,059517
2533	24-06-2021 14:01:00000	1259,9657	405,07605	1323,4803	398,143402	229,868378	1921,0916	50,081051	-95,200943
2534	24-06-2021 14:01:05000	1264,3524	416,720642	1331,2561	397,661804	229,590363	1934,6348	50,038956	-94,974388
2535	24-06-2021 14:01:10000	1265,2385	397,926086	1326,3384	397,705597	229,615631	1927,3936	50,003529	-95,393341
2536	24-06-2021 14:01:15000	1254,5779	402,897858	1317,6844	398,291107	229,953674	1912,0642	50,013042	-95,2108
2537	24-06-2021 14:01:20000	1251,2584	404,81192	1315,1122	398,243286	229,926071	1908,527	50,034058	-95,144608
2538	24-06-2021 14:01:25000	1248,9176	406,300934	1313,3452	398,523285	230,087723	1904,6066	50,072365	-95,094391
2539	24-06-2021 14:01:30000	1252,071	398,093323	1313,8342	397,980072	229,774094	1907,7374	50,096638	-95,299019
2540	24-06-2021 14:01:35000	1270,9745	410,061646	1335,4873	397,227295	229,339478	1942,9525	50,050728	-95,169334
2541	24-06-2021 14:01:40000	1264,8212	400,15155	1326,6099	397,799774	229,670013	1927,2595	50,017227	-95,342361
2542	24-06-2021 14:01:45000	1256,8042	405,345551	1320,5536	398,081238	229,83252	1917,1567	50,020756	-95,172523
2543	24-06-2021 14:01:50000	1253,2432	405,667633	1317,264	398,330902	229,976654	1911,2242	50,036743	-95,139854
2544	24-06-2021 14:01:55000	1252,9175	406,879608	1317,328	398,272522	229,942947	1911,4354	50,056149	-95,110512
2545	24-06-2021 14:02:00000	1256,1357	400,541809	1318,4501	398,268005	229,940338	1913,1626	50,061012	-95,273666
2546	24-06-2021 14:02:05000	1260,02	402,434204	1322,7258	397,857513	229,703339	1921,328	50,047596	-95,259346

2547	24-06-2021 14:02:10000	1265,7277	399,018982	1327,1333	397,844299	229,695709	1927,7772	50,018379	-95,37307
2548	24-06-2021 14:02:15000	1257,6447	404,812195	1321,1901	398,244324	229,926666	1917,1968	50,022144	-95,190292
2549	24-06-2021 14:02:20000	1251,2314	410,474548	1316,8408	398,442749	230,041214	1910,0593	50,033669	-95,017677
2550	24-06-2021 14:02:25000	1254,8209	401,063324	1317,3561	398,052582	229,815964	1912,5121	50,041904	-95,252975
2551	24-06-2021 14:02:30000	1261,5706	399,173767	1323,2157	397,866364	229,70845	1921,9874	50,027748	-95,341255
2552	24-06-2021 14:02:35000	1261,5315	409,201691	1326,2383	397,899719	229,727707	1926,222	50,010021	-95,121033
2553	24-06-2021 14:02:40000	1258,0807	404,191742	1321,4152	398,052185	229,815735	1918,5629	50,00861	-95,207077
2554	24-06-2021 14:02:45000	1255,4042	397,172302	1316,7329	398,243042	229,925919	1910,8746	50,01524	-95,342361
2555	24-06-2021 14:02:50000	1256,3625	403,197449	1319,4753	398,104492	229,845932	1915,488	50,018764	-95,216827
2556	24-06-2021 14:02:55000	1254,7515	415,128601	1321,6403	398,057343	229,81871	1919,0294	50,031937	-94,938957
2557	24-06-2021 14:03:00000	1257,812	391,17926	1317,2366	399,303192	230,53801	1907,5005	50,038074	-95,488693
2558	24-06-2021 14:03:05000	1251,0311	397,270966	1312,5941	399,865417	230,86261	1898,3386	50,054611	-95,30983
2559	24-06-2021 14:03:10000	1263,2815	393,777252	1323,2312	399,126862	230,436203	1916,9862	50,04147	-95,469452
2560	24-06-2021 14:03:15000	1257,1436	389,904053	1316,22	399,639618	230,732239	1904,5221	50,030067	-95,511658
2561	24-06-2021 14:03:20000	1245,5804	397,743805	1307,5438	400,153534	231,028946	1889,6089	50,077656	-95,261086
2562	24-06-2021 14:03:25000	1258,3723	391,057404	1317,7355	399,152039	230,450729	1908,9209	50,098873	-95,495064
2563	24-06-2021 14:03:30000	1260,3206	402,79361	1323,1216	399,304077	230,538513	1915,9155	50,086838	-95,253578
2564	24-06-2021 14:03:35000	1265,9175	392,876099	1325,4805	399,296387	230,534088	1919,368	50,054813	-95,506302
2565	24-06-2021 14:03:40000	1262,2332	386,899139	1320,1982	399,07312	230,405167	1912,7445	50,037518	-95,60936
2566	24-06-2021 14:03:45000	1264,7378	394,322052	1324,7837	399,143494	230,445801	1919,0397	50,004738	-95,467499
2567	24-06-2021 14:03:50000	1258,2338	397,204956	1319,4408	399,362305	230,572128	1910,2125	49,996956	-95,361137
2568	24-06-2021 14:03:55000	1253,1741	390,54425	1312,6196	399,328308	230,552505	1900,502	50,019817	-95,471237
2569	24-06-2021 14:04:00000	1255,2789	394,787262	1315,8959	399,251404	230,508087	1905,7012	50,044502	-95,393478
2570	24-06-2021 14:04:05000	1258,4476	406,994568	1322,6243	399,184753	230,469635	1915,7086	50,042068	-95,147781
2571	24-06-2021 14:04:10000	1256,3411	392,899261	1316,3444	399,172119	230,462326	1906,6888	50,037292	-95,441666
2572	24-06-2021 14:04:15000	1256,3495	392,09848	1316,1138	399,210449	230,484451	1906,1841	50,04332	-95,459038
2573	24-06-2021 14:04:20000	1254,5159	402,294098	1317,4409	399,329071	230,552933	1907,4341	50,056751	-95,223694
2574	24-06-2021 14:04:25000	1258,3254	393,233185	1318,338	399,208588	230,483383	1909,266	50,056099	-95,447861
2575	24-06-2021 14:04:30000	1258,5903	390,042938	1317,6431	399,777557	230,81189	1905,7266	50,060493	-95,518311
2576	24-06-2021 14:04:35000	1260,366	391,625793	1319,808	399,013702	230,37088	1912,4601	50,061649	-95,496162

2577	24-06-2021 14:04:40000	1265,1708	397,47757	1326,1394	399,136353	230,441681	1921,0996	50,037621	-95,40255
2578	24-06-2021 14:04:45000	1262,6587	398,691528	1324,1079	399,072021	230,404556	1918,2654	50,0182	-95,359192
2579	24-06-2021 14:04:50000	1264,7333	396,903137	1325,5498	398,947845	230,332855	1921,0691	50,000038	-95,411972
2580	24-06-2021 14:04:55000	1263,078	397,0177	1324,0049	398,936249	230,326172	1918,7484	49,984688	-95,398285
2581	24-06-2021 14:05:00000	1251,5007	396,862305	1312,9181	399,345123	230,562225	1900,8027	50,008522	-95,322075
2582	24-06-2021 14:05:05000	1258,5072	401,00238	1320,8495	398,940979	230,328888	1914,1471	50,015743	-95,280144
2583	24-06-2021 14:05:10000	1259,7135	391,047943	1319,0134	398,81189	230,254379	1912,1656	50,014343	-95,504219
2584	24-06-2021 14:05:15000	1257,4309	387,734161	1315,8534	398,978241	230,350403	1906,8423	50,01889	-95,560104
2585	24-06-2021 14:05:20000	1258,7465	395,420502	1319,3938	398,965118	230,342834	1911,9695	50,020027	-95,403397
2586	24-06-2021 14:05:25000	1254,5388	394,660187	1315,1519	399,361206	230,571518	1903,9104	50,036964	-95,391182
2587	24-06-2021 14:05:30000	1251,6021	399,20105	1313,7235	399,103638	230,422806	1903,0082	50,066101	-95,271355
2588	24-06-2021 14:05:35000	1260,6554	395,837158	1321,3398	398,663696	230,168793	1916,1486	50,05373	-95,407356
2589	24-06-2021 14:05:40000	1261,9069	385,836609	1319,5752	398,903534	230,307281	1912,4657	50,03569	-95,629776
2590	24-06-2021 14:05:45000	1255,2288	391,904388	1314,9861	399,358398	230,569885	1903,6226	50,045227	-95,455673
2591	24-06-2021 14:05:50000	1258,4781	406,769928	1322,5842	399,145233	230,446808	1915,6395	50,046593	-95,152969
2592	24-06-2021 14:05:55000	1247,6155	391,504059	1307,6008	399,59726	230,707794	1891,7773	50,085999	-95,412567
2593	24-06-2021 14:06:00000	1263,5862	393,411774	1323,4133	398,99762	230,361588	1917,5305	50,075176	-95,479332
2594	24-06-2021 14:06:05000	1264,8599	396,392578	1325,5179	398,993042	230,358948	1920,6616	50,052406	-95,423828
2595	24-06-2021 14:06:10000	1259,8053	399,360321	1321,5891	399,32373	230,549866	1913,3955	50,044865	-95,325027
2596	24-06-2021 14:06:15000	1251,3953	397,697388	1313,0703	399,461761	230,629547	1900,4164	50,075333	-95,303001
2597	24-06-2021 14:06:20000	1262,9365	387,90744	1321,1665	398,669006	230,17186	1915,8379	50,062344	-95,592537
2598	24-06-2021 14:06:25000	1263,8212	396,109741	1324,4421	399,105896	230,424118	1918,5354	50,043915	-95,422913
2599	24-06-2021 14:06:30000	1263,1331	403,08432	1325,8892	399,199463	230,478134	1920,0703	50,028793	-95,266869
2600	24-06-2021 14:06:35000	1263,4205	390,783997	1322,4764	399,157135	230,45369	1915,394	50,018257	-95,534454
2601	24-06-2021 14:06:40000	1257,8468	393,601196	1317,9911	399,658112	230,742935	1906,5997	50,035019	-95,436668
2602	24-06-2021 14:06:45000	1254,0359	394,361115	1314,5824	399,261688	230,514053	1903,4735	50,058929	-95,394249
2603	24-06-2021 14:06:50000	1260,4819	393,615326	1320,5104	399,099152	230,420212	1912,78	50,062294	-95,454147
2604	24-06-2021 14:06:55000	1255,4218	398,218811	1317,0657	399,191406	230,473465	1907,3732	50,08342	-95,319603
2605	24-06-2021 14:07:00000	1256,8838	398,800079	1318,635	399,369965	230,576569	1908,8352	50,082726	-95,317032
2606	24-06-2021 14:07:05000	1266,8113	398,526062	1328,0187	398,586212	230,124054	1926,1846	50,055729	-95,391068

2607	24-06-2021 14:07:10000	1270,4397	393,808136	1330,0759	398,502686	230,075851	1929,6132	50,009075	-95,516335
2608	24-06-2021 14:07:15000	1263,1725	395,13623	1323,5321	398,883057	230,295456	1918,2561	49,995682	-95,439499
2609	24-06-2021 14:07:20000	1258,8497	397,05365	1319,9827	399,183563	230,468948	1911,6395	50,00547	-95,36866
2610	24-06-2021 14:07:25000	1255,0597	391,706451	1314,7656	398,784424	230,238495	1905,9478	50,017582	-95,458809
2611	24-06-2021 14:07:30000	1263,6066	389,328461	1322,2247	398,389282	230,010376	1918,6383	49,996265	-95,566704
2612	24-06-2021 14:07:35000	1265,71	389,121521	1324,1742	398,32901	229,975571	1921,7742	49,966068	-95,584854
2613	24-06-2021 14:07:40000	1270,0148	390,417816	1328,6697	398,326843	229,974335	1928,3475	49,925056	-95,585426
2614	24-06-2021 14:07:45000	1255,0872	392,329529	1314,9777	398,671753	230,173447	1906,8763	49,939709	-95,445511
2615	24-06-2021 14:07:50000	1251,4684	389,007874	1310,5343	398,891846	230,300522	1899,3243	49,974117	-95,492989
2616	24-06-2021 14:07:55000	1257,0959	398,435272	1318,7269	398,364624	229,99614	1913,7802	50,002594	-95,326477
2617	24-06-2021 14:08:00000	1263,5856	402,295929	1326,0809	398,126312	229,858551	1925,5172	49,984756	-95,287216
2618	24-06-2021 14:08:05000	1264,615	388,16745	1322,8473	398,376526	230,003006	1919,6339	49,959766	-95,597954
2619	24-06-2021 14:08:10000	1257,0227	398,640991	1318,7194	398,75589	230,222031	1911,9365	49,965294	-95,321472
2620	24-06-2021 14:08:15000	1259,5968	398,63797	1321,1724	398,258423	229,93483	1917,3097	49,968964	-95,339325
2621	24-06-2021 14:08:20000	1258,5167	396,449799	1319,4836	397,703491	229,614426	1917,1763	49,969837	-95,379494
2622	24-06-2021 14:08:25000	1249,5975	404,337708	1313,3861	397,903992	229,730179	1907,3322	50,005371	-95,143204
2623	24-06-2021 14:08:30000	1255,0504	402,891052	1318,1322	397,618774	229,565506	1915,4873	50,030674	-95,214302
2624	24-06-2021 14:08:35000	1263,6476	402,566437	1326,222	397,527893	229,513046	1927,7601	50,022118	-95,281754
2625	24-06-2021 14:08:40000	1263,0239	402,476563	1325,6006	397,618164	229,56517	1926,354	50,004826	-95,279373
2626	24-06-2021 14:08:45000	1256,7618	400,638397	1319,0761	397,756958	229,645279	1916,3335	50,009712	-95,275925
2627	24-06-2021 14:08:50000	1258,0131	409,029022	1322,8385	397,740814	229,635971	1921,7684	50,01675	-95,099525
2628	24-06-2021 14:08:55000	1259,6276	401,698486	1322,1283	397,459137	229,473343	1922,0781	50,017876	-95,27272
2629	24-06-2021 14:09:00000	1267,0713	396,53656	1327,6713	396,658478	229,011078	1934,0258	49,982754	-95,435623
2630	24-06-2021 14:09:05000	1264,7118	409,051025	1329,2174	397,086914	229,258438	1934,2177	49,954643	-95,147102
2631	24-06-2021 14:09:10000	1264,1147	404,996857	1327,4066	397,114197	229,2742	1931,4862	49,930599	-95,231911
2632	24-06-2021 14:09:15000	1253,2305	402,519257	1316,2859	397,570923	229,537888	1913,0502	49,942669	-95,209602
2633	24-06-2021 14:09:20000	1253,5328	401,775177	1316,3464	397,35437	229,412857	1914,2838	49,961483	-95,228188
2634	24-06-2021 14:09:25000	1255,3048	403,648743	1318,6063	397,464172	229,476242	1916,9871	49,979145	-95,199364
2635	24-06-2021 14:09:30000	1261,6068	400,618256	1323,6868	397,306976	229,385483	1925,1097	49,960854	-95,310074
2636	24-06-2021 14:09:35000	1256,887	406,118256	1320,8698	397,308868	229,386597	1921,001	49,959248	-95,156013

2637	24-06-2021 14:09:40000	1258,1482	404,826141	1321,6736	397,516022	229,50618	1921,194	49,960663	-95,193565
2638	24-06-2021 14:09:45000	1253,2317	402,543732	1316,2944	397,815186	229,678894	1911,9235	49,977947	-95,209068
2639	24-06-2021 14:09:50000	1247,1282	413,172241	1313,7886	397,34201	229,405701	1910,5674	50,013901	-94,926109
2640	24-06-2021 14:09:55000	1261,869	405,43045	1325,4009	397,286163	229,373474	1927,7273	50,006058	-95,206596
2641	24-06-2021 14:10:00000	1261,3005	399,941193	1323,1901	397,318146	229,391953	1924,3718	49,985901	-95,322701
2642	24-06-2021 14:10:05000	1265,1376	401,7258	1327,3871	397,23642	229,344757	1930,7462	49,959023	-95,310364
2643	24-06-2021 14:10:10000	1260,8477	395,359924	1321,3804	397,5867	229,547012	1920,3336	49,949318	-95,418976
2644	24-06-2021 14:10:15000	1253,4918	401,973022	1316,3677	397,641571	229,578674	1912,9014	49,97057	-95,223526
2645	24-06-2021 14:10:20000	1256,6383	412,562836	1322,6292	397,500885	229,497452	1922,5796	49,980526	-95,010628
2646	24-06-2021 14:10:25000	1261,1528	403,137939	1324,019	397,291107	229,376343	1925,6589	49,980705	-95,251862
2647	24-06-2021 14:10:30000	1263,1859	397,282867	1324,1875	397,2995	229,38118	1925,964	49,963181	-95,393288
2648	24-06-2021 14:10:35000	1263,6982	403,311707	1326,4967	396,946594	229,177444	1930,8907	49,938648	-95,265839
2649	24-06-2021 14:10:40000	1256,074	413,4729	1322,3773	397,423309	229,452652	1922,7264	49,934925	-94,986053
2650	24-06-2021 14:10:45000	1252,965	397,820251	1314,6035	397,164398	229,303192	1912,6029	49,949398	-95,311249
2651	24-06-2021 14:10:50000	1259,0702	405,914978	1322,885	396,849396	229,121292	1926,1742	49,949898	-95,176086
2652	24-06-2021 14:10:55000	1256,3544	397,970795	1317,8799	397,461792	229,474884	1915,9718	49,952946	-95,33149
2653	24-06-2021 14:11:00000	1262,1223	403,445862	1325,0364	397,451355	229,468842	1926,386	49,94519	-95,2519
2654	24-06-2021 14:11:05000	1259,1974	399,457275	1321,0391	397,854218	229,701447	1918,6434	49,940655	-95,31871
2655	24-06-2021 14:11:10000	1259,9962	412,629822	1325,8407	397,704468	229,61499	1926,348	49,944225	-95,033745
2656	24-06-2021 14:11:15000	1249,1333	401,230865	1311,9908	398,342651	229,983429	1903,1624	49,977058	-95,208992
2657	24-06-2021 14:11:20000	1260,2056	405,986694	1323,9877	397,284637	229,372589	1925,5972	49,971645	-95,182579
2658	24-06-2021 14:11:25000	1266,3654	400,042633	1328,0494	397,358948	229,415512	1931,2478	49,940674	-95,355286
2659	24-06-2021 14:11:30000	1253,3433	411,852692	1319,277	398,360657	229,993835	1913,6826	49,958141	-95,002281
2660	24-06-2021 14:11:35000	1254,8643	406,823212	1319,1625	397,848083	229,697906	1915,9116	49,968174	-95,125839
2661	24-06-2021 14:11:40000	1263,1509	401,547333	1325,4397	397,555634	229,529068	1926,4625	49,960251	-95,300514
2662	24-06-2021 14:11:45000	1264,6089	397,707703	1325,6722	397,584259	229,545578	1926,6342	49,932339	-95,393776
2663	24-06-2021 14:11:50000	1257,8975	404,982086	1321,4827	397,820221	229,681808	1919,3777	49,929287	-95,188339
2664	24-06-2021 14:11:55000	1255,9204	406,516022	1320,0724	397,811127	229,676559	1917,55	49,940411	-95,140259
2665	24-06-2021 14:12:00000	1257,2369	404,559784	1320,7245	397,854828	229,701797	1918,1432	49,942776	-95,19297
2666	24-06-2021 14:12:05000	1258,0808	403,657684	1321,252	397,913391	229,735596	1918,7622	49,951786	-95,218842

2667	24-06-2021 14:12:10000	1255,8632	403,263153	1319,0198	397,678101	229,599777	1916,5328	49,956684	-95,211845
2668	24-06-2021 14:12:15000	1260,0696	404,216309	1323,3164	397,686981	229,604889	1922,8335	49,947746	-95,220589
2669	24-06-2021 14:12:20000	1265,2938	403,303864	1328,0145	397,622131	229,567444	1929,9041	49,917583	-95,277107
2670	24-06-2021 14:12:25000	1259,4951	399,221619	1321,2516	397,747375	229,639755	1919,5288	49,898487	-95,325905
2671	24-06-2021 14:12:30000	1254,7279	404,887665	1318,437	397,903015	229,729614	1914,6387	49,910362	-95,167831
2672	24-06-2021 14:12:35000	1256,9153	408,529083	1321,64	397,708649	229,617401	1920,2257	49,920326	-95,102707
2673	24-06-2021 14:12:40000	1256,7584	401,102112	1319,2136	397,769928	229,652786	1916,3868	49,932884	-95,265724
2674	24-06-2021 14:12:45000	1260,0436	403,09549	1322,9497	397,582672	229,544678	1922,6752	49,940945	-95,24501
2675	24-06-2021 14:12:50000	1256,7109	405,402985	1320,4824	397,70285	229,614059	1918,5226	49,944275	-95,170586
2676	24-06-2021 14:12:55000	1250,7972	406,905182	1315,3196	397,978302	229,773087	1909,7412	49,966797	-95,094551
2677	24-06-2021 14:13:00000	1262,4297	398,466248	1323,8218	397,500946	229,497498	1924,3516	49,964005	-95,362511
2678	24-06-2021 14:13:05000	1263,4501	397,73877	1324,5762	397,617126	229,56456	1924,9266	49,943649	-95,385231
2679	24-06-2021 14:13:10000	1256,6343	402,751648	1319,5979	397,869019	229,709991	1916,464	49,951439	-95,228577
2680	24-06-2021 14:13:15000	1255,7911	408,264557	1320,489	397,601288	229,55542	1919,0496	49,963562	-95,100456
2681	24-06-2021 14:13:20000	1260,5026	405,503235	1324,1223	397,63446	229,574554	1924,137	49,965252	-95,195335
2682	24-06-2021 14:13:25000	1267,1954	397,217957	1327,9933	397,525818	229,511841	1930,3314	49,925175	-95,421822
2683	24-06-2021 14:13:30000	1257,5513	409,49469	1322,5435	397,825989	229,685135	1920,9462	49,919903	-95,085823
2684	24-06-2021 14:13:35000	1255,2211	402,19635	1318,0826	397,782654	229,660126	1914,6554	49,928333	-95,230835
2685	24-06-2021 14:13:40000	1258,4368	403,65918	1321,5914	397,68692	229,604858	1920,2061	49,931038	-95,221321
2686	24-06-2021 14:13:45000	1259,3544	396,592865	1320,3256	397,65741	229,587814	1918,5759	49,935017	-95,382118
2687	24-06-2021 14:13:50000	1259,3068	402,41806	1322,0415	397,611084	229,561066	1921,1453	49,934994	-95,254707
2688	24-06-2021 14:13:55000	1256,7417	408,115906	1321,3472	397,526093	229,511993	1920,635	49,936722	-95,110641
2689	24-06-2021 14:14:00000	1255,8586	409,313019	1320,8777	397,763885	229,649277	1918,8436	49,944126	-95,077583
2690	24-06-2021 14:14:05000	1262,1293	402,132019	1324,6436	397,499969	229,496918	1925,5562	49,936844	-95,28067
2691	24-06-2021 14:14:10000	1257,9871	406,811798	1322,1298	397,59845	229,553772	1921,48	49,931629	-95,148529
2692	24-06-2021 14:14:15000	1266,3274	407,991241	1330,4292	397,201965	229,324875	1935,4036	49,902969	-95,18187
2693	24-06-2021 14:14:20000	1268,3982	401,626282	1330,4652	397,36792	229,420685	1934,7405	49,866684	-95,334938
2694	24-06-2021 14:14:25000	1256,7142	402,93573	1319,7302	397,797394	229,668625	1917,0929	49,877182	-95,225082
2695	24-06-2021 14:14:30000	1248,3835	401,963806	1311,5015	398,102142	229,844574	1903,672	49,919781	-95,187347
2696	24-06-2021 14:14:35000	1247,8085	405,944794	1312,1804	397,81311	229,677704	1906,0033	49,953091	-95,094284

2697	24-06-2021 14:14:40000	1260,6674	402,114044	1323,2452	397,269165	229,363663	1924,7037	49,940903	-95,270882
2698	24-06-2021 14:14:45000	1263,1687	405,513824	1326,6638	397,661255	229,590042	1927,7723	49,929382	-95,213936
2699	24-06-2021 14:14:50000	1265,2076	401,323395	1327,3322	397,624542	229,568832	1928,9398	49,914577	-95,319588
2700	24-06-2021 14:14:55000	1261,9568	400,306488	1323,926	397,973938	229,770569	1922,3002	49,9081	-95,319283
2701	24-06-2021 14:15:00000	1258,6323	408,545227	1323,2781	397,823578	229,683746	1922,064	49,90966	-95,114738
2702	24-06-2021 14:15:05000	1261,3137	399,250305	1322,9939	397,59491	229,551743	1922,7667	49,902603	-95,33783
2703	24-06-2021 14:15:10000	1255,7708	404,583984	1319,3362	397,907745	229,732346	1915,9668	49,91246	-95,181999
2704	24-06-2021 14:15:15000	1256,4546	406,44104	1320,5576	397,614746	229,563187	1919,1865	49,924374	-95,14576
2705	24-06-2021 14:15:20000	1258,7311	406,393005	1322,709	397,687378	229,605103	1921,9957	49,938889	-95,163109
2706	24-06-2021 14:15:25000	1258,8801	403,670776	1322,0172	397,473053	229,481369	1921,9225	49,94207	-95,22419
2707	24-06-2021 14:15:30000	1267,3709	405,972931	1330,8053	397,219238	229,334839	1935,9742	49,910267	-95,233376
2708	24-06-2021 14:15:35000	1264,7505	398,072296	1325,9167	397,515045	229,50563	1927,4049	49,878555	-95,386864
2709	24-06-2021 14:15:40000	1261,7262	404,543274	1324,9938	397,786926	229,662598	1924,7975	49,875031	-95,225075
2710	24-06-2021 14:15:45000	1259,8883	407,928467	1324,2825	397,522095	229,509689	1925,1189	49,876617	-95,137428
2711	24-06-2021 14:15:50000	1257,4084	398,239105	1318,9657	397,53772	229,518707	1917,2046	49,874859	-95,332916
2712	24-06-2021 14:15:55000	1252,0157	406,014679	1316,2034	398,05957	229,819992	1910,6617	49,894348	-95,123276
2713	24-06-2021 14:16:00000	1248,9098	399,406952	1311,2214	398,153961	229,874496	1902,9318	49,935181	-95,247818
2714	24-06-2021 14:16:05000	1259,4572	402,814941	1322,3055	397,73407	229,63208	1921,077	49,94133	-95,247055
2715	24-06-2021 14:16:10000	1259,3562	411,521942	1324,8879	397,61615	229,564011	1925,3595	49,936981	-95,05378
2716	24-06-2021 14:16:15000	1265,2183	399,828918	1326,8914	397,586365	229,546799	1928,4406	49,91806	-95,352066
2717	24-06-2021 14:16:20000	1265,3887	410,01947	1330,1595	397,415649	229,448242	1934,0167	49,884762	-95,130592
2718	24-06-2021 14:16:25000	1260,7531	394,149323	1320,9285	397,614105	229,562836	1919,7047	49,879025	-95,444466
2719	24-06-2021 14:16:30000	1252,7773	405,267822	1316,6979	397,970398	229,768509	1911,8718	49,902523	-95,145401
2720	24-06-2021 14:16:35000	1249,1635	405,220154	1313,2451	398,048126	229,8134	1906,3998	49,94672	-95,120361
2721	24-06-2021 14:16:40000	1254,8829	403,390533	1318,1256	397,831482	229,688309	1914,5309	49,961086	-95,202072
2722	24-06-2021 14:16:45000	1260,733	399,432281	1322,4954	397,764771	229,649796	1921,1593	49,950905	-95,329865
2723	24-06-2021 14:16:50000	1266,6547	402,475861	1329,0602	397,352753	229,411926	1932,7035	49,935108	-95,304543
2724	24-06-2021 14:16:55000	1265,6884	404,781189	1328,8397	397,606323	229,558319	1931,2931	49,900997	-95,247635
2725	24-06-2021 14:17:00000	1263,2766	411,689911	1328,6672	397,784729	229,661331	1930,1125	49,883102	-95,078484
2726	24-06-2021 14:17:05000	1253,6249	396,983337	1314,9795	397,947601	229,755356	1909,3984	49,892941	-95,334175



2727	24-06-2021 14:17:10000	1246,21	411,994385	1312,5466	397,989349	229,779465	1905,7218	49,930542	-94,945961
2728	24-06-2021 14:17:15000	1264,7891	400,084351	1326,5591	397,27417	229,366547	1929,4319	49,919643	-95,343597
2729	24-06-2021 14:17:20000	1264,6058	405,620544	1328,0647	397,391907	229,43454	1931,1398	49,906433	-95,221703
2730	24-06-2021 14:17:25000	1268,3829	407,191559	1332,1412	397,295441	229,378845	1937,527	49,871807	-95,213852
2731	24-06-2021 14:17:30000	1257,7323	406,288513	1321,7266	397,977448	229,772598	1919,0492	49,868774	-95,158287
2732	24-06-2021 14:17:35000	1250,2032	405,460907	1314,3085	397,872192	229,711823	1908,7659	49,912083	-95,122513
2733	24-06-2021 14:17:40000	1256,7792	410,495758	1322,1199	397,669495	229,594803	1921,069	49,927963	-95,057892
2734	24-06-2021 14:17:45000	1262,0785	405,923615	1325,7511	397,574646	229,540039	1926,8457	49,914963	-95,197243
2735	24-06-2021 14:17:50000	1257,6639	404,656525	1321,1606	397,518921	229,507858	1920,4346	49,91312	-95,193871
2736	24-06-2021 14:17:55000	1261,9363	405,101807	1325,3644	397,495514	229,494354	1926,5966	49,901772	-95,214294
2737	24-06-2021 14:18:00000	1259,0527	407,511047	1323,359	397,654449	229,586121	1922,9763	49,904133	-95,140678
2738	24-06-2021 14:18:05000	1248,0104	396,935608	1309,6135	397,935547	229,748398	1901,728	49,928902	-95,296074
2739	24-06-2021 14:18:10000	1258,2543	400,985901	1320,6035	397,686737	229,604752	1918,801	49,935791	-95,278732
2740	24-06-2021 14:18:15000	1263,0385	408,313599	1327,3983	397,529724	229,514099	1929,4916	49,91338	-95,151428
2741	24-06-2021 14:18:20000	1268,5216	401,831604	1330,6448	397,330048	229,398834	1935,1072	49,87978	-95,331345
2742	24-06-2021 14:18:25000	1257,8447	405,363342	1321,5494	397,923981	229,74173	1919,0365	49,883579	-95,17955
2743	24-06-2021 14:18:30000	1247,5696	392,385559	1307,8212	398,391937	230,011887	1896,9558	49,92794	-95,392975
2744	24-06-2021 14:18:35000	1244,2046	404,862183	1308,4183	398,303833	229,961029	1898,2268	50	-95,092262
2745	24-06-2021 14:18:40000	1266,5814	408,305908	1330,7675	397,166351	229,304291	1936,1215	49,978718	-95,176758
2746	24-06-2021 14:18:45000	1271,7459	406,11322	1335,0153	397,591492	229,549774	1940,1886	49,931423	-95,26078
2747	24-06-2021 14:18:50000	1261,9677	403,860809	1325,0154	397,929962	229,745178	1924,1184	49,911816	-95,24173
2748	24-06-2021 14:18:55000	1260,4554	399,905426	1322,3738	397,979034	229,773499	1920,0795	49,905319	-95,317642
2749	24-06-2021 14:19:00000	1255,4464	409,695679	1320,6046	398,184479	229,892105	1916,4912	49,915478	-95,06604
2750	24-06-2021 14:19:05000	1254,1875	402,424591	1317,1681	398,147461	229,870758	1911,6619	49,930038	-95,218483
2751	24-06-2021 14:19:10000	1249,6375	402,76123	1312,9396	398,387329	230,009232	1904,3663	49,963982	-95,178596
2752	24-06-2021 14:19:15000	1256,772	403,759186	1320,0369	397,902252	229,729172	1916,9751	49,968246	-95,207336
2753	24-06-2021 14:19:20000	1259,527	405,498688	1323,1921	398,009705	229,791214	1921,062	49,963902	-95,188515
2754	24-06-2021 14:19:25000	1261,1542	406,323547	1324,9938	398,089722	229,837418	1923,224	49,957264	-95,181892
2755	24-06-2021 14:19:30000	1268,6024	405,512512	1331,838	397,826965	229,685715	1934,3792	49,921944	-95,252007
2756	24-06-2021 14:19:35000	1260,2433	404,952942	1323,7069	398,093506	229,839615	1921,3373	49,906116	-95,205612

2757	24-06-2021 14:19:40000	1256,6421	404,899567	1320,2626	398,282166	229,948532	1915,5197	49,914185	-95,181229
2758	24-06-2021 14:19:45000	1259,1892	397,081238	1320,3148	398,115784	229,852463	1916,3728	49,921238	-95,370384
2759	24-06-2021 14:19:50000	1253,8334	405,772552	1317,8579	398,186371	229,893219	1912,415	49,931107	-95,141769
2760	24-06-2021 14:19:55000	1259,5271	404,863983	1322,9979	397,882935	229,718018	1921,4071	49,928864	-95,202507
2761	24-06-2021 14:20:00000	1258,9987	401,110596	1321,3505	397,968048	229,767181	1918,4825	49,922745	-95,281197
2762	24-06-2021 14:20:05000	1261,7195	404,980347	1325,1207	398,07666	229,829865	1923,4404	49,915031	-95,215431
2763	24-06-2021 14:20:10000	1252,6836	400,165497	1315,047	398,31781	229,969101	1907,676	49,935043	-95,257706
2764	24-06-2021 14:20:15000	1260,8977	405,128296	1324,3837	398,035858	229,806335	1922,7057	49,932568	-95,206383
2765	24-06-2021 14:20:20000	1255,0754	407,236816	1319,4908	398,451172	230,046097	1913,5409	49,946259	-95,118156
2766	24-06-2021 14:20:25000	1260,8446	399,041473	1322,4838	397,986877	229,778046	1920,0955	49,951408	-95,339142
2767	24-06-2021 14:20:30000	1270,8242	405,36438	1333,9094	397,707031	229,61647	1937,9871	49,905724	-95,270653
2768	24-06-2021 14:20:35000	1265,1307	403,888947	1328,037	398,200134	229,901154	1927,1388	49,890919	-95,263222
2769	24-06-2021 14:20:40000	1254,462	405,694641	1318,4321	398,415955	230,025757	1912,2247	49,911522	-95,148018
2770	24-06-2021 14:20:45000	1259,0215	406,54715	1323,0328	398,162811	229,879623	1920,1625	49,901363	-95,161774
2771	24-06-2021 14:20:50000	1259,0521	396,939789	1320,1415	398,217865	229,911392	1915,5928	49,900375	-95,372513
2772	24-06-2021 14:20:55000	1251,1359	404,839783	1315,0043	398,676361	230,176117	1905,9863	49,935741	-95,143105
2773	24-06-2021 14:21:00000	1259,2152	404,066101	1322,457	398,179047	229,888992	1919,1843	49,948372	-95,217865
2774	24-06-2021 14:21:05000	1258,9214	404,214081	1322,2224	398,299805	229,958694	1918,2098	49,946293	-95,212532
2775	24-06-2021 14:21:10000	1259,2682	402,912476	1322,1554	398,528809	230,090927	1917,0925	49,96233	-95,243584
2776	24-06-2021 14:21:15000	1260,5413	409,691956	1325,4479	398,199493	229,900787	1923,3829	49,965248	-95,10305
2777	24-06-2021 14:21:20000	1262,1348	408,321716	1326,5409	398,346558	229,985703	1924,2996	49,944839	-95,144806
2778	24-06-2021 14:21:25000	1257,4983	403,489807	1320,646	398,486511	230,066498	1915,0853	49,945328	-95,218422
2779	24-06-2021 14:21:30000	1253,2136	404,888092	1316,9961	398,50647	230,078018	1909,7473	49,957359	-95,156975
2780	24-06-2021 14:21:35000	1263,1187	404,212677	1326,2189	398,297363	229,957291	1924,0272	49,954834	-95,242096
2781	24-06-2021 14:21:40000	1257,0713	404,307281	1320,4895	398,547028	230,10144	1914,5745	49,955853	-95,197365
2782	24-06-2021 14:21:45000	1258,8279	406,227264	1322,7501	398,37851	230,00415	1918,6334	49,960861	-95,167465
2783	24-06-2021 14:21:50000	1261,4413	404,651642	1324,7555	398,259216	229,935272	1922,1158	49,952213	-95,220688
2784	24-06-2021 14:21:55000	1265,1656	407,821777	1329,2714	398,013672	229,793503	1929,9739	49,923893	-95,177368
2785	24-06-2021 14:22:00000	1261,6948	398,369354	1323,0918	399,565338	230,689377	1914,3911	49,898186	-95,359581
2786	24-06-2021 14:22:05000	1253,7283	388,797791	1312,6302	399,949432	230,911133	1897,4932	49,921268	-95,512672

2787	24-06-2021 14:22:10000	1254,741	402,317017	1317,6622	399,684845	230,758362	1905,978	49,94315	-95,224777
2788	24-06-2021 14:22:15000	1262,3851	400,815002	1324,4882	399,062012	230,398773	1918,8092	49,934258	-95,311165
2789	24-06-2021 14:22:20000	1259,726	391,387115	1319,126	399,31073	230,542374	1909,8676	49,918381	-95,497017
2790	24-06-2021 14:22:25000	1255,9669	391,539246	1315,582	399,735992	230,787903	1902,8312	49,919487	-95,468544
2791	24-06-2021 14:22:30000	1250,359	394,095062	1310,9952	399,928253	230,89888	1895,2246	49,96262	-95,374794
2792	24-06-2021 14:22:35000	1252,3406	400,367065	1314,7816	399,63623	230,730301	1902,0184	49,988777	-95,250839
2793	24-06-2021 14:22:40000	1260,4144	402,37384	1323,0831	399,291595	230,531311	1915,772	49,969997	-95,263428
2794	24-06-2021 14:22:45000	1260,5021	395,822784	1321,1893	399,409668	230,599487	1912,3751	49,963413	-95,406624
2795	24-06-2021 14:22:50000	1255,6432	394,243347	1316,0804	399,574585	230,694702	1904,1804	49,968128	-95,407784
2796	24-06-2021 14:22:55000	1267,24	399,216492	1328,635	398,622314	230,144913	1926,9463	49,938816	-95,379089
2797	24-06-2021 14:23:00000	1270,7173	402,033051	1332,799	398,829987	230,264816	1932,0562	49,880791	-95,34201
2798	24-06-2021 14:23:05000	1257,9408	389,842926	1316,9634	399,205841	230,481812	1907,2279	49,875702	-95,51828
2799	24-06-2021 14:23:10000	1253,3568	396,867004	1314,6887	399,236969	230,499771	1903,8367	49,89439	-95,334862
2800	24-06-2021 14:23:15000	1253,5559	393,501709	1313,8667	399,203247	230,480316	1902,8483	49,915489	-95,40966
2801	24-06-2021 14:23:20000	1253,5065	397,879761	1315,1376	399,261841	230,51413	1904,4229	49,940109	-95,313713
2802	24-06-2021 14:23:25000	1255,9026	401,191833	1318,4257	399,376373	230,580261	1908,587	49,943413	-95,257751
2803	24-06-2021 14:23:30000	1258,7402	390,905609	1318,0417	398,979858	230,351349	1909,9113	49,935459	-95,500786
2804	24-06-2021 14:23:35000	1265,4498	395,076202	1325,6879	399,154846	230,452377	1920,1599	49,90604	-95,456085
2805	24-06-2021 14:23:40000	1266,8049	396,055511	1327,2734	398,814575	230,25592	1924,0665	49,882938	-95,44416
2806	24-06-2021 14:23:45000	1257,2677	394,447662	1317,6915	399,4151	230,602631	1907,4304	49,876949	-95,414413
2807	24-06-2021 14:23:50000	1251,8661	401,069366	1314,5438	399,518494	230,662308	1902,3378	49,91433	-95,231979
2808	24-06-2021 14:23:55000	1247,5558	393,717438	1308,2083	399,248779	230,506592	1894,4585	49,959095	-95,363701
2809	24-06-2021 14:24:00000	1263,1489	395,710327	1323,6813	399,283203	230,526474	1916,5631	49,958862	-95,426979
2810	24-06-2021 14:24:05000	1261,3204	398,592407	1322,802	399,230988	230,496323	1915,5392	49,948341	-95,352173
2811	24-06-2021 14:24:10000	1266,1658	397,41925	1327,0712	399,440002	230,617004	1920,76	49,927017	-95,410545
2812	24-06-2021 14:24:15000	1266,6935	396,628021	1327,338	399,395447	230,591278	1921,5161	49,908768	-95,431114
2813	24-06-2021 14:24:20000	1267,448	403,002563	1329,9757	399,087585	230,413544	1926,6539	49,879421	-95,298576
2814	24-06-2021 14:24:25000	1254,2531	400,075958	1316,5149	399,645294	230,735519	1904,6024	49,88435	-95,270706
2815	24-06-2021 14:24:30000	1253,1031	397,222931	1314,5546	399,763855	230,80397	1901,1829	49,91256	-95,32531
2816	24-06-2021 14:24:35000	1257,9308	401,359283	1320,4087	399,200867	230,478928	1912,2924	49,923733	-95,268288

2817	24-06-2021 14:24:40000	1260,4229	393,680817	1320,4736	399,236328	230,499405	1912,328	49,924114	-95,452339
2818	24-06-2021 14:24:45000	1259,2362	395,668854	1319,9355	399,217804	230,488708	1911,4783	49,917522	-95,401344
2819	24-06-2021 14:24:50000	1251,7472	398,698975	1313,7094	399,5466	230,678528	1901,0677	49,935627	-95,283432
2820	24-06-2021 14:24:55000	1259,9779	394,523804	1320,3005	399,169708	230,460953	1912,3342	49,928909	-95,431145
2821	24-06-2021 14:25:00000	1258,4393	390,369568	1317,5956	399,634369	230,729218	1906,2982	49,926357	-95,510292
2822	24-06-2021 14:25:05000	1256,3777	395,400452	1317,1281	399,596466	230,707336	1905,863	49,940853	-95,387665
2823	24-06-2021 14:25:10000	1259,4229	398,974731	1321,1082	399,132751	230,43959	1913,8372	49,942898	-95,330788
2824	24-06-2021 14:25:15000	1265,155	402,432373	1327,6178	399,104462	230,423264	1923,2485	49,916439	-95,29512
2825	24-06-2021 14:25:20000	1270,4363	396,148346	1330,7675	399,245087	230,504456	1927,2227	49,872372	-95,466438
2826	24-06-2021 14:25:25000	1261,2992	388,692413	1319,8323	399,447723	230,62146	1910,4534	49,858021	-95,565109
2827	24-06-2021 14:25:30000	1249,3447	404,356567	1313,1514	399,553253	230,682373	1900,3472	49,889812	-95,140953
2828	24-06-2021 14:25:35000	1254,7192	396,818726	1315,9731	399,434967	230,61409	1904,8256	49,911896	-95,345352
2829	24-06-2021 14:25:40000	1262,7716	395,678314	1323,3115	399,020203	230,374619	1917,4463	49,891884	-95,425117
2830	24-06-2021 14:25:45000	1266,3153	390,489655	1325,1553	399,201233	230,479141	1919,283	49,873001	-95,559769
2831	24-06-2021 14:25:50000	1251,3842	400,039001	1313,7709	399,529907	230,6689	1901,2636	49,906448	-95,251335
2832	24-06-2021 14:25:55000	1252,2114	384,119019	1309,8018	399,487274	230,644287	1895,6534	49,926567	-95,603119
2833	24-06-2021 14:26:00000	1260,5234	397,654236	1321,7595	399,144043	230,446136	1914,5554	49,921398	-95,367081
2834	24-06-2021 14:26:05000	1259,8101	397,592377	1321,0605	399,284668	230,527313	1912,9674	49,910313	-95,363533
2835	24-06-2021 14:26:10000	1263,3977	394,806824	1323,6488	398,965454	230,343033	1918,1624	49,899307	-95,448105
2836	24-06-2021 14:26:15000	1254,6764	401,72345	1317,4196	398,471771	230,057968	1910,7592	49,91774	-95,237411
2837	24-06-2021 14:26:20000	1257,2841	405,799133	1321,1495	398,038727	229,807953	1918,0557	49,917706	-95,165916
2838	24-06-2021 14:26:25000	1254,2771	410,409943	1319,7148	397,797089	229,668442	1917,1763	49,92461	-95,041519
2839	24-06-2021 14:26:30000	1254,6449	397,930786	1316,238	398,017151	229,795517	1910,9807	49,935997	-95,320511
2840	24-06-2021 14:26:35000	1259,9838	403,744293	1323,0905	397,67099	229,595642	1922,5924	49,9324	-95,230354
2841	24-06-2021 14:26:40000	1259,9988	415,165436	1326,6345	397,591827	229,549927	1928,2234	49,916306	-94,977081
2842	24-06-2021 14:26:45000	1258,4868	395,479523	1319,1637	397,501953	229,498047	1917,7871	49,909733	-95,400345
2843	24-06-2021 14:26:50000	1259,2915	402,704926	1322,1143	397,737518	229,634048	1921,0182	49,905651	-95,248306
2844	24-06-2021 14:26:55000	1264,9828	407,013672	1328,8497	397,0448	229,234116	1934,0712	49,883778	-95,193817
2845	24-06-2021 14:27:00000	1263,0254	408,995941	1327,5959	397,203156	229,325546	1931,5369	49,853439	-95,136284
2846	24-06-2021 14:27:05000	1252,1661	394,069702	1312,7113	397,512238	229,503983	1908,3788	49,886105	-95,387779

2847	24-06-2021 14:27:10000	1251,6964	403,459442	1315,1135	397,621124	229,566849	1911,2499	49,91069	-95,177826
2848	24-06-2021 14:27:15000	1259,2861	410,518097	1324,51	397,500824	229,497406	1925,4635	49,915794	-95,075623
2849	24-06-2021 14:27:20000	1258,046	405,798676	1321,8745	397,826019	229,68515	1920,0861	49,907391	-95,171364
2850	24-06-2021 14:27:25000	1255,8975	403,5784	1319,1488	398,064423	229,822784	1915,1003	49,917942	-95,205132
2851	24-06-2021 14:27:30000	1257,0295	401,961761	1319,7335	397,90332	229,729782	1916,7025	49,926994	-95,248741
2852	24-06-2021 14:27:35000	1260,1642	405,41153	1323,772	397,489594	229,490921	1924,5134	49,921329	-95,194954
2853	24-06-2021 14:27:40000	1255,5184	413,232361	1321,7743	397,975128	229,771225	1919,2419	49,937611	-94,98735
2854	24-06-2021 14:27:45000	1267,6133	407,297852	1331,4409	397,566345	229,535233	1935,2925	49,90197	-95,206123
2855	24-06-2021 14:27:50000	1258,7958	399,191162	1320,5758	397,843719	229,695389	1918,2491	49,900394	-95,321739
2856	24-06-2021 14:27:55000	1256,1869	409,518921	1321,2537	397,918152	229,738342	1918,801	49,912689	-95,075378
2857	24-06-2021 14:28:00000	1259,7311	402,815948	1322,5668	397,693634	229,608704	1921,8357	49,908752	-95,248955
2858	24-06-2021 14:28:05000	1257,3059	404,635712	1320,8135	397,925293	229,742462	1918,0814	49,920418	-95,191788
2859	24-06-2021 14:28:10000	1252,7922	397,69931	1314,4022	398,026154	229,800705	1908,3195	49,945995	-95,312698
2860	24-06-2021 14:28:15000	1261,682	396,209869	1322,4309	397,504883	229,499756	1922,4384	49,94389	-95,406265
2861	24-06-2021 14:28:20000	1267,2983	409,27005	1331,7459	397,354004	229,412628	1936,7269	49,911652	-95,160675
2862	24-06-2021 14:28:25000	1264,5361	405,694122	1328,0208	397,701813	229,613449	1929,672	49,889095	-95,219597
2863	24-06-2021 14:28:30000	1256,6581	408,87619	1321,5027	397,811218	229,676605	1919,6942	49,904591	-95,093117
2864	24-06-2021 14:28:35000	1253,4832	397,469452	1314,9912	397,897339	229,726334	1909,8243	49,918873	-95,322548
2865	24-06-2021 14:28:40000	1254,6754	403,834259	1318,064	398,066681	229,824097	1913,5009	49,932739	-95,190788
2866	24-06-2021 14:28:45000	1259,1285	402,267975	1321,8261	397,8078	229,674637	1920,1479	49,935528	-95,256744
2867	24-06-2021 14:28:50000	1256,3176	407,552216	1320,7698	398,000916	229,786118	1917,7007	49,941021	-95,12011
2868	24-06-2021 14:28:55000	1258,0895	409,470551	1323,0476	397,637177	229,576111	1922,7837	49,940453	-95,090256
2869	24-06-2021 14:29:00000	1263,1769	405,497131	1326,6664	397,655426	229,58667	1927,8998	49,921806	-95,214355
2870	24-06-2021 14:29:05000	1270,0378	402,894104	1332,4113	397,20166	229,324692	1938,4207	49,881187	-95,318756
2871	24-06-2021 14:29:10000	1256,943	404,581635	1320,4514	397,899658	229,727676	1917,7902	49,887341	-95,190399
2872	24-06-2021 14:29:15000	1257,0642	403,047424	1320,0975	397,796722	229,668228	1917,6757	49,905945	-95,225098
2873	24-06-2021 14:29:20000	1248,5653	410,861511	1314,4286	398,134979	229,863525	1907,8833	49,947918	-94,989204
2874	24-06-2021 14:29:25000	1260,5758	405,339142	1324,1416	397,259216	229,35791	1926,155	49,946796	-95,199463
2875	24-06-2021 14:29:30000	1269,8153	404,970001	1332,8284	397,356598	229,414139	1938,2831	49,905624	-95,272224
2876	24-06-2021 14:29:35000	1265,8616	402,983124	1328,4581	397,673096	229,596863	1930,4358	49,883999	-95,288033

2877	24-06-2021 14:29:40000	1254,3029	399,91687	1316,5139	398,110046	229,849136	1910,9572	49,903522	-95,274551
2878	24-06-2021 14:29:45000	1250,9755	403,103546	1314,318	397,924683	229,742126	1908,7076	49,927193	-95,180573
2879	24-06-2021 14:29:50000	1256,8389	405,946564	1320,7712	397,743317	229,637405	1918,8602	49,938362	-95,15947
2880	24-06-2021 14:29:55000	1257,6844	406,6138	1321,781	397,706299	229,616028	1920,585	49,945114	-95,150749
2881	24-06-2021 14:30:00000	1265,8301	398,403168	1327,0459	397,370178	229,421967	1929,8051	49,923683	-95,387062
2882	24-06-2021 14:30:05000	1264,6785	407,780518	1328,7952	397,61731	229,564667	1931,1472	49,898415	-95,174828
2883	24-06-2021 14:30:10000	1256,1808	397,086426	1317,4474	398,030273	229,803085	1912,6958	49,906197	-95,349594
2884	24-06-2021 14:30:15000	1254,6685	408,019684	1319,3456	397,766602	229,650848	1916,717	49,920162	-95,097778
2885	24-06-2021 14:30:20000	1262,0951	404,371124	1325,2924	397,791809	229,665405	1925,2299	49,917	-95,231438
2886	24-06-2021 14:30:25000	1253,5314	406,493988	1317,793	398,067383	229,824509	1913,0815	49,924175	-95,123543
2887	24-06-2021 14:30:30000	1255,9009	400,021179	1318,0682	397,878906	229,715683	1914,2113	49,945919	-95,283447
2888	24-06-2021 14:30:35000	1261,8411	410,375427	1326,8951	397,310211	229,38736	1929,7656	49,939548	-95,097267
2889	24-06-2021 14:30:40000	1271,7766	405,29126	1334,7947	397,176056	229,309921	1941,9265	49,884731	-95,278824
2890	24-06-2021 14:30:45000	1260,8792	394,727997	1321,2216	397,895355	229,725189	1918,7903	49,876575	-95,432831
2891	24-06-2021 14:30:50000	1252,9463	404,473938	1316,6145	398,123016	229,856628	1911,0267	49,88279	-95,164253
2892	24-06-2021 14:30:55000	1252,0637	404,50415	1315,7838	397,718842	229,62326	1911,8304	49,92247	-95,157249
2893	24-06-2021 14:31:00000	1257,1563	402,51181	1320,0217	397,305084	229,384399	1919,9099	49,925045	-95,237534
2894	24-06-2021 14:31:05000	1258,3336	404,431091	1321,7292	397,362183	229,417358	1922,0735	49,916927	-95,20359
2895	24-06-2021 14:31:10000	1250,2391	407,598602	1315,0035	398,437286	230,038071	1907,1364	49,951653	-95,074959
2896	24-06-2021 14:31:15000	1256,7037	403,39859	1319,8616	397,864349	229,707291	1917,0443	49,965832	-95,214813
2897	24-06-2021 14:31:20000	1265,5438	407,068726	1329,4008	397,381622	229,428574	1933,1659	49,931381	-95,196571
2898	24-06-2021 14:31:25000	1264,2979	398,730804	1325,683	397,862946	229,706482	1925,4827	49,911129	-95,369553
2899	24-06-2021 14:31:30000	1252,8319	408,11557	1317,6289	398,270752	229,941925	1911,7588	49,922401	-95,082298
2900	24-06-2021 14:31:35000	1251,8207	406,367615	1316,1267	398,212769	229,908447	1909,823	49,945618	-95,113991
2901	24-06-2021 14:31:40000	1260,4226	399,621613	1322,2566	398,012665	229,792923	1919,6655	49,945595	-95,323601
2902	24-06-2021 14:31:45000	1261,0032	407,023956	1325,0652	398,000854	229,786118	1923,8137	49,932617	-95,165375
2903	24-06-2021 14:31:50000	1253,332	403,988617	1316,8325	398,204285	229,903549	1910,8756	49,948448	-95,17778
2904	24-06-2021 14:31:55000	1256,5432	404,585022	1320,072	398,351501	229,988541	1914,976	49,96624	-95,187485
2905	24-06-2021 14:32:00000	1253,9186	408,348297	1318,7344	398,117096	229,853195	1914,1492	49,98576	-95,085007
2906	24-06-2021 14:32:05000	1266,6602	400,546875	1328,4824	397,976044	229,771774	1928,9767	49,957333	-95,346397

2907	24-06-2021 14:32:10000	1265,1874	399,780487	1326,8472	398,126343	229,858551	1925,8057	49,921967	-95,352905
2908	24-06-2021 14:32:15000	1253,5116	403,456787	1316,8403	398,664368	230,169189	1908,7621	49,942318	-95,190849
2909	24-06-2021 14:32:20000	1253,585	408,555664	1318,4813	398,141174	229,867096	1913,6302	49,958485	-95,07795
2910	24-06-2021 14:32:25000	1260,6367	402,119049	1323,2177	397,975739	229,771606	1921,3231	49,954243	-95,270554
2911	24-06-2021 14:32:30000	1266,597	405,165924	1329,8223	397,270752	229,364578	1934,2488	49,923233	-95,245583
2912	24-06-2021 14:32:35000	1262,0646	401,319977	1324,3356	397,764221	229,649475	1923,988	49,89595	-95,297943
2913	24-06-2021 14:32:40000	1254,9441	409,18103	1319,9674	397,958038	229,761383	1916,641	49,914757	-95,073875
2914	24-06-2021 14:32:45000	1257,1155	404,852875	1320,6989	397,617828	229,564957	1919,4381	49,918579	-95,185631
2915	24-06-2021 14:32:50000	1262,7015	400,314301	1324,6384	397,556671	229,529648	1925,4023	49,910172	-95,324249
2916	24-06-2021 14:32:55000	1253,3906	409,476105	1318,5822	397,748627	229,640472	1915,6243	49,922268	-95,055939
2917	24-06-2021 14:33:00000	1260,434	406,897644	1324,4846	397,486633	229,489227	1925,4613	49,911995	-95,164108
2918	24-06-2021 14:33:05000	1261,8586	403,548645	1324,8165	397,728851	229,629059	1924,8918	49,893116	-95,247803
2919	24-06-2021 14:33:10000	1258,4334	403,171539	1321,4392	397,850891	229,699509	1919,3135	49,890167	-95,232025
2920	24-06-2021 14:33:15000	1244,0966	402,086243	1307,4592	398,662201	230,167923	1895,2437	49,941048	-95,153755
2921	24-06-2021 14:33:20000	1253,5181	398,344086	1315,2892	397,790558	229,664688	1910,7374	49,969887	-95,303612
2922	24-06-2021 14:33:25000	1260,7053	402,424835	1323,3757	398,004547	229,788239	1921,4987	49,96965	-95,264343
2923	24-06-2021 14:33:30000	1259,9609	406,293121	1323,8488	397,785156	229,66156	1923,2433	49,958988	-95,17408
2924	24-06-2021 14:33:35000	1262,946	398,615479	1324,3591	398,092102	229,838776	1922,4148	49,947948	-95,362808
2925	24-06-2021 14:33:40000	1265,8444	409,480194	1330,427	397,943939	229,753235	1932,0587	49,919544	-95,145721
2926	24-06-2021 14:33:45000	1263,1887	403,605652	1326,1008	398,27713	229,945618	1924,1914	49,907608	-95,255859
2927	24-06-2021 14:33:50000	1252,4135	397,738251	1314,0529	398,167786	229,882477	1907,1218	49,92305	-95,309204
2928	24-06-2021 14:33:55000	1253,0404	402,073273	1315,9686	398,069672	229,825821	1910,3586	49,941479	-95,218117
2929	24-06-2021 14:34:00000	1255,7666	406,76178	1320,0018	398,188385	229,894363	1915,7139	49,952469	-95,133698
2930	24-06-2021 14:34:05000	1257,9607	397,376923	1319,2322	398,131683	229,861633	1914,8522	49,954792	-95,355522
2931	24-06-2021 14:34:10000	1260,0122	399,799316	1321,9191	398,098877	229,842682	1918,9583	49,942467	-95,316887
2932	24-06-2021 14:34:15000	1258,8086	404,361816	1322,1603	398,402679	230,018097	1917,8068	49,940956	-95,208481
2933	24-06-2021 14:34:20000	1259,7128	405,144684	1323,2606	398,161743	229,878983	1920,465	49,936066	-95,197639
2934	24-06-2021 14:34:25000	1265,046	406,535645	1328,7636	398,24115	229,92482	1928,1101	49,90374	-95,20475
2935	24-06-2021 14:34:30000	1255,1503	401,153625	1317,6974	398,584198	230,122894	1910,4276	49,914303	-95,253304
2936	24-06-2021 14:34:35000	1257,3125	396,13678	1318,2408	398,410828	230,022797	1912,0875	49,923775	-95,378052

2937	24-06-2021 14:34:40000	1251,9921	406,799927	1316,4233	398,633118	230,151123	1908,3073	49,942421	-95,105583
2938	24-06-2021 14:34:45000	1257,3213	405,250488	1321,0166	398,335815	229,979492	1916,3619	49,953171	-95,178314
2939	24-06-2021 14:34:50000	1259,2183	407,550507	1323,5287	398,470184	230,057068	1919,4039	49,952354	-95,140991
2940	24-06-2021 14:34:55000	1259,9387	401,730682	1322,4344	398,336334	229,979782	1918,4185	49,950531	-95,274185
2941	24-06-2021 14:35:00000	1256,1345	404,927765	1319,788	398,371735	230,000229	1914,5028	49,960442	-95,176987
2942	24-06-2021 14:35:05000	1261,8722	404,924042	1325,249	398,21991	229,912567	1923,1644	49,945835	-95,217743
2943	24-06-2021 14:35:10000	1257,9327	405,825317	1321,775	398,498627	230,073486	1916,7025	49,940205	-95,169968
2944	24-06-2021 14:35:15000	1257,8857	398,524323	1319,5067	398,658722	230,165909	1912,665	49,934158	-95,329994
2945	24-06-2021 14:35:20000	1251,645	400,184662	1314,0636	398,718231	230,200287	1904,48	49,948772	-95,249962
2946	24-06-2021 14:35:25000	1257,6302	409,592224	1322,6487	398,490723	230,068939	1917,9283	49,951908	-95,084221
2947	24-06-2021 14:35:30000	1262,9955	402,573486	1325,603	398,391571	230,011703	1922,7189	49,936825	-95,277061
2948	24-06-2021 14:35:35000	1260,4865	401,441284	1322,8685	398,261078	229,936356	1919,3307	49,93679	-95,284332
2949	24-06-2021 14:35:40000	1255,0051	399,928345	1317,1866	398,618011	230,142426	1909,3966	49,947891	-95,279221
2950	24-06-2021 14:35:45000	1255,7601	406,581818	1319,9403	398,394806	230,01355	1914,5345	49,958965	-95,13765
2951	24-06-2021 14:35:50000	1258,3025	406,335114	1322,2833	398,427246	230,032288	1917,6887	49,955711	-95,161331
2952	24-06-2021 14:35:55000	1258,8779	401,436523	1321,3346	398,384735	230,007736	1916,5565	49,955318	-95,273216
2953	24-06-2021 14:36:00000	1258,1085	402,467957	1320,9153	398,32251	229,971817	1916,1948	49,95002	-95,245201
2954	24-06-2021 14:36:05000	1253,4409	401,760345	1316,2543	398,680176	230,178314	1907,7849	49,967194	-95,227867
2955	24-06-2021 14:36:10000	1255,5254	399,798126	1317,6429	398,422363	230,029449	1911,017	49,975327	-95,285721
2956	24-06-2021 14:36:15000	1263,6768	399,433319	1325,3022	398,109833	229,84903	1923,5573	49,96048	-95,350082
2957	24-06-2021 14:36:20000	1260,2614	405,988007	1324,0411	398,464935	230,054047	1920,192	49,946781	-95,182945
2958	24-06-2021 14:36:25000	1257,2085	399,96402	1319,297	398,53067	230,09198	1912,8978	49,952301	-95,293823
2959	24-06-2021 14:36:30000	1255,2893	409,590057	1320,4224	398,510925	230,080597	1914,5759	49,961319	-95,067253
2960	24-06-2021 14:36:35000	1253,2578	400,236908	1315,6157	398,393372	230,012741	1908,2346	49,980427	-95,26017
2961	24-06-2021 14:36:40000	1265,78	404,405487	1328,8125	397,904236	229,730331	1929,7053	49,959522	-95,256477
2962	24-06-2021 14:36:45000	1258,2002	407,116974	1322,4265	398,408447	230,021423	1917,989	49,947681	-95,143295
2963	24-06-2021 14:36:50000	1255,3512	409,094269	1320,3275	398,432709	230,035431	1914,8407	49,957874	-95,078773
2964	24-06-2021 14:36:55000	1258,4169	405,564392	1322,1556	398,187775	229,894043	1918,6104	49,955448	-95,179176
2965	24-06-2021 14:37:00000	1258,1093	402,735413	1320,9977	398,255249	229,932968	1916,7013	49,956642	-95,239326
2966	24-06-2021 14:37:05000	1257,3141	412,221466	1323,1649	398,100372	229,843536	1920,6357	49,957077	-95,023239



2967	24-06-2021 14:37:10000	1255,9343	396,500824	1317,036	398,273163	229,943314	1910,887	49,970406	-95,360664
2968	24-06-2021 14:37:15000	1255,0594	403,546112	1318,3413	398,321594	229,971283	1912,5548	49,979759	-95,19989
2969	24-06-2021 14:37:20000	1262,1859	402,345947	1324,7625	398,158844	229,877304	1922,6851	49,964088	-95,276398
2970	24-06-2021 14:37:25000	1262,4858	404,690369	1325,762	398,173584	229,885834	1924,0776	49,953133	-95,227188
2971	24-06-2021 14:37:30000	1257,9633	407,173462	1322,2185	398,517731	230,084518	1917,2345	49,963692	-95,140343
2972	24-06-2021 14:37:35000	1259,3657	409,098602	1324,1465	397,956818	229,760666	1922,6123	49,96936	-95,107742
2973	24-06-2021 14:37:40000	1267,9446	405,250916	1331,1317	397,595184	229,55188	1934,6475	49,927128	-95,25312
2974	24-06-2021 14:37:45000	1255,9045	400,627563	1318,256	398,470154	230,057053	1911,6659	49,921085	-95,270164
2975	24-06-2021 14:37:50000	1250,7252	410,556763	1316,3853	398,405701	230,019836	1909,3345	49,958	-95,012085
2976	24-06-2021 14:37:55000	1251,8793	403,293793	1315,2368	398,018433	229,796249	1909,4639	49,982975	-95,182808
2977	24-06-2021 14:38:00000	1254,9126	406,677826	1319,1636	397,861725	229,70578	1915,8926	49,992832	-95,129417
2978	24-06-2021 14:38:05000	1263,7823	408,28363	1328,0968	397,769135	229,652313	1929,2889	49,973495	-95,157394
2979	24-06-2021 14:38:10000	1259,6324	404,551849	1323,0027	398,287292	229,951477	1919,5311	49,962551	-95,210121
2980	24-06-2021 14:38:15000	1256,1294	403,622437	1319,3832	398,393646	230,012878	1913,6704	49,984184	-95,205803
2981	24-06-2021 14:38:20000	1263,5667	404,688446	1326,7905	397,863647	229,706879	1927,0043	49,972439	-95,234818
2982	24-06-2021 14:38:25000	1266,7483	406,468323	1330,3638	397,837555	229,691833	1932,2769	49,937408	-95,218193
2983	24-06-2021 14:38:30000	1261,3236	392,911438	1321,1042	398,470062	230,057022	1915,7699	49,927761	-95,474945
2984	24-06-2021 14:38:35000	1253,6953	404,767334	1317,4174	398,059845	229,82016	1912,3872	49,947803	-95,163109
2985	24-06-2021 14:38:40000	1252,6082	410,581055	1318,182	398,371918	230,000336	1912,105	49,984913	-95,025429
2986	24-06-2021 14:38:45000	1252,0741	397,639008	1313,6996	398,338501	229,981033	1905,744	50,011208	-95,309021
2987	24-06-2021 14:38:50000	1265,6296	405,653259	1329,0496	397,660339	229,589508	1931,2333	49,995411	-95,228172
2988	24-06-2021 14:38:55000	1259,9309	404,580505	1323,2957	398,296295	229,956696	1919,8533	49,989937	-95,211601
2989	24-06-2021 14:39:00000	1254,2314	410,294312	1319,6354	398,694061	230,18634	1912,6124	50,003803	-95,043777
2990	24-06-2021 14:39:05000	1258,8649	406,654694	1322,9167	398,638214	230,154068	1917,7081	50,014297	-95,158279
2991	24-06-2021 14:39:10000	1258,8695	405,371704	1322,5275	398,197418	229,899582	1919,2335	50,00362	-95,186653
2992	24-06-2021 14:39:15000	1266,4526	399,552704	1327,9852	398,004486	229,788208	1927,9874	49,973656	-95,366478
2993	24-06-2021 14:39:20000	1264,6403	410,022705	1329,4487	398,098358	229,842407	1929,8362	49,942135	-95,125168
2994	24-06-2021 14:39:25000	1257,6887	395,069427	1318,2795	398,437286	230,038086	1911,9445	49,930431	-95,403801
2995	24-06-2021 14:39:30000	1254,7125	406,279022	1318,8502	398,431549	230,03476	1912,7892	49,937866	-95,136841
2996	24-06-2021 14:39:35000	1254,2413	406,719818	1318,538	398,466675	230,055054	1912,1127	49,953213	-95,123642

2997	24-06-2021 14:39:40000	1255,5431	397,404358	1316,9353	398,392303	230,012115	1910,188	49,970898	-95,338249
2998	24-06-2021 14:39:45000	1254,3488	406,754456	1318,6508	398,332733	229,977722	1912,9126	49,980789	-95,12365
2999	24-06-2021 14:39:50000	1260,5256	404,90625	1323,9614	397,969391	229,767929	1922,4056	49,975212	-95,208633
3000	24-06-2021 14:39:55000	1267,3315	406,124359	1330,8141	397,814941	229,678772	1933,0316	49,933678	-95,22979
3001	24-06-2021 14:40:00000	1259,2721	409,462097	1324,1697	398,487457	230,067047	1920,1923	49,925655	-95,098999
3002	24-06-2021 14:40:05000	1251,8574	405,690308	1315,9526	398,548706	230,102402	1908,0498	49,960388	-95,129356
3003	24-06-2021 14:40:10000	1251,0995	406,610229	1315,5159	398,470093	230,057007	1907,8844	49,991112	-95,10334
3004	24-06-2021 14:40:15000	1260,578	409,424225	1325,3999	397,824951	229,68454	1925,1555	49,984863	-95,109253
3005	24-06-2021 14:40:20000	1258,4777	401,331635	1320,9214	398,063171	229,822067	1917,5951	49,974094	-95,27272
3006	24-06-2021 14:40:25000	1255,1389	403,032654	1318,2599	398,597412	230,130524	1911,1782	49,981449	-95,2118
3007	24-06-2021 14:40:30000	1238,865	410,551575	1305,1202	399,278961	230,524002	1888,8855	50,063236	-94,923431
3008	24-06-2021 14:40:35000	1254,2273	390,982056	1313,7552	399,111267	230,427216	1902,7177	50,085339	-95,468864
3009	24-06-2021 14:40:40000	1269,6199	389,620728	1328,0582	399,30011	230,53624	1922,8314	50,038338	-95,599709
3010	24-06-2021 14:40:45000	1268,3113	386,498169	1325,8937	399,512451	230,658829	1918,7201	49,997124	-95,657082
3011	24-06-2021 14:40:50000	1264,1665	390,826843	1323,2017	399,66156	230,744919	1914,2454	49,975124	-95,53846
3012	24-06-2021 14:40:55000	1265,665	394,682922	1325,7762	400,045685	230,96669	1916,1545	49,957951	-95,465965
3013	24-06-2021 14:41:00000	1252,7922	397,80957	1314,4355	400,282501	231,103424	1898,5754	49,983818	-95,31028
3014	24-06-2021 14:41:05000	1253,6526	396,128387	1314,7482	400,038879	230,962769	1900,1963	50,002861	-95,353065
3015	24-06-2021 14:41:10000	1250,6591	397,294128	1312,2463	400,276398	231,099899	1895,4045	50,032902	-95,306725
3016	24-06-2021 14:41:15000	1252,2662	403,614197	1315,7031	400,205078	231,058716	1900,7524	50,065964	-95,178467
3017	24-06-2021 14:41:20000	1265,011	386,588531	1322,7637	399,747406	230,794495	1913,1566	50,047485	-95,633942
3018	24-06-2021 14:41:25000	1264,6301	403,296967	1327,38	399,920227	230,894257	1919,0226	50,019344	-95,272652
3019	24-06-2021 14:41:30000	1258,3422	402,457123	1321,1346	399,970917	230,923553	1909,6389	50,013515	-95,247078
3020	24-06-2021 14:41:35000	1248,1877	396,194427	1309,5581	400,517365	231,239029	1890,4006	50,049709	-95,313652
3021	24-06-2021 14:41:40000	1260,9591	393,405304	1320,9033	399,894745	230,879547	1909,7506	50,057507	-95,461876
3022	24-06-2021 14:41:45000	1270,135	396,880859	1330,6981	399,404297	230,59639	1926,2802	50,024559	-95,448776
3023	24-06-2021 14:41:50000	1267,5702	392,083282	1326,8246	399,596161	230,707184	1919,6421	49,988663	-95,534119
3024	24-06-2021 14:41:55000	1271,0347	400,582275	1332,6648	399,33786	230,558029	1929,4153	49,943951	-95,375427
3025	24-06-2021 14:42:00000	1265,8616	390,785034	1324,8088	399,330933	230,554047	1918,1943	49,914787	-95,550507
3026	24-06-2021 14:42:05000	1259,4679	401,373016	1321,8772	399,437805	230,615753	1913,4937	49,903805	-95,278725

3027	24-06-2021 14:42:10000	1253,6588	402,26413	1316,6157	399,373779	230,578781	1906,0491	49,927357	-95,218285
3028	24-06-2021 14:42:15000	1256,8219	398,984344	1318,632	398,988678	230,35643	1910,8829	49,93454	-95,312576
3029	24-06-2021 14:42:20000	1261,3442	393,146942	1321,1941	399,187653	230,471313	1913,5881	49,92577	-95,470016
3030	24-06-2021 14:42:25000	1261,0326	390,48764	1320,1075	399,210907	230,484726	1911,8687	49,920059	-95,524994
3031	24-06-2021 14:42:30000	1250,5435	386,328278	1308,8578	399,831818	230,843216	1892,7603	49,95153	-95,544647
3032	24-06-2021 14:42:35000	1254,78	403,815186	1318,1578	399,255798	230,510635	1908,8646	49,976036	-95,191956
3033	24-06-2021 14:42:40000	1268,192	394,911682	1328,2568	399,033051	230,38205	1924,527	49,943054	-95,477921
3034	24-06-2021 14:42:45000	1267,1917	391,946198	1326,4224	399,2388	230,500839	1920,8884	49,905998	-95,534546
3035	24-06-2021 14:42:50000	1254,62	396,983948	1315,9283	399,960663	230,917603	1902,2306	49,92078	-95,341049
3036	24-06-2021 14:42:55000	1245,507	397,85495	1307,5076	399,751221	230,796692	1891,1101	49,971676	-95,258102
3037	24-06-2021 14:43:00000	1264,9235	398,630432	1326,2495	399,223602	230,492065	1920,652	49,9645	-95,375984
3038	24-06-2021 14:43:05000	1267,7388	400,896484	1329,6163	398,767151	230,228516	1927,8084	49,917992	-95,346207
3039	24-06-2021 14:43:10000	1261,059	386,26651	1318,8904	399,455109	230,625732	1908,9706	49,902016	-95,615158
3040	24-06-2021 14:43:15000	1251,4158	398,438843	1313,3145	399,743347	230,79213	1899,5623	49,928795	-95,286835
3041	24-06-2021 14:43:20000	1253,2659	401,652954	1316,0548	399,311768	230,542969	1905,5657	49,93792	-95,228996
3042	24-06-2021 14:43:25000	1260,9382	396,135681	1321,6991	399,366394	230,574509	1913,4148	49,932056	-95,402817
3043	24-06-2021 14:43:30000	1261,894	399,479675	1323,6165	399,22699	230,494003	1917,0083	49,927597	-95,33683
3044	24-06-2021 14:43:35000	1264,4397	390,839264	1323,4664	398,965424	230,343002	1917,9581	49,905273	-95,540001
3045	24-06-2021 14:43:40000	1258,291	393,199707	1318,2953	399,583374	230,699768	1907,5685	49,906273	-95,448349
3046	24-06-2021 14:43:45000	1255,6548	394,991852	1316,3159	399,320892	230,548233	1906,0004	49,911732	-95,391602
3047	24-06-2021 14:43:50000	1260,0319	398,615479	1321,5803	399,145508	230,446976	1914,4209	49,908421	-95,342812
3048	24-06-2021 14:43:55000	1257,0544	394,101654	1317,3845	399,259308	230,51268	1907,7489	49,913998	-95,420464
3049	24-06-2021 14:44:00000	1264,6201	393,156036	1324,3246	398,795319	230,244797	1919,932	49,89872	-95,491699
3050	24-06-2021 14:44:05000	1267,2217	395,208282	1327,4187	398,923218	230,318649	1923,8416	49,860851	-95,465111
3051	24-06-2021 14:44:10000	1247,5935	391,128784	1307,4675	399,798401	230,823929	1890,8232	49,896431	-95,420616
3052	24-06-2021 14:44:15000	1238,233	393,657227	1299,3025	400,019958	230,951828	1878,012	49,982067	-95,299828
3053	24-06-2021 14:44:20000	1268,823	392,400238	1328,1151	398,881561	230,294586	1924,9783	49,968552	-95,535622
3054	24-06-2021 14:44:25000	1271,0228	390,790466	1329,743	399,127808	230,436752	1926,1963	49,921894	-95,584106
3055	24-06-2021 14:44:30000	1259,8252	391,883728	1319,3682	399,543671	230,676849	1909,1934	49,917084	-95,487007
3056	24-06-2021 14:44:35000	1261,0281	389,170441	1319,7142	399,360382	230,571045	1910,5187	49,914234	-95,553123

3057	24-06-2021 14:44:40000	1259,7485	397,758789	1321,052	399,544128	230,677139	1911,6169	49,911228	-95,359497
3058	24-06-2021 14:44:45000	1257,3557	402,700409	1320,2692	399,427551	230,609802	1911,1229	49,915428	-95,234795
3059	24-06-2021 14:44:50000	1259,6464	393,210419	1319,5922	399,296478	230,534149	1910,6821	49,90369	-95,457253
3060	24-06-2021 14:44:55000	1259,9639	398,246643	1321,4043	399,394806	230,590912	1912,8662	49,894573	-95,350365
3061	24-06-2021 14:45:00000	1251,3914	393,884644	1311,9167	399,720703	230,779068	1897,5724	49,919167	-95,386497
3062	24-06-2021 14:45:05000	1256,1849	397,415558	1317,5507	399,577118	230,696167	1906,4601	49,931629	-95,342438
3063	24-06-2021 14:45:10000	1254,7983	395,670898	1315,703	399,380402	230,582611	1904,6401	49,935719	-95,370941
3064	24-06-2021 14:45:15000	1258,2323	401,493713	1320,7367	399,48407	230,642456	1911,4625	49,928322	-95,267448
3065	24-06-2021 14:45:20000	1256,535	386,736603	1314,7035	399,504547	230,654266	1902,661	49,931126	-95,575539
3066	24-06-2021 14:45:25000	1266,3914	398,754883	1327,6869	399,106873	230,424683	1923,2104	49,907997	-95,383286
3067	24-06-2021 14:45:30000	1260,9879	398,427826	1322,4353	399,422455	230,606888	1914,1858	49,892647	-95,353462
3068	24-06-2021 14:45:35000	1259,4106	394,681091	1319,8062	399,673584	230,751862	1909,1993	49,897774	-95,423912
3069	24-06-2021 14:45:40000	1252,6888	396,363098	1313,9	399,76413	230,804138	1900,2444	49,914005	-95,34127
3070	24-06-2021 14:45:45000	1257,7162	395,651825	1318,4805	399,463745	230,630722	1908,1858	49,921547	-95,39135
3071	24-06-2021 14:45:50000	1264,2025	402,286346	1326,6658	399,139496	230,443512	1921,6223	49,892666	-95,291702
3072	24-06-2021 14:45:55000	1267,1816	387,952881	1325,2384	399,25647	230,511063	1918,9558	49,856552	-95,619148
3073	24-06-2021 14:46:00000	1250,9293	392,203278	1310,9719	399,568207	230,691055	1896,8245	49,877071	-95,419991
3074	24-06-2021 14:46:05000	1245,0471	398,481781	1307,2605	399,850006	230,853729	1890,2039	49,935352	-95,240936
3075	24-06-2021 14:46:10000	1256,7091	399,842529	1318,7842	399,206268	230,482071	1909,8367	49,951054	-95,293007
3076	24-06-2021 14:46:15000	1265,5742	389,894501	1324,2717	399,027344	230,378769	1918,6599	49,922432	-95,567558
3077	24-06-2021 14:46:20000	1257,9807	396,640564	1319,0297	399,600372	230,709595	1908,2955	49,914925	-95,371681
3078	24-06-2021 14:46:25000	1261,0533	390,500244	1320,1311	399,278778	230,523941	1911,4625	49,911037	-95,524864
3079	24-06-2021 14:46:30000	1262,7954	387,710175	1320,9738	399,362213	230,572098	1912,3231	49,905014	-95,595802
3080	24-06-2021 14:46:35000	1254,5547	404,048767	1318,0148	399,393555	230,590195	1907,9335	49,914364	-95,185181
3081	24-06-2021 14:46:40000	1258,3883	393,816284	1318,5723	399,556854	230,684479	1907,9318	49,923759	-95,435684
3082	24-06-2021 14:46:45000	1258,5333	398,586853	1320,1431	399,517578	230,661804	1910,3022	49,937969	-95,333107
3083	24-06-2021 14:46:50000	1250,797	392,763	1311,0133	400,209839	231,061478	1893,8896	49,977371	-95,406891
3084	24-06-2021 14:46:55000	1260,4148	397,62265	1321,6464	399,673737	230,751968	1911,6671	49,981113	-95,36702
3085	24-06-2021 14:47:00000	1265,963	402,42218	1328,3848	399,726959	230,7827	1921,186	49,950382	-95,300934
3086	24-06-2021 14:47:05000	1255,7831	390,211975	1315,0121	400,006073	230,943832	1900,6012	49,944809	-95,495941

3087	24-06-2021 14:47:10000	1263,7307	395,516235	1324,1783	399,932648	230,901459	1914,1761	49,931297	-95,435081
3088	24-06-2021 14:47:15000	1256,9945	399,412079	1318,9258	400,051392	230,970001	1906,0212	49,928333	-95,304413
3089	24-06-2021 14:47:20000	1262,1096	385,58313	1319,6951	399,862305	230,86084	1908,0465	49,915958	-95,636459
3090	24-06-2021 14:47:25000	1252,1404	399,602112	1314,3582	400,036774	230,961563	1899,5105	49,931248	-95,266296
3091	24-06-2021 14:47:30000	1259,3999	395,510162	1320,0441	399,99115	230,935211	1907,9971	49,931419	-95,405899
3092	24-06-2021 14:47:35000	1257,8359	406,526154	1321,8981	400,093475	230,994293	1910,1141	49,93898	-95,15377
3093	24-06-2021 14:47:40000	1259,174	392,458588	1318,9171	400,182526	231,045715	1905,5048	49,938469	-95,470276
3094	24-06-2021 14:47:45000	1257,5007	391,302612	1316,9761	399,960083	230,917282	1903,6538	49,950138	-95,483948
3095	24-06-2021 14:47:50000	1260,4486	398,15802	1321,8398	399,862183	230,860764	1911,1012	49,950413	-95,355621
3096	24-06-2021 14:47:55000	1263,4858	398,137939	1324,7302	399,675842	230,753189	1916,1748	49,937973	-95,376839
3097	24-06-2021 14:48:00000	1264,0142	392,868042	1323,6605	400,035492	230,960831	1912,9526	49,912373	-95,493835
3098	24-06-2021 14:48:05000	1259,3185	393,394989	1319,3341	400,312073	231,120514	1905,4147	49,913128	-95,451065
3099	24-06-2021 14:48:10000	1249,9485	398,01001	1311,7863	400,689789	231,338593	1892,7621	49,939362	-95,285988
3100	24-06-2021 14:48:15000	1256,1006	395,473785	1316,8859	400,39743	231,169785	1901,4552	49,957733	-95,384171
3101	24-06-2021 14:48:20000	1264,9961	399,694305	1326,6389	399,616211	230,71875	1919,2804	49,935528	-95,353462
3102	24-06-2021 14:48:25000	1266,7482	392,104828	1326,0457	399,863129	230,861313	1917,1885	49,91048	-95,528244
3103	24-06-2021 14:48:30000	1269,1842	397,000854	1329,8263	399,603271	230,711304	1923,8359	49,882271	-95,439842
3104	24-06-2021 14:48:35000	1259,6678	401,402252	1322,0768	399,972931	230,924698	1910,9493	49,859573	-95,27948
3105	24-06-2021 14:48:40000	1257,7246	391,913452	1317,3713	400,066711	230,978851	1903,7245	49,870987	-95,47229
3106	24-06-2021 14:48:45000	1257,3707	400,420715	1319,5901	399,580109	230,697906	1909,2281	49,888744	-95,28495
3107	24-06-2021 14:48:50000	1269,3632	397,956055	1330,2826	399,156433	230,453308	1926,7137	49,851425	-95,420563
3108	24-06-2021 14:48:55000	1256,8412	394,44574	1317,2841	399,8013	230,825607	1904,8746	49,852329	-95,411552
3109	24-06-2021 14:49:00000	1255,5209	387,177307	1313,864	399,478271	230,639114	1901,4557	49,86729	-95,559418
3110	24-06-2021 14:49:05000	1253,2692	396,324463	1314,4417	399,46402	230,630875	1902,4093	49,883568	-95,34613
3111	24-06-2021 14:49:10000	1257,9672	393,303253	1318,017	399,321594	230,54866	1908,194	49,881214	-95,443924
3112	24-06-2021 14:49:15000	1256,7587	388,59787	1315,4659	399,855621	230,856979	1902,0721	49,892826	-95,537148
3113	24-06-2021 14:49:20000	1256,7389	397,335724	1318,0548	399,698181	230,766068	1906,547	49,90699	-95,348007
3114	24-06-2021 14:49:25000	1252,6173	392,551758	1312,6869	400,161926	231,033813	1896,6421	49,934235	-95,42392
3115	24-06-2021 14:49:30000	1260,4198	402,932465	1323,2583	399,702728	230,768707	1914,0536	49,936783	-95,251228
3116	24-06-2021 14:49:35000	1272,3527	396,685699	1332,7568	399,233795	230,497971	1930,0276	49,889397	-95,467728

3117	24-06-2021 14:49:40000	1262,8892	398,033356	1324,1296	399,91983	230,894043	1914,2842	49,864441	-95,375031
3118	24-06-2021 14:49:45000	1258,78	402,350311	1321,5192	400,003937	230,942596	1910,1644	49,861443	-95,252495
3119	24-06-2021 14:49:50000	1259,6925	395,494354	1320,3185	399,790985	230,819656	1909,4626	49,859463	-95,408226
3120	24-06-2021 14:49:55000	1260,046	399,42627	1321,8385	399,620239	230,721054	1912,4014	49,860851	-95,325256
3121	24-06-2021 14:50:00000	1253,3392	400,545898	1315,7874	399,84726	230,852127	1902,6432	49,871952	-95,253937
3122	24-06-2021 14:50:05000	1258,0269	389,583191	1316,9688	399,558411	230,685364	1905,7389	49,882542	-95,524429
3123	24-06-2021 14:50:10000	1257,6129	396,637299	1318,6779	399,578339	230,696869	1908,0964	49,890354	-95,369225
3124	24-06-2021 14:50:15000	1267,403	404,703003	1330,449	399,106445	230,424423	1927,3058	49,855137	-95,261292
3125	24-06-2021 14:50:20000	1256,5498	393,377869	1316,6866	399,6026	230,710876	1905,0476	49,852688	-95,432716
3126	24-06-2021 14:50:25000	1258,5735	392,350861	1318,312	399,559448	230,685959	1907,656	49,860271	-95,468567
3127	24-06-2021 14:50:30000	1257,4591	389,654358	1316,4475	399,55127	230,681244	1904,9368	49,868095	-95,519127
3128	24-06-2021 14:50:35000	1255,3298	399,178467	1317,2686	399,605835	230,712753	1905,8578	49,882023	-95,297943
3129	24-06-2021 14:50:40000	1259,5277	391,40683	1318,9426	399,430511	230,611526	1909,037	49,880909	-95,49527
3130	24-06-2021 14:50:45000	1252,5132	398,482849	1314,3737	399,818573	230,835587	1900,6803	49,908844	-95,293549
3131	24-06-2021 14:50:50000	1256,4209	398,028351	1317,9606	399,52594	230,666626	1907,176	49,925587	-95,330688
3132	24-06-2021 14:50:55000	1267,7629	397,006683	1328,4717	399,123962	230,434555	1924,3131	49,891663	-95,430176
3133	24-06-2021 14:51:00000	1262,9921	393,803497	1322,9626	399,607483	230,713699	1914,1488	49,878021	-95,466949
3134	24-06-2021 14:51:05000	1263,6022	399,043884	1325,1138	399,55838	230,685349	1917,4969	49,870407	-95,358017
3135	24-06-2021 14:51:10000	1259,684	389,572327	1318,5486	399,760284	230,80191	1907,0488	49,871223	-95,535652
3136	24-06-2021 14:51:15000	1247,5425	400,490356	1310,2499	400,295288	231,110794	1892,5807	49,910789	-95,214088
3137	24-06-2021 14:51:20000	1258,9334	400,535553	1321,1139	399,827362	230,840652	1910,4214	49,91848	-95,293327
3138	24-06-2021 14:51:25000	1261,6327	395,370972	1322,1329	399,163025	230,457092	1915,1469	49,902519	-95,424049
3139	24-06-2021 14:51:30000	1268,3915	392,339752	1327,6848	399,460419	230,628799	1921,7855	49,875435	-95,534065
3140	24-06-2021 14:51:35000	1262,7928	395,76178	1323,3567	399,463654	230,630646	1915,4884	49,84631	-95,423462
3141	24-06-2021 14:51:40000	1261,582	400,530884	1323,6366	399,74704	230,794281	1914,5149	49,8368	-95,311806
3142	24-06-2021 14:51:45000	1248,5887	390,275299	1308,1624	399,810852	230,831116	1891,8176	49,880779	-95,446007
3143	24-06-2021 14:51:50000	1250,6187	395,25528	1311,592	399,519257	230,66275	1898,1592	49,913948	-95,351189
3144	24-06-2021 14:51:55000	1266,7408	394,011841	1326,6038	398,956238	230,337692	1922,4681	49,894062	-95,487503
3145	24-06-2021 14:52:00000	1267,2761	396,70639	1327,9175	399,213013	230,485947	1923,1255	49,861118	-95,43335
3146	24-06-2021 14:52:05000	1261,2894	400,353973	1323,3044	399,325012	230,550613	1915,9598	49,848579	-95,313637

3147	24-06-2021 14:52:10000	1245,3469	393,130493	1305,9253	400,577484	231,273743	1884,9928	49,893703	-95,361275
3148	24-06-2021 14:52:15000	1243,1995	393,870697	1304,1008	399,960083	230,917267	1885,1857	49,955853	-95,330009
3149	24-06-2021 14:52:20000	1258,632	405,988098	1322,4904	399,615814	230,718521	1913,356	49,956688	-95,171356
3150	24-06-2021 14:52:25000	1262,6875	384,017517	1319,7913	399,440155	230,617111	1910,3285	49,928093	-95,673271
3151	24-06-2021 14:52:30000	1260,7836	382,343414	1317,4832	399,530365	230,669174	1906,5891	49,914215	-95,696373
3152	24-06-2021 14:52:35000	1255,1719	399,882355	1317,3314	399,791016	230,819672	1905,0729	49,926762	-95,281395
3153	24-06-2021 14:52:40000	1257,6688	394,726959	1318,158	399,511871	230,658508	1907,5942	49,929054	-95,411087
3154	24-06-2021 14:52:45000	1263,4004	401,699707	1325,7236	399,475922	230,637756	1918,7078	49,916458	-95,298927
3155	24-06-2021 14:52:50000	1262,7632	394,956879	1323,088	399,452118	230,624008	1915,0018	49,901638	-95,440605
3156	24-06-2021 14:52:55000	1268,4772	394,579407	1328,4303	398,764435	230,226974	1926,0413	49,863724	-95,486916
3157	24-06-2021 14:53:00000	1262,6077	396,505219	1323,4026	399,096588	230,418732	1917,2501	49,850471	-95,406166
3158	24-06-2021 14:53:05000	1249,0839	391,806763	1309,0925	399,500275	230,65181	1894,5865	49,88483	-95,416016
3159	24-06-2021 14:53:10000	1254,5692	399,167969	1316,5405	399,203979	230,480728	1906,7241	49,900959	-95,29287
3160	24-06-2021 14:53:15000	1260,2468	395,996399	1320,9978	398,986816	230,355377	1914,2694	49,886967	-95,401131
3161	24-06-2021 14:53:20000	1259,1727	397,464935	1320,4144	398,926544	230,320572	1913,6185	49,883003	-95,361931
3162	24-06-2021 14:53:25000	1261,8179	386,018921	1319,5436	399,262024	230,514252	1910,814	49,873585	-95,625336
3163	24-06-2021 14:53:30000	1248,5927	398,741058	1310,7166	399,615295	230,718201	1896,3398	49,902843	-95,260307
3164	24-06-2021 14:53:35000	1254,0133	401,972656	1316,8643	399,56369	230,688416	1905,5043	49,91832	-95,227226
3165	24-06-2021 14:53:40000	1259,9026	395,560181	1320,5387	399,330536	230,553802	1911,8525	49,917278	-95,408234
3166	24-06-2021 14:53:45000	1256,3086	394,550293	1316,8073	399,551849	230,68158	1905,3866	49,923256	-95,405663
3167	24-06-2021 14:53:50000	1256,5082	400,840057	1318,8955	399,799042	230,824295	1907,2614	49,935303	-95,269722
3168	24-06-2021 14:53:55000	1268,1152	395,138397	1328,251	399,189819	230,472565	1923,6823	49,905602	-95,472565
3169	24-06-2021 14:54:00000	1266,8831	391,182007	1325,9019	399,174347	230,463638	1920,4292	49,88467	-95,548775
3170	24-06-2021 14:54:05000	1264,3114	407,594421	1328,3887	399,348022	230,563919	1923,2061	49,858322	-95,176315
3171	24-06-2021 14:54:10000	1252,4784	389,665222	1311,694	399,561432	230,687119	1898,0511	49,874237	-95,485565
3172	24-06-2021 14:54:15000	1255,4414	385,489197	1313,2916	399,445587	230,620239	1900,9073	49,890591	-95,595016
3173	24-06-2021 14:54:20000	1255,2288	400,412079	1317,5466	399,612701	230,716736	1906,2118	49,903259	-95,270157
3174	24-06-2021 14:54:25000	1259,6827	396,52182	1320,6173	399,246857	230,505493	1912,3729	49,896698	-95,385902
3175	24-06-2021 14:54:30000	1260,0171	386,258301	1317,8916	399,284485	230,527237	1908,3329	49,886047	-95,608543
3176	24-06-2021 14:54:35000	1257,1721	391,264923	1316,6511	399,655853	230,741638	1904,7656	49,891209	-95,482559

3177	24-06-2021 14:54:40000	1257,8187	404,285065	1321,1942	399,425934	230,608887	1912,3414	49,894325	-95,203163
3178	24-06-2021 14:54:45000	1259,343	393,076141	1319,2626	399,446808	230,620941	1909,502	49,899921	-95,458107
3179	24-06-2021 14:54:50000	1259,5631	393,982056	1319,7428	399,365662	230,574097	1910,5383	49,898598	-95,440041
3180	24-06-2021 14:54:55000	1258,8674	402,32663	1321,5952	399,326599	230,551529	1913,368	49,890862	-95,253632
3181	24-06-2021 14:55:00000	1259,5736	390,68045	1318,771	399,323669	230,549835	1909,3878	49,887428	-95,511169
3182	24-06-2021 14:55:05000	1261,0295	400,336334	1323,0514	399,470947	230,634872	1914,8547	49,881748	-95,312218
3183	24-06-2021 14:55:10000	1247,0466	399,623169	1309,5128	399,913116	230,890167	1893,1671	49,921856	-95,229813
3184	24-06-2021 14:55:15000	1260,2095	387,982422	1318,582	399,284607	230,527283	1909,2974	49,922821	-95,57309
3185	24-06-2021 14:55:20000	1261,817	400,970551	1323,9938	399,483551	230,642151	1916,2457	49,905579	-95,303848
3186	24-06-2021 14:55:25000	1259,3629	403,298462	1322,3632	399,321686	230,548691	1914,558	49,892696	-95,235779
3187	24-06-2021 14:55:30000	1254,4064	392,759064	1314,4562	399,73938	230,789841	1901,1437	49,89238	-95,431587
3188	24-06-2021 14:55:35000	1252,6038	397,634094	1314,2028	399,552734	230,682083	1901,5964	49,909046	-95,31282
3189	24-06-2021 14:55:40000	1258,1008	392,120514	1317,7922	399,368286	230,575592	1907,7333	49,905552	-95,470352
3190	24-06-2021 14:55:45000	1264,2324	396,388794	1324,918	399,40567	230,597183	1917,8463	49,893665	-95,41967
3191	24-06-2021 14:55:50000	1258,4188	394,684784	1318,8608	399,701263	230,767838	1907,7377	49,899082	-95,417099
3192	24-06-2021 14:55:55000	1251,3074	401,494843	1314,1417	399,833435	230,844162	1900,2813	49,928955	-95,218605
3193	24-06-2021 14:56:00000	1263,7269	395,550079	1324,1848	399,245544	230,50473	1917,5076	49,914997	-95,434326
3194	24-06-2021 14:56:05000	1263,5591	398,279083	1324,8425	399,289246	230,529968	1918,2699	49,898865	-95,374283
3195	24-06-2021 14:56:10000	1267,0168	400,29776	1328,7474	399,487274	230,644302	1922,9967	49,877369	-95,354218
3196	24-06-2021 14:56:15000	1257,479	395,337982	1318,1599	399,557312	230,684738	1907,3995	49,874668	-95,396545
3197	24-06-2021 14:56:20000	1257,1667	401,939697	1319,8574	399,702728	230,768692	1909,1083	49,874496	-95,250191
3198	24-06-2021 14:56:25000	1255,6805	394,848053	1316,2974	399,683167	230,757401	1904,0887	49,895054	-95,394905
3199	24-06-2021 14:56:30000	1257,0721	392,851318	1317,028	399,610626	230,715515	1905,5037	49,914085	-95,447647
3200	24-06-2021 14:56:35000	1255,9402	391,193604	1315,4536	399,512238	230,658691	1903,7621	49,925297	-95,475822
3201	24-06-2021 14:56:40000	1261,8768	402,961182	1324,655	399,278259	230,523621	1918,1217	49,908192	-95,260788
3202	24-06-2021 14:56:45000	1269,5082	401,761475	1331,5643	398,95932	230,339493	1929,6267	49,875298	-95,339615
3203	24-06-2021 14:56:50000	1254,2423	389,238464	1313,2518	399,500427	230,651901	1900,5594	49,889133	-95,506615
3204	24-06-2021 14:56:55000	1257,7828	398,973969	1319,5446	399,347015	230,563324	1910,3491	49,895988	-95,319466
3205	24-06-2021 14:57:00000	1258,4656	401,51236	1320,9647	399,588776	230,702911	1911,2242	49,897522	-95,268677
3206	24-06-2021 14:57:05000	1260,9529	395,977905	1321,6659	399,307678	230,540619	1913,5895	49,894459	-95,406326



3207	24-06-2021 14:57:10000	1259,5732	386,842712	1317,6388	399,278412	230,523712	1907,9811	49,890167	-95,593208
3208	24-06-2021 14:57:15000	1264,6349	397,33609	1325,5857	399,203552	230,480499	1919,8495	49,872223	-95,40197
3209	24-06-2021 14:57:20000	1258,2251	403,777069	1321,4259	399,550079	230,680557	1912,1205	49,879971	-95,217232
3210	24-06-2021 14:57:25000	1252,0073	389,920349	1311,3199	399,589569	230,703354	1897,3546	49,887619	-95,476868
3211	24-06-2021 14:57:30000	1259,4791	402,499756	1322,2307	399,453552	230,624847	1913,6812	49,893002	-95,25412
3212	24-06-2021 14:57:35000	1258,4664	393,353333	1318,5084	399,593903	230,705872	1907,6543	49,897217	-95,446213
3213	24-06-2021 14:57:40000	1263,8186	402,75	1326,4407	399,386444	230,58609	1920,1433	49,87685	-95,278931
3214	24-06-2021 14:57:45000	1261,2534	398,036743	1322,5708	399,424744	230,6082	1914,4022	49,856159	-95,363777
3215	24-06-2021 14:57:50000	1254,0817	397,003113	1315,4209	399,904053	230,884933	1901,7529	49,872665	-95,336906
3216	24-06-2021 14:57:55000	1255,8358	399,283539	1317,7826	399,385864	230,585754	1907,5795	49,883045	-95,299164
3217	24-06-2021 14:58:00000	1254,2554	402,01944	1317,1091	399,489288	230,645462	1906,1885	49,892097	-95,227913
3218	24-06-2021 14:58:05000	1257,7062	391,642883	1317,2733	399,291931	230,531509	1907,3999	49,892342	-95,477997
3219	24-06-2021 14:58:10000	1262,8261	390,468384	1321,8152	399,231049	230,496368	1914,2678	49,882038	-95,53727
3220	24-06-2021 14:58:15000	1263,0353	395,419037	1323,4857	399,374878	230,579422	1915,9893	49,857571	-95,432487
3221	24-06-2021 14:58:20000	1253,5861	396,141846	1314,6887	399,849884	230,853653	1901,1292	49,870605	-95,35231
3222	24-06-2021 14:58:25000	1256,8729	402,54892	1319,7633	399,744049	230,792557	1908,9471	49,883469	-95,234718
3223	24-06-2021 14:58:30000	1258,8604	392,267578	1318,561	399,498077	230,650543	1908,3285	49,87812	-95,472282
3224	24-06-2021 14:58:35000	1255,5956	397,725067	1317,0822	399,85556	230,856934	1904,5812	49,889915	-95,331604
3225	24-06-2021 14:58:40000	1256,9095	396,342468	1317,9183	399,667511	230,748367	1906,4939	49,894161	-95,370811
3226	24-06-2021 14:58:45000	1262,9972	399,570862	1324,6957	399,340851	230,559769	1917,8851	49,870735	-95,342438
3227	24-06-2021 14:58:50000	1253,7554	395,878723	1314,771	399,963379	230,919189	1900,5692	49,888454	-95,35923
3228	24-06-2021 14:58:55000	1243,8232	392,483398	1304,2773	400,819885	231,413696	1881,422	49,955135	-95,364929
3229	24-06-2021 14:59:00000	1261,0319	397,041199	1322,0601	399,490936	230,646408	1913,2662	49,959541	-95,38385
3230	24-06-2021 14:59:05000	1268,8202	392,036987	1328,005	399,825043	230,83931	1920,3322	49,912079	-95,54332
3231	24-06-2021 14:59:10000	1258,5834	403,009674	1321,5328	400,330231	231,130997	1908,5791	49,914536	-95,236633
3232	24-06-2021 14:59:15000	1258,3517	393,235504	1318,3638	400,077576	230,985123	1905,1891	49,912704	-95,447983
3233	24-06-2021 14:59:20000	1259,7	393,617371	1319,7645	400,135864	231,018768	1906,933	49,903152	-95,448837
3234	24-06-2021 14:59:25000	1255,5154	398,778351	1317,3242	400,13974	231,021011	1903,3855	49,908379	-95,308006
3235	24-06-2021 14:59:30000	1260,1794	400,370728	1322,2515	400,016968	230,950119	1911,094	49,899212	-95,30558
3236	24-06-2021 14:59:35000	1264,6523	391,300446	1323,8057	399,67688	230,753784	1914,9309	49,869854	-95,531563

3237	24-06-2021 14:59:40000	1256,4548	397,305542	1317,7748	400,108063	231,002716	1904,2704	49,874001	-95,346703
3238	24-06-2021 14:59:45000	1245,7469	393,32251	1306,3645	400,562897	231,26532	1885,6852	49,930115	-95,359833
3239	24-06-2021 14:59:50000	1254,0309	401,27121	1316,667	400,144836	231,023941	1902,4476	49,956604	-95,242828
3240	24-06-2021 14:59:55000	1265,3224	398,317383	1326,5359	399,603821	230,711594	1919,2638	49,925449	-95,38546
3241	24-06-2021 15:00:00000	1266,2839	384,796509	1323,4589	399,794647	230,821777	1913,9929	49,898174	-95,679886
3242	24-06-2021 15:00:05000	1252,3295	394,827576	1313,0947	400,263885	231,092682	1896,6908	49,916374	-95,37236
3243	24-06-2021 15:00:10000	1253,9684	407,770905	1318,6029	399,523346	230,665115	1907,4156	49,943768	-95,098251
3244	24-06-2021 15:00:15000	1252,4646	401,576324	1315,2686	398,949493	230,333817	1905,0594	49,970985	-95,225014
3245	24-06-2021 15:00:20000	1263,8201	403,599487	1326,7003	398,50354	230,07634	1923,6666	49,961506	-95,260406
3246	24-06-2021 15:00:25000	1265,5979	413,927765	1331,5684	398,315216	229,967621	1931,6825	49,935795	-95,045662
3247	24-06-2021 15:00:30000	1263,8378	399,458832	1325,4634	398,512573	230,081558	1921,8843	49,908932	-95,350632
3248	24-06-2021 15:00:35000	1257,3585	409,799255	1322,4546	398,990082	230,357239	1915,2516	49,915546	-95,077644
3249	24-06-2021 15:00:40000	1258,7981	399,078888	1320,5441	398,913422	230,312988	1912,8762	49,923676	-95,324203
3250	24-06-2021 15:00:45000	1264,9845	407,227386	1328,9169	398,49231	230,069855	1926,9607	49,903446	-95,18914
3251	24-06-2021 15:00:50000	1259,9703	413,423065	1326,0632	398,94455	230,330963	1920,7465	49,901741	-95,015854
3252	24-06-2021 15:00:55000	1258,6748	403,638794	1321,8119	398,516388	230,083755	1916,5859	49,905537	-95,22345
3253	24-06-2021 15:01:00000	1260,9059	408,018372	1325,2783	398,354858	229,990509	1922,3904	49,890446	-95,142723
3254	24-06-2021 15:01:05000	1254,6188	406,107941	1318,7085	398,460388	230,051422	1912,3781	49,89267	-95,139969
3255	24-06-2021 15:01:10000	1257,5073	395,564453	1318,2549	398,630646	230,149719	1910,9128	49,896748	-95,391823
3256	24-06-2021 15:01:15000	1255,7139	413,240967	1321,9628	398,496124	230,072052	1916,8673	49,910343	-94,988602
3257	24-06-2021 15:01:20000	1257,8344	407,308136	1322,1372	398,452301	230,046753	1917,4033	49,908627	-95,136436
3258	24-06-2021 15:01:25000	1272,9255	401,147583	1334,6381	397,345093	229,407501	1941,0382	49,86475	-95,376083
3259	24-06-2021 15:01:30000	1265,5781	398,905396	1326,9565	398,117096	229,853226	1926,0293	49,826313	-95,374504
3260	24-06-2021 15:01:35000	1244,416	402,231018	1307,8077	400,217072	231,065643	1889,361	49,874741	-95,152824
3261	24-06-2021 15:01:40000	1254,9368	402,776276	1317,989	399,684814	230,758347	1906,5066	49,908955	-95,216026
3262	24-06-2021 15:01:45000	1256,9161	383,627075	1314,1567	399,110687	230,42688	1903,6102	49,908981	-95,64431
3263	24-06-2021 15:01:50000	1269,7625	401,027985	1331,5854	399,025665	230,377808	1929,2695	49,866009	-95,357178
3264	24-06-2021 15:01:55000	1265,8912	396,979187	1326,6774	399,29007	230,530457	1920,9637	49,836685	-95,418159
3265	24-06-2021 15:02:00000	1240,6483	391,493347	1300,9517	400,63504	231,306976	1877,3583	49,900005	-95,36467
3266	24-06-2021 15:02:05000	1245,4493	400,178406	1308,1617	399,847656	230,852371	1891,4823	49,968426	-95,206078

3267	24-06-2021 15:02:10000	1271,3698	390,216248	1329,906	398,919708	230,316635	1927,3217	49,919529	-95,598473
3268	24-06-2021 15:02:15000	1265,6755	396,280518	1326,2628	399,306549	230,539963	1920,3408	49,878437	-95,431732
3269	24-06-2021 15:02:20000	1257,0157	397,698395	1318,4281	399,512848	230,659073	1907,8767	49,873856	-95,342003
3270	24-06-2021 15:02:25000	1261,8174	394,250488	1321,9745	399,280212	230,52475	1914,2124	49,859844	-95,449448
3271	24-06-2021 15:02:30000	1240,4891	395,187958	1301,9165	400,610992	231,293091	1879,0065	49,923637	-95,281769
3272	24-06-2021 15:02:35000	1250,2034	400,988525	1312,9358	399,718353	230,77771	1899,0446	49,975281	-95,221977
3273	24-06-2021 15:02:40000	1270,2611	390,67392	1328,9806	399,210419	230,484467	1924,5861	49,944946	-95,581619
3274	24-06-2021 15:02:45000	1264,0728	401,242676	1326,2261	399,415863	230,603088	1919,5823	49,918976	-95,313522
3275	24-06-2021 15:02:50000	1258,4326	392,738678	1318,293	399,746521	230,794006	1906,6781	49,90818	-95,459251
3276	24-06-2021 15:02:55000	1253,3218	393,317108	1313,5881	399,836243	230,845795	1899,3933	49,928082	-95,412079
3277	24-06-2021 15:03:00000	1256,1807	387,638428	1314,6305	399,769043	230,806976	1901,1691	49,947819	-95,553894
3278	24-06-2021 15:03:05000	1262,6951	397,883759	1323,8997	399,429901	230,611191	1916,1086	49,930721	-95,376945
3279	24-06-2021 15:03:10000	1257,3077	397,541107	1318,6591	399,797882	230,823639	1906,8568	49,933628	-95,34745
3280	24-06-2021 15:03:15000	1259,1688	398,251526	1320,6478	400,011993	230,947266	1908,7606	49,942902	-95,344795
3281	24-06-2021 15:03:20000	1260,9851	394,836639	1321,3552	399,709991	230,772888	1911,1957	49,942585	-95,431206
3282	24-06-2021 15:03:25000	1263,9479	404,841095	1327,2004	399,735504	230,787613	1919,6036	49,923241	-95,234146
3283	24-06-2021 15:03:30000	1257,2568	384,846161	1314,839	399,733856	230,786667	1901,7098	49,935818	-95,620598
3284	24-06-2021 15:03:35000	1257,1313	394,606689	1317,6091	399,733948	230,786728	1905,7085	49,95195	-95,410042
3285	24-06-2021 15:03:40000	1266,1421	401,67395	1328,329	399,629303	230,726303	1921,7002	49,927708	-95,318413
3286	24-06-2021 15:03:45000	1262,5546	396,301147	1323,2909	399,756592	230,799805	1913,8264	49,910995	-95,41021
3287	24-06-2021 15:03:50000	1250,9711	400,067871	1313,386	400,173737	231,040634	1897,5518	49,929859	-95,24778
3288	24-06-2021 15:03:55000	1253,8365	393,283661	1314,0692	399,759552	230,801498	1900,5132	49,957439	-95,416321
3289	24-06-2021 15:04:00000	1264,3802	405,967102	1327,9557	399,538208	230,673706	1921,6136	49,935913	-95,212524
3290	24-06-2021 15:04:05000	1262,1056	393,321167	1321,9728	399,586182	230,701416	1912,7253	49,920223	-95,471375
3291	24-06-2021 15:04:10000	1257,9578	393,617615	1318,1018	399,946655	230,909531	1905,4738	49,919071	-95,437065
3292	24-06-2021 15:04:15000	1248,908	399,518707	1311,2537	399,856232	230,85733	1895,9011	49,954506	-95,245331
3293	24-06-2021 15:04:20000	1258,5693	404,501526	1321,9751	399,492523	230,647339	1913,1428	49,96413	-95,203705
3294	24-06-2021 15:04:25000	1260,8588	395,52298	1321,4399	399,458038	230,627441	1912,4521	49,952469	-95,415527
3295	24-06-2021 15:04:30000	1260,7584	391,448029	1320,13	399,703979	230,769424	1909,4485	49,947231	-95,502594
3296	24-06-2021 15:04:35000	1261,8463	394,046387	1321,9413	399,530457	230,669235	1912,8894	49,939743	-95,454041

3297	24-06-2021 15:04:40000	1264,6423	400,02356	1326,4008	399,360657	230,571213	1920,1636	49,91077	-95,343903
3298	24-06-2021 15:04:45000	1262,3328	395,184753	1322,7452	399,910767	230,888809	1912,3108	49,893414	-95,432793
3299	24-06-2021 15:04:50000	1250,4467	402,270203	1313,5593	399,839142	230,847458	1899,2607	49,923111	-95,19529
3300	24-06-2021 15:04:55000	1248,8617	395,270844	1309,9216	399,904327	230,885086	1893,7354	49,959465	-95,338661
3301	24-06-2021 15:05:00000	1257,8722	394,827515	1318,3821	399,237152	230,499893	1909,021	49,973534	-95,410294
3302	24-06-2021 15:05:05000	1271,2789	394,075531	1330,9567	399,082581	230,41066	1927,9126	49,919975	-95,516182
3303	24-06-2021 15:05:10000	1260,9511	393,6604	1320,9716	399,687317	230,759827	1910,6567	49,909721	-95,456329
3304	24-06-2021 15:05:15000	1257,9187	403,726837	1321,1188	399,753082	230,79776	1910,5475	49,900002	-95,216171
3305	24-06-2021 15:05:20000	1256,7787	396,580658	1317,8652	399,879303	230,870636	1905,3202	49,910496	-95,364731
3306	24-06-2021 15:05:25000	1253,1379	394,731171	1313,8369	399,779755	230,813156	1900,002	49,929718	-95,38002
3307	24-06-2021 15:05:30000	1253,3126	403,448029	1316,6483	399,759308	230,801361	1904,0809	49,952747	-95,189629
3308	24-06-2021 15:05:35000	1255,1392	393,604797	1315,4083	399,51889	230,662567	1903,3324	49,964329	-95,418213
3309	24-06-2021 15:05:40000	1256,7222	401,279144	1319,2328	399,40332	230,59584	1909,4214	49,976357	-95,261581
3310	24-06-2021 15:05:45000	1266,5249	392,681549	1326,0032	399,205231	230,481461	1920,1433	49,951359	-95,514481
3311	24-06-2021 15:05:50000	1267,2029	400,850128	1329,0914	399,431641	230,612183	1923,5258	49,920834	-95,343544
3312	24-06-2021 15:05:55000	1264,371	396,837738	1325,1846	399,274017	230,521194	1918,6678	49,896996	-95,410934
3313	24-06-2021 15:06:00000	1253,5681	394,32373	1314,1249	399,850464	230,854004	1899,9794	49,919456	-95,391853
3314	24-06-2021 15:06:05000	1257,432	395,136932	1318,0549	399,430176	230,611343	1907,6201	49,926174	-95,400589
3315	24-06-2021 15:06:10000	1250,8779	399,250916	1313,0486	399,761261	230,80249	1898,7849	49,955299	-95,26516
3316	24-06-2021 15:06:15000	1257,2047	396,0849	1318,1226	399,316193	230,545532	1908,2048	49,960842	-95,378441
3317	24-06-2021 15:06:20000	1261,4711	393,215149	1321,3356	399,470795	230,634796	1912,203	49,948154	-95,469398
3318	24-06-2021 15:06:25000	1259,1365	395,267761	1319,7201	399,599396	230,70903	1909,2397	49,944611	-95,409355
3319	24-06-2021 15:06:30000	1255,8506	400,057556	1318,0314	399,695007	230,764236	1906,4514	49,9547	-95,282295
3320	24-06-2021 15:06:35000	1258,2703	399,871674	1320,2808	399,377808	230,5811	1911,136	49,959652	-95,30323
3321	24-06-2021 15:06:40000	1262,3076	401,245087	1324,5446	398,77771	230,234634	1919,663	49,945072	-95,301262
3322	24-06-2021 15:06:45000	1259,665	397,400818	1320,8646	398,797699	230,24617	1914,1147	49,928726	-95,366699
3323	24-06-2021 15:06:50000	1257,9174	401,118256	1320,3226	398,830048	230,264862	1913,2111	49,92767	-95,273483
3324	24-06-2021 15:06:55000	1248,6201	401,232117	1311,5027	399,250488	230,507599	1898,3231	49,960762	-95,205299
3325	24-06-2021 15:07:00000	1255,9977	395,797516	1316,8849	398,714844	230,198349	1908,6652	49,970722	-95,376419
3326	24-06-2021 15:07:05000	1260,5223	393,922363	1320,6405	398,801422	230,248322	1913,7286	49,957001	-95,4478

3327	24-06-2021 15:07:10000	1262,7552	397,455963	1323,8286	398,825287	230,2621	1918,2162	49,936157	-95,386612
3328	24-06-2021 15:07:15000	1259,2701	399,408173	1321,0935	398,842224	230,271881	1914,0824	49,932373	-95,320282
3329	24-06-2021 15:07:20000	1260,9896	403,644562	1324,0179	398,230164	229,918518	1921,0702	49,928284	-95,239609
3330	24-06-2021 15:07:25000	1261,6907	405,994965	1325,4038	398,076141	229,82959	1923,8903	49,915932	-95,192924
3331	24-06-2021 15:07:30000	1252,7128	405,131561	1316,5944	398,449005	230,044861	1909,3171	49,936909	-95,147964
3332	24-06-2021 15:07:35000	1252,376	402,985107	1315,6149	398,301453	229,959656	1908,5907	49,967793	-95,193207
3333	24-06-2021 15:07:40000	1264,8849	403,812744	1327,7794	397,550995	229,526382	1929,8173	49,947388	-95,263168
3334	24-06-2021 15:07:45000	1265,4525	404,36615	1328,4886	397,261139	229,359039	1932,2587	49,91819	-95,255051
3335	24-06-2021 15:07:50000	1262,7101	398,755005	1324,176	397,734375	229,632263	1923,7825	49,901794	-95,35817
3336	24-06-2021 15:07:55000	1262,5873	407,676239	1326,7729	397,85614	229,702545	1926,9469	49,887897	-95,16227
3337	24-06-2021 15:08:00000	1254,0354	409,070068	1319,069	398,081421	229,832626	1914,7065	49,909103	-95,069733
3338	24-06-2021 15:08:05000	1251,4739	406,796661	1315,9294	397,987488	229,778366	1910,6913	49,938808	-95,101898
3339	24-06-2021 15:08:10000	1252,2267	406,669159	1316,6061	397,913177	229,735474	1911,9513	49,963211	-95,110207
3340	24-06-2021 15:08:15000	1257,9011	406,177704	1321,8531	397,696533	229,610397	1920,5305	49,97374	-95,161949
3341	24-06-2021 15:08:20000	1268,2052	407,871826	1332,1802	397,456085	229,471588	1936,726	49,931309	-95,197731
3342	24-06-2021 15:08:25000	1260,3264	398,749237	1321,9015	398,150696	229,87262	1918,4492	49,90892	-95,341927
3343	24-06-2021 15:08:30000	1246,9091	410,595734	1312,7723	398,531067	230,092224	1903,3817	49,948864	-94,982887
3344	24-06-2021 15:08:35000	1250,6525	406,740326	1315,1309	398,030884	229,803436	1909,2205	49,981567	-95,097183
3345	24-06-2021 15:08:40000	1268,8827	398,239258	1329,9089	397,250092	229,352661	1934,5114	49,955425	-95,411247
3346	24-06-2021 15:08:45000	1270,5761	408,779541	1334,715	397,241119	229,347473	1941,547	49,895725	-95,194557
3347	24-06-2021 15:08:50000	1260,7306	400,188477	1322,7216	397,825562	229,684906	1921,2292	49,883778	-95,31337
3348	24-06-2021 15:08:55000	1255,6404	401,742126	1318,3435	397,878601	229,715515	1914,5883	49,884686	-95,243797
3349	24-06-2021 15:09:00000	1258,9974	404,778229	1322,4673	397,761078	229,647675	1921,1884	49,882221	-95,200645
3350	24-06-2021 15:09:05000	1258,752	411,306244	1324,2467	397,506134	229,500488	1924,9783	49,872581	-95,054192
3351	24-06-2021 15:09:10000	1254,6547	408,086212	1319,3531	397,665497	229,592499	1917,1516	49,891338	-95,096199
3352	24-06-2021 15:09:15000	1255,7212	402,839081	1318,755	397,677216	229,599258	1916,1908	49,904789	-95,220192
3353	24-06-2021 15:09:20000	1259,7917	411,116821	1325,1763	397,306519	229,385223	1927,3064	49,907375	-95,065971
3354	24-06-2021 15:09:25000	1251,0813	402,568787	1314,2549	397,851318	229,699753	1908,9271	49,926147	-95,193199
3355	24-06-2021 15:09:30000	1258,3719	408,595398	1323,0458	397,856232	229,702606	1921,7106	49,93578	-95,111748
3356	24-06-2021 15:09:35000	1263,7089	403,064545	1326,4318	398,029816	229,802826	1925,707	49,911995	-95,271309

3357	24-06-2021 15:09:40000	1259,3604	407,930969	1323,7811	397,988892	229,77919	1922,0253	49,895866	-95,133583
3358	24-06-2021 15:09:45000	1254,3392	398,43042	1316,098	398,232758	229,919983	1909,7351	49,913563	-95,307442
3359	24-06-2021 15:09:50000	1256,3423	413,548279	1322,6556	397,969513	229,768005	1920,4784	49,923122	-94,986343
3360	24-06-2021 15:09:55000	1255,1144	404,026917	1318,5409	397,942291	229,752289	1914,6793	49,930187	-95,189651
3361	24-06-2021 15:10:00000	1260,8046	406,518646	1324,7209	397,772034	229,653992	1924,4441	49,922638	-95,17511
3362	24-06-2021 15:10:05000	1254,0768	404,173035	1317,598	398,216064	229,910355	1911,918	49,930267	-95,179016
3363	24-06-2021 15:10:10000	1256,5173	404,539734	1320,0333	397,996368	229,783493	1916,6141	49,946785	-95,188293
3364	24-06-2021 15:10:15000	1261,0753	402,398315	1323,7203	397,881012	229,716904	1922,5249	49,946484	-95,267509
3365	24-06-2021 15:10:20000	1263,9219	415,487122	1330,4617	397,860779	229,705231	1932,3615	49,915283	-94,998749
3366	24-06-2021 15:10:25000	1265,069	406,566193	1328,7948	397,931976	229,746353	1929,5898	49,884384	-95,204239
3367	24-06-2021 15:10:30000	1250,2466	401,852234	1313,2408	398,432556	230,035339	1904,6049	49,906235	-95,20314
3368	24-06-2021 15:10:35000	1248,2913	405,021454	1312,3542	398,096069	229,841064	1905,0002	49,950996	-95,118477
3369	24-06-2021 15:10:40000	1263,7366	404,398132	1326,8639	397,675964	229,598526	1928,0161	49,934875	-95,242363
3370	24-06-2021 15:10:45000	1264,7573	408,950134	1329,2297	397,513458	229,5047	1932,25	49,91497	-95,149651
3371	24-06-2021 15:10:50000	1258,4792	407,99884	1322,9637	397,883087	229,718124	1921,3918	49,903275	-95,125755
3372	24-06-2021 15:10:55000	1259,787	404,774353	1323,2179	397,587402	229,547409	1923,0994	49,894459	-95,206314
3373	24-06-2021 15:11:00000	1260,6759	409,644745	1325,5613	397,702179	229,613663	1925,9142	49,888363	-95,105064
3374	24-06-2021 15:11:05000	1252,9124	399,48999	1315,0594	398,070648	229,826401	1908,9844	49,905521	-95,274193
3375	24-06-2021 15:11:10000	1249,9845	407,914185	1314,8595	398,015747	229,794693	1908,958	49,937714	-95,066017
3376	24-06-2021 15:11:15000	1254,6747	406,5737	1318,905	397,844788	229,695999	1915,5763	49,954231	-95,13002
3377	24-06-2021 15:11:20000	1260,1675	403,706909	1323,2542	397,685455	229,604004	1922,7467	49,948509	-95,232468
3378	24-06-2021 15:11:25000	1270,0736	405,728577	1333,3052	397,447021	229,466354	1938,421	49,907753	-95,25753
3379	24-06-2021 15:11:30000	1250,6367	408,15921	1315,5554	398,354889	229,990509	1908,3402	49,923035	-95,0653
3380	24-06-2021 15:11:35000	1256,6125	402,318817	1319,4452	397,709259	229,617752	1917,0343	49,940353	-95,237953
3381	24-06-2021 15:11:40000	1265,9095	400,651764	1327,7985	397,466034	229,477325	1930,3884	49,908283	-95,338982
3382	24-06-2021 15:11:45000	1258,5946	400,910248	1320,9048	397,751465	229,64212	1919,0361	49,900093	-95,282768
3383	24-06-2021 15:11:50000	1250,1058	404,606506	1313,9524	398,284485	229,949844	1906,313	49,925579	-95,140877
3384	24-06-2021 15:11:55000	1258,2582	405,19989	1321,8928	397,694122	229,609009	1920,687	49,927185	-95,186096
3385	24-06-2021 15:12:00000	1255,6178	406,029694	1319,6349	397,74646	229,639236	1917,1953	49,926647	-95,14888
3386	24-06-2021 15:12:05000	1259,3047	408,011963	1323,7531	397,665924	229,592728	1923,5144	49,925362	-95,131393

3387	24-06-2021 15:12:10000	1260,7263	395,867218	1321,4166	397,699463	229,612091	1920,0214	49,922993	-95,407181
3388	24-06-2021 15:12:15000	1264,5377	410,309052	1329,4393	397,463837	229,476074	1932,6904	49,90509	-95,118118
3389	24-06-2021 15:12:20000	1262,952	410,022034	1327,8427	397,607056	229,558746	1929,7915	49,887024	-95,113083
3390	24-06-2021 15:12:25000	1248,4678	404,821381	1312,4602	398,076019	229,829498	1905,176	49,925415	-95,124229
3391	24-06-2021 15:12:30000	1250,994	398,410522	1312,9041	398,138245	229,865417	1905,5076	49,960197	-95,2845
3392	24-06-2021 15:12:35000	1259,8499	412,066925	1325,5266	397,482056	229,486572	1926,9456	49,951237	-95,045235
3393	24-06-2021 15:12:40000	1255,7271	392,108185	1315,5225	397,670746	229,59552	1911,6311	49,9571	-95,454628
3394	24-06-2021 15:12:45000	1260,3398	411,600128	1325,8473	397,666382	229,593002	1926,6648	49,94976	-95,059196
3395	24-06-2021 15:12:50000	1266,8123	402,573853	1329,2401	397,562714	229,533142	1932,0005	49,919029	-95,303497
3396	24-06-2021 15:12:55000	1264,4392	403,914612	1327,386	397,195496	229,321121	1931,1178	49,891312	-95,257843
3397	24-06-2021 15:13:00000	1257,3351	401,595581	1319,9131	397,756897	229,645248	1917,5714	49,88308	-95,258934
3398	24-06-2021 15:13:05000	1244,4332	395,212585	1305,6825	398,493103	230,070313	1893,2771	49,935093	-95,309013
3399	24-06-2021 15:13:10000	1248,4591	407,422516	1313,2568	397,909119	229,733139	1907,1462	49,983501	-95,06588
3400	24-06-2021 15:13:15000	1264,2632	412,42868	1329,8341	397,163208	229,30249	1934,7292	49,962463	-95,069237
3401	24-06-2021 15:13:20000	1270,5841	399,022308	1331,7667	397,200562	229,324066	1937,4362	49,898846	-95,405899
3402	24-06-2021 15:13:25000	1261,8854	400,439453	1323,8983	397,751465	229,642136	1923,3467	49,882576	-95,315887
3403	24-06-2021 15:13:30000	1247,6029	408,985626	1312,929	398,22583	229,916	1905,1248	49,918449	-95,024406
3404	24-06-2021 15:13:35000	1250,1296	399,277222	1312,3439	398,315277	229,967651	1903,8521	49,947979	-95,259308
3405	24-06-2021 15:13:40000	1253,8575	403,472595	1317,1746	397,77478	229,655579	1913,4814	49,969452	-95,192963
3406	24-06-2021 15:13:45000	1265,9984	404,827209	1329,149	397,756561	229,645081	1930,9714	49,939243	-95,248795
3407	24-06-2021 15:13:50000	1259,2526	406,246429	1323,1604	397,971558	229,769196	1921,1715	49,930725	-95,170067
3408	24-06-2021 15:13:55000	1265,6871	406,283905	1329,2969	397,824738	229,684433	1930,7676	49,907753	-95,214775
3409	24-06-2021 15:14:00000	1255,1929	409,176147	1320,2023	398,111389	229,84993	1916,2209	49,910213	-95,07579
3410	24-06-2021 15:14:05000	1250,9829	409,050232	1316,1613	397,967255	229,766708	1911,0756	49,936092	-95,047852
3411	24-06-2021 15:14:10000	1258,7172	402,802399	1321,5969	397,79425	229,666684	1919,7252	49,943539	-95,242126
3412	24-06-2021 15:14:15000	1262,4502	407,491241	1326,5857	397,638519	229,57692	1927,7488	49,935398	-95,165375
3413	24-06-2021 15:14:20000	1255,1138	416,252808	1322,3376	397,911987	229,734802	1920,2744	49,947762	-94,916283
3414	24-06-2021 15:14:25000	1259,9601	402,372681	1322,65	397,751526	229,642151	1921,5077	49,940666	-95,260277
3415	24-06-2021 15:14:30000	1263,9379	404,395874	1327,0551	397,530548	229,514587	1929,0315	49,920883	-95,24382
3416	24-06-2021 15:14:35000	1263,1898	402,370514	1325,7264	397,404022	229,441544	1927,6648	49,903736	-95,282845

3417	24-06-2021 15:14:40000	1256,0187	408,334076	1320,7269	397,647888	229,582321	1919,1857	49,906616	-95,100555
3418	24-06-2021 15:14:45000	1258,4315	400,033875	1320,4836	397,547363	229,524292	1919,3807	49,923607	-95,300804
3419	24-06-2021 15:14:50000	1259,9884	405,413086	1323,6051	397,379059	229,427109	1924,7186	49,920151	-95,19368
3420	24-06-2021 15:14:55000	1261,6925	406,074982	1325,4302	397,307922	229,386047	1927,772	49,901676	-95,191177
3421	24-06-2021 15:15:00000	1258,8141	400,485138	1320,985	397,629517	229,571716	1919,6782	49,891235	-95,293594
3422	24-06-2021 15:15:05000	1249,7791	404,275421	1313,5396	398,130096	229,860733	1906,4659	49,921139	-95,145897
3423	24-06-2021 15:15:10000	1247,2311	397,278168	1308,9749	398,207642	229,905502	1899,4611	49,971855	-95,283043
3424	24-06-2021 15:15:15000	1261,1812	402,191437	1323,7582	397,395599	229,436676	1924,8683	49,961292	-95,272774
3425	24-06-2021 15:15:20000	1270,1415	411,338959	1335,0876	397,28421	229,37236	1941,7911	49,916985	-95,135437
3426	24-06-2021 15:15:25000	1255,6207	401,318451	1318,1957	397,903381	229,729828	1914,363	49,92057	-95,252983
3427	24-06-2021 15:15:30000	1257,1071	411,983582	1322,894	397,682129	229,602081	1922,2689	49,932198	-95,027039
3428	24-06-2021 15:15:35000	1257,803	401,294403	1320,2672	397,496063	229,494659	1919,3073	49,927464	-95,268822
3429	24-06-2021 15:15:40000	1259,6033	403,981201	1322,8005	397,671234	229,59581	1922,0864	49,921745	-95,222466
3430	24-06-2021 15:15:45000	1260,1796	409,013214	1324,894	397,93631	229,748825	1923,8822	49,917225	-95,115494
3431	24-06-2021 15:15:50000	1254,7074	405,871338	1318,7198	397,999481	229,785324	1914,6418	49,927586	-95,145859
3432	24-06-2021 15:15:55000	1254,3632	410,620758	1319,8623	397,770874	229,653336	1917,3776	49,935322	-95,03743
3433	24-06-2021 15:16:00000	1258,7072	401,758972	1321,2698	397,884399	229,718872	1918,9359	49,932503	-95,264961
3434	24-06-2021 15:16:05000	1261,3999	408,931488	1326,0297	397,81604	229,679413	1926,254	49,910397	-95,126068
3435	24-06-2021 15:16:10000	1254,0659	408,273041	1318,851	398,084564	229,834442	1914,3551	49,922852	-95,087753
3436	24-06-2021 15:16:15000	1249,5223	407,088043	1314,1639	398,196838	229,899246	1907,2042	49,962509	-95,081161
3437	24-06-2021 15:16:20000	1260,4406	403,670898	1323,5032	397,824829	229,684479	1922,486	49,957172	-95,235176
3438	24-06-2021 15:16:25000	1261,2534	404,76001	1324,6096	397,952759	229,758347	1923,4613	49,936951	-95,216988
3439	24-06-2021 15:16:30000	1256,0543	399,950409	1318,1929	398,175751	229,887085	1912,9639	49,930218	-95,286072
3440	24-06-2021 15:16:35000	1258,1141	399,866669	1320,1305	398,088593	229,836777	1916,2263	49,927238	-95,302254
3441	24-06-2021 15:16:40000	1259,3003	403,644684	1322,4093	398,054413	229,817032	1919,7592	49,920273	-95,22773
3442	24-06-2021 15:16:45000	1253,8165	407,245605	1318,2961	398,348755	229,986969	1912,3076	49,929359	-95,108864
3443	24-06-2021 15:16:50000	1248,6255	407,856018	1313,5494	398,48996	230,068497	1904,774	49,971275	-95,057365
3444	24-06-2021 15:16:55000	1242,8281	395,758026	1304,3184	398,941803	230,329361	1889,304	50,044655	-95,285652
3445	24-06-2021 15:17:00000	1256,5309	409,492249	1321,5725	398,442566	230,041122	1916,6049	50,062389	-95,078468
3446	24-06-2021 15:17:05000	1265,6998	404,140656	1328,6558	398,125275	229,857941	1928,5023	50,033943	-95,261696



3447	24-06-2021 15:17:10000	1262,931	402,572296	1325,5411	398,698547	230,188934	1921,1406	50,006924	-95,276642
3448	24-06-2021 15:17:15000	1260,8845	404,705109	1324,2417	398,576141	230,118256	1919,8615	49,995197	-95,215591
3449	24-06-2021 15:17:20000	1265,6951	405,370209	1329,0256	398,281769	229,948288	1928,1366	49,960152	-95,234818
3450	24-06-2021 15:17:25000	1261,0591	404,085144	1324,2185	398,626862	230,147552	1919,6691	49,937237	-95,230431
3451	24-06-2021 15:17:30000	1249,7511	404,957367	1313,7231	399,066193	230,401184	1902,2455	49,956181	-95,130486
3452	24-06-2021 15:17:35000	1246,3436	404,243744	1310,2616	399,025757	230,377838	1897,4537	49,999729	-95,121742
3453	24-06-2021 15:17:40000	1253,7136	402,923981	1316,8695	398,783844	230,238174	1908,2354	50,01569	-95,204079
3454	24-06-2021 15:17:45000	1256,4448	409,627747	1321,5327	398,898102	230,304138	1914,4098	50,017117	-95,074821
3455	24-06-2021 15:17:50000	1249,2317	400,272766	1311,792	399,023865	230,376755	1899,6272	50,046211	-95,230934
3456	24-06-2021 15:17:55000	1259,2269	404,569489	1322,6219	398,528351	230,090652	1917,7592	50,048065	-95,206863
3457	24-06-2021 15:18:00000	1270,3494	416,591217	1336,9127	397,920776	229,739868	1941,4515	50,002831	-95,021111
3458	24-06-2021 15:18:05000	1276,8147	398,161346	1337,4559	397,899994	229,72789	1942,3507	49,91589	-95,465927
3459	24-06-2021 15:18:10000	1256,4872	398,297333	1318,105	398,806885	230,25148	1909,8484	49,920876	-95,325272
3460	24-06-2021 15:18:15000	1248,0793	411,790131	1314,2577	398,802887	230,249161	1904,2773	49,971153	-94,964584
3461	24-06-2021 15:18:20000	1254,6981	407,245178	1319,1345	398,157562	229,876587	1914,4698	49,994068	-95,11525
3462	24-06-2021 15:18:25000	1258,697	399,296997	1320,5136	398,200775	229,901535	1916,2524	50,000153	-95,318741
3463	24-06-2021 15:18:30000	1255,9965	408,964355	1320,9009	398,545502	230,100571	1915,1431	49,997692	-95,086357
3464	24-06-2021 15:18:35000	1258,2292	400,783203	1320,5182	398,484406	230,065292	1914,9003	49,993465	-95,282997
3465	24-06-2021 15:18:40000	1263,1255	409,518036	1327,8521	398,14679	229,870377	1927,0841	49,971195	-95,125473
3466	24-06-2021 15:18:45000	1258,3525	405,258698	1322,0007	398,492859	230,070175	1917,074	49,956879	-95,185471
3467	24-06-2021 15:18:50000	1266,6215	402,585266	1329,0616	398,15744	229,876541	1928,8138	49,929752	-95,301933
3468	24-06-2021 15:18:55000	1254,4681	410,613861	1319,9597	398,650604	230,16124	1913,2903	49,94239	-95,038353
3469	24-06-2021 15:19:00000	1247,3947	403,329163	1310,9797	398,774261	230,232651	1899,7397	49,981724	-95,149803
3470	24-06-2021 15:19:05000	1259,0653	399,791748	1321,0144	398,394073	230,013138	1916,1215	49,98893	-95,310493
3471	24-06-2021 15:19:10000	1262,3367	413,956818	1328,4781	398,161713	229,878998	1927,9801	49,973667	-95,021263
3472	24-06-2021 15:19:15000	1259,3372	399,943451	1321,3195	398,426178	230,031677	1916,3287	49,963982	-95,309067
3473	24-06-2021 15:19:20000	1254,1831	406,000763	1318,261	398,807739	230,251968	1910,0382	49,975914	-95,139214
3474	24-06-2021 15:19:25000	1252,5548	406,00769	1316,714	398,354187	229,990112	1909,9913	49,985676	-95,127327
3475	24-06-2021 15:19:30000	1254,6399	403,607788	1317,9607	398,414978	230,025223	1911,4473	50,001347	-95,195541
3476	24-06-2021 15:19:35000	1253,3889	412,779358	1319,61	398,1539	229,874481	1915,2778	50,008015	-94,981766



3477	24-06-2021 15:19:40000	1256,1699	395,98349	1317,1051	398,502258	230,075592	1909,8339	50,01918	-95,37355
3478	24-06-2021 15:19:45000	1258,1215	406,164337	1322,0586	398,021362	229,797958	1919,3433	50,022694	-95,163818
3479	24-06-2021 15:19:50000	1261,2896	413,973999	1327,4885	398,372406	230,000641	1925,5457	50,02206	-95,013214
3480	24-06-2021 15:19:55000	1266,4576	402,287079	1328,8153	397,906647	229,731735	1929,7448	50,000568	-95,307281
3481	24-06-2021 15:20:00000	1266,2258	404,797852	1329,3566	398,082611	229,833298	1929,6876	49,976086	-95,251022
3482	24-06-2021 15:20:05000	1263,3905	405,67627	1326,9247	397,877716	229,715012	1927,1304	49,950981	-95,211929
3483	24-06-2021 15:20:10000	1258,9636	403,318085	1321,989	398,387482	230,009338	1917,5222	49,942532	-95,232536
3484	24-06-2021 15:20:15000	1256,4625	408,51001	1321,2034	398,482697	230,064316	1915,7902	49,964462	-95,099854
3485	24-06-2021 15:20:20000	1253,7865	404,072479	1317,2909	398,208832	229,906189	1911,5356	49,979885	-95,179169
3486	24-06-2021 15:20:25000	1256,9117	400,150909	1319,0709	398,101105	229,843994	1914,5839	49,998238	-95,287659
3487	24-06-2021 15:20:30000	1257,5593	408,350525	1322,1971	398,009033	229,790833	1919,6095	50,009022	-95,11132
3488	24-06-2021 15:20:35000	1255,2094	400,58606	1317,5811	398,545349	230,100479	1910,3623	50,017139	-95,266197
3489	24-06-2021 15:20:40000	1254,0414	408,266449	1318,8258	398,493561	230,070572	1912,4852	50,03706	-95,087723
3490	24-06-2021 15:20:45000	1257,1141	407,078583	1321,3816	398,535065	230,094543	1915,9104	50,052254	-95,136353
3491	24-06-2021 15:20:50000	1261,1093	395,173889	1321,5745	398,84317	230,27243	1914,6343	50,044888	-95,424767
3492	24-06-2021 15:20:55000	1260,147	410,719818	1325,391	398,704102	230,192123	1920,829	50,038685	-95,077377
3493	24-06-2021 15:21:00000	1258,0961	403,961548	1321,3594	398,803192	230,249329	1914,6125	50,020512	-95,212257
3494	24-06-2021 15:21:05000	1260,0898	392,62262	1319,8406	398,450043	230,045456	1914,1854	50,011826	-95,472885
3495	24-06-2021 15:21:10000	1255,4392	407,997375	1320,0718	398,74765	230,21727	1912,9609	50,018112	-95,103859
3496	24-06-2021 15:21:15000	1254,8904	411,044067	1320,4951	398,630371	230,149567	1914,2036	50,022751	-95,031815
3497	24-06-2021 15:21:20000	1261,7164	408,418304	1326,1727	398,365967	229,996902	1923,6407	50,01086	-95,139679
3498	24-06-2021 15:21:25000	1259,5156	403,427032	1322,548	398,342987	229,983643	1918,405	49,98621	-95,234024
3499	24-06-2021 15:21:30000	1262,7209	401,11026	1324,8976	398,214935	229,909714	1922,4861	49,962402	-95,30706
3500	24-06-2021 15:21:35000	1259,0919	406,53302	1323,0953	398,289032	229,952499	1919,4727	49,951584	-95,16259
3501	24-06-2021 15:21:40000	1257,8146	399,004211	1319,5841	398,322388	229,971756	1914,2905	49,947788	-95,319023
3502	24-06-2021 15:21:45000	1251,6176	410,78299	1317,3037	398,607605	230,136414	1909,7318	49,967133	-95,013588
3503	24-06-2021 15:21:50000	1249,5143	414,186951	1316,3726	398,638489	230,154251	1908,1393	50,010807	-94,921021
3504	24-06-2021 15:21:55000	1258,5814	407,639374	1322,9501	398,239563	229,92392	1919,5613	50,004009	-95,134453
3505	24-06-2021 15:22:00000	1262,4113	401,416138	1324,6951	398,41507	230,025253	1921,3563	49,98214	-95,298248
3506	24-06-2021 15:22:05000	1253,4725	404,080811	1316,9946	398,563995	230,111237	1909,575	49,985275	-95,176743

3507	24-06-2021 15:22:10000	1251,095	395,912567	1312,2445	398,917053	230,315079	1900,9298	50,01548	-95,340088
3508	24-06-2021 15:22:15000	1257,4019	410,028687	1322,5669	398,558929	230,108307	1917,5521	50,03075	-95,072845
3509	24-06-2021 15:22:20000	1253,8065	416,46701	1321,1644	398,842651	230,27211	1914,2585	50,038754	-94,901619
3510	24-06-2021 15:22:25000	1260,4191	396,275085	1321,2457	398,632416	230,150742	1915,2739	50,037575	-95,396271
3511	24-06-2021 15:22:30000	1261,3403	404,493103	1324,6108	398,798004	230,246338	1919,4089	50,033051	-95,223457
3512	24-06-2021 15:22:35000	1256,1199	408,432983	1320,8538	398,88913	230,29895	1913,505	50,037426	-95,099091
3513	24-06-2021 15:22:40000	1264,2134	397,748657	1325,3073	398,528564	230,090775	1921,7386	50,032825	-95,390205
3514	24-06-2021 15:22:45000	1263,0013	398,874084	1324,4896	398,519318	230,085449	1920,5122	50,014229	-95,357582
3515	24-06-2021 15:22:50000	1255,2981	409,671814	1320,4561	398,724091	230,203659	1913,7576	50,02177	-95,065491
3516	24-06-2021 15:22:55000	1259,3065	400,562195	1321,4775	398,357239	229,991882	1916,9113	50,025738	-95,295341
3517	24-06-2021 15:23:00000	1265,8947	403,923737	1328,7751	397,982819	229,775696	1929,2683	49,993782	-95,267776
3518	24-06-2021 15:23:05000	1263,5684	401,799042	1325,9138	398,338745	229,981186	1923,4462	49,969479	-95,297928
3519	24-06-2021 15:23:10000	1252,7471	406,814758	1317,1459	398,606506	230,135788	1909,4166	49,987034	-95,110725
3520	24-06-2021 15:23:15000	1251,0756	401,016296	1313,7748	398,580231	230,120621	1904,6779	50,020409	-95,227554
3521	24-06-2021 15:23:20000	1261,6022	409,415833	1326,3715	398,2034	229,903046	1924,8661	50,019421	-95,116806
3522	24-06-2021 15:23:25000	1257,9988	401,771179	1320,5988	398,429565	230,033615	1915,3109	50,019447	-95,259727
3523	24-06-2021 15:23:30000	1260,5751	404,949646	1324,0219	398,313568	229,966644	1920,7998	50,020294	-95,208031
3524	24-06-2021 15:23:35000	1251,8322	390,266479	1311,2557	399,39447	230,590729	1897,4772	50,048103	-95,468193
3525	24-06-2021 15:23:40000	1256,5388	387,911957	1315,0535	399,662506	230,745483	1902,2621	50,064404	-95,5504
3526	24-06-2021 15:23:45000	1270,1558	398,05304	1331,0679	399,36554	230,57402	1926,8065	50,029465	-95,423813
3527	24-06-2021 15:23:50000	1257,6882	407,415314	1322,0315	399,862274	230,860809	1911,4601	50,015903	-95,133011
3528	24-06-2021 15:23:55000	1258,5122	395,030731	1319,0536	399,862091	230,860703	1907,1389	50,010719	-95,41024
3529	24-06-2021 15:24:00000	1266,4431	394,0112	1326,3195	399,657196	230,742401	1918,6886	49,989777	-95,485535
3530	24-06-2021 15:24:05000	1262,0385	396,272339	1322,7898	399,824036	230,838745	1912,7035	49,974522	-95,407333
3531	24-06-2021 15:24:10000	1258,027	392,267426	1317,7654	400,273163	231,098053	1903,3502	49,974453	-95,46669
3532	24-06-2021 15:24:15000	1256,6486	402,411926	1319,5078	399,759644	230,801559	1908,3296	49,977207	-95,23616
3533	24-06-2021 15:24:20000	1264,8922	396,636871	1325,6218	399,787781	230,81781	1917,0492	49,96394	-95,418785
3534	24-06-2021 15:24:25000	1258,2377	393,265472	1318,2639	399,691589	230,762268	1906,7786	49,957493	-95,446571
3535	24-06-2021 15:24:30000	1253,1605	398,391113	1314,9626	400,033997	230,959961	1900,364	49,977692	-95,300087
3536	24-06-2021 15:24:35000	1253,1913	398,56897	1315,0459	400,038513	230,962555	1900,4854	50,013309	-95,296394

3537	24-06-2021 15:24:40000	1260,0986	397,991608	1321,4559	399,935425	230,903061	1910,2136	50,030682	-95,356834
3538	24-06-2021 15:24:45000	1263,5148	401,642578	1325,8153	399,38562	230,585617	1919,0959	50,007923	-95,300964
3539	24-06-2021 15:24:50000	1267,0095	396,841614	1327,7035	399,450195	230,62291	1921,5549	49,969547	-95,428658
3540	24-06-2021 15:24:55000	1263,4258	389,404846	1322,0743	399,794922	230,821945	1911,7527	49,952213	-95,563889
3541	24-06-2021 15:25:00000	1256,9067	403,982147	1320,2334	399,761536	230,802643	1909,329	49,965195	-95,203377
3542	24-06-2021 15:25:05000	1257,979	398,402832	1319,5591	399,582123	230,699066	1909,0549	49,960667	-95,33329
3543	24-06-2021 15:25:10000	1261,6852	394,667847	1321,9728	399,589111	230,70311	1912,4933	49,955765	-95,439568
3544	24-06-2021 15:25:15000	1261,6848	397,911621	1322,9445	399,472992	230,636063	1914,4677	49,949738	-95,369438
3545	24-06-2021 15:25:20000	1252,2063	400,455597	1314,6808	400,171844	231,039551	1899,2734	49,966496	-95,24794
3546	24-06-2021 15:25:25000	1251,085	396,10495	1312,2928	400,033051	230,959412	1896,4365	49,996441	-95,3358
3547	24-06-2021 15:25:30000	1260,552	392,523041	1320,2522	399,645264	230,735535	1909,7456	49,988728	-95,478127
3548	24-06-2021 15:25:35000	1265,2262	397,452576	1326,1847	399,564575	230,68895	1918,7209	49,963058	-95,403465
3549	24-06-2021 15:25:40000	1259,0789	392,504395	1318,8402	399,874725	230,868011	1906,6912	49,957905	-95,468651
3550	24-06-2021 15:25:45000	1255,5469	391,979767	1315,3121	400,18277	231,045868	1900,1456	49,973804	-95,456192
3551	24-06-2021 15:25:50000	1253,0823	393,765228	1313,4939	400,441895	231,195465	1896,3126	50,003376	-95,400688
3552	24-06-2021 15:25:55000	1260,3879	395,71701	1321,0487	399,98465	230,931473	1909,3214	50,006187	-95,408134
3553	24-06-2021 15:26:00000	1262,6808	400,203217	1324,585	400,14328	231,023071	1913,6957	49,996124	-95,326523
3554	24-06-2021 15:26:05000	1254,3737	394,668274	1314,9967	400,191193	231,05072	1899,6423	50,008633	-95,38987
3555	24-06-2021 15:26:10000	1257,4113	396,52005	1318,4504	400,234192	231,075531	1904,3916	50,013287	-95,370392
3556	24-06-2021 15:26:15000	1260,2971	399,065521	1321,969	400,253479	231,08667	1909,3497	50,008121	-95,334846
3557	24-06-2021 15:26:20000	1260,7277	395,688782	1321,3644	400,28479	231,104752	1908,3922	49,997143	-95,411049
3558	24-06-2021 15:26:25000	1265,0167	394,560486	1325,1209	400,072632	230,982269	1914,7897	49,970875	-95,464256
3559	24-06-2021 15:26:30000	1255,55	388,318359	1314,2288	400,174377	231,041016	1898,5986	49,970303	-95,535126
3560	24-06-2021 15:26:35000	1258,5145	405,340424	1322,1798	399,882294	230,872375	1911,4429	49,972591	-95,184814
3561	24-06-2021 15:26:40000	1259,8203	392,888763	1319,6624	399,811432	230,831451	1908,1177	49,978622	-95,465347
3562	24-06-2021 15:26:45000	1263,8792	396,607605	1324,6465	399,706787	230,771042	1915,9272	49,965137	-95,412567
3563	24-06-2021 15:26:50000	1256,5042	399,52478	1318,4926	399,851196	230,854416	1906,3269	49,972874	-95,298538
3564	24-06-2021 15:26:55000	1263,9375	395,423523	1324,348	399,302063	230,537369	1917,4404	49,945202	-95,438469
3565	24-06-2021 15:27:00000	1253,3899	401,935547	1316,2593	399,800232	230,824997	1903,3088	49,958042	-95,223633
3566	24-06-2021 15:27:05000	1262,5983	392,280609	1322,134	399,422607	230,606964	1913,5906	49,95536	-95,496994

3567	24-06-2021 15:27:10000	1257,0602	402,76944	1320,0089	399,577118	230,696182	1909,7849	49,952393	-95,231186
3568	24-06-2021 15:27:15000	1256,5959	393,349884	1316,7222	399,679749	230,755432	1904,5518	49,960503	-95,43364
3569	24-06-2021 15:27:20000	1261,6223	395,423706	1322,1387	399,579071	230,697311	1912,8153	49,958458	-95,422844
3570	24-06-2021 15:27:25000	1255,0298	400,648895	1317,429	399,537415	230,673248	1906,2714	49,968346	-95,263557
3571	24-06-2021 15:27:30000	1253,1449	392,547516	1313,1892	399,791016	230,819672	1898,9022	49,992561	-95,427605
3572	24-06-2021 15:27:35000	1261,4913	392,132751	1321,0331	399,351349	230,565842	1912,2661	49,979649	-95,49279
3573	24-06-2021 15:27:40000	1266,0037	389,338501	1324,5187	399,356079	230,568558	1917,3877	49,950783	-95,582169
3574	24-06-2021 15:27:45000	1265,5863	394,623322	1325,6834	399,771637	230,808502	1917,0964	49,922363	-95,466713
3575	24-06-2021 15:27:50000	1247,564	404,697235	1311,5624	400,146423	231,024857	1894,9204	49,961479	-95,120453
3576	24-06-2021 15:27:55000	1259,6133	401,153625	1321,9492	399,507843	230,656189	1912,8882	49,957081	-95,284538
3577	24-06-2021 15:28:00000	1262,2566	391,604309	1321,6072	399,344971	230,562149	1913,1724	49,939423	-95,509209
3578	24-06-2021 15:28:05000	1258,1417	398,137115	1319,634	399,493317	230,647797	1909,5408	49,944645	-95,34021
3579	24-06-2021 15:28:10000	1260,9143	400,334961	1322,941	399,370331	230,576797	1914,9049	49,937519	-95,311455
3580	24-06-2021 15:28:15000	1258,132	394,708557	1318,5944	399,563568	230,68837	1907,7581	49,94141	-95,414635
3581	24-06-2021 15:28:20000	1259,0219	395,809387	1319,7732	399,225311	230,493057	1911,191	49,923706	-95,396843
3582	24-06-2021 15:28:25000	1255,6241	397,234741	1316,9614	398,734894	230,209915	1908,6344	49,935547	-95,342514
3583	24-06-2021 15:28:30000	1239,6573	399,641479	1302,4835	399,157257	230,453766	1885,5383	50,010468	-95,176422
3584	24-06-2021 15:28:35000	1258,0054	412,848572	1324,0172	398,228973	229,917816	1921,1903	50,024685	-95,014282
3585	24-06-2021 15:28:40000	1271,036	407,940796	1334,8964	397,857941	229,703598	1938,6873	49,978214	-95,21608
3586	24-06-2021 15:28:45000	1260,3094	405,654114	1323,9846	398,480927	230,063278	1920,0374	49,963634	-95,190643
3587	24-06-2021 15:28:50000	1255,9065	405,205536	1319,6563	398,376953	230,003265	1914,0793	49,963501	-95,169212
3588	24-06-2021 15:28:55000	1263,0417	405,294708	1326,4758	398,023987	229,799484	1925,7036	49,951927	-95,217842
3589	24-06-2021 15:29:00000	1267,0674	394,496124	1327,0596	398,043976	229,811005	1926,4833	49,936943	-95,479317
3590	24-06-2021 15:29:05000	1260,4791	415,617279	1327,2322	398,171387	229,884567	1926,083	49,932995	-94,970505
3591	24-06-2021 15:29:10000	1249,6283	397,79776	1311,4167	398,61087	230,138306	1901,1256	49,960049	-95,288422
3592	24-06-2021 15:29:15000	1256,8676	406,192078	1320,8739	397,81488	229,678741	1918,584	49,968243	-95,154236
3593	24-06-2021 15:29:20000	1266,568	409,171844	1331,0208	397,757538	229,645645	1933,6272	49,932655	-95,157646
3594	24-06-2021 15:29:25000	1260,0546	401,049683	1322,3381	399,766296	230,805405	1912,2307	49,930668	-95,289886
3595	24-06-2021 15:29:30000	1255,8895	398,557007	1317,6139	399,540771	230,675201	1906,443	49,949829	-95,315445
3596	24-06-2021 15:29:35000	1256,8301	404,678223	1320,3735	399,408661	230,598907	1911,1841	49,955128	-95,187462

3597	24-06-2021 15:29:40000	1262,4447	392,635803	1322,0929	399,243256	230,503418	1914,5059	49,935543	-95,488358
3598	24-06-2021 15:29:45000	1257,4453	394,225555	1317,7946	399,245422	230,504669	1908,1884	49,927509	-95,420433
3599	24-06-2021 15:29:50000	1250,8593	395,253021	1311,8208	399,522003	230,664352	1898,2869	49,949425	-95,352905
3600	24-06-2021 15:29:55000	1254,4923	394,004669	1314,9109	399,664703	230,74675	1902,0944	49,962875	-95,405121
3601	24-06-2021 15:30:00000	1260,0865	387,441498	1318,3054	399,493774	230,648056	1907,7181	49,972805	-95,583817
3602	24-06-2021 15:30:05000	1265,9353	387,3703	1323,8761	399,539215	230,674301	1915,6527	49,955853	-95,623398
3603	24-06-2021 15:30:10000	1245,1498	402,679626	1308,6439	400,394806	231,168274	1889,577	50,001034	-95,148102
3604	24-06-2021 15:30:15000	1254,5114	398,222168	1316,199	400,256317	231,088318	1901,0844	50,02887	-95,313202
3605	24-06-2021 15:30:20000	1263,3446	386,383698	1321,1102	399,558685	230,685547	1911,5221	50,014885	-95,627502
3606	24-06-2021 15:30:25000	1267,6766	389,319733	1326,1124	399,634491	230,729309	1918,4036	49,989094	-95,59346
3607	24-06-2021 15:30:30000	1263,9116	388,590057	1322,2991	400,128082	231,014297	1910,5579	49,97282	-95,584396
3608	24-06-2021 15:30:35000	1262,0649	408,337616	1326,4794	399,892853	230,878464	1917,6542	49,960075	-95,143959
3609	24-06-2021 15:30:40000	1261,3824	398,971008	1322,9752	399,9646	230,919891	1912,2844	49,952374	-95,344368
3610	24-06-2021 15:30:45000	1257,3417	390,848969	1316,6893	400,200287	231,055984	1902,0704	49,956593	-95,492653
3611	24-06-2021 15:30:50000	1264,5101	395,20816	1324,8303	399,713074	230,774689	1916,0746	49,942154	-95,446953
3612	24-06-2021 15:30:55000	1257,7397	394,734955	1318,228	400,243805	231,081085	1904,1361	49,94664	-95,4114

	<b>INFORME TÉCNICO DE LA PRUEBA: “POTENCIA MÁXIMA” CENTRAL PLACILLA (revisión 1)</b> Código: PPM-CEN024-2021-CC-DCO-0	
	miércoles 08 septiembre 2021	
Mandante	Revisión 1	Proveedor

## ANEXO H (REGISTRO DE MEDICIONES DE LOS MOTORES)

316

Realiza	Francisco Gorigoitia Acuña	Revisa	Patricio Febre Cisternas	Aprueba	Coordinador Eléctrico Nacional
Cargo	Ingeniero de Proyectos	Cargo	Experto Técnico	Cargo	
Firma		Firma		Firma	
Fecha	08/09/2021	Fecha	08/09/2021	Fecha	08/09/2021

INGENIERÍA, MANTENIMIENTO Y EFICIENCIA ENERGÉTICA SPA, RUT: 76.696.552-0, Dirección: Errázuriz #1178, Oficina N° 75, Valparaíso, E-mail: [PATRICIO.FEBRE@IMEE.CL](mailto:PATRICIO.FEBRE@IMEE.CL), Contacto: +56-9-93279529, Sitio Web: [WWW.IMEE.CL](http://WWW.IMEE.CL).

H.1 REGISTRO DE MEDICIONES DEL MOTOR DE LA UNIDAD 1

Promedio			50,043	1.501,38	73,59	0,94	81,81	45,38	29,49
Item	(DD-MM-YYYY)	(HH:MM:SS,fff)	Frequency (Hz)	Engine Speed (rpm)	Oil Pressure (psi)	FP	Coolant Temperature (°C)	Aftercooler Temperature (°C)	Fuel Temperature (°C)
1	06/24/2021	10:30:06,336	50.088	1.503	74,84	0,94	81,08	45,11	24,19
2	06/24/2021	10:30:21,445	50.063	1.503	73,27	0,94	81,08	45,03	24,19
3	06/24/2021	10:30:36,408	50.125	1.504	73,88	0,94	81,21	45,06	24,32
4	06/24/2021	10:30:51,463	50.063	1.503	75,09	0,94	81,08	45,20	24,32
5	06/24/2021	10:31:06,410	50.063	1.503	74,36	0,94	81,08	45,18	24,32
6	06/24/2021	10:31:21,735	50.088	1.502	74,36	0,94	81,10	45,06	24,32
7	06/24/2021	10:31:36,713	50.038	1.502	75,09	0,94	81,22	45,09	24,44
8	06/24/2021	10:31:51,794	50.063	1.503	74,36	0,94	81,18	45,15	24,44
9	06/24/2021	10:32:06,663	50.050	1.502	74,73	0,94	81,08	45,12	24,44
10	06/24/2021	10:32:21,865	50.063	1.502	73,75	0,94	81,22	45,25	24,44
11	06/24/2021	10:32:36,740	50.063	1.503	74,02	0,94	81,22	45,25	24,44
12	06/24/2021	10:32:51,873	50.050	1.502	74,48	0,94	81,12	45,23	24,44
13	06/24/2021	10:33:07,009	50.038	1.501	72,78	0,94	81,22	45,20	24,57
14	06/24/2021	10:33:22,333	50.088	1.503	74,13	0,94	81,08	45,08	24,57
15	06/24/2021	10:33:37,221	50.050	1.502	74,5	0,94	81,22	45,17	24,57
16	06/24/2021	10:33:52,264	50.063	1.502	72,78	0,94	81,22	45,21	24,57
17	06/24/2021	10:34:07,445	50.038	1.501	74,84	0,94	81,12	45,21	24,57
18	06/24/2021	10:34:22,230	50.038	1.501	73,14	0,94	81,12	45,21	24,57
19	06/24/2021	10:34:37,582	50.063	1.502	73,52	0,94	81,12	45,07	24,69
20	06/24/2021	10:34:52,651	50.025	1.500	73,75	0,94	81,19	45,25	24,69
21	06/24/2021	10:35:07,445	50.000	1.500	74,36	0,94	81,19	45,27	24,69
22	06/24/2021	10:35:22,521	50.038	1.501	74,13	0,94	81,22	45,27	24,57
23	06/24/2021	10:35:37,656	50.038	1.502	73,53	0,94	81,22	45,31	24,69



24	06/24/2021	10:35:52,835	50.038	1.501	74,73	0,94	81,12	45,35	24,69
25	06/24/2021	10:36:07,912	50.063	1.501	73,14	0,94	81,22	45,21	24,69
26	06/24/2021	10:36:22,762	50.063	1.502	73,39	0,94	81,12	45,31	24,82
27	06/24/2021	10:36:38,089	49.988	1.500	74,75	0,94	81,11	45,33	24,82
28	06/24/2021	10:36:53,139	50.013	1.500	74,61	0,94	81,23	45,29	24,82
29	06/24/2021	10:37:08,299	50.025	1.501	73,63	0,94	81,20	45,29	24,82
30	06/24/2021	10:37:23,167	50.113	1.503	73,52	0,94	81,19	45,31	24,82
31	06/24/2021	10:37:38,110	50.075	1.502	73,63	0,94	81,12	45,24	24,95
32	06/24/2021	10:37:53,527	50.050	1.501	74,23	0,94	81,22	45,25	24,95
33	06/24/2021	10:38:08,234	50.050	1.502	74,36	0,94	81,33	45,41	24,95
34	06/24/2021	10:38:23,432	50.063	1.502	74,36	0,94	81,37	45,26	24,95
35	06/24/2021	10:38:38,486	50.150	1.504	75,22	0,94	81,37	45,24	24,95
36	06/24/2021	10:38:53,724	50.125	1.504	75,34	0,94	81,34	45,22	24,95
37	06/24/2021	10:39:08,517	50.100	1.503	73,88	0,94	81,26	45,51	25,07
38	06/24/2021	10:39:23,774	50.113	1.503	74,36	0,94	81,37	45,52	25,07
39	06/24/2021	10:39:38,830	50.038	1.501	74,48	0,94	81,37	45,54	25,07
40	06/24/2021	10:39:54,130	50.063	1.502	73,02	0,94	81,27	45,72	25,07
41	06/24/2021	10:40:08,959	50.075	1.503	73,41	0,94	81,33	45,65	25,20
42	06/24/2021	10:40:24,003	50.050	1.502	73,39	0,94	81,36	45,57	25,20
43	06/24/2021	10:40:39,005	50.038	1.502	74,13	0,94	81,36	45,64	25,20
44	06/24/2021	10:40:54,280	50.050	1.502	72,89	0,94	81,34	45,64	25,20
45	06/24/2021	10:41:09,221	50.113	1.503	73,27	0,94	81,27	45,47	25,20
46	06/24/2021	10:41:24,105	50.038	1.502	73,63	0,94	81,34	45,47	25,20
47	06/24/2021	10:41:39,437	50.050	1.502	73,27	0,94	81,26	45,54	25,20
48	06/24/2021	10:41:54,252	50.063	1.502	73,63	0,94	81,37	45,48	25,20
49	06/24/2021	10:42:09,517	50.050	1.501	74,61	0,94	81,34	45,41	25,32
50	06/24/2021	10:42:24,401	50.063	1.502	73,52	0,94	81,36	45,57	25,32
51	06/24/2021	10:42:39,459	50.075	1.503	74	0,94	81,27	45,46	25,32
52	06/24/2021	10:42:54,557	50.088	1.503	73,02	0,94	81,38	45,59	25,32
53	06/24/2021	10:43:09,494	50.050	1.502	73,88	0,94	81,41	45,63	25,32

54	06/24/2021	10:43:24,585	50.063	1.502	74,84	0,94	81,38	45,65	25,45
55	06/24/2021	10:43:39,661	50.050	1.502	73,88	0,94	81,26	45,54	25,32
56	06/24/2021	10:43:54,641	50.063	1.502	73,39	0,94	81,26	45,65	25,45
57	06/24/2021	10:44:09,606	50.113	1.502	73,75	0,94	81,36	45,58	25,45
58	06/24/2021	10:44:24,580	50.063	1.502	74,48	0,94	81,36	45,73	25,45
59	06/24/2021	10:44:39,623	50.150	1.505	75,34	0,94	81,34	45,74	25,45
60	06/24/2021	10:44:54,857	50.100	1.503	74,36	0,94	81,26	45,71	25,45
61	06/24/2021	10:45:09,711	50.113	1.503	74,73	0,94	81,36	45,77	25,45
62	06/24/2021	10:45:25,073	50.125	1.504	74,36	0,94	81,27	45,86	25,57
63	06/24/2021	10:45:39,784	50.063	1.502	74,61	0,94	81,37	45,81	25,57
64	06/24/2021	10:45:55,160	50.113	1.504	74,36	0,94	81,37	45,82	25,57
65	06/24/2021	10:46:10,167	50.125	1.504	73,88	0,94	81,36	45,89	25,57
66	06/24/2021	10:46:24,953	50.050	1.502	74,36	0,94	81,36	45,91	25,57
67	06/24/2021	10:46:40,030	50.113	1.504	72,66	0,94	81,34	45,89	25,57
68	06/24/2021	10:46:55,174	50.113	1.503	74,61	0,94	81,26	46,14	25,57
69	06/24/2021	10:47:10,375	50.113	1.504	74,48	0,94	81,38	46,11	25,57
70	06/24/2021	10:47:25,319	50.063	1.502	74	0,94	81,51	46,10	25,71
71	06/24/2021	10:47:40,463	50.100	1.503	73,88	0,94	81,48	46,25	25,71
72	06/24/2021	10:47:55,343	50.050	1.502	72,78	0,94	81,38	46,26	25,71
73	06/24/2021	10:48:10,350	50.088	1.503	74,13	0,94	81,45	46,33	25,71
74	06/24/2021	10:48:25,599	50.050	1.502	74	0,94	81,48	46,28	25,71
75	06/24/2021	10:48:40,699	50.063	1.502	75,22	0,94	81,37	46,38	25,82
76	06/24/2021	10:48:55,587	50.063	1.502	74,23	0,94	81,38	46,46	25,82
77	06/24/2021	10:49:10,715	50.050	1.502	72,41	0,94	81,48	46,37	25,82
78	06/24/2021	10:49:25,724	50.038	1.500	73,75	0,94	81,48	46,38	25,82
79	06/24/2021	10:49:40,877	50.050	1.502	74,84	0,94	81,36	46,38	25,82
80	06/24/2021	10:49:55,793	50.063	1.503	75,09	0,94	81,47	46,36	25,82
81	06/24/2021	10:50:10,772	50.013	1.500	75,22	0,94	81,51	46,56	25,82
82	06/24/2021	10:50:25,871	50.038	1.500	73,52	0,94	81,48	46,49	25,96
83	06/24/2021	10:50:41,021	50.025	1.501	74,23	0,94	81,51	46,61	25,96

84	06/24/2021	10:50:56,133	50.013	1.500	74,84	0,94	81,34	46,56	25,96
85	06/24/2021	10:51:10,989	50.075	1.502	73,63	0,94	81,51	46,48	25,96
86	06/24/2021	10:51:25,950	50.025	1.501	74,13	0,94	81,51	46,46	26,08
87	06/24/2021	10:51:40,992	50.038	1.502	73,88	0,94	81,48	46,65	26,08
88	06/24/2021	10:51:56,054	50.013	1.500	74,36	0,94	81,41	46,56	26,08
89	06/24/2021	10:52:11,147	50.013	1.501	74,13	0,94	81,48	46,65	26,08
90	06/24/2021	10:52:26,314	50.050	1.502	72,78	0,94	81,52	46,63	26,08
91	06/24/2021	10:52:41,237	50.050	1.501	73,14	0,94	81,39	46,65	26,08
92	06/24/2021	10:52:56,214	50.075	1.503	72,78	0,94	81,52	46,66	26,08
93	06/24/2021	10:53:11,225	50.000	1.500	73,52	0,94	81,39	46,65	26,08
94	06/24/2021	10:53:26,534	50.013	1.500	73,52	0,94	81,52	46,72	26,21
95	06/24/2021	10:53:41,561	50.050	1.501	72,89	0,94	81,52	46,57	26,21
96	06/24/2021	10:53:56,398	50.025	1.501	74,23	0,94	81,48	46,76	26,21
97	06/24/2021	10:54:11,354	50.038	1.502	74,13	0,94	81,41	46,76	26,21
98	06/24/2021	10:54:26,642	50.050	1.501	73,75	0,94	81,51	46,72	26,21
99	06/24/2021	10:54:41,623	50.025	1.501	74,23	0,94	81,41	46,72	26,33
100	06/24/2021	10:54:56,389	50.000	1.500	73,27	0,94	81,41	46,63	26,33
101	06/24/2021	10:55:11,563	50.050	1.502	73,63	0,94	81,52	46,82	26,33
102	06/24/2021	10:55:26,692	50.050	1.502	74,84	0,94	81,48	46,74	26,33
103	06/24/2021	10:55:41,685	50.050	1.502	74,36	0,94	81,52	46,88	26,33
104	06/24/2021	10:55:56,742	50.000	1.500	73,75	0,94	81,41	46,63	26,33
105	06/24/2021	10:56:11,772	49.988	1.500	74	0,94	81,38	46,76	26,46
106	06/24/2021	10:56:26,957	50.050	1.502	73,02	0,94	81,39	46,50	26,46
107	06/24/2021	10:56:41,789	50.013	1.500	73,39	0,94	81,37	46,74	26,46
108	06/24/2021	10:56:56,992	50.063	1.502	73,75	0,94	81,39	46,62	26,46
109	06/24/2021	10:57:11,974	49.988	1.500	73,52	0,94	81,41	46,74	26,46
110	06/24/2021	10:57:26,910	50.013	1.501	72,53	0,94	81,41	46,76	26,46
111	06/24/2021	10:57:42,123	50.100	1.503	74,36	0,94	81,48	46,76	26,46
112	06/24/2021	10:57:57,241	50.063	1.502	74,36	0,94	81,51	46,73	26,58
113	06/24/2021	10:58:12,295	50.088	1.502	74,84	0,94	81,51	46,74	26,58

114	06/24/2021	10:58:27,388	50.063	1.501	73,27	0,94	81,52	46,74	26,46
115	06/24/2021	10:58:42,245	50.075	1.503	73,02	0,94	81,41	46,71	26,58
116	06/24/2021	10:58:57,232	50.050	1.502	72,89	0,94	81,37	46,74	26,58
117	06/24/2021	10:59:12,464	50.138	1.504	74,61	0,94	81,37	46,74	26,58
118	06/24/2021	10:59:27,462	50.038	1.502	73,02	0,94	81,51	46,76	26,58
119	06/24/2021	10:59:42,391	50.100	1.504	72,41	0,94	81,52	46,73	26,58
120	06/24/2021	10:59:57,689	50.038	1.502	73,02	0,94	81,52	46,78	26,71
121	06/24/2021	11:00:12,619	50.088	1.503	73,52	0,94	81,41	46,59	26,71
122	06/24/2021	11:00:27,569	50.100	1.504	73,02	0,94	81,52	46,62	26,71
123	06/24/2021	11:00:42,504	50.050	1.502	73,27	0,94	81,41	46,74	26,71
124	06/24/2021	11:00:57,575	50.063	1.502	74	0,94	81,39	46,93	26,83
125	06/24/2021	11:01:12,882	50.075	1.502	74,13	0,94	81,52	46,85	26,71
126	06/24/2021	11:01:27,922	50.063	1.502	74,36	0,94	81,52	46,69	26,83
127	06/24/2021	11:01:42,666	50.063	1.502	73,14	0,94	81,52	46,76	26,83
128	06/24/2021	11:01:57,802	50.013	1.501	74,61	0,94	81,49	46,71	26,83
129	06/24/2021	11:02:12,804	49.975	1.500	74	0,94	81,52	46,72	26,83
130	06/24/2021	11:02:27,861	50.038	1.501	75,22	0,94	81,51	46,84	26,83
131	06/24/2021	11:02:42,831	50.025	1.501	74,13	0,94	81,49	46,84	26,83
132	06/24/2021	11:02:57,960	50.025	1.500	73,75	0,94	81,42	46,68	26,96
133	06/24/2021	11:03:13,121	50.063	1.502	73,02	0,94	81,66	46,82	27,08
134	06/24/2021	11:03:28,197	50.013	1.501	74,84	0,94	81,63	46,88	27,08
135	06/24/2021	11:03:43,074	50.038	1.501	74,36	0,94	81,53	46,89	27,08
136	06/24/2021	11:03:58,131	49.975	1.500	73,75	0,94	81,63	46,96	27,08
137	06/24/2021	11:04:13,320	50.025	1.501	74,48	0,94	81,67	47,05	27,08
138	06/24/2021	11:04:28,233	50.050	1.502	74,61	0,94	81,66	47,02	27,21
139	06/24/2021	11:04:43,380	50.050	1.501	73,27	0,94	81,56	46,88	27,21
140	06/24/2021	11:04:58,308	50.063	1.502	73,14	0,94	81,63	47,09	27,21
141	06/24/2021	11:05:13,437	49.988	1.500	74	0,94	81,63	47,19	27,21
142	06/24/2021	11:05:28,528	50.013	1.501	74	0,94	81,67	47,11	27,21
143	06/24/2021	11:05:43,759	50.088	1.503	73,27	0,94	81,56	47,11	27,33

144	06/24/2021	11:05:58,711	50.038	1.501	73,63	0,94	81,63	47,16	27,33
145	06/24/2021	11:06:13,669	50.075	1.502	73,75	0,94	81,56	47,17	27,33
146	06/24/2021	11:06:28,794	50.013	1.500	73,75	0,94	81,69	47,16	27,33
147	06/24/2021	11:06:43,543	50.075	1.502	73,52	0,94	81,56	47,23	27,33
148	06/24/2021	11:06:58,630	50.038	1.502	74,23	0,94	81,78	47,10	27,33
149	06/24/2021	11:07:13,817	50.088	1.503	73,27	0,94	81,64	47,17	27,33
150	06/24/2021	11:07:28,859	50.050	1.502	74,36	0,94	81,67	47,19	27,33
151	06/24/2021	11:07:43,750	49.975	1.499	73,52	0,94	81,67	47,26	27,33
152	06/24/2021	11:07:58,968	50.075	1.503	74,13	0,94	81,63	47,16	27,33
153	06/24/2021	11:08:13,976	50.100	1.504	73,63	0,94	81,56	47,02	27,47
154	06/24/2021	11:08:28,820	50.088	1.502	74,97	0,94	81,66	47,16	27,47
155	06/24/2021	11:08:44,003	50.063	1.502	74,36	0,94	81,57	47,12	27,47
156	06/24/2021	11:08:58,980	50.038	1.502	73,52	0,94	81,82	47,19	27,59
157	06/24/2021	11:09:14,276	50.125	1.504	73,88	0,94	81,82	47,16	27,59
158	06/24/2021	11:09:29,143	50.100	1.504	73,39	0,94	81,67	47,24	27,59
159	06/24/2021	11:09:44,352	50.050	1.502	72,78	0,94	81,64	47,33	27,59
160	06/24/2021	11:09:59,246	50.138	1.504	73,39	0,94	81,78	47,24	27,59
161	06/24/2021	11:10:14,289	50.113	1.504	74,36	0,94	81,71	47,17	27,59
162	06/24/2021	11:10:29,330	50.113	1.504	73,75	0,94	81,78	47,24	27,72
163	06/24/2021	11:10:44,332	50.113	1.505	73,88	0,94	81,82	47,24	27,72
164	06/24/2021	11:10:59,294	50.175	1.505	74,48	0,94	81,82	47,33	27,72
165	06/24/2021	11:11:14,331	50.125	1.504	73,39	0,94	81,82	47,32	27,72
166	06/24/2021	11:11:29,741	50.100	1.504	74,48	0,94	81,82	47,24	27,84
167	06/24/2021	11:11:44,667	50.075	1.502	74	0,94	81,82	47,21	27,72
168	06/24/2021	11:11:59,551	50.150	1.504	74,36	0,94	81,82	47,35	27,72
169	06/24/2021	11:12:14,696	50.125	1.504	74,84	0,94	81,82	47,19	27,84
170	06/24/2021	11:12:29,674	50.138	1.504	72,78	0,94	81,82	47,24	27,84
171	06/24/2021	11:12:44,848	50.088	1.503	74,48	0,94	81,68	47,31	27,72
172	06/24/2021	11:12:59,873	50.125	1.503	73,02	0,94	81,68	47,32	27,84
173	06/24/2021	11:13:14,912	50.100	1.504	74,48	0,94	81,79	47,36	27,84

174	06/24/2021	11:13:29,861	50.125	1.504	74,23	0,94	81,67	47,27	27,84
175	06/24/2021	11:13:44,828	50.125	1.504	73,63	0,94	81,71	47,27	27,84
176	06/24/2021	11:14:00,146	50.125	1.503	72,66	0,94	81,63	47,24	27,84
177	06/24/2021	11:14:15,232	50.100	1.503	74	0,94	81,63	47,36	27,84
178	06/24/2021	11:14:30,129	50.138	1.504	74,36	0,94	81,67	47,34	27,97
179	06/24/2021	11:14:45,315	50.125	1.504	74,48	0,94	81,53	47,41	27,97
180	06/24/2021	11:15:00,304	50.150	1.504	73,14	0,94	81,56	47,33	27,97
181	06/24/2021	11:15:15,305	50.075	1.502	74	0,94	81,56	47,53	27,97
182	06/24/2021	11:15:30,186	50.100	1.503	73,77	0,94	81,67	47,41	27,97
183	06/24/2021	11:15:45,401	50.088	1.502	73,39	0,94	81,65	47,38	27,97
184	06/24/2021	11:16:00,713	50.138	1.504	74	0,94	81,63	47,46	27,97
185	06/24/2021	11:16:15,558	50.113	1.503	73,52	0,94	81,63	47,46	27,97
186	06/24/2021	11:16:30,498	50.175	1.506	74,97	0,94	81,67	47,47	27,97
187	06/24/2021	11:16:45,492	50.125	1.504	74,23	0,94	81,56	47,55	27,97
188	06/24/2021	11:17:00,704	50.150	1.504	74,97	0,94	81,53	47,42	27,97
189	06/24/2021	11:17:15,624	50.100	1.504	73,63	0,94	81,65	47,41	27,97
190	06/24/2021	11:17:30,644	50.113	1.503	73,88	0,94	81,50	47,53	28,09
191	06/24/2021	11:17:45,896	50.163	1.505	73,88	0,94	81,52	47,55	28,09
192	06/24/2021	11:18:00,823	50.088	1.503	74,84	0,94	81,52	47,57	28,09
193	06/24/2021	11:18:15,841	50.188	1.506	73,02	0,94	81,52	47,47	28,09
194	06/24/2021	11:18:31,080	50.088	1.504	74	0,94	81,56	47,66	28,09
195	06/24/2021	11:18:46,043	50.200	1.506	74,73	0,94	81,56	47,66	28,09
196	06/24/2021	11:19:01,166	50.188	1.506	73,52	0,94	81,54	47,66	28,09
197	06/24/2021	11:19:15,976	50.138	1.504	73,88	0,94	81,67	47,66	28,22
198	06/24/2021	11:19:31,178	50.138	1.504	73,63	0,94	81,67	47,59	28,22
199	06/24/2021	11:19:46,187	50.138	1.505	74,13	0,94	81,56	47,57	28,22
200	06/24/2021	11:20:01,123	50.163	1.505	73,63	0,94	81,66	47,57	28,22
201	06/24/2021	11:20:16,300	50.138	1.504	74	0,94	81,61	47,67	28,22
202	06/24/2021	11:20:31,408	50.125	1.504	74,61	0,94	81,68	47,59	28,22
203	06/24/2021	11:20:46,328	50.125	1.504	74,84	0,94	81,68	47,53	28,34

204	06/24/2021	11:21:01,285	50.150	1.504	73,63	0,94	81,82	47,49	28,34
205	06/24/2021	11:21:16,419	50.138	1.503	72,89	0,94	81,82	47,59	28,34
206	06/24/2021	11:21:31,505	50.138	1.504	74,61	0,94	81,82	47,67	28,34
207	06/24/2021	11:21:46,549	50.138	1.504	73,52	0,94	81,79	47,62	28,34
208	06/24/2021	11:22:01,644	50.113	1.504	74,73	0,94	81,82	47,66	28,34
209	06/24/2021	11:22:16,568	50.088	1.502	74,48	0,94	81,68	47,61	28,34
210	06/24/2021	11:22:31,478	50.175	1.505	74	0,94	81,68	47,61	28,34
211	06/24/2021	11:22:46,467	50.125	1.503	74	0,94	81,71	47,62	28,34
212	06/24/2021	11:23:01,653	50.075	1.502	72,28	0,94	81,68	47,53	28,34
213	06/24/2021	11:23:16,765	50.113	1.503	74,73	0,94	81,82	47,70	28,47
214	06/24/2021	11:23:31,781	50.113	1.504	72,53	0,94	81,82	47,77	28,47
215	06/24/2021	11:23:46,848	50.138	1.504	74,36	0,94	81,71	47,66	28,47
216	06/24/2021	11:24:01,861	50.088	1.503	72,41	0,94	81,82	47,59	28,47
217	06/24/2021	11:24:16,977	50.125	1.505	73,88	0,94	81,82	47,67	28,58
218	06/24/2021	11:24:31,792	50.150	1.504	74,97	0,94	81,79	47,55	28,58
219	06/24/2021	11:24:46,878	50.113	1.504	73,02	0,94	81,82	47,52	28,47
220	06/24/2021	11:25:02,174	50.150	1.505	73,52	0,94	81,83	47,67	28,58
221	06/24/2021	11:25:17,011	50.150	1.505	73,75	0,94	81,74	47,66	28,58
222	06/24/2021	11:25:32,128	50.125	1.504	72,78	0,94	81,87	47,83	28,58
223	06/24/2021	11:25:47,032	50.075	1.502	74	0,94	81,82	47,85	28,58
224	06/24/2021	11:26:02,314	50.100	1.503	72,89	0,94	81,82	47,64	28,58
225	06/24/2021	11:26:17,230	50.163	1.505	74,13	0,94	81,71	47,73	28,58
226	06/24/2021	11:26:32,287	50.113	1.503	73,02	0,94	81,71	47,61	28,58
227	06/24/2021	11:26:47,197	50.050	1.502	72,89	0,94	81,82	47,76	28,58
228	06/24/2021	11:27:02,279	50.100	1.504	74,13	0,94	81,82	47,72	28,58
229	06/24/2021	11:27:17,368	50.100	1.503	73,52	0,94	81,82	47,67	28,58
230	06/24/2021	11:27:32,526	50.125	1.504	74,23	0,94	81,79	47,73	28,70
231	06/24/2021	11:27:47,602	50.063	1.503	73,63	0,94	81,82	47,63	28,70
232	06/24/2021	11:28:02,379	50.100	1.503	74,23	0,94	81,82	47,59	28,70
233	06/24/2021	11:28:17,366	50.100	1.503	74,23	0,94	81,82	47,87	28,70

234	06/24/2021	11:28:32,456	50.100	1.504	74,48	0,94	81,82	47,97	28,70
235	06/24/2021	11:28:47,550	50.075	1.503	73,39	0,94	81,72	48,03	28,70
236	06/24/2021	11:29:02,675	50.100	1.503	74,13	0,94	81,82	48,16	28,70
237	06/24/2021	11:29:17,719	50.050	1.501	74,36	0,94	81,82	48,26	28,81
238	06/24/2021	11:29:32,862	50.050	1.502	72,78	0,94	81,82	48,22	28,81
239	06/24/2021	11:29:47,717	50.113	1.504	73,02	0,94	81,82	48,23	28,81
240	06/24/2021	11:30:02,846	50.075	1.502	74,61	0,94	81,71	48,33	28,81
241	06/24/2021	11:30:17,787	50.075	1.502	73,88	0,94	81,78	48,34	28,81
242	06/24/2021	11:30:33,007	50.075	1.502	74,23	0,94	81,79	48,24	28,81
243	06/24/2021	11:30:47,866	50.075	1.503	73,75	0,94	81,82	48,24	28,81
244	06/24/2021	11:31:02,807	50.063	1.503	73,88	0,94	81,79	48,21	28,81
245	06/24/2021	11:31:17,914	50.075	1.502	74,13	0,94	81,96	48,23	28,81
246	06/24/2021	11:31:32,867	50.075	1.502	73,14	0,94	81,93	48,15	28,81
247	06/24/2021	11:31:47,965	50.075	1.502	73,39	0,94	81,87	47,93	28,81
248	06/24/2021	11:32:03,131	50.088	1.503	73,52	0,94	81,74	48,04	28,92
249	06/24/2021	11:32:17,991	50.075	1.502	74,48	0,94	81,87	47,96	28,92
250	06/24/2021	11:32:33,332	50.050	1.501	74,36	0,94	81,82	48,04	28,92
251	06/24/2021	11:32:48,319	50.063	1.502	74	0,94	81,96	48,07	28,92
252	06/24/2021	11:33:03,114	50.075	1.502	73,88	0,94	81,86	48,07	28,92
253	06/24/2021	11:33:18,297	50.088	1.503	72,53	0,94	81,72	47,96	28,92
254	06/24/2021	11:33:33,345	50.038	1.501	74	0,94	81,92	42,77	28,92
255	06/24/2021	11:33:48,480	50.088	1.503	74,13	0,94	81,82	42,79	28,92
256	06/24/2021	11:34:03,271	50.063	1.502	74,36	0,94	81,92	42,59	28,92
257	06/24/2021	11:34:18,398	50.063	1.502	72,89	0,94	81,85	42,79	28,92
258	06/24/2021	11:34:33,331	50.138	1.504	73,27	0,94	81,79	42,73	28,92
259	06/24/2021	11:34:48,572	50.063	1.502	73,02	0,94	81,85	42,79	29,04
260	06/24/2021	11:35:03,525	50.063	1.502	73,39	0,94	81,79	42,99	29,04
261	06/24/2021	11:35:18,523	50.025	1.500	72,41	0,94	81,82	42,94	29,04
262	06/24/2021	11:35:33,495	50.113	1.504	72,41	0,94	81,82	42,65	29,04
263	06/24/2021	11:35:48,534	50.150	1.505	74,13	0,94	81,82	42,79	29,04



264	06/24/2021	11:36:03,776	50.063	1.502	74,23	0,94	81,85	42,66	29,04
265	06/24/2021	11:36:18,622	50.050	1.502	73,63	0,94	81,93	42,98	29,04
266	06/24/2021	11:36:33,718	50.038	1.501	74,61	0,94	81,83	42,81	29,04
267	06/24/2021	11:36:48,739	50.038	1.501	74,23	0,94	81,93	42,98	29,04
268	06/24/2021	11:37:03,805	50.138	1.504	73,63	0,94	81,79	42,79	29,04
269	06/24/2021	11:37:18,815	50.038	1.501	73,27	0,94	81,72	42,99	29,04
270	06/24/2021	11:37:33,987	50.050	1.502	73,63	0,94	81,82	42,82	29,15
271	06/24/2021	11:37:49,022	50.088	1.502	73,27	0,94	81,82	42,97	29,04
272	06/24/2021	11:38:03,886	50.050	1.502	72,17	0,94	81,87	43,04	29,04
273	06/24/2021	11:38:19,109	50.050	1.502	74,61	0,94	81,86	42,94	29,04
274	06/24/2021	11:38:34,120	50.125	1.503	72,89	0,94	81,83	42,87	29,15
275	06/24/2021	11:38:49,255	50.100	1.504	74,84	0,94	81,83	43,06	29,04
276	06/24/2021	11:39:04,325	50.088	1.502	73,88	0,94	81,97	42,92	29,15
277	06/24/2021	11:39:19,231	50.088	1.503	72,53	0,94	81,93	42,83	29,15
278	06/24/2021	11:39:34,415	50.113	1.503	74,97	0,94	81,96	42,92	29,15
279	06/24/2021	11:39:49,469	50.050	1.502	73,63	0,94	81,93	43,13	29,15
280	06/24/2021	11:40:04,325	50.025	1.500	74,61	0,94	81,83	43,16	29,15
281	06/24/2021	11:40:19,625	50.025	1.501	74,13	0,94	81,93	42,86	29,15
282	06/24/2021	11:40:34,579	50.025	1.500	73,88	0,94	81,85	43,16	29,15
283	06/24/2021	11:40:49,700	50.013	1.500	74,84	0,94	81,93	43,14	29,15
284	06/24/2021	11:41:04,792	50.075	1.502	73,63	0,94	81,93	42,98	29,26
285	06/24/2021	11:41:19,592	50.075	1.502	74,48	0,94	81,83	43,15	29,15
286	06/24/2021	11:41:34,785	50.038	1.501	73,88	0,94	81,85	43,16	29,15
287	06/24/2021	11:41:49,867	50.000	1.500	73,88	0,94	81,96	43,32	29,15
288	06/24/2021	11:42:04,808	49.913	1.498	72,17	0,94	81,93	43,22	29,26
289	06/24/2021	11:42:19,748	49.938	1.497	74,36	0,94	81,96	43,24	29,26
290	06/24/2021	11:42:34,841	49.950	1.499	74,23	0,94	81,83	43,04	29,26
291	06/24/2021	11:42:50,095	49.913	1.497	73,52	0,94	81,93	43,12	29,26
292	06/24/2021	11:43:04,966	49.850	1.496	72,78	0,94	81,93	43,21	29,26
293	06/24/2021	11:43:20,007	49.963	1.499	74,13	0,94	81,86	43,31	29,26

294	06/24/2021	11:43:34,897	49.888	1.497	72,78	0,94	81,97	43,26	29,26
295	06/24/2021	11:43:50,122	49.925	1.498	73,39	0,94	81,93	43,01	29,26
296	06/24/2021	11:44:04,983	49.925	1.498	74,61	0,94	81,85	42,99	29,26
297	06/24/2021	11:44:20,248	49.888	1.496	74,23	0,94	81,83	43,16	29,26
298	06/24/2021	11:44:35,170	49.938	1.498	72,28	0,94	81,83	43,36	29,37
299	06/24/2021	11:44:50,309	49.888	1.497	73,02	0,94	81,82	42,95	29,37
300	06/24/2021	11:45:05,185	49.900	1.498	73,02	0,94	81,83	43,13	29,37
301	06/24/2021	11:45:20,462	49.950	1.500	74,84	0,94	81,93	43,32	29,37
302	06/24/2021	11:45:35,573	49.938	1.498	73,63	0,94	81,82	43,15	29,37
303	06/24/2021	11:45:50,365	49.900	1.497	74,36	0,94	81,96	43,18	29,37
304	06/24/2021	11:46:05,366	49.913	1.497	72,41	0,94	81,87	43,23	29,37
305	06/24/2021	11:46:20,671	49.938	1.498	74,23	0,94	81,96	43,21	29,48
306	06/24/2021	11:46:35,516	49.963	1.499	73,02	0,94	81,97	43,23	29,48
307	06/24/2021	11:46:50,612	49.913	1.497	73,39	0,94	81,97	43,21	29,48
308	06/24/2021	11:47:05,680	49.950	1.498	74	0,94	81,93	43,27	29,48
309	06/24/2021	11:47:20,574	50.000	1.500	73,27	0,94	81,93	43,38	29,48
310	06/24/2021	11:47:35,836	49.925	1.498	74,36	0,94	81,83	43,38	29,48
311	06/24/2021	11:47:50,749	49.963	1.499	72,89	0,94	81,76	43,21	29,48
312	06/24/2021	11:48:05,987	49.963	1.498	74,23	0,94	81,87	43,29	29,48
313	06/24/2021	11:48:20,935	49.938	1.498	72,41	0,94	81,82	43,17	29,48
314	06/24/2021	11:48:35,919	50.025	1.501	73,88	0,94	81,93	43,21	29,59
315	06/24/2021	11:48:50,993	50.038	1.501	73,02	0,94	81,97	43,24	29,59
316	06/24/2021	11:49:05,958	49.988	1.500	72,66	0,94	81,82	43,19	29,59
317	06/24/2021	11:49:21,114	50.013	1.501	73,63	0,94	81,97	43,17	29,59
318	06/24/2021	11:49:35,931	50.050	1.502	73,02	0,94	81,97	43,14	29,59
319	06/24/2021	11:49:50,946	50.075	1.503	72,66	0,94	81,93	43,41	29,59
320	06/24/2021	11:50:06,275	50.050	1.502	73,39	0,94	81,96	43,13	29,59
321	06/24/2021	11:50:21,184	50.025	1.501	72,78	0,94	81,97	43,46	29,59
322	06/24/2021	11:50:36,378	50.000	1.500	74	0,94	81,97	43,49	29,59
323	06/24/2021	11:50:51,310	49.963	1.499	73,75	0,94	81,87	43,52	29,59

324	06/24/2021	11:51:06,539	50.000	1.500	73,63	0,94	81,93	43,36	29,59
325	06/24/2021	11:51:21,450	49.913	1.498	72,53	0,94	81,93	43,46	29,59
326	06/24/2021	11:51:36,440	49.988	1.500	73,02	0,94	81,83	43,46	29,71
327	06/24/2021	11:51:51,654	50.050	1.501	72,89	0,94	81,97	43,16	29,71
328	06/24/2021	11:52:06,696	50.063	1.502	73,88	0,94	81,97	43,44	29,71
329	06/24/2021	11:52:21,634	50.050	1.501	74	0,94	81,86	43,21	29,71
330	06/24/2021	11:52:36,668	50.013	1.501	73,63	0,94	81,97	43,41	29,71
331	06/24/2021	11:52:51,709	50.000	1.500	74	0,94	81,93	43,27	29,71
332	06/24/2021	11:53:06,787	50.025	1.501	74	0,94	81,93	43,53	29,71
333	06/24/2021	11:53:21,657	50.075	1.502	74	0,94	81,94	43,55	29,71
334	06/24/2021	11:53:36,844	50.063	1.502	73,52	0,94	82,07	43,27	29,71
335	06/24/2021	11:53:52,060	50.050	1.502	74,36	0,94	81,97	43,63	29,71
336	06/24/2021	11:54:06,818	50.050	1.501	73,27	0,94	81,97	43,53	29,71
337	06/24/2021	11:54:21,785	50.063	1.502	74,84	0,94	81,82	43,32	29,82
338	06/24/2021	11:54:37,021	50.025	1.500	72,66	0,94	81,97	43,58	29,82
339	06/24/2021	11:54:51,993	50.088	1.502	72,53	0,94	81,97	43,54	29,82
340	06/24/2021	11:55:07,097	50.075	1.502	74,13	0,94	81,97	43,38	29,82
341	06/24/2021	11:55:22,200	50.025	1.501	74,23	0,94	81,96	43,30	29,82
342	06/24/2021	11:55:37,438	50.050	1.501	73,88	0,94	81,97	43,52	29,82
343	06/24/2021	11:55:52,340	50.038	1.501	73,39	0,94	81,87	43,36	29,82
344	06/24/2021	11:56:07,289	50.038	1.501	73,14	0,94	81,97	43,49	29,82
345	06/24/2021	11:56:22,462	50.075	1.502	72,89	0,94	81,93	43,61	29,82
346	06/24/2021	11:56:37,351	50.050	1.502	73,88	0,94	81,93	43,42	29,82
347	06/24/2021	11:56:52,376	50.038	1.501	73,02	0,94	81,97	43,37	29,82
348	06/24/2021	11:57:07,572	50.038	1.501	73,88	0,94	81,96	43,71	29,82
349	06/24/2021	11:57:22,373	50.025	1.501	73,63	0,94	81,96	43,48	29,93
350	06/24/2021	11:57:37,562	50.075	1.502	74,36	0,94	81,97	43,80	29,93
351	06/24/2021	11:57:52,597	50.063	1.503	74	0,94	81,96	43,66	29,93
352	06/24/2021	11:58:07,708	50.088	1.504	72,17	0,94	81,97	43,52	29,93
353	06/24/2021	11:58:22,670	50.013	1.500	72,41	0,94	81,83	43,73	29,93

354	06/24/2021	11:58:37,869	50.025	1.500	74,36	0,94	81,97	43,43	29,93
355	06/24/2021	11:58:52,747	50.088	1.503	73,63	0,94	81,82	43,68	29,93
356	06/24/2021	11:59:07,949	50.013	1.501	72,41	0,94	81,97	43,72	29,93
357	06/24/2021	11:59:22,834	50.013	1.500	74	0,94	81,93	43,72	29,93
358	06/24/2021	11:59:37,822	50.063	1.502	73,52	0,94	81,93	43,55	29,93
359	06/24/2021	11:59:52,870	50.038	1.501	73,27	0,94	81,96	43,36	29,93
360	06/24/2021	12:00:08,130	50.000	1.500	73,63	0,94	81,96	43,41	29,93
361	06/24/2021	12:00:22,968	50.038	1.502	72,41	0,94	81,96	43,38	29,93
362	06/24/2021	12:00:38,024	50.025	1.501	74	0,94	81,86	43,62	29,93
363	06/24/2021	12:00:53,014	50.075	1.503	73,75	0,94	81,83	43,47	29,93
364	06/24/2021	12:01:08,453	50.013	1.500	74,48	0,94	81,97	43,67	29,93
365	06/24/2021	12:01:23,287	50.038	1.502	73,39	0,94	81,82	43,77	30,04
366	06/24/2021	12:01:38,312	50.063	1.502	73,27	0,94	81,82	43,77	29,93
367	06/24/2021	12:01:53,283	50.000	1.500	73,75	0,94	81,97	43,66	29,93
368	06/24/2021	12:02:08,550	49.988	1.500	73,88	0,94	81,87	43,73	30,04
369	06/24/2021	12:02:23,446	50.063	1.502	74,36	0,94	81,96	43,58	30,04
370	06/24/2021	12:02:38,347	50.025	1.501	73,75	0,94	81,96	43,67	30,04
371	06/24/2021	12:02:53,524	50.050	1.502	73,27	0,94	81,93	43,44	30,04
372	06/24/2021	12:03:08,494	50.013	1.501	73,63	0,94	81,87	43,50	30,16
373	06/24/2021	12:03:23,674	50.050	1.501	73,88	0,94	81,96	43,64	30,16
374	06/24/2021	12:03:38,802	50.038	1.502	74,23	0,94	81,93	43,78	30,04
375	06/24/2021	12:03:53,904	50.063	1.503	73,75	0,94	81,97	43,68	30,04
376	06/24/2021	12:04:08,628	49.975	1.499	73,27	0,94	81,93	43,62	30,04
377	06/24/2021	12:04:23,708	50.075	1.503	74,48	0,94	81,93	43,54	30,04
378	06/24/2021	12:04:38,950	50.050	1.501	74,13	0,94	81,97	43,56	30,04
379	06/24/2021	12:04:53,944	50.038	1.501	73,02	0,94	81,93	43,50	30,04
380	06/24/2021	12:05:09,050	50.050	1.501	74,36	0,94	81,93	43,57	30,04
381	06/24/2021	12:05:23,938	49.938	1.499	72,89	0,94	81,72	43,60	30,04
382	06/24/2021	12:05:39,096	50.025	1.501	74,36	0,94	81,93	43,68	30,16
383	06/24/2021	12:05:54,030	50.038	1.501	73,88	0,94	81,86	43,83	30,16

384	06/24/2021	12:06:09,082	49.988	1.499	73,88	0,94	81,87	43,77	30,16
385	06/24/2021	12:06:24,022	49.963	1.499	72,78	0,94	81,83	43,93	30,16
386	06/24/2021	12:06:39,439	49.988	1.500	73,88	0,94	81,83	43,91	30,16
387	06/24/2021	12:06:54,140	50.025	1.501	72,41	0,94	81,97	43,82	30,16
388	06/24/2021	12:07:09,374	50.038	1.501	74,13	0,94	81,85	43,83	30,16
389	06/24/2021	12:07:24,526	50.013	1.501	72,66	0,94	81,96	43,76	30,16
390	06/24/2021	12:07:39,358	50.050	1.501	73,75	0,94	81,97	43,87	30,16
391	06/24/2021	12:07:54,666	49.963	1.499	73,75	0,94	81,96	43,88	30,16
392	06/24/2021	12:08:09,427	49.988	1.499	74,13	0,94	81,97	43,90	30,16
393	06/24/2021	12:08:24,581	50.050	1.502	74	0,94	81,83	43,92	30,16
394	06/24/2021	12:08:39,718	49.988	1.500	73,02	0,94	81,96	43,92	30,16
395	06/24/2021	12:08:54,765	49.975	1.499	72,53	0,94	81,83	43,84	30,16
396	06/24/2021	12:09:09,830	49.975	1.499	72,89	0,94	81,97	43,73	30,27
397	06/24/2021	12:09:24,726	49.963	1.499	73,88	0,94	81,86	43,66	30,27
398	06/24/2021	12:09:39,999	49.950	1.499	72,41	0,94	81,87	43,79	30,27
399	06/24/2021	12:09:54,794	50.038	1.502	74,48	0,94	81,97	43,87	30,27
400	06/24/2021	12:10:09,999	50.038	1.502	72,28	0,94	81,96	43,79	30,27
401	06/24/2021	12:10:24,868	49.950	1.499	74,13	0,94	81,82	44,01	30,27
402	06/24/2021	12:10:40,149	49.975	1.500	73,02	0,94	81,97	43,97	30,27
403	06/24/2021	12:10:54,961	49.975	1.499	73,75	0,94	81,96	43,98	30,27
404	06/24/2021	12:11:10,234	50.050	1.501	72,89	0,94	81,82	43,76	30,27
405	06/24/2021	12:11:25,310	50.013	1.500	73,88	0,94	81,82	43,73	30,27
406	06/24/2021	12:11:40,311	50.000	1.500	72,78	0,94	81,96	43,79	30,27
407	06/24/2021	12:11:55,278	50.063	1.502	73,39	0,94	81,93	44,04	30,27
408	06/24/2021	12:12:10,173	50.013	1.501	73,27	0,94	81,93	43,86	30,27
409	06/24/2021	12:12:25,260	50.025	1.500	72,53	0,94	81,96	44,02	30,27
410	06/24/2021	12:12:40,296	49.988	1.499	73,88	0,94	81,83	44,01	30,38
411	06/24/2021	12:12:55,351	50.000	1.500	73,02	0,94	81,83	43,93	30,27
412	06/24/2021	12:13:10,514	50.063	1.502	74,23	0,94	81,83	44,01	30,38
413	06/24/2021	12:13:25,315	49.975	1.499	72,89	0,94	81,96	44,01	30,38

414	06/24/2021	12:13:40,508	49.988	1.500	73,39	0,94	81,87	43,89	30,38
415	06/24/2021	12:13:55,406	50.088	1.502	72,78	0,94	81,87	43,91	30,27
416	06/24/2021	12:14:10,645	50.013	1.500	73,52	0,94	81,82	43,93	30,27
417	06/24/2021	12:14:25,856	50.025	1.500	73,52	0,94	81,97	43,91	30,38
418	06/24/2021	12:14:40,722	50.050	1.502	72,41	0,94	81,83	43,88	30,38
419	06/24/2021	12:14:55,733	50.000	1.500	73,52	0,94	81,96	43,68	30,38
420	06/24/2021	12:15:10,831	50.050	1.501	73,14	0,94	81,97	43,84	30,38
421	06/24/2021	12:15:25,917	50.075	1.503	74,36	0,94	81,82	43,92	30,38
422	06/24/2021	12:15:40,940	50.013	1.500	74	0,94	81,83	44,00	30,38
423	06/24/2021	12:15:56,023	50.050	1.501	72,53	0,94	81,87	43,89	30,38
424	06/24/2021	12:16:11,042	50.150	1.504	73,14	0,94	81,82	43,75	30,38
425	06/24/2021	12:16:25,982	49.975	1.499	73,39	0,94	81,87	44,02	30,38
426	06/24/2021	12:16:41,249	50.063	1.501	74,36	0,94	81,81	43,89	30,38
427	06/24/2021	12:16:56,241	50.038	1.501	72,41	0,94	81,82	44,03	30,49
428	06/24/2021	12:17:11,245	50.075	1.503	72,89	0,94	81,85	43,94	30,38
429	06/24/2021	12:17:26,288	50.038	1.501	73,14	0,94	81,67	43,95	30,38
430	06/24/2021	12:17:41,171	50.088	1.502	73,52	0,94	81,79	43,94	30,38
431	06/24/2021	12:17:56,488	50.125	1.504	72,53	0,94	81,82	44,01	30,38
432	06/24/2021	12:18:11,249	50.063	1.502	72,78	0,94	81,82	43,72	30,38
433	06/24/2021	12:18:26,395	50.088	1.503	73,39	0,94	81,82	43,88	30,38
434	06/24/2021	12:18:41,452	50.063	1.502	74,73	0,94	81,78	43,80	30,38
435	06/24/2021	12:18:56,535	50.063	1.502	72,89	0,94	81,82	43,95	30,38
436	06/24/2021	12:19:11,656	50.063	1.502	75,09	0,94	81,71	44,04	30,49
437	06/24/2021	12:19:26,474	50.138	1.504	73,63	0,94	81,68	43,98	30,49
438	06/24/2021	12:19:41,479	50.100	1.503	73,75	0,94	81,82	44,02	30,49
439	06/24/2021	12:19:56,747	50.038	1.501	74,73	0,94	81,79	43,84	30,49
440	06/24/2021	12:20:11,563	50.063	1.501	73,27	0,94	81,82	43,95	30,49
441	06/24/2021	12:20:26,834	50.100	1.503	72,28	0,94	81,82	44,04	30,49
442	06/24/2021	12:20:41,648	50.075	1.502	73,75	0,94	81,82	43,88	30,38
443	06/24/2021	12:20:56,892	50.075	1.503	74,48	0,94	81,82	44,01	30,38

444	06/24/2021	12:21:11,795	50.075	1.502	74,13	0,94	81,74	43,76	30,49
445	06/24/2021	12:21:26,763	50.075	1.503	73,39	0,94	81,93	44,06	30,38
446	06/24/2021	12:21:41,893	50.125	1.504	73,75	0,94	81,82	44,04	30,49
447	06/24/2021	12:21:57,113	50.088	1.503	73,52	0,94	81,83	44,13	30,49
448	06/24/2021	12:22:12,080	50.013	1.501	72,78	0,94	81,93	44,10	30,49
449	06/24/2021	12:22:26,935	50.100	1.503	73,14	0,94	81,93	43,82	30,61
450	06/24/2021	12:22:42,264	50.088	1.503	73,02	0,94	81,83	43,80	30,61
451	06/24/2021	12:22:57,156	50.063	1.502	73,52	0,94	81,93	44,04	30,61
452	06/24/2021	12:23:12,376	50.075	1.502	74,48	0,94	81,93	43,88	30,61
453	06/24/2021	12:23:27,207	50.063	1.501	73,88	0,94	81,93	43,86	30,61
454	06/24/2021	12:23:42,243	50.100	1.503	74,36	0,94	81,97	43,93	30,61
455	06/24/2021	12:23:57,310	50.025	1.501	72,17	0,94	81,96	43,93	30,61
456	06/24/2021	12:24:12,481	50.075	1.503	74	0,94	81,96	43,92	30,61
457	06/24/2021	12:24:27,479	50.075	1.502	74,36	0,94	81,97	43,88	30,61
458	06/24/2021	12:24:42,615	50.038	1.501	73,14	0,94	81,97	43,78	30,61
459	06/24/2021	12:24:57,556	50.100	1.503	73,39	0,94	81,97	43,91	30,49
460	06/24/2021	12:25:12,753	50.075	1.502	72,78	0,94	81,96	43,75	30,61
461	06/24/2021	12:25:27,767	50.100	1.503	73,52	0,94	81,87	43,77	30,61
462	06/24/2021	12:25:42,831	50.063	1.502	73,39	0,94	81,97	43,92	30,61
463	06/24/2021	12:25:57,751	50.025	1.501	73,88	0,94	81,83	43,92	30,61
464	06/24/2021	12:26:12,998	50.075	1.503	74,36	0,94	81,97	43,96	30,72
465	06/24/2021	12:26:27,897	50.075	1.503	73,75	0,94	81,82	43,97	30,72
466	06/24/2021	12:26:43,120	50.100	1.503	73,14	0,94	81,97	43,95	30,61
467	06/24/2021	12:26:57,965	50.063	1.502	72,05	0,94	81,87	43,81	30,61
468	06/24/2021	12:27:13,285	50.075	1.503	73,39	0,94	81,97	43,93	30,61
469	06/24/2021	12:27:28,070	50.050	1.502	74,23	0,94	81,93	43,91	30,61
470	06/24/2021	12:27:43,101	50.063	1.502	73,52	0,94	81,97	43,77	30,61
471	06/24/2021	12:27:58,177	50.063	1.501	73,39	0,94	81,96	43,92	30,61
472	06/24/2021	12:28:13,347	50.063	1.502	73,88	0,94	81,93	44,01	30,61
473	06/24/2021	12:28:28,291	50.025	1.500	74,61	0,94	81,82	43,94	30,61

474	06/24/2021	12:28:43,242	50.050	1.501	74,61	0,94	81,97	43,83	30,72
475	06/24/2021	12:28:58,599	50.100	1.504	74,23	0,94	81,97	43,77	30,61
476	06/24/2021	12:29:13,343	50.088	1.503	73,52	0,94	81,93	43,94	30,72
477	06/24/2021	12:29:28,613	50.088	1.503	73,02	0,94	81,93	43,93	30,72
478	06/24/2021	12:29:43,685	50.100	1.503	74,23	0,94	81,97	43,94	30,72
479	06/24/2021	12:29:58,693	50.025	1.500	74,36	0,94	81,93	43,79	30,61
480	06/24/2021	12:30:13,509	50.025	1.501	74	0,94	81,97	43,87	30,61
481	06/24/2021	12:30:28,750	50.050	1.502	73,14	0,94	81,97	43,90	30,72
482	06/24/2021	12:30:43,820	50.063	1.503	72,53	0,94	81,97	43,96	30,72
483	06/24/2021	12:30:58,592	50.025	1.500	74,23	0,94	81,87	44,02	30,61
484	06/24/2021	12:31:13,752	50.038	1.501	72,41	0,94	81,97	43,98	30,72
485	06/24/2021	12:31:28,857	50.025	1.500	73,52	0,94	82,08	43,92	30,72
486	06/24/2021	12:31:43,985	50.025	1.501	73,88	0,94	81,96	44,01	30,72
487	06/24/2021	12:31:58,938	50.050	1.501	74	0,94	81,97	44,11	30,72
488	06/24/2021	12:32:14,202	50.088	1.502	74,84	0,94	81,97	44,04	30,72
489	06/24/2021	12:32:29,040	50.013	1.500	72,17	0,94	81,83	44,11	30,72
490	06/24/2021	12:32:44,228	50.038	1.500	73,88	0,94	81,97	44,12	30,72
491	06/24/2021	12:32:59,118	50.000	1.500	73,39	0,94	81,97	44,02	30,72
492	06/24/2021	12:33:14,031	50.038	1.501	72,17	0,94	81,83	43,91	30,72
493	06/24/2021	12:33:29,328	50.063	1.501	73,02	0,94	81,97	43,89	30,72
494	06/24/2021	12:33:44,340	50.050	1.502	74	0,94	81,93	43,83	30,72
495	06/24/2021	12:33:59,415	50.000	1.499	72,78	0,94	82,07	43,86	30,72
496	06/24/2021	12:34:14,303	50.013	1.500	74,48	0,94	81,98	43,84	30,72
497	06/24/2021	12:34:29,320	50.050	1.502	73,63	0,94	81,98	43,84	30,72
498	06/24/2021	12:34:44,640	50.025	1.501	73,75	0,94	81,98	43,73	30,72
499	06/24/2021	12:34:59,520	50.025	1.500	73,14	0,94	82,08	43,72	30,83
500	06/24/2021	12:35:14,533	50.050	1.502	74	0,94	82,08	43,88	30,83
501	06/24/2021	12:35:29,622	50.063	1.502	73,63	0,94	82,08	44,01	30,83
502	06/24/2021	12:35:44,591	50.038	1.501	74,13	0,94	82,02	43,91	30,83
503	06/24/2021	12:35:59,506	50.025	1.501	74,13	0,94	82,11	43,86	30,83



504	06/24/2021	12:36:14,738	50.038	1.501	73,14	0,94	82,11	43,97	30,72
505	06/24/2021	12:36:29,760	50.025	1.501	72,53	0,94	82,08	43,89	30,83
506	06/24/2021	12:36:44,885	50.000	1.500	73,63	0,94	82,01	43,95	30,83
507	06/24/2021	12:36:59,708	50.038	1.501	72,28	0,94	82,08	44,01	30,83
508	06/24/2021	12:37:14,784	50.050	1.501	73,14	0,94	82,08	43,97	30,72
509	06/24/2021	12:37:29,971	50.075	1.502	73,02	0,94	82,12	44,01	30,83
510	06/24/2021	12:37:44,980	50.038	1.501	73,14	0,94	82,12	43,82	30,83
511	06/24/2021	12:38:00,131	50.038	1.501	74,48	0,94	81,99	43,80	30,83
512	06/24/2021	12:38:15,105	50.075	1.502	74,48	0,94	82,08	43,82	30,83
513	06/24/2021	12:38:30,203	50.050	1.501	72,66	0,94	81,98	43,99	30,83
514	06/24/2021	12:38:45,184	50.063	1.502	72,17	0,94	82,12	44,17	30,83
515	06/24/2021	12:39:00,252	50.000	1.500	72,89	0,94	82,01	44,18	30,83
516	06/24/2021	12:39:15,299	50.063	1.502	74,23	0,94	81,99	43,94	30,83
517	06/24/2021	12:39:30,197	50.025	1.501	73,52	0,94	82,08	44,01	30,83
518	06/24/2021	12:39:45,379	50.013	1.500	73,73	0,94	82,12	44,02	30,83
519	06/24/2021	12:40:00,283	50.075	1.502	74,84	0,94	82,08	44,12	30,83
520	06/24/2021	12:40:15,400	50.013	1.500	73,39	0,94	82,11	44,26	30,83
521	06/24/2021	12:40:30,473	50.050	1.502	73,02	0,94	82,12	44,04	30,83
522	06/24/2021	12:40:45,569	50.050	1.502	74	0,94	82,12	44,17	30,83
523	06/24/2021	12:41:00,549	50.025	1.501	73,63	0,94	82,12	44,06	30,83
524	06/24/2021	12:41:15,716	50.025	1.502	73,39	0,94	82,02	44,08	30,83
525	06/24/2021	12:41:30,686	50.013	1.500	73,75	0,94	82,02	44,20	30,83
526	06/24/2021	12:41:45,773	50.063	1.502	73,88	0,94	82,02	44,19	30,83
527	06/24/2021	12:42:00,668	49.988	1.500	73,88	0,94	82,08	44,23	30,83
528	06/24/2021	12:42:15,891	49.988	1.500	72,53	0,94	82,08	44,06	30,83
529	06/24/2021	12:42:30,853	50.013	1.500	73,5	0,94	82,07	44,19	30,83
530	06/24/2021	12:42:46,066	50.025	1.501	73,52	0,94	82,12	44,27	30,83
531	06/24/2021	12:43:00,941	50.038	1.502	72,41	0,94	82,08	44,36	30,83
532	06/24/2021	12:43:16,039	50.025	1.501	74	0,94	82,11	44,34	30,83
533	06/24/2021	12:43:30,939	49.988	1.500	73,02	0,94	82,11	44,44	30,83

534	06/24/2021	12:43:46,020	50.075	1.503	74,73	0,94	82,12	44,39	30,83
535	06/24/2021	12:44:01,046	50.025	1.501	73,25	0,94	82,12	44,59	30,83
536	06/24/2021	12:44:16,107	50.000	1.500	73,52	0,94	82,22	44,58	30,83
537	06/24/2021	12:44:31,174	50.050	1.502	72,03	0,94	82,08	44,64	30,94
538	06/24/2021	12:44:46,278	49.975	1.499	73,02	0,94	82,27	44,57	30,83
539	06/24/2021	12:45:01,216	50.025	1.502	72,53	0,94	82,12	44,36	30,83
540	06/24/2021	12:45:16,322	50.038	1.501	73,14	0,94	82,16	44,49	30,83
541	06/24/2021	12:45:31,408	50.000	1.500	73,63	0,94	82,22	44,48	30,83
542	06/24/2021	12:45:46,510	50.038	1.502	74,13	0,94	82,16	44,53	30,83
543	06/24/2021	12:46:01,629	49.975	1.500	73,52	0,94	82,22	44,64	30,83
544	06/24/2021	12:46:16,441	49.963	1.499	72,78	0,94	82,26	44,49	30,83
545	06/24/2021	12:46:31,442	50.050	1.501	73,02	0,94	82,02	44,66	30,83
546	06/24/2021	12:46:46,595	49.950	1.499	74,36	0,94	82,16	44,61	30,83
547	06/24/2021	12:47:01,734	50.000	1.500	74,61	0,94	82,21	44,76	30,94
548	06/24/2021	12:47:16,657	50.025	1.501	74,22	0,94	81,98	44,82	30,94
549	06/24/2021	12:47:31,826	49.963	1.499	73,86	0,94	82,08	44,72	30,94
550	06/24/2021	12:47:46,614	49.975	1.500	72,89	0,94	82,12	44,77	30,94
551	06/24/2021	12:48:01,772	50.025	1.501	73,63	0,94	82,12	44,82	30,94
552	06/24/2021	12:48:16,994	49.950	1.499	73,5	0,94	82,12	44,83	30,94
553	06/24/2021	12:48:31,937	50.075	1.502	74	0,94	82,08	44,69	30,94
554	06/24/2021	12:48:46,746	50.000	1.500	72,05	0,94	82,12	44,63	30,94
555	06/24/2021	12:49:02,105	49.963	1.499	73,14	0,94	82,12	44,63	30,94
556	06/24/2021	12:49:16,973	49.988	1.499	73,63	0,94	82,12	44,53	30,94
557	06/24/2021	12:49:32,159	49.988	1.500	73,86	0,94	82,08	44,68	30,94
558	06/24/2021	12:49:46,905	50.050	1.502	72,53	0,94	82,08	44,83	30,94
559	06/24/2021	12:50:02,269	50.013	1.501	73,73	0,94	82,12	45,00	30,94
560	06/24/2021	12:50:17,265	50.013	1.500	73,73	0,94	82,11	44,96	30,94
561	06/24/2021	12:50:32,265	50.013	1.500	73,13	0,94	82,11	45,11	30,94
562	06/24/2021	12:50:47,376	49.988	1.500	73,73	0,94	82,01	45,03	30,94
563	06/24/2021	12:51:02,267	49.975	1.499	73,63	0,94	82,12	45,06	30,94

564	06/24/2021	12:51:17,282	50.013	1.501	74,34	0,94	81,99	45,20	31,06
565	06/24/2021	12:51:32,196	49.988	1.499	73,13	0,94	82,11	45,18	30,94
566	06/24/2021	12:51:47,393	49.963	1.499	74,23	0,94	82,02	45,06	30,94
567	06/24/2021	12:52:02,263	49.988	1.500	72,66	0,94	82,01	45,09	30,94
568	06/24/2021	12:52:17,374	50.013	1.500	74,23	0,94	82,02	45,15	30,94
569	06/24/2021	12:52:32,416	50.013	1.500	73,86	0,94	82,12	45,12	30,94
570	06/24/2021	12:52:47,564	50.013	1.500	73,98	0,94	82,08	45,25	30,94
571	06/24/2021	12:53:02,697	50.050	1.502	71,91	0,94	82,13	45,25	30,94
572	06/24/2021	12:53:17,970	49.950	1.498	73,98	0,94	82,12	45,23	30,94
573	06/24/2021	12:53:32,634	49.938	1.499	73,98	0,94	82,27	45,20	30,94
574	06/24/2021	12:53:47,718	49.988	1.500	73,88	0,94	82,16	45,08	31,06
575	06/24/2021	12:54:02,958	50.050	1.502	72,41	0,94	82,26	45,17	31,06
576	06/24/2021	12:54:17,931	50.013	1.500	71,92	0,94	82,24	45,21	31,06
577	06/24/2021	12:54:32,864	50.000	1.500	72,66	0,94	82,16	45,21	31,06
578	06/24/2021	12:54:48,009	50.063	1.502	72,77	0,94	82,23	45,21	31,06
579	06/24/2021	12:55:02,920	49.988	1.500	72,16	0,94	82,13	45,07	30,94
580	06/24/2021	12:55:17,903	50.025	1.501	72,52	0,94	82,16	45,25	31,06
581	06/24/2021	12:55:33,122	50.000	1.500	74	0,94	82,13	45,27	31,06
582	06/24/2021	12:55:48,131	50.025	1.501	74,36	0,94	82,26	45,27	31,06
583	06/24/2021	12:56:03,244	50.038	1.501	74,11	0,94	82,22	45,31	31,06
584	06/24/2021	12:56:18,389	50.075	1.502	73,73	0,94	82,02	45,35	31,06
585	06/24/2021	12:56:33,150	50.088	1.504	73	0,94	82,12	45,21	31,06
586	06/24/2021	12:56:48,203	50.000	1.501	72,39	0,94	82,12	45,31	31,06
587	06/24/2021	12:57:03,224	50.025	1.501	72,28	0,94	82,11	45,33	31,06
588	06/24/2021	12:57:18,315	50.063	1.503	73,61	0,94	82,12	45,29	31,16
589	06/24/2021	12:57:33,306	50.050	1.502	74,59	0,94	82,11	45,29	31,06
590	06/24/2021	12:57:48,518	50.075	1.502	72,78	0,94	82,02	45,31	31,16
591	06/24/2021	12:58:03,483	50.100	1.503	73,61	0,94	82,12	45,24	31,16
592	06/24/2021	12:58:18,754	50.000	1.500	72,64	0,94	82,07	45,25	31,06
593	06/24/2021	12:58:33,708	50.100	1.502	72,88	0,94	82,12	45,41	31,16

594	06/24/2021	12:58:48,577	50.038	1.501	72,77	0,94	82,08	45,26	31,06
595	06/24/2021	12:59:03,672	50.088	1.503	73,39	0,94	82,12	45,24	31,06
596	06/24/2021	12:59:18,774	50.075	1.502	73,39	0,94	82,12	45,22	31,06
597	06/24/2021	12:59:33,749	50.113	1.503	72,77	0,94	82,12	45,51	31,06
598	06/24/2021	12:59:49,081	50.050	1.501	72,77	0,94	82,12	45,52	31,06
599	06/24/2021	13:00:03,829	50.038	1.502	74,11	0,94	82,12	45,54	31,16
600	06/24/2021	13:00:18,948	50.063	1.502	72,77	0,94	82,12	45,72	31,16
601	06/24/2021	13:00:34,053	50.138	1.504	73,86	0,94	82,12	45,65	31,16
602	06/24/2021	13:00:48,909	50.088	1.503	74,22	0,94	82,08	45,57	31,16
603	06/24/2021	13:01:03,931	50.050	1.501	73,73	0,94	82,02	45,64	31,16
604	06/24/2021	13:01:19,262	50.050	1.502	74,22	0,94	82,11	45,64	31,16
605	06/24/2021	13:01:34,111	50.088	1.503	74,22	0,94	82,11	45,47	31,16
606	06/24/2021	13:01:49,158	50.025	1.500	74,23	0,94	82,07	45,47	31,16
607	06/24/2021	13:02:04,200	50.113	1.504	72,89	0,94	81,97	45,54	31,16
608	06/24/2021	13:02:19,258	50.000	1.500	72,28	0,94	81,96	45,48	31,16
609	06/24/2021	13:02:34,551	50.100	1.503	72,52	0,94	81,96	45,41	31,16
610	06/24/2021	13:02:49,461	50.025	1.501	72,16	0,94	81,97	45,57	31,16
611	06/24/2021	13:03:04,636	50.038	1.501	73,98	0,94	81,87	45,46	31,16
612	06/24/2021	13:03:19,531	50.050	1.501	74,34	0,94	81,93	45,59	31,16
613	06/24/2021	13:03:34,428	50.025	1.501	72,16	0,94	81,93	45,63	31,16
614	06/24/2021	13:03:49,726	50.075	1.503	73,13	0,94	81,93	45,65	31,16
615	06/24/2021	13:04:04,730	50.025	1.501	72,77	0,94	81,87	45,54	31,06
616	06/24/2021	13:04:19,543	49.988	1.499	73,86	0,94	81,93	45,65	31,06
617	06/24/2021	13:04:34,816	50.063	1.502	73,25	0,94	81,87	45,58	31,06
618	06/24/2021	13:04:49,643	50.075	1.503	72,64	0,94	81,93	45,73	31,06
619	06/24/2021	13:05:04,757	50.000	1.500	73,38	0,94	81,96	45,74	31,06
620	06/24/2021	13:05:19,873	50.063	1.503	73,73	0,94	81,97	45,71	31,06
621	06/24/2021	13:05:34,837	50.025	1.501	74,59	0,94	81,93	45,77	31,06
622	06/24/2021	13:05:49,780	50.050	1.502	74,22	0,94	81,97	45,86	31,06
623	06/24/2021	13:06:05,019	50.000	1.501	72,64	0,94	81,86	45,81	31,06

624	06/24/2021	13:06:20,122	50.063	1.502	73,86	0,94	81,83	45,82	31,16
625	06/24/2021	13:06:35,024	50.100	1.503	72,64	0,94	81,96	45,89	31,16
626	06/24/2021	13:06:50,178	50.025	1.501	73,5	0,94	81,93	45,91	31,16
627	06/24/2021	13:07:05,237	50.013	1.501	72,39	0,94	81,97	45,89	31,06
628	06/24/2021	13:07:20,289	50.063	1.502	73,13	0,94	81,97	46,14	31,16
629	06/24/2021	13:07:35,253	50.050	1.501	72,16	0,94	81,96	46,11	31,06
630	06/24/2021	13:07:50,300	50.038	1.502	72,88	0,94	81,93	46,10	31,06
631	06/24/2021	13:08:05,200	50.050	1.502	73,13	0,94	81,96	46,25	31,06
632	06/24/2021	13:08:20,259	50.100	1.503	73,73	0,94	82,01	46,26	31,06
633	06/24/2021	13:08:35,268	50.088	1.503	72,64	0,94	82,08	46,33	31,06
634	06/24/2021	13:08:50,453	50.088	1.503	73,86	0,94	82,01	46,28	31,06
635	06/24/2021	13:09:05,379	50.063	1.502	73,86	0,94	82,01	46,38	31,06
636	06/24/2021	13:09:20,722	49.988	1.500	73	0,94	82,08	46,46	30,94
637	06/24/2021	13:09:35,566	50.063	1.502	72,64	0,94	82,12	46,37	31,06
638	06/24/2021	13:09:50,744	50.000	1.501	74,47	0,94	82,11	46,38	31,06
639	06/24/2021	13:10:05,792	50.075	1.502	73,98	0,94	82,07	46,38	31,16
640	06/24/2021	13:10:20,661	50.038	1.501	74,11	0,94	82,02	46,36	31,16
641	06/24/2021	13:10:35,808	50.100	1.503	73,25	0,94	82,12	46,56	31,16
642	06/24/2021	13:10:50,877	50.000	1.500	73,13	0,94	82,11	46,49	31,06
643	06/24/2021	13:11:05,808	50.013	1.501	72,77	0,94	82,08	46,61	31,06
644	06/24/2021	13:11:20,954	50.038	1.501	73,13	0,94	81,97	46,56	31,06
645	06/24/2021	13:11:36,074	50.088	1.503	73,25	0,94	82,02	46,48	31,06
646	06/24/2021	13:11:50,883	50.013	1.500	73,5	0,94	82,12	46,46	31,06
647	06/24/2021	13:12:06,028	50.088	1.502	72,77	0,94	82,12	46,65	31,06
648	06/24/2021	13:12:21,157	50.000	1.500	72,77	0,94	82,16	46,56	31,06
649	06/24/2021	13:12:35,967	50.050	1.501	74,11	0,94	82,13	46,65	31,06
650	06/24/2021	13:12:51,164	50.025	1.501	73,38	0,94	82,26	46,63	31,06
651	06/24/2021	13:13:06,313	50.050	1.503	73,13	0,94	82,24	46,65	31,16
652	06/24/2021	13:13:21,461	50.000	1.500	72,41	0,94	82,23	46,66	31,16
653	06/24/2021	13:13:36,232	49.988	1.500	73,73	0,94	82,23	46,65	31,16

654	06/24/2021	13:13:51,226	50.000	1.501	74,72	0,94	82,16	46,72	31,16
655	06/24/2021	13:14:06,308	50.063	1.502	73,38	0,94	82,26	46,57	31,06
656	06/24/2021	13:14:21,534	50.025	1.501	73,61	0,94	82,13	46,76	31,06
657	06/24/2021	13:14:36,284	50.000	1.500	74,34	0,94	82,13	46,76	31,06
658	06/24/2021	13:14:51,526	49.988	1.499	72,88	0,94	82,12	46,72	31,06
659	06/24/2021	13:15:06,367	50.050	1.501	72,27	0,94	82,13	46,72	31,06
660	06/24/2021	13:15:21,597	49.950	1.499	73,13	0,94	82,23	46,63	31,06
661	06/24/2021	13:15:36,790	50.063	1.501	73,73	0,94	82,13	46,82	31,06
662	06/24/2021	13:15:51,796	49.975	1.499	73,61	0,94	82,13	46,74	31,06
663	06/24/2021	13:16:06,817	49.963	1.499	73,73	0,94	82,13	46,88	31,06
664	06/24/2021	13:16:21,655	50.013	1.500	72,64	0,94	82,26	46,63	31,06
665	06/24/2021	13:16:36,935	50.050	1.501	73,5	0,94	82,27	46,76	31,06
666	06/24/2021	13:16:51,890	50.025	1.500	73,61	0,94	82,26	46,50	31,06
667	06/24/2021	13:17:06,850	50.000	1.500	73,61	0,94	82,26	46,74	31,06
668	06/24/2021	13:17:21,842	49.988	1.500	73,98	0,94	82,23	46,62	31,06
669	06/24/2021	13:17:36,958	50.000	1.500	73,98	0,94	82,16	46,74	31,06
670	06/24/2021	13:17:51,953	50.063	1.502	74,47	0,94	82,27	46,76	31,06
671	06/24/2021	13:18:06,935	50.038	1.501	73,5	0,94	82,27	46,76	31,06
672	06/24/2021	13:18:22,083	50.088	1.502	73	0,94	82,16	46,73	31,06
673	06/24/2021	13:18:37,088	50.025	1.500	73,5	0,94	82,16	46,74	30,94
674	06/24/2021	13:18:52,145	49.938	1.499	73,13	0,94	82,26	46,74	31,06
675	06/24/2021	13:19:07,032	49.975	1.499	74,22	0,94	82,16	46,71	30,94
676	06/24/2021	13:19:22,076	49.988	1.500	74,34	0,94	82,13	46,74	31,06
677	06/24/2021	13:19:37,120	50.050	1.501	73,73	0,94	82,16	46,74	31,06
678	06/24/2021	13:19:52,168	49.975	1.500	73,38	0,94	82,12	46,76	30,94
679	06/24/2021	13:20:07,223	49.963	1.499	73,98	0,94	82,12	46,73	31,06
680	06/24/2021	13:20:22,191	49.950	1.499	74,47	0,94	82,12	46,78	31,06
681	06/24/2021	13:20:37,540	49.975	1.499	72,03	0,94	82,12	46,59	31,06
682	06/24/2021	13:20:52,310	50.000	1.500	72,64	0,94	82,08	46,62	31,06
683	06/24/2021	13:21:07,624	50.000	1.500	72,27	0,94	82,12	46,74	31,06

684	06/24/2021	13:21:22,596	50.025	1.501	73,86	0,94	82,08	46,93	30,94
685	06/24/2021	13:21:37,673	50.000	1.500	73	0,94	81,98	46,85	30,94
686	06/24/2021	13:21:52,519	50.000	1.501	73,38	0,94	82,12	46,69	30,94
687	06/24/2021	13:22:07,590	49.963	1.499	73,73	0,94	82,08	46,76	30,94
688	06/24/2021	13:22:22,681	49.975	1.499	73,73	0,94	82,02	46,71	30,94
689	06/24/2021	13:22:37,640	49.938	1.498	73,13	0,94	82,02	46,72	30,94
690	06/24/2021	13:22:52,718	50.050	1.502	73,38	0,94	82,08	46,84	30,94
691	06/24/2021	13:23:07,752	49.975	1.500	73,38	0,94	82,02	46,84	30,94
692	06/24/2021	13:23:22,709	50.000	1.500	72,52	0,94	82,08	46,68	30,94
693	06/24/2021	13:23:38,110	49.988	1.500	72,64	0,94	82,12	46,82	30,94
694	06/24/2021	13:23:52,982	50.013	1.501	74,34	0,94	82,11	46,88	30,94
695	06/24/2021	13:24:07,966	50.063	1.502	73,73	0,94	82,02	46,89	30,94
696	06/24/2021	13:24:23,032	50.000	1.500	73,38	0,94	82,12	46,96	30,94
697	06/24/2021	13:24:38,244	50.050	1.501	73,73	0,94	82,08	47,05	30,94
698	06/24/2021	13:24:53,278	50.063	1.502	73,13	0,94	82,02	47,02	30,94
699	06/24/2021	13:25:08,085	49.913	1.497	72,52	0,94	81,98	46,88	30,94
700	06/24/2021	13:25:23,302	50.000	1.500	72,39	0,94	82,12	47,09	30,94
701	06/24/2021	13:25:38,229	49.975	1.500	73,5	0,94	82,12	47,19	30,94
702	06/24/2021	13:25:53,382	50.075	1.503	72,39	0,94	82,08	47,11	31,06
703	06/24/2021	13:26:08,392	50.013	1.500	73	0,94	82,08	47,11	30,94
704	06/24/2021	13:26:23,519	50.063	1.502	74,34	0,94	81,98	47,16	31,06
705	06/24/2021	13:26:38,324	50.013	1.500	72,64	0,94	82,12	47,17	30,94
706	06/24/2021	13:26:53,522	50.013	1.501	73,73	0,94	82,11	47,16	31,06
707	06/24/2021	13:27:08,448	50.013	1.501	73,86	0,94	82,12	47,23	31,06
708	06/24/2021	13:27:23,608	50.013	1.500	73,38	0,94	82,01	47,10	31,06
709	06/24/2021	13:27:38,657	50.063	1.502	73,5	0,94	82,08	47,17	30,94
710	06/24/2021	13:27:53,870	50.025	1.501	74,22	0,94	82,01	47,19	30,94
711	06/24/2021	13:28:08,645	50.025	1.501	72,27	0,94	82,02	47,26	30,94
712	06/24/2021	13:28:23,691	50.013	1.501	72,03	0,94	81,99	47,16	30,94
713	06/24/2021	13:28:38,815	50.050	1.502	73	0,94	82,11	47,02	30,94

714	06/24/2021	13:28:53,917	50.025	1.501	73,98	0,94	82,11	47,16	30,83
715	06/24/2021	13:29:08,785	50.038	1.501	73,38	0,94	82,02	47,12	30,94
716	06/24/2021	13:29:23,885	50.038	1.502	73,73	0,94	82,08	47,19	30,94
717	06/24/2021	13:29:38,976	50.050	1.502	73,25	0,94	81,98	47,16	30,94
718	06/24/2021	13:29:53,968	49.988	1.499	72,64	0,94	81,97	47,24	30,94
719	06/24/2021	13:30:08,941	50.013	1.501	74,22	0,94	82,02	47,33	30,94
720	06/24/2021	13:30:24,175	50.050	1.502	73,38	0,94	82,07	47,24	30,94
721	06/24/2021	13:30:39,106	50.063	1.502	73,13	0,94	82,11	47,17	30,94
722	06/24/2021	13:30:54,175	50.088	1.502	73,98	0,94	82,11	47,24	30,94
723	06/24/2021	13:31:09,204	50.050	1.502	73,73	0,94	82,12	47,24	30,94
724	06/24/2021	13:31:24,208	50.013	1.500	72,64	0,94	82,12	47,33	30,94
725	06/24/2021	13:31:39,229	50.038	1.501	73,61	0,94	82,11	47,32	30,94
726	06/24/2021	13:31:54,337	50.063	1.502	73,98	0,94	82,13	47,24	30,94
727	06/24/2021	13:32:09,471	50.063	1.503	73,86	0,94	82,12	47,21	30,94
728	06/24/2021	13:32:24,435	50.075	1.503	73,13	0,94	82,11	47,35	30,94
729	06/24/2021	13:32:39,493	50.038	1.501	73	0,94	82,22	47,19	30,94
730	06/24/2021	13:32:54,713	50.050	1.501	73,61	0,94	82,11	47,24	30,94
731	06/24/2021	13:33:09,522	50.063	1.502	73,38	0,94	82,08	47,31	30,94
732	06/24/2021	13:33:24,423	50.038	1.501	73,73	0,94	82,12	47,32	30,94
733	06/24/2021	13:33:39,588	50.100	1.503	73,13	0,94	82,12	47,36	30,94
734	06/24/2021	13:33:54,636	50.038	1.502	72,52	0,94	82,11	47,27	30,94
735	06/24/2021	13:34:09,629	50.050	1.501	72,64	0,94	82,11	47,27	30,94
736	06/24/2021	13:34:24,815	50.088	1.503	73,73	0,94	82,12	47,24	30,94
737	06/24/2021	13:34:39,956	50.013	1.501	72,16	0,94	82,08	47,36	30,94
738	06/24/2021	13:34:54,752	49.988	1.500	73,73	0,94	82,12	47,34	30,94
739	06/24/2021	13:35:10,021	50.063	1.502	73,25	0,94	82,07	47,41	30,94
740	06/24/2021	13:35:24,976	50.025	1.501	73,25	0,94	82,01	47,33	30,94
741	06/24/2021	13:35:40,212	50.100	1.503	72,77	0,94	82,11	47,53	30,94
742	06/24/2021	13:35:55,118	50.125	1.504	72,77	0,94	82,11	47,41	30,94
743	06/24/2021	13:36:10,139	50.038	1.502	73,86	0,94	82,12	47,38	30,94



744	06/24/2021	13:36:25,031	50.088	1.503	72,77	0,94	82,08	47,46	30,94
745	06/24/2021	13:36:40,213	50.088	1.503	72,52	0,94	82,01	47,46	30,94
746	06/24/2021	13:36:55,279	50.088	1.503	73,5	0,94	81,98	47,47	30,94
747	06/24/2021	13:37:10,478	50.075	1.502	72,64	0,94	82,11	47,55	30,94
748	06/24/2021	13:37:25,474	50.075	1.503	73,13	0,94	82,08	47,42	30,94
749	06/24/2021	13:37:40,339	50.088	1.503	72,52	0,94	82,07	47,41	30,94
750	06/24/2021	13:37:55,408	50.038	1.501	73,86	0,94	82,07	47,53	30,94
751	06/24/2021	13:38:10,433	50.038	1.501	73,61	0,94	82,12	47,55	30,94
752	06/24/2021	13:38:25,334	50.088	1.503	74,22	0,94	81,87	47,57	30,94
753	06/24/2021	13:38:40,406	50.088	1.503	73	0,94	81,87	47,47	30,94
754	06/24/2021	13:38:55,607	50.100	1.503	73,86	0,94	81,97	47,66	30,94
755	06/24/2021	13:39:10,745	50.050	1.502	73,13	0,94	81,97	47,66	30,94
756	06/24/2021	13:39:25,742	50.063	1.501	73	0,94	81,83	47,66	30,83
757	06/24/2021	13:39:40,648	50.063	1.502	72,39	0,94	81,87	47,66	30,94
758	06/24/2021	13:39:55,875	50.088	1.503	73,38	0,94	81,93	47,59	30,94
759	06/24/2021	13:40:10,877	50.088	1.502	72,64	0,94	81,93	47,57	30,83
760	06/24/2021	13:40:25,908	50.075	1.503	74,59	0,94	81,79	47,57	30,83
761	06/24/2021	13:40:40,923	50.088	1.503	74,22	0,94	81,85	47,67	30,83
762	06/24/2021	13:40:55,834	50.088	1.502	74,11	0,94	81,93	47,59	30,83
763	06/24/2021	13:41:10,939	50.038	1.501	72,52	0,94	81,82	47,53	30,83
764	06/24/2021	13:41:25,912	50.100	1.504	72,39	0,94	81,82	47,49	30,83
765	06/24/2021	13:41:41,069	50.038	1.501	73,73	0,94	81,68	47,59	30,83
766	06/24/2021	13:41:56,025	50.063	1.502	73,25	0,94	81,70	47,67	30,83
767	06/24/2021	13:42:11,022	50.050	1.501	74,22	0,94	81,78	47,62	30,83
768	06/24/2021	13:42:26,095	50.038	1.501	72,52	0,94	81,67	47,66	30,83
769	06/24/2021	13:42:41,119	50.050	1.502	72,03	0,94	81,82	47,61	30,83
770	06/24/2021	13:42:56,131	50.038	1.502	73,5	0,94	81,78	47,61	30,83
771	06/24/2021	13:43:11,418	50.038	1.501	72,88	0,94	81,71	47,62	30,83
772	06/24/2021	13:43:26,215	50.013	1.500	73,86	0,94	81,71	47,53	30,83
773	06/24/2021	13:43:41,344	50.075	1.503	72,64	0,94	81,82	47,70	30,83

774	06/24/2021	13:43:56,631	50.038	1.501	73,61	0,94	81,71	47,77	30,83
775	06/24/2021	13:44:11,479	50.025	1.502	73,61	0,94	81,82	47,66	30,83
776	06/24/2021	13:44:26,366	50.075	1.502	73,5	0,94	81,68	47,59	30,83
777	06/24/2021	13:44:41,615	50.013	1.500	71,91	0,94	81,78	47,67	30,83
778	06/24/2021	13:44:56,705	50.038	1.501	73,13	0,94	81,78	47,55	30,83
779	06/24/2021	13:45:11,742	50.000	1.501	73,86	0,94	81,71	47,52	30,83
780	06/24/2021	13:45:26,795	50.038	1.502	73,86	0,94	81,68	47,67	30,83
781	06/24/2021	13:45:41,614	50.013	1.500	73,61	0,94	81,82	47,66	30,83
782	06/24/2021	13:45:56,795	49.963	1.499	73,61	0,94	81,82	47,83	30,83
783	06/24/2021	13:46:11,801	50.050	1.502	74,22	0,94	81,82	47,85	30,83
784	06/24/2021	13:46:26,891	50.013	1.500	73,5	0,94	81,82	47,64	30,83
785	06/24/2021	13:46:41,950	50.050	1.502	74,11	0,94	81,79	47,73	30,83
786	06/24/2021	13:46:56,858	50.025	1.501	73,86	0,94	81,79	47,61	30,83
787	06/24/2021	13:47:12,105	50.013	1.500	72,88	0,94	81,78	47,76	30,83
788	06/24/2021	13:47:27,036	50.050	1.503	72,64	0,94	81,70	47,72	30,83
789	06/24/2021	13:47:42,055	50.025	1.501	72,39	0,94	81,82	47,67	30,83
790	06/24/2021	13:47:57,140	50.050	1.502	73,13	0,94	81,82	47,73	30,83
791	06/24/2021	13:48:12,205	50.013	1.500	74,47	0,94	81,79	47,63	30,83
792	06/24/2021	13:48:27,257	50.013	1.501	73,13	0,94	81,68	47,59	30,83
793	06/24/2021	13:48:42,364	50.013	1.501	73,98	0,94	81,82	47,87	30,83
794	06/24/2021	13:48:57,406	49.950	1.499	74,11	0,94	81,70	47,97	30,83
795	06/24/2021	13:49:12,237	50.013	1.501	72,52	0,94	81,82	48,03	30,83
796	06/24/2021	13:49:27,354	50.088	1.503	74,47	0,94	81,82	48,16	30,83
797	06/24/2021	13:49:42,323	50.063	1.502	73,86	0,94	81,70	48,26	30,83
798	06/24/2021	13:49:57,580	50.075	1.502	74,11	0,94	81,82	48,22	30,83
799	06/24/2021	13:50:12,364	50.013	1.501	73,38	0,94	81,82	48,23	30,83
800	06/24/2021	13:50:27,604	50.025	1.500	74,11	0,94	81,71	48,33	30,83
801	06/24/2021	13:50:42,637	50.013	1.501	73,5	0,94	81,78	48,34	30,83
802	06/24/2021	13:50:57,572	50.038	1.502	73,98	0,94	81,70	48,24	30,83
803	06/24/2021	13:51:12,818	50.063	1.502	72,77	0,94	81,68	48,24	30,83

804	06/24/2021	13:51:27,757	49.938	1.498	72,52	0,94	81,71	48,21	30,83
805	06/24/2021	13:51:42,803	50.050	1.502	73,86	0,94	81,67	48,23	30,83
806	06/24/2021	13:51:58,031	50.050	1.502	74,34	0,94	81,67	48,15	30,83
807	06/24/2021	13:52:12,911	50.013	1.501	72,77	0,94	81,56	47,93	30,83
808	06/24/2021	13:52:27,890	50.088	1.503	73,5	0,94	81,56	48,04	30,83
809	06/24/2021	13:52:42,946	50.038	1.501	74,11	0,94	81,67	47,96	30,83
810	06/24/2021	13:52:58,000	50.063	1.502	73,38	0,94	81,67	48,04	30,83
811	06/24/2021	13:53:12,884	50.025	1.501	74,22	0,94	81,67	48,07	30,83
812	06/24/2021	13:53:27,942	49.988	1.500	73,73	0,94	81,63	48,07	30,83
813	06/24/2021	13:53:43,085	50.038	1.501	72,52	0,94	81,56	47,96	30,83
814	06/24/2021	13:53:58,254	50.025	1.501	73,5	0,94	81,63	42,77	30,83
815	06/24/2021	13:54:13,162	50.075	1.502	73,73	0,94	81,63	42,79	30,83
816	06/24/2021	13:54:28,090	50.050	1.501	73,38	0,94	81,63	42,59	30,83
817	06/24/2021	13:54:43,162	50.013	1.500	73,5	0,94	81,63	42,79	30,83
818	06/24/2021	13:54:58,141	50.063	1.502	73,5	0,94	81,63	42,73	30,83
819	06/24/2021	13:55:13,318	50.000	1.500	73,38	0,94	81,63	42,79	30,83
820	06/24/2021	13:55:28,610	50.013	1.501	73,86	0,94	81,67	42,99	30,83
821	06/24/2021	13:55:43,544	50.025	1.501	72,77	0,94	81,63	42,94	30,83
822	06/24/2021	13:55:58,342	50.038	1.501	72,77	0,94	81,63	42,65	30,83
823	06/24/2021	13:56:13,306	50.063	1.502	73,61	0,94	81,52	42,79	30,83
824	06/24/2021	13:56:28,525	49.988	1.500	74,59	0,94	81,65	42,66	30,83
825	06/24/2021	13:56:43,574	50.000	1.500	74,22	0,94	81,63	42,98	30,83
826	06/24/2021	13:56:58,846	50.050	1.501	73,25	0,94	81,56	42,81	30,83
827	06/24/2021	13:57:13,582	50.000	1.500	73,86	0,94	81,65	42,98	30,83
828	06/24/2021	13:57:28,745	50.063	1.502	72,77	0,94	81,56	42,79	30,83
829	06/24/2021	13:57:43,631	50.013	1.500	74,11	0,94	81,52	42,99	30,83
830	06/24/2021	13:57:58,895	50.025	1.501	73,25	0,94	81,67	42,82	30,83
831	06/24/2021	13:58:13,908	50.013	1.501	73,98	0,94	81,52	42,97	30,83
832	06/24/2021	13:58:29,015	49.988	1.499	73	0,94	81,63	43,04	30,83
833	06/24/2021	13:58:44,040	50.050	1.502	74,11	0,94	81,52	42,94	30,83

834	06/24/2021	13:58:59,169	50.075	1.502	73,38	0,94	81,54	42,87	30,83
835	06/24/2021	13:59:14,013	50.088	1.503	73,98	0,94	81,56	43,06	30,83
836	06/24/2021	13:59:29,184	50.050	1.502	73,38	0,94	81,42	42,92	30,83
837	06/24/2021	13:59:44,213	50.025	1.501	72,77	0,94	81,52	42,83	30,83
838	06/24/2021	13:59:59,199	50.050	1.502	73,61	0,94	81,53	42,92	30,83
839	06/24/2021	14:00:14,314	50.050	1.502	73,86	0,94	81,53	43,13	30,83
840	06/24/2021	14:00:29,088	49.988	1.500	73,98	0,94	81,42	43,16	30,83
841	06/24/2021	14:00:44,361	50.025	1.501	74,34	0,94	81,41	42,86	30,83
842	06/24/2021	14:00:59,268	50.063	1.502	73	0,94	81,41	43,16	30,83
843	06/24/2021	14:01:14,313	50.025	1.500	73,38	0,94	81,52	43,14	30,83
844	06/24/2021	14:01:29,317	50.100	1.503	74,83	0,94	81,54	42,98	30,83
845	06/24/2021	14:01:44,481	50.000	1.500	73,25	0,94	81,52	43,15	30,83
846	06/24/2021	14:01:59,547	50.050	1.501	73,73	0,94	81,52	43,16	30,83
847	06/24/2021	14:02:14,621	50.013	1.500	73,86	0,94	81,53	43,32	30,83
848	06/24/2021	14:02:29,742	50.013	1.501	74,34	0,94	81,56	43,22	30,83
849	06/24/2021	14:02:44,648	50.013	1.501	74,34	0,94	81,41	43,24	30,83
850	06/24/2021	14:02:59,638	50.025	1.500	74,22	0,94	81,52	43,04	30,83
851	06/24/2021	14:03:14,634	50.038	1.502	74,34	0,94	81,54	43,12	30,83
852	06/24/2021	14:03:29,653	50.088	1.502	74,34	0,94	81,52	43,21	30,83
853	06/24/2021	14:03:44,962	49.988	1.500	73,86	0,94	81,54	43,31	30,83
854	06/24/2021	14:03:59,891	50.038	1.501	73	0,94	81,54	43,26	30,83
855	06/24/2021	14:04:15,110	50.038	1.502	73,61	0,94	81,53	43,01	30,83
856	06/24/2021	14:04:29,979	50.050	1.501	73,86	0,94	81,51	42,99	30,83
857	06/24/2021	14:04:45,075	50.013	1.500	73,61	0,94	81,51	43,16	30,83
858	06/24/2021	14:04:59,938	50.000	1.500	74,22	0,94	81,49	43,36	30,83
859	06/24/2021	14:05:14,857	50.013	1.500	73,13	0,94	81,53	42,95	30,83
860	06/24/2021	14:05:30,171	50.063	1.503	72,88	0,94	81,49	43,13	30,83
861	06/24/2021	14:05:45,102	50.050	1.502	73,38	0,94	81,52	43,32	30,83
862	06/24/2021	14:06:00,244	50.063	1.502	72,88	0,94	81,39	43,15	30,83
863	06/24/2021	14:06:15,111	50.075	1.502	73,98	0,94	81,52	43,18	30,83

864	06/24/2021	14:06:30,330	50.025	1.501	74,47	0,94	81,49	43,23	30,83
865	06/24/2021	14:06:45,142	50.050	1.501	73,38	0,94	81,52	43,21	30,83
866	06/24/2021	14:07:00,363	50.075	1.503	73	0,94	81,52	43,23	30,83
867	06/24/2021	14:07:15,540	50.000	1.500	73,5	0,94	81,63	43,21	30,83
868	06/24/2021	14:07:30,567	49.988	1.499	73,25	0,94	81,39	43,27	30,83
869	06/24/2021	14:07:45,619	49.938	1.499	72,88	0,94	81,51	43,38	30,83
870	06/24/2021	14:08:00,576	49.963	1.499	72,52	0,94	81,52	43,38	30,83
871	06/24/2021	14:08:15,665	49.963	1.499	72,52	0,94	81,49	43,21	30,83
872	06/24/2021	14:08:30,593	50.025	1.501	73,61	0,94	81,52	43,29	30,83
873	06/24/2021	14:08:45,803	50.013	1.500	73	0,94	81,52	43,17	30,83
874	06/24/2021	14:09:00,657	49.963	1.499	73,98	0,94	81,39	43,21	30,83
875	06/24/2021	14:09:15,722	49.938	1.499	74,22	0,94	81,52	43,24	30,83
876	06/24/2021	14:09:30,924	49.950	1.499	73	0,94	81,52	43,19	30,83
877	06/24/2021	14:09:46,030	49.988	1.500	73,98	0,94	81,52	43,17	30,83
878	06/24/2021	14:10:00,983	49.988	1.500	74,22	0,94	81,49	43,14	30,83
879	06/24/2021	14:10:15,950	49.975	1.499	73,38	0,94	81,52	43,41	30,83
880	06/24/2021	14:10:31,119	49.950	1.499	74,34	0,94	81,49	43,13	30,83
881	06/24/2021	14:10:45,991	49.950	1.500	73,61	0,94	81,52	43,46	30,83
882	06/24/2021	14:11:00,995	49.938	1.498	74,34	0,94	81,52	43,49	30,83
883	06/24/2021	14:11:16,217	49.988	1.500	73,98	0,94	81,52	43,52	30,83
884	06/24/2021	14:11:31,206	49.963	1.499	74,34	0,94	81,52	43,36	30,83
885	06/24/2021	14:11:46,265	49.925	1.499	73,98	0,94	81,28	43,46	30,72
886	06/24/2021	14:12:01,413	49.938	1.499	74,11	0,94	81,36	43,46	30,83
887	06/24/2021	14:12:16,362	49.925	1.498	72,03	0,94	81,37	43,16	30,72
888	06/24/2021	14:12:31,352	49.913	1.497	73,86	0,94	81,41	43,44	30,83
889	06/24/2021	14:12:46,343	49.925	1.498	72,88	0,94	81,48	43,21	30,72

H.2 REGISTRO DE MEDICIONES DEL MOTOR DE LA UNIDAD 2

Promedio			50,04	1.501,35	56,57	0,95	84,78	48,17
Item	Date	Time	Frequency (Hz)	Engine Speed (rpm)	Oil Pressure (psi)	FP	Coolant Temperature (°C)	Aftercooler Temperature (°C)
1	24-06-2021	10:30:08,793	50,075	1502,6	57,56	0,95	84,10	43,73
2	24-06-2021	10:30:23,858	50,05	1501,8	58,17	0,95	84,19	43,72
3	24-06-2021	10:30:39,039	50,113	1503,9	56,47	0,95	84,20	43,88
4	24-06-2021	10:30:53,916	50,063	1502,3	58,17	0,95	84,19	44,01
5	24-06-2021	10:31:09,001	50,063	1501,8	58,3	0,95	84,06	43,91
6	24-06-2021	10:31:24,207	50,075	1502,4	56,72	0,95	84,09	43,86
7	24-06-2021	10:31:39,165	50,025	1500,6	56,22	0,95	84,06	43,97
8	24-06-2021	10:31:54,401	50,05	1501,6	54,89	0,95	84,27	43,89
9	24-06-2021	10:32:09,255	50,05	1501,5	58,06	0,95	84,20	43,95
10	24-06-2021	10:32:24,196	50,075	1502,3	58,55	0,95	84,19	44,01
11	24-06-2021	10:32:39,423	50,05	1501,6	58,42	0,95	84,32	43,97
12	24-06-2021	10:32:54,307	50,013	1500,4	56,95	0,95	84,24	44,01
13	24-06-2021	10:33:09,565	50,05	1502	56,72	0,95	84,20	43,82
14	24-06-2021	10:33:24,400	50,075	1502,6	57,81	0,95	84,20	43,80
15	24-06-2021	10:33:39,685	50,025	1501,5	58,55	0,95	84,29	43,82
16	24-06-2021	10:33:54,773	50,05	1501,6	56,72	0,95	84,20	43,99
17	24-06-2021	10:34:09,693	50,063	1501,8	57,56	0,95	84,33	44,17
18	24-06-2021	10:34:24,636	50,05	1502,1	57,33	0,95	84,29	44,18
19	24-06-2021	10:34:39,840	50,038	1501,6	57,33	0,95	84,28	43,94
20	24-06-2021	10:34:54,838	50,025	1500,9	58,55	0,95	84,23	44,01
21	24-06-2021	10:35:09,964	49,975	1499,9	57,08	0,95	84,32	44,02
22	24-06-2021	10:35:24,915	50,05	1501,8	57,2	0,95	84,29	44,12
23	24-06-2021	10:35:40,080	50,075	1501,9	56,11	0,95	84,33	44,26
24	24-06-2021	10:35:55,262	50,05	1501,3	58,17	0,95	84,24	44,04
25	24-06-2021	10:36:10,268	50,088	1502,1	57,33	0,95	84,35	44,17

26	24-06-2021	10:36:25,334	50,063	1501,5	56,22	0,95	84,11	44,06
27	24-06-2021	10:36:40,240	50,05	1501,9	57,2	0,95	84,32	44,08
28	24-06-2021	10:36:55,231	49,988	1499,6	57,2	0,95	84,24	44,20
29	24-06-2021	10:37:10,424	50,038	1501,6	56,11	0,95	84,35	44,19
30	24-06-2021	10:37:25,325	50,113	1502,8	57,81	0,95	84,32	44,23
31	24-06-2021	10:37:40,371	50,088	1502,6	57,81	0,95	84,20	44,06
32	24-06-2021	10:37:55,740	50,05	1501,8	58,3	0,95	84,20	44,19
33	24-06-2021	10:38:10,591	50,05	1502	57,45	0,95	84,20	44,27
34	24-06-2021	10:38:25,727	50,038	1501,3	57,81	0,95	84,10	44,36
35	24-06-2021	10:38:40,664	50,125	1503,9	56,34	0,95	84,32	44,34
36	24-06-2021	10:38:55,773	50,1	1502,9	58,06	0,95	84,24	44,44
37	24-06-2021	10:39:10,998	50,075	1502,5	57,2	0,95	84,34	44,39
38	24-06-2021	10:39:25,724	50,063	1502	56,34	0,95	84,32	44,59
39	24-06-2021	10:39:40,820	50,038	1501,1	57,69	0,95	84,24	44,58
40	24-06-2021	10:39:56,039	50,038	1501,3	56,11	0,95	84,32	44,64
41	24-06-2021	10:40:11,098	50,038	1501,6	57,69	0,95	84,34	44,57
42	24-06-2021	10:40:26,129	50,063	1501,9	58,17	0,95	84,32	44,36
43	24-06-2021	10:40:40,974	50,038	1501,4	57,81	0,95	84,33	44,49
44	24-06-2021	10:40:56,255	50,025	1501,6	56,11	0,95	84,24	44,48
45	24-06-2021	10:41:11,233	50,1	1503,1	56,95	0,95	84,20	44,53
46	24-06-2021	10:41:26,137	50,038	1501	57,33	0,95	84,24	44,64
47	24-06-2021	10:41:41,305	50,038	1501,5	57,33	0,95	84,34	44,49
48	24-06-2021	10:41:56,367	50,038	1501,1	57,33	0,95	84,35	44,66
49	24-06-2021	10:42:11,356	50,025	1500,9	55,61	0,95	84,23	44,61
50	24-06-2021	10:42:26,482	50,1	1502,8	58,17	0,95	84,24	44,76
51	24-06-2021	10:42:41,579	50,113	1503,5	56,59	0,95	84,35	44,82
52	24-06-2021	10:42:56,585	50,063	1502,4	57,2	0,95	84,20	44,72
53	24-06-2021	10:43:11,506	50,038	1501,9	56,95	0,95	84,35	44,77
54	24-06-2021	10:43:26,484	50,075	1502,1	57,69	0,95	84,35	44,82
55	24-06-2021	10:43:41,671	50,025	1500,8	55,5	0,95	84,32	44,83

56	24-06-2021	10:43:56,739	50,05	1502	57,69	0,95	84,23	44,69
57	24-06-2021	10:44:11,665	50,1	1503,4	58,06	0,95	84,34	44,63
58	24-06-2021	10:44:26,819	50,063	1502,5	56,47	0,95	84,24	44,63
59	24-06-2021	10:44:41,956	50,188	1505,6	58,06	0,95	84,35	44,53
60	24-06-2021	10:44:57,032	50,088	1502,8	55,73	0,95	84,35	44,68
61	24-06-2021	10:45:12,142	50,125	1503,9	58,06	0,95	84,21	44,83
62	24-06-2021	10:45:27,055	50,088	1503	55,61	0,95	84,32	45,00
63	24-06-2021	10:45:42,184	50,025	1500,5	57,56	0,95	84,35	44,96
64	24-06-2021	10:45:57,044	50,125	1503,9	57,56	0,95	84,32	45,11
65	24-06-2021	10:46:12,293	50,113	1503,4	57,69	0,95	84,24	45,03
66	24-06-2021	10:46:27,208	50,075	1502,1	58,3	0,95	84,35	45,06
67	24-06-2021	10:46:42,266	50,113	1503,8	57,33	0,95	84,27	45,20
68	24-06-2021	10:46:57,370	50,1	1503	58,8	0,95	84,44	45,18
69	24-06-2021	10:47:12,290	50,088	1502,9	56,95	0,95	84,36	45,06
70	24-06-2021	10:47:27,324	50,038	1501,4	57,33	0,95	84,24	45,09
71	24-06-2021	10:47:42,347	50,075	1502,4	56,22	0,95	84,24	45,15
72	24-06-2021	10:47:57,376	50,063	1502,8	56,72	0,95	84,46	45,12
73	24-06-2021	10:48:12,428	50,1	1503,1	57,33	0,95	84,38	45,25
74	24-06-2021	10:48:27,529	50,088	1502,9	57,81	0,95	84,46	45,25
75	24-06-2021	10:48:42,744	50,075	1502,4	58,3	0,95	84,35	45,23
76	24-06-2021	10:48:57,655	50,038	1501,5	56,95	0,95	84,46	45,20
77	24-06-2021	10:49:12,797	50,038	1501,3	56,95	0,95	84,36	45,08
78	24-06-2021	10:49:27,903	50,063	1502	56,95	0,95	84,28	45,17
79	24-06-2021	10:49:42,898	50,013	1500,6	57,33	0,95	84,35	45,21
80	24-06-2021	10:49:58,014	50,063	1501,8	55,38	0,95	84,35	45,21
81	24-06-2021	10:50:12,795	50,013	1500,6	57,2	0,95	84,39	45,21
82	24-06-2021	10:50:27,840	50,05	1501,8	56,95	0,95	84,36	45,07
83	24-06-2021	10:50:42,985	50,013	1499,4	56,59	0,95	84,46	45,25
84	24-06-2021	10:50:57,939	50,05	1501,5	55,38	0,95	84,46	45,27
85	24-06-2021	10:51:13,236	50,05	1501,5	55,61	0,95	84,49	45,27



86	24-06-2021	10:51:28,207	50,025	1500,9	56,72	0,95	84,35	45,31
87	24-06-2021	10:51:43,304	50,025	1500,8	56,84	0,95	84,49	45,35
88	24-06-2021	10:51:58,227	50,038	1501,4	55,98	0,95	84,44	45,21
89	24-06-2021	10:52:13,161	49,988	1499,6	57,2	0,95	84,46	45,31
90	24-06-2021	10:52:28,434	50,025	1501	57,33	0,95	84,36	45,33
91	24-06-2021	10:52:43,413	50,025	1500,6	57,56	0,95	84,49	45,29
92	24-06-2021	10:52:58,406	50,025	1500,8	58,67	0,95	84,38	45,29
93	24-06-2021	10:53:13,397	50	1500,4	57,45	0,95	84,38	45,31
94	24-06-2021	10:53:28,544	50	1500,8	56,72	0,95	84,38	45,24
95	24-06-2021	10:53:43,529	50,05	1501,9	56,72	0,95	84,36	45,25
96	24-06-2021	10:53:58,643	50,013	1500,3	56,95	0,95	84,35	45,41
97	24-06-2021	10:54:13,609	50,05	1501,8	56,72	0,95	84,36	45,26
98	24-06-2021	10:54:28,847	50,05	1501,8	55,73	0,95	84,46	45,24
99	24-06-2021	10:54:43,722	50,038	1501,4	57,33	0,95	84,46	45,22
100	24-06-2021	10:54:58,733	50,013	1500,4	57,08	0,95	84,35	45,51
101	24-06-2021	10:55:13,702	50,025	1501,1	57,33	0,95	84,46	45,52
102	24-06-2021	10:55:29,017	50,063	1501,9	57,45	0,95	84,49	45,54
103	24-06-2021	10:55:43,899	50,025	1500,9	56,11	0,95	84,49	45,72
104	24-06-2021	10:55:59,022	50	1499,9	57,56	0,95	84,49	45,65
105	24-06-2021	10:56:14,071	49,975	1499,3	57,81	0,95	84,39	45,57
106	24-06-2021	10:56:28,969	50,063	1502,1	56,84	0,95	84,39	45,64
107	24-06-2021	10:56:44,035	50	1500,1	57,08	0,95	84,49	45,64
108	24-06-2021	10:56:59,193	50,05	1501,8	57,2	0,95	84,36	45,47
109	24-06-2021	10:57:14,183	49,975	1499,4	55	0,95	84,46	45,47
110	24-06-2021	10:57:29,220	50,05	1501,5	56,59	0,95	84,49	45,54
111	24-06-2021	10:57:44,232	50,088	1502,8	56,47	0,95	84,49	45,48
112	24-06-2021	10:57:59,248	50,05	1501,5	58,42	0,95	84,46	45,41
113	24-06-2021	10:58:14,346	50,075	1502,4	55,73	0,95	84,36	45,57
114	24-06-2021	10:58:29,659	50,063	1501,8	57,33	0,95	84,35	45,46
115	24-06-2021	10:58:44,406	50,05	1502,1	57,69	0,95	84,46	45,59

116	24-06-2021	10:58:59,552	50,05	1501,6	55,25	0,95	84,46	45,63
117	24-06-2021	10:59:14,578	50,1	1503,1	56,34	0,95	84,38	45,65
118	24-06-2021	10:59:29,559	50,075	1502,5	58,55	0,95	84,36	45,54
119	24-06-2021	10:59:44,578	50,1	1503,4	57,2	0,95	84,36	45,65
120	24-06-2021	10:59:59,846	50,038	1500,9	57,45	0,95	84,36	45,58
121	24-06-2021	11:00:14,868	50,075	1502,6	57,33	0,95	84,46	45,73
122	24-06-2021	11:00:29,728	50,113	1503,1	57,94	0,95	84,46	45,74
123	24-06-2021	11:00:45,071	50,05	1501,5	58,42	0,95	84,49	45,71
124	24-06-2021	11:00:59,894	50,063	1501,8	58,06	0,95	84,46	45,77
125	24-06-2021	11:01:15,004	50,05	1502	55,73	0,95	84,49	45,86
126	24-06-2021	11:01:30,168	50,088	1502,4	56,34	0,95	84,49	45,81
127	24-06-2021	11:01:45,210	50,075	1502,3	57,69	0,95	84,49	45,82
128	24-06-2021	11:02:00,269	49,988	1499,9	57,81	0,95	84,46	45,89
129	24-06-2021	11:02:15,087	49,975	1499,8	56,11	0,95	84,60	45,91
130	24-06-2021	11:02:30,330	50,038	1501,9	56,59	0,95	84,49	45,89
131	24-06-2021	11:02:45,183	50,013	1500,5	57,69	0,95	84,60	46,14
132	24-06-2021	11:03:00,406	50,013	1500	56,34	0,95	84,63	46,11
133	24-06-2021	11:03:15,290	50,063	1501,6	56,84	0,95	84,53	46,10
134	24-06-2021	11:03:30,495	50,013	1500,6	56,47	0,95	84,49	46,25
135	24-06-2021	11:03:45,357	50,025	1500,9	55,61	0,95	84,61	46,26
136	24-06-2021	11:04:00,369	49,975	1499,4	56,11	0,95	84,61	46,33
137	24-06-2021	11:04:15,561	50,088	1501,8	57,69	0,95	84,51	46,28
138	24-06-2021	11:04:30,599	50,038	1500,6	57,33	0,95	84,60	46,38
139	24-06-2021	11:04:45,577	50,063	1502,1	57,45	0,95	84,64	46,46
140	24-06-2021	11:05:00,920	50,038	1501,8	57,69	0,95	84,64	46,37
141	24-06-2021	11:05:15,778	49,975	1499,4	57,33	0,95	84,61	46,38
142	24-06-2021	11:05:30,953	50,075	1502,4	57,81	0,95	84,51	46,38
143	24-06-2021	11:05:46,030	50,075	1502,8	55,73	0,95	84,64	46,36
144	24-06-2021	11:06:01,020	50,05	1501,9	55,5	0,95	84,63	46,56
145	24-06-2021	11:06:16,215	50,05	1502	57,08	0,95	84,63	46,49

146	24-06-2021	11:06:31,097	50,013	1499,9	57,81	0,95	84,62	46,61
147	24-06-2021	11:06:46,241	50,088	1502,6	56,22	0,95	84,63	46,56
148	24-06-2021	11:07:01,085	50,025	1500,5	55,86	0,95	84,63	46,48
149	24-06-2021	11:07:16,184	50,063	1502,3	56,59	0,95	84,51	46,46
150	24-06-2021	11:07:31,462	50,063	1502,3	56,34	0,95	84,49	46,65
151	24-06-2021	11:07:46,442	49,988	1499,3	55,5	0,95	84,51	46,56
152	24-06-2021	11:08:01,293	50,088	1502,3	57,81	0,95	84,61	46,65
153	24-06-2021	11:08:16,345	50,1	1503,5	55,86	0,95	84,63	46,63
154	24-06-2021	11:08:31,703	50,088	1502,4	56,59	0,95	84,63	46,65
155	24-06-2021	11:08:46,697	50,05	1501,6	56,11	0,95	84,64	46,66
156	24-06-2021	11:09:01,688	50,013	1500,8	56,11	0,95	84,63	46,65
157	24-06-2021	11:09:16,634	50,113	1503,5	58,42	0,95	84,51	46,72
158	24-06-2021	11:09:31,634	50,125	1503,3	57,81	0,95	84,53	46,57
159	24-06-2021	11:09:46,756	50,075	1502,3	56,95	0,95	84,53	46,76
160	24-06-2021	11:10:01,747	50,125	1504	57,33	0,95	84,54	46,76
161	24-06-2021	11:10:16,865	50,113	1503,3	56,34	0,95	84,53	46,72
162	24-06-2021	11:10:32,073	50,175	1506	56,72	0,95	84,61	46,72
163	24-06-2021	11:10:46,977	50,138	1503,6	57,56	0,95	84,63	46,63
164	24-06-2021	11:11:01,954	50,163	1505,4	58,06	0,95	84,64	46,82
165	24-06-2021	11:11:17,033	50,15	1504,9	56,11	0,95	84,54	46,74
166	24-06-2021	11:11:32,231	50,075	1502,6	55,73	0,95	84,51	46,88
167	24-06-2021	11:11:47,249	50,1	1503,1	57,45	0,95	84,60	46,63
168	24-06-2021	11:12:02,512	50,163	1504,9	57,08	0,95	84,53	46,76
169	24-06-2021	11:12:17,356	50,088	1503	57,69	0,95	84,61	46,50
170	24-06-2021	11:12:32,231	50,113	1502,6	58,06	0,95	84,62	46,74
171	24-06-2021	11:12:47,240	50,1	1502,6	55,98	0,95	84,49	46,62
172	24-06-2021	11:13:02,566	50,138	1504,1	56,59	0,95	84,53	46,74
173	24-06-2021	11:13:17,772	50,113	1503,5	56,95	0,95	84,61	46,76
174	24-06-2021	11:13:32,534	50,113	1503,4	57,2	0,95	84,64	46,76
175	24-06-2021	11:13:47,815	50,138	1503,8	57,69	0,95	84,51	46,73

176	24-06-2021	11:14:02,771	50,088	1503	57,69	0,95	84,58	46,74
177	24-06-2021	11:14:17,777	50,113	1503,6	56,59	0,95	84,49	46,74
178	24-06-2021	11:14:32,743	50,15	1505,3	57,94	0,95	84,53	46,71
179	24-06-2021	11:14:47,874	50,138	1504,1	57,56	0,95	84,60	46,74
180	24-06-2021	11:15:02,979	50,125	1504	57,45	0,95	84,51	46,74
181	24-06-2021	11:15:17,763	50,088	1502,8	57,56	0,95	84,53	46,76
182	24-06-2021	11:15:32,943	50,1	1503,4	56,47	0,95	84,51	46,73
183	24-06-2021	11:15:48,027	50,125	1503,9	55,73	0,95	84,60	46,78
184	24-06-2021	11:16:03,174	50,1	1503,3	58,17	0,95	84,49	46,59
185	24-06-2021	11:16:17,923	50,1	1503	57,45	0,95	84,53	46,62
186	24-06-2021	11:16:33,207	50,113	1503,3	58,17	0,95	84,51	46,74
187	24-06-2021	11:16:48,106	50,113	1503,6	58,42	0,95	84,63	46,93
188	24-06-2021	11:17:03,181	50,125	1504,3	56,47	0,95	84,63	46,85
189	24-06-2021	11:17:18,402	50,125	1503,8	55,61	0,95	84,63	46,69
190	24-06-2021	11:17:33,399	50,138	1504,1	56,84	0,95	84,51	46,76
191	24-06-2021	11:17:48,441	50,138	1504,3	56,34	0,95	84,54	46,71
192	24-06-2021	11:18:03,542	50,088	1503	57,56	0,95	84,51	46,72
193	24-06-2021	11:18:18,523	50,15	1505	55,38	0,95	84,53	46,84
194	24-06-2021	11:18:33,562	50,125	1504,4	56,11	0,95	84,63	46,84
195	24-06-2021	11:18:48,557	50,175	1505,6	56,11	0,95	84,49	46,68
196	24-06-2021	11:19:03,586	50,188	1505,8	58,3	0,95	84,49	46,82
197	24-06-2021	11:19:18,627	50,113	1503,8	56,22	0,95	84,51	46,88
198	24-06-2021	11:19:33,781	50,125	1504,3	56,34	0,95	84,51	46,89
199	24-06-2021	11:19:48,691	50,1	1503,8	56,95	0,95	84,61	46,96
200	24-06-2021	11:20:03,734	50,15	1505,3	57,08	0,95	84,60	47,05
201	24-06-2021	11:20:18,797	50,138	1504,4	56,72	0,95	84,64	47,02
202	24-06-2021	11:20:33,878	50,1	1503	55,25	0,95	84,63	46,88
203	24-06-2021	11:20:49,041	50,138	1504,5	56,59	0,95	84,63	47,09
204	24-06-2021	11:21:03,952	50,163	1505,1	55,5	0,95	84,64	47,19
205	24-06-2021	11:21:34,073	50,125	1503,9	56,47	0,95	84,64	47,11

206	24-06-2021	11:21:34,073	50,125	1503,9	56,47	0,95	84,64	47,11
207	24-06-2021	11:21:49,518	50,125	1504,3	58,17	0,95	84,64	47,16
208	24-06-2021	11:22:04,640	50,1	1503,1	56,47	0,95	84,63	47,17
209	24-06-2021	11:22:19,647	50,113	1503,5	58,17	0,95	84,66	47,16
210	24-06-2021	11:22:34,717	50,163	1505,1	56,47	0,95	84,64	47,23
211	24-06-2021	11:22:49,629	50,125	1504,5	57,08	0,95	84,63	47,10
212	24-06-2021	11:23:04,560	50,075	1502,8	57,2	0,95	84,64	47,17
213	24-06-2021	11:23:19,574	50,125	1503,6	57,45	0,95	84,64	47,19
214	24-06-2021	11:23:34,836	50,1	1503,6	57,33	0,95	84,64	47,26
215	24-06-2021	11:23:49,763	50,138	1503,9	56,72	0,95	84,64	47,16
216	24-06-2021	11:24:04,712	50,088	1502	56,72	0,95	84,62	47,02
217	24-06-2021	11:24:20,114	50,163	1504,6	57,56	0,95	84,63	47,16
218	24-06-2021	11:24:35,034	50,138	1504,5	57,2	0,95	84,64	47,12
219	24-06-2021	11:24:50,047	50,15	1505	56,22	0,95	84,54	47,19
220	24-06-2021	11:25:05,067	50,175	1505,5	56,59	0,95	84,64	47,16
221	24-06-2021	11:25:20,265	50,138	1504,5	57,08	0,95	84,53	47,24
222	24-06-2021	11:25:35,348	50,113	1504	57,56	0,95	84,63	47,33
223	24-06-2021	11:25:50,358	50,075	1502,1	57,45	0,95	84,64	47,24
224	24-06-2021	11:26:05,233	50,125	1503,8	56,72	0,95	84,64	47,17
225	24-06-2021	11:26:20,248	50,163	1504,5	56,22	0,95	84,63	47,24
226	24-06-2021	11:26:35,442	50,113	1504	55,86	0,95	84,54	47,24
227	24-06-2021	11:26:50,573	50,063	1501,5	57,94	0,95	84,64	47,33
228	24-06-2021	11:27:05,337	50,063	1502,1	56,11	0,95	84,53	47,32
229	24-06-2021	11:27:20,394	50,063	1501,8	56,95	0,95	84,62	47,24
230	24-06-2021	11:27:35,456	50,175	1505,5	56,11	0,95	84,63	47,21
231	24-06-2021	11:27:50,729	50,038	1501	55,61	0,95	84,63	47,35
232	24-06-2021	11:28:05,740	50,075	1502,4	56,72	0,95	84,76	47,19
233	24-06-2021	11:28:20,801	50,125	1504	58,06	0,95	84,53	47,24
234	24-06-2021	11:28:36,173	50,125	1503,6	57,69	0,95	84,62	47,31
235	24-06-2021	11:28:51,038	50,05	1501,6	56,34	0,95	84,64	47,32

236	24-06-2021	11:29:06,038	50,113	1503,5	55,73	0,95	84,64	47,36
237	24-06-2021	11:29:21,314	50,063	1501,8	56,95	0,95	84,64	47,27
238	24-06-2021	11:29:36,232	50,063	1502,3	57,56	0,95	84,64	47,27
239	24-06-2021	11:29:51,252	50,15	1504,6	55,25	0,95	84,66	47,24
240	24-06-2021	11:30:06,213	50,088	1502,6	56,59	0,95	84,63	47,36
241	24-06-2021	11:30:21,324	50,075	1501,5	56,47	0,95	84,64	47,34
242	24-06-2021	11:30:36,361	50,088	1502,5	55,86	0,95	84,68	47,41
243	24-06-2021	11:30:51,544	50,088	1502,8	57,33	0,95	84,64	47,33
244	24-06-2021	11:31:06,628	50,025	1501,3	55,5	0,95	84,76	47,53
245	24-06-2021	11:31:21,630	50,075	1501,9	56,95	0,95	84,64	47,41
246	24-06-2021	11:31:36,587	50,025	1501,4	56,59	0,95	84,64	47,38
247	24-06-2021	11:31:51,779	50,1	1503,1	57,45	0,95	84,68	47,46
248	24-06-2021	11:32:06,677	50,038	1501,6	55,98	0,95	84,64	47,46
249	24-06-2021	11:32:21,731	50,063	1501,9	56,84	0,95	84,68	47,47
250	24-06-2021	11:32:36,792	50,05	1501,9	56,72	0,95	84,68	47,55
251	24-06-2021	11:32:51,654	50,025	1501,6	56,59	0,95	84,66	47,42
252	24-06-2021	11:33:06,806	50,05	1502,1	57,08	0,95	84,68	47,41
253	24-06-2021	11:33:22,013	50,1	1503,3	56,72	0,95	84,64	47,53
254	24-06-2021	11:33:36,881	50,038	1501,5	56,59	0,95	84,76	47,55
255	24-06-2021	11:33:52,016	50,1	1503,3	56,11	0,95	84,76	47,57
256	24-06-2021	11:34:06,978	50,075	1502,6	55,5	0,95	84,64	47,47
257	24-06-2021	11:34:22,206	50,088	1502,3	57,56	0,95	84,66	47,66
258	24-06-2021	11:34:37,319	50,088	1502,9	57,33	0,95	84,79	47,66
259	24-06-2021	11:34:52,242	50,05	1501,6	55,86	0,95	84,64	47,66
260	24-06-2021	11:35:07,163	50,05	1501,6	55,73	0,95	84,79	47,66
261	24-06-2021	11:35:22,249	50,025	1501,6	57,94	0,95	84,68	47,59
262	24-06-2021	11:35:37,362	50,113	1503,6	57,2	0,95	84,66	47,57
263	24-06-2021	11:35:52,470	50,163	1505,4	57,69	0,95	84,64	47,57
264	24-06-2021	11:36:07,576	50,063	1501,6	56,84	0,95	84,79	47,67
265	24-06-2021	11:36:22,562	50,038	1501,8	56,72	0,95	84,79	47,59

266	24-06-2021	11:36:37,639	50,038	1501,5	56,95	0,95	84,68	47,53
267	24-06-2021	11:36:52,717	50,063	1502,1	56,47	0,95	84,69	47,49
268	24-06-2021	11:37:07,718	50,075	1502	56,72	0,95	84,66	47,59
269	24-06-2021	11:37:22,714	50,038	1501	56,59	0,95	84,69	47,67
270	24-06-2021	11:37:37,723	50,075	1502,3	57,56	0,95	84,79	47,62
271	24-06-2021	11:37:53,012	50,075	1502,3	56,47	0,95	84,77	47,66
272	24-06-2021	11:38:07,955	50,013	1500,5	55,38	0,95	84,79	47,61
273	24-06-2021	11:38:23,148	50,125	1504,3	56,34	0,95	84,64	47,61
274	24-06-2021	11:38:38,159	50,075	1502,3	56,11	0,95	84,66	47,62
275	24-06-2021	11:38:53,029	50,1	1503,1	55,86	0,95	84,79	47,53
276	24-06-2021	11:39:08,105	50,075	1502,5	57,81	0,95	84,64	47,70
277	24-06-2021	11:39:23,365	50,063	1502,5	56,72	0,95	84,66	47,77
278	24-06-2021	11:39:38,328	50,125	1503,6	57,56	0,95	84,76	47,66
279	24-06-2021	11:39:53,347	50,013	1500,9	55,73	0,95	84,79	47,59
280	24-06-2021	11:40:08,204	50,05	1501,8	57,08	0,95	84,79	47,67
281	24-06-2021	11:40:23,459	50,063	1502	55,13	0,95	84,68	47,55
282	24-06-2021	11:40:38,534	50,025	1501	55,86	0,95	84,76	47,52
283	24-06-2021	11:40:53,308	50,013	1500,6	55,13	0,95	84,80	47,67
284	24-06-2021	11:41:08,543	50,063	1502,1	57,69	0,95	84,64	47,66
285	24-06-2021	11:41:23,621	50,038	1501,8	57,08	0,95	84,68	47,83
286	24-06-2021	11:41:38,672	50,013	1500,6	55,73	0,95	84,64	47,85
287	24-06-2021	11:41:53,847	49,975	1500,1	57,45	0,95	84,79	47,64
288	24-06-2021	11:42:08,791	49,875	1496,6	55,86	0,95	84,66	47,73
289	24-06-2021	11:42:23,827	49,963	1498,8	57,2	0,95	84,79	47,61
290	24-06-2021	11:42:39,181	49,963	1499	56,34	0,95	84,66	47,76
291	24-06-2021	11:42:54,005	49,913	1497,6	56,84	0,95	84,80	47,72
292	24-06-2021	11:43:08,872	49,875	1496,6	57,2	0,95	84,80	47,67
293	24-06-2021	11:43:24,039	49,95	1498,5	56,22	0,95	84,69	47,73
294	24-06-2021	11:43:38,963	49,85	1495,6	56,11	0,95	84,79	47,63
295	24-06-2021	11:43:54,107	49,95	1498,5	55	0,95	84,77	47,59

296	24-06-2021	11:44:09,194	49,9	1497,1	55,98	0,95	84,77	47,87
297	24-06-2021	11:44:24,197	49,888	1496,9	56,72	0,95	84,79	47,97
298	24-06-2021	11:44:39,359	49,925	1498	56,34	0,95	84,80	48,03
299	24-06-2021	11:44:54,144	49,925	1497,8	57,81	0,95	84,95	48,16
300	24-06-2021	11:45:09,240	49,913	1497,5	56,22	0,95	84,80	48,26
301	24-06-2021	11:45:24,296	49,925	1497,8	57,08	0,95	84,91	48,22
302	24-06-2021	11:45:39,470	49,925	1498	55,61	0,95	84,94	48,23
303	24-06-2021	11:45:54,505	49,938	1498,4	55,86	0,95	84,94	48,33
304	24-06-2021	11:46:09,625	49,9	1497,3	56,84	0,95	84,94	48,34
305	24-06-2021	11:46:24,433	49,938	1498,1	56,11	0,95	84,91	48,24
306	24-06-2021	11:46:39,821	49,925	1498,1	57,08	0,95	84,95	48,24
307	24-06-2021	11:46:54,847	49,875	1496,4	56,84	0,95	84,91	48,21
308	24-06-2021	11:47:09,824	49,988	1499,8	56,22	0,95	84,91	48,23
309	24-06-2021	11:47:24,606	49,988	1499	56,95	0,95	84,83	48,15
310	24-06-2021	11:47:39,694	49,925	1497,9	56,59	0,95	84,83	47,93
311	24-06-2021	11:47:54,818	49,963	1499,1	56,95	0,95	84,91	48,04
312	24-06-2021	11:48:09,860	49,975	1499,5	56,34	0,95	84,80	47,96
313	24-06-2021	11:48:24,898	49,95	1499,1	55,73	0,95	84,80	48,04
314	24-06-2021	11:48:39,955	50,038	1501	56,34	0,95	84,79	48,07
315	24-06-2021	11:48:55,113	50,013	1500,6	56,84	0,95	84,66	48,07
316	24-06-2021	11:49:10,157	50,013	1500,5	56,34	0,95	84,69	47,96
317	24-06-2021	11:49:25,194	50,05	1500,8	56,84	0,95	84,79	47,91
318	24-06-2021	11:49:40,290	50,088	1502,4	56,47	0,95	84,68	48,04
319	24-06-2021	11:49:55,131	50,038	1501,5	56,47	0,95	84,80	48,07
320	24-06-2021	11:50:10,162	50,113	1502,6	55,5	0,95	84,80	48,07
321	24-06-2021	11:50:25,162	50,013	1500,8	56,59	0,95	84,77	47,89
322	24-06-2021	11:50:40,462	49,938	1497,5	57,81	0,95	84,69	48,07
323	24-06-2021	11:50:55,279	49,988	1499,8	54,89	0,95	84,79	47,94
324	24-06-2021	11:51:10,363	50,013	1500,3	55,38	0,95	84,64	47,93
325	24-06-2021	11:51:25,567	49,925	1498,1	56,22	0,95	84,80	47,83



326	24-06-2021	11:51:40,564	49,975	1499,3	56,59	0,95	84,80	48,07
327	24-06-2021	11:51:55,790	50,063	1501,9	56,22	0,95	84,64	48,13
328	24-06-2021	11:52:10,786	50,05	1501,5	55,98	0,95	84,79	48,27
329	24-06-2021	11:52:25,770	50,025	1500,4	54,77	0,95	84,68	48,35
330	24-06-2021	11:52:40,941	50,025	1500,9	56,47	0,95	84,80	48,51
331	24-06-2021	11:52:55,940	50	1501	56,59	0,95	84,95	48,60
332	24-06-2021	11:53:10,802	50,1	1503,6	55,61	0,95	84,83	48,80
333	24-06-2021	11:53:25,833	50,038	1500,9	57,69	0,95	84,83	48,88
334	24-06-2021	11:53:41,026	50,063	1501,9	56,84	0,95	84,95	48,77
335	24-06-2021	11:53:56,065	50,05	1501,9	56,11	0,95	84,95	48,60
336	24-06-2021	11:54:11,113	50,063	1501,9	56,34	0,95	84,95	48,75
337	24-06-2021	11:54:25,965	50,063	1501,6	55,73	0,95	84,95	48,67
338	24-06-2021	11:54:41,085	50,013	1500,8	57,08	0,95	84,95	48,61
339	24-06-2021	11:54:56,233	50,075	1502,4	56,59	0,95	84,95	48,86
340	24-06-2021	11:55:11,248	50,075	1502,5	55,61	0,95	84,95	48,79
341	24-06-2021	11:55:26,356	50,038	1501,1	57,81	0,95	85,05	48,76
342	24-06-2021	11:55:41,185	50,063	1501,8	56,59	0,95	85,05	48,86
343	24-06-2021	11:55:56,461	50,025	1501,1	55,98	0,95	84,95	48,73
344	24-06-2021	11:56:11,320	50,075	1502	57,2	0,95	84,96	48,86
345	24-06-2021	11:56:26,588	50,088	1503,1	56,84	0,95	84,99	48,83
346	24-06-2021	11:56:41,511	49,988	1500,3	56,34	0,95	85,09	48,84
347	24-06-2021	11:56:56,599	50,025	1500,8	57,33	0,95	84,95	48,95
348	24-06-2021	11:57:11,623	50,038	1501,3	57,56	0,95	85,09	48,89
349	24-06-2021	11:57:26,749	50	1500,1	55,5	0,95	84,98	48,78
350	24-06-2021	11:57:41,591	50,075	1502,4	56,22	0,95	85,09	48,88
351	24-06-2021	11:57:56,654	50,075	1502,6	55,86	0,95	84,96	48,70
352	24-06-2021	11:58:11,670	50,063	1502,4	58,06	0,95	84,95	48,78
353	24-06-2021	11:58:26,882	50,05	1501,5	56,11	0,95	84,95	48,79
354	24-06-2021	11:58:41,834	50	1500,4	54,89	0,95	84,95	48,76
355	24-06-2021	11:58:56,989	50,05	1501,6	57,45	0,95	84,96	48,80

356	24-06-2021	11:59:12,068	50	1500,5	57,33	0,95	84,95	48,86
357	24-06-2021	11:59:27,056	50,038	1501,1	56,84	0,95	84,95	48,81
358	24-06-2021	11:59:42,205	50,025	1501,6	55	0,95	84,98	48,88
359	24-06-2021	11:59:57,315	49,988	1499,8	56,59	0,95	85,09	48,87
360	24-06-2021	12:00:12,172	50,013	1500,6	55,86	0,95	84,96	48,70
361	24-06-2021	12:00:27,218	50,038	1501,5	55	0,95	84,95	48,86
362	24-06-2021	12:00:42,215	50	1500,5	55	0,95	84,95	48,78
363	24-06-2021	12:00:57,292	50,088	1503	57,69	0,95	84,96	49,04
364	24-06-2021	12:01:12,512	49,975	1499,4	56,34	0,95	84,95	49,11
365	24-06-2021	12:01:27,326	50,05	1501,9	57,33	0,95	85,05	49,06
366	24-06-2021	12:01:42,414	50,05	1501,8	55,38	0,95	84,96	49,00
367	24-06-2021	12:01:57,529	49,95	1498,4	55,98	0,95	85,09	49,08
368	24-06-2021	12:02:12,678	50,025	1501	56,34	0,95	85,09	49,15
369	24-06-2021	12:02:27,611	50,05	1501,9	56,47	0,95	85,09	49,24
370	24-06-2021	12:02:42,664	50,063	1501,8	57,33	0,95	85,09	49,29
371	24-06-2021	12:02:57,851	50,05	1501,6	56,22	0,95	85,09	49,28
372	24-06-2021	12:03:12,724	49,963	1499	57,56	0,95	85,12	49,14
373	24-06-2021	12:03:27,827	50,038	1502,3	55,25	0,95	85,09	49,03
374	24-06-2021	12:03:43,018	50	1500,3	56,59	0,95	85,09	49,01
375	24-06-2021	12:03:57,907	50,038	1501,1	55,25	0,95	85,09	49,07
376	24-06-2021	12:04:12,924	50	1500,9	57,08	0,95	84,96	49,06
377	24-06-2021	12:04:28,147	50,063	1502,1	55,13	0,95	85,05	48,88
378	24-06-2021	12:04:43,026	50	1500,3	57,08	0,95	85,06	48,88
379	24-06-2021	12:04:58,128	50,05	1501,6	55,38	0,95	84,98	48,81
380	24-06-2021	12:05:13,336	49,95	1498,4	57,45	0,95	85,05	48,80
381	24-06-2021	12:05:28,169	50	1500,1	55,25	0,95	84,95	48,88
382	24-06-2021	12:05:43,169	50,025	1499,8	55,86	0,95	84,95	49,01
383	24-06-2021	12:05:58,316	50	1500,8	56,72	0,95	84,95	48,99
384	24-06-2021	12:06:13,433	49,975	1499,3	56,95	0,95	84,95	49,06
385	24-06-2021	12:06:28,543	49,988	1499,8	56,84	0,95	85,09	49,08

386	24-06-2021	12:06:43,565	50	1500,5	55,98	0,95	85,09	49,08
387	24-06-2021	12:06:58,492	50,063	1502	55,86	0,95	85,09	49,29
388	24-06-2021	12:07:13,549	50,038	1500,4	56,84	0,95	85,09	49,33
389	24-06-2021	12:07:28,499	50	1500,9	56,95	0,95	85,09	49,21
390	24-06-2021	12:07:43,677	50,025	1500,4	55,98	0,95	84,99	49,18
391	24-06-2021	12:07:58,814	49,888	1495,9	55,98	0,95	85,09	49,10
392	24-06-2021	12:08:13,815	50,013	1500,3	55,98	0,95	85,06	49,32
393	24-06-2021	12:08:28,721	50,025	1500,8	56,95	0,95	85,09	49,29
394	24-06-2021	12:08:43,800	49,988	1499,9	56,59	0,95	85,09	49,09
395	24-06-2021	12:08:58,785	49,975	1499,6	56,72	0,95	85,09	49,14
396	24-06-2021	12:09:14,011	50	1499,4	56,11	0,95	85,09	49,06
397	24-06-2021	12:09:29,061	49,925	1498	56,72	0,95	85,09	49,24
398	24-06-2021	12:09:44,101	49,975	1499,1	57,81	0,95	85,09	49,37
399	24-06-2021	12:09:58,945	50,025	1500,9	55,98	0,95	85,13	49,20
400	24-06-2021	12:10:14,105	49,988	1499,6	57,45	0,95	85,09	49,16
401	24-06-2021	12:10:29,364	49,975	1499,4	55,86	0,95	85,09	49,01
402	24-06-2021	12:10:44,108	50	1499,3	57,08	0,95	85,09	49,29
403	24-06-2021	12:10:59,261	50,025	1500,9	56,59	0,95	84,99	49,11
404	24-06-2021	12:11:14,564	50,063	1502,3	56,84	0,95	85,09	49,03
405	24-06-2021	12:11:29,238	50,025	1501	57,45	0,95	85,09	48,96
406	24-06-2021	12:11:44,383	50,013	1500,4	55,98	0,95	85,09	49,07
407	24-06-2021	12:11:59,752	50	1500,8	56,34	0,95	84,99	49,20
408	24-06-2021	12:12:14,578	49,975	1499,3	55,73	0,95	85,09	49,26
409	24-06-2021	12:12:29,613	50,025	1500,8	56,84	0,95	84,99	49,34
410	24-06-2021	12:12:44,572	49,975	1499,4	55,38	0,95	85,06	49,26
411	24-06-2021	12:12:59,949	49,988	1499,5	55	0,95	85,09	49,28
412	24-06-2021	12:13:14,691	50,038	1501,5	56,72	0,95	84,99	49,38
413	24-06-2021	12:13:29,624	49,963	1499	55,5	0,95	84,98	49,32
414	24-06-2021	12:13:44,955	50,025	1500,9	55,73	0,95	85,09	49,39
415	24-06-2021	12:13:59,791	50,05	1501,3	57,2	0,95	85,09	49,33

416	24-06-2021	12:14:15,061	50,013	1500,6	56,11	0,95	85,09	49,12
417	24-06-2021	12:14:30,036	50,038	1501,1	55,86	0,95	85,09	49,14
418	24-06-2021	12:14:45,142	50,05	1501,5	56,47	0,95	84,98	49,18
419	24-06-2021	12:15:00,113	49,938	1498,4	56,34	0,95	85,05	49,18
420	24-06-2021	12:15:14,995	50,075	1502,4	56,22	0,95	85,09	49,07
421	24-06-2021	12:15:30,231	50,075	1502,1	55,13	0,95	85,05	49,19
422	24-06-2021	12:15:45,269	50	1500	56,11	0,95	85,06	49,01
423	24-06-2021	12:16:00,164	50,013	1500,8	56,34	0,95	85,05	49,10
424	24-06-2021	12:16:15,207	50,113	1503	56,34	0,95	84,95	49,06
425	24-06-2021	12:16:30,496	49,975	1499,3	56,34	0,95	85,09	49,03
426	24-06-2021	12:16:45,324	50,05	1502,3	56,22	0,95	84,97	48,82
427	24-06-2021	12:17:00,709	50,038	1501,1	57,45	0,95	84,95	48,80
428	24-06-2021	12:17:15,654	50,063	1502	57,33	0,95	84,95	48,88
429	24-06-2021	12:17:30,772	50,025	1501,5	55,86	0,95	84,95	48,79
430	24-06-2021	12:17:45,689	50,038	1501,4	54,77	0,95	84,92	48,92
431	24-06-2021	12:18:00,951	50,088	1502,8	56,11	0,95	84,95	49,08
432	24-06-2021	12:18:16,036	50,05	1501,6	55	0,95	84,95	49,03
433	24-06-2021	12:18:30,696	50,063	1502,1	56,59	0,95	84,91	48,98
434	24-06-2021	12:18:45,926	50,125	1504,3	57,33	0,95	84,94	48,90
435	24-06-2021	12:19:01,055	50,038	1501,8	56,84	0,95	84,91	48,86
436	24-06-2021	12:19:16,171	50,075	1502,6	56,34	0,95	84,91	48,94
437	24-06-2021	12:19:31,204	50,125	1502,9	56,34	0,95	84,81	48,83
438	24-06-2021	12:19:46,098	50,088	1502,8	55,61	0,95	84,91	49,01
439	24-06-2021	12:20:01,265	50,013	1500,4	55,98	0,95	84,91	49,10
440	24-06-2021	12:20:16,176	50,088	1502,4	56,84	0,95	84,94	49,16
441	24-06-2021	12:20:31,181	50,063	1502,3	56,72	0,95	84,80	49,18
442	24-06-2021	12:20:46,391	50,088	1502,5	56,11	0,95	84,95	49,27
443	24-06-2021	12:21:01,231	50,088	1502,5	56,11	0,95	84,95	49,26
444	24-06-2021	12:21:16,368	50,075	1502,4	56,95	0,95	84,95	49,38
445	24-06-2021	12:21:31,551	50,1	1503,1	54,89	0,95	84,96	49,44

446	24-06-2021	12:21:46,599	50,113	1503,6	56,72	0,95	85,06	49,59
447	24-06-2021	12:22:01,394	50,063	1502,1	56,72	0,95	84,99	49,60
448	24-06-2021	12:22:16,579	50,05	1501,4	55	0,95	85,12	49,80
449	24-06-2021	12:22:31,674	50,1	1503	56,11	0,95	85,24	49,89
450	24-06-2021	12:22:46,756	50,1	1502,8	56,84	0,95	85,23	49,77
451	24-06-2021	12:23:01,755	50,063	1501,9	56,34	0,95	85,24	49,77
452	24-06-2021	12:23:16,799	50,088	1502,8	56,22	0,95	85,23	49,72
453	24-06-2021	12:23:31,836	50,05	1502,3	56,84	0,95	85,24	49,69
454	24-06-2021	12:23:46,855	50,1	1503,8	55,86	0,95	85,24	49,64
455	24-06-2021	12:24:01,801	50,05	1500,6	56,34	0,95	85,24	49,48
456	24-06-2021	12:24:17,048	50,063	1502,3	56,59	0,95	85,24	49,58
457	24-06-2021	12:24:32,086	50,063	1502,5	56,11	0,95	85,21	49,37
458	24-06-2021	12:24:47,268	50,05	1501,8	57,94	0,95	85,09	49,39
459	24-06-2021	12:25:02,148	50,113	1503,3	56,72	0,95	85,09	49,21
460	24-06-2021	12:25:17,089	50,075	1501,8	56,84	0,95	85,09	49,01
461	24-06-2021	12:25:32,241	50,125	1504	55,86	0,95	85,09	48,98
462	24-06-2021	12:25:47,303	50,05	1501,8	57,69	0,95	84,96	48,92
463	24-06-2021	12:26:02,321	50,075	1502,1	58,17	0,95	84,95	48,84
464	24-06-2021	12:26:17,393	50,088	1502,8	55,86	0,95	84,95	48,81
465	24-06-2021	12:26:32,281	50,1	1502,8	55,13	0,95	84,95	48,91
466	24-06-2021	12:26:47,768	50,075	1502,1	58,06	0,95	84,91	48,80
467	24-06-2021	12:27:02,660	50,075	1502,5	55,86	0,95	84,80	48,78
468	24-06-2021	12:27:17,569	50,038	1501,9	56,59	0,95	84,83	48,80
469	24-06-2021	12:27:32,539	50,063	1501,9	57,2	0,95	84,92	48,78
470	24-06-2021	12:27:47,535	50,05	1501,8	56,47	0,95	84,80	48,82
471	24-06-2021	12:28:02,750	50,063	1502,1	55,86	0,95	84,81	49,07
472	24-06-2021	12:28:17,816	50,063	1502,3	57,2	0,95	84,80	48,97
473	24-06-2021	12:28:32,804	50,013	1500,6	57,2	0,95	84,94	48,90
474	24-06-2021	12:28:47,916	50,038	1501,5	56,72	0,95	84,80	48,78
475	24-06-2021	12:29:02,987	50,125	1504	56,11	0,95	84,77	48,77

476	24-06-2021	12:29:17,920	50,05	1501,8	56,11	0,95	84,77	48,78
477	24-06-2021	12:29:33,043	50,1	1503,4	56,34	0,95	84,80	48,70
478	24-06-2021	12:29:48,296	50,063	1501,3	57,33	0,95	84,68	48,76
479	24-06-2021	12:30:03,216	50,063	1501,3	57,81	0,95	84,68	48,61
480	24-06-2021	12:30:18,306	50,025	1500,9	56,47	0,95	84,64	48,78
481	24-06-2021	12:30:33,170	50,063	1502,3	57,56	0,95	84,66	48,61
482	24-06-2021	12:30:48,201	50,063	1501,6	56,59	0,95	84,66	48,78
483	24-06-2021	12:31:03,384	50,038	1501,1	56,72	0,95	84,79	49,00
484	24-06-2021	12:31:18,484	50,025	1501	57,08	0,95	84,80	49,01
485	24-06-2021	12:31:33,503	50,025	1501,4	57,33	0,95	84,68	49,07
486	24-06-2021	12:31:48,361	50	1500	56,59	0,95	84,69	49,16
487	24-06-2021	12:32:03,575	50,063	1501,9	56,34	0,95	84,77	49,01
488	24-06-2021	12:32:18,529	50,063	1501,9	56,34	0,95	84,76	48,99
489	24-06-2021	12:32:33,532	50,063	1501,9	56,11	0,95	84,80	49,15
490	24-06-2021	12:32:48,684	50,013	1500,8	56,72	0,95	84,80	48,89
491	24-06-2021	12:33:03,697	50,013	1500,5	56,47	0,95	84,80	49,07
492	24-06-2021	12:33:18,837	50,013	1500,4	57,08	0,95	84,69	48,91
493	24-06-2021	12:33:33,833	50,05	1501,8	56,34	0,95	84,80	49,01
494	24-06-2021	12:33:48,708	50,038	1501,1	57,45	0,95	84,80	49,18
495	24-06-2021	12:34:03,818	49,963	1499,4	56,34	0,95	84,79	49,24
496	24-06-2021	12:34:18,782	50,05	1501,3	56,84	0,95	84,80	49,18
497	24-06-2021	12:34:33,868	50,063	1501,9	56,59	0,95	84,94	49,22
498	24-06-2021	12:34:49,151	50,05	1501,1	57,08	0,95	84,92	49,40
499	24-06-2021	12:35:04,195	50,013	1500,5	57,08	0,95	84,92	49,38
500	24-06-2021	12:35:18,992	50,038	1501,5	55,73	0,95	84,94	49,46
501	24-06-2021	12:35:34,283	50,075	1502,5	54,64	0,95	84,95	49,49
502	24-06-2021	12:35:49,313	50,025	1500,8	55,61	0,95	84,95	49,37
503	24-06-2021	12:36:04,385	50,013	1500,4	56,47	0,95	84,95	49,29
504	24-06-2021	12:36:19,326	50,038	1501,4	55,61	0,95	84,95	49,18
505	24-06-2021	12:36:34,377	50	1500,3	55,98	0,95	84,95	49,39

506	24-06-2021	12:36:49,284	50,025	1500,9	55,73	0,95	84,95	49,27
507	24-06-2021	12:37:04,323	50,075	1502,4	55,86	0,95	84,95	49,18
508	24-06-2021	12:37:19,460	50	1500	56,95	0,95	84,95	49,22
509	24-06-2021	12:37:34,371	50,1	1503,4	57,08	0,95	84,95	49,42
510	24-06-2021	12:37:49,477	50,05	1501,3	56,72	0,95	84,95	49,42
511	24-06-2021	12:38:04,479	50,05	1501,6	55,25	0,95	84,95	49,49
512	24-06-2021	12:38:19,843	50,1	1503	55,5	0,95	85,06	49,57
513	24-06-2021	12:38:34,561	50,038	1500,6	57,08	0,95	85,09	49,57
514	24-06-2021	12:38:49,836	50,038	1501,8	58,3	0,95	85,09	49,49
515	24-06-2021	12:39:05,113	50	1500,8	54,89	0,95	85,09	49,47
516	24-06-2021	12:39:19,876	50,038	1500,8	56,47	0,95	85,09	49,44
517	24-06-2021	12:39:34,865	50,05	1501,3	56,84	0,95	84,99	49,41
518	24-06-2021	12:39:50,033	50,013	1500,3	54,89	0,95	85,09	49,57
519	24-06-2021	12:40:04,926	50,038	1501,1	56,34	0,95	85,09	49,32
520	24-06-2021	12:40:20,105	50,025	1500,9	56,95	0,95	85,09	49,22
521	24-06-2021	12:40:35,126	50,038	1501,8	57,33	0,95	84,99	49,18
522	24-06-2021	12:40:50,286	50,025	1500,9	56,84	0,95	85,09	49,12
523	24-06-2021	12:41:05,246	49,988	1499,5	57,94	0,95	84,95	49,18
524	24-06-2021	12:41:20,132	50,038	1501,1	57,2	0,95	84,98	49,13
525	24-06-2021	12:41:35,305	50,038	1500,6	56,59	0,95	84,95	49,10
526	24-06-2021	12:41:50,305	50,05	1501,5	55,5	0,95	84,95	49,18
527	24-06-2021	12:42:05,242	49,988	1500,4	56,72	0,95	84,95	49,09
528	24-06-2021	12:42:20,384	49,975	1499,5	55,13	0,95	84,95	48,98
529	24-06-2021	12:42:35,520	50,038	1501,1	56,34	0,95	84,92	49,07
530	24-06-2021	12:42:50,558	50,05	1501,3	57,08	0,95	84,81	49,06
531	24-06-2021	12:43:05,637	50,063	1501,5	56,95	0,95	84,95	48,98
532	24-06-2021	12:43:20,685	50,025	1500,1	57,08	0,95	84,82	48,91
533	24-06-2021	12:43:35,575	50,063	1502,6	57,69	0,95	84,94	48,98
534	24-06-2021	12:43:50,616	50,075	1502,3	56,84	0,95	84,80	48,97
535	24-06-2021	12:44:05,646	49,988	1499,3	55,86	0,95	84,91	48,96

536	24-06-2021	12:44:20,653	50,05	1501,8	56,95	0,95	84,80	48,88
537	24-06-2021	12:44:35,777	50	1500,5	55,86	0,95	84,69	48,88
538	24-06-2021	12:44:50,806	49,975	1499,9	55,73	0,95	84,69	48,80
539	24-06-2021	12:45:06,102	50,038	1501,1	55,98	0,95	84,80	48,86
540	24-06-2021	12:45:21,087	50	1499,4	56,59	0,95	84,80	48,87
541	24-06-2021	12:45:36,122	50	1500,8	57,08	0,95	84,68	48,80
542	24-06-2021	12:45:50,973	50,038	1501,6	58,17	0,95	84,77	48,87
543	24-06-2021	12:46:06,096	49,938	1498,4	55,73	0,95	84,80	48,80
544	24-06-2021	12:46:21,064	50,013	1500,6	56,47	0,95	84,79	48,78
545	24-06-2021	12:46:36,072	49,988	1499,8	57,08	0,95	84,77	48,86
546	24-06-2021	12:46:51,279	49,975	1499,5	56,72	0,95	84,77	48,68
547	24-06-2021	12:47:06,198	50,025	1501,1	56,59	0,95	84,68	48,76
548	24-06-2021	12:47:21,203	50	1500,1	57,81	0,95	84,64	48,77
549	24-06-2021	12:47:36,314	49,925	1497,8	57,69	0,95	84,64	48,77
550	24-06-2021	12:47:51,479	50,025	1500,4	56,72	0,95	84,68	48,61
551	24-06-2021	12:48:06,325	49,975	1499,3	56,72	0,95	84,64	48,66
552	24-06-2021	12:48:21,423	50	1500,4	56,72	0,95	84,64	48,78
553	24-06-2021	12:48:36,579	50,038	1501	56,84	0,95	84,64	48,78
554	24-06-2021	12:48:51,727	49,975	1499,6	56,47	0,95	84,63	48,76
555	24-06-2021	12:49:06,657	49,95	1498,6	57,08	0,95	84,64	48,74
556	24-06-2021	12:49:21,620	49,975	1499,5	57,33	0,95	84,64	48,67
557	24-06-2021	12:49:36,660	49,988	1499,9	56,95	0,95	84,63	48,69
558	24-06-2021	12:49:51,823	50,025	1500,8	56,11	0,95	84,63	48,49
559	24-06-2021	12:50:07,078	49,988	1500	56,95	0,95	84,54	48,52
560	24-06-2021	12:50:21,957	50,025	1501,4	56,72	0,95	84,62	48,55
561	24-06-2021	12:50:37,059	50,05	1501,6	57,69	0,95	84,63	48,67
562	24-06-2021	12:50:52,129	49,988	1499,1	56,84	0,95	84,53	48,59
563	24-06-2021	12:51:07,128	50,025	1500,4	56,72	0,95	84,61	48,64
564	24-06-2021	12:51:22,189	50	1500,3	57,81	0,95	84,54	48,64
565	24-06-2021	12:51:37,073	49,988	1499,6	55,38	0,95	84,60	48,63



566	24-06-2021	12:51:52,289	50,013	1500,1	57,81	0,95	84,51	48,59
567	24-06-2021	12:52:07,397	50,05	1501,5	56,84	0,95	84,51	48,64
568	24-06-2021	12:52:22,139	50	1500,6	55,5	0,95	84,49	48,70
569	24-06-2021	12:52:37,370	50,013	1500,4	57,69	0,95	84,63	48,66
570	24-06-2021	12:52:52,506	50,063	1501,4	57,2	0,95	84,49	48,60
571	24-06-2021	12:53:07,286	49,988	1499,8	56,59	0,95	84,51	48,51
572	24-06-2021	12:53:22,513	49,95	1498,1	57,94	0,95	84,49	48,59
573	24-06-2021	12:53:37,619	49,988	1499,9	57,08	0,95	84,64	48,75
574	24-06-2021	12:53:52,682	50,025	1500,6	57,2	0,95	84,51	48,78
575	24-06-2021	12:54:07,544	50,038	1501	57,45	0,95	84,51	48,69
576	24-06-2021	12:54:22,748	50,013	1500,3	55,5	0,95	84,49	48,73
577	24-06-2021	12:54:37,897	50	1500,6	56,22	0,95	84,51	48,75
578	24-06-2021	12:54:52,703	50,05	1501,6	56,22	0,95	84,60	48,75
579	24-06-2021	12:55:07,985	50	1499,6	57,56	0,95	84,53	48,61
580	24-06-2021	12:55:22,837	50,013	1500,8	55	0,95	84,62	48,86
581	24-06-2021	12:55:37,981	49,988	1500,1	55,86	0,95	84,63	48,78
582	24-06-2021	12:55:52,915	50	1500,3	56,59	0,95	84,53	48,86
583	24-06-2021	12:56:07,953	50,088	1502,5	57,69	0,95	84,54	48,87
584	24-06-2021	12:56:23,102	50,025	1501,8	56,72	0,95	84,54	48,86
585	24-06-2021	12:56:38,174	50,025	1500,9	57,45	0,95	84,54	48,88
586	24-06-2021	12:56:53,226	49,988	1499,4	56,72	0,95	84,63	48,89
587	24-06-2021	12:57:08,033	50,075	1502,3	55,98	0,95	84,62	49,06
588	24-06-2021	12:57:23,360	50,038	1501,5	57,08	0,95	84,64	48,92
589	24-06-2021	12:57:38,173	50,075	1502	57,45	0,95	84,63	48,98
590	24-06-2021	12:57:53,482	50,088	1502,6	57,94	0,95	84,63	48,95
591	24-06-2021	12:58:08,387	50,05	1501,9	56,59	0,95	84,63	48,86
592	24-06-2021	12:58:23,268	50,075	1501,3	56,72	0,95	84,63	48,78
593	24-06-2021	12:58:38,491	50,038	1500,8	55,73	0,95	84,64	48,88
594	24-06-2021	12:58:53,736	50,075	1502,5	57,56	0,95	84,64	48,79
595	24-06-2021	12:59:08,569	50,1	1502,5	57,94	0,95	84,64	48,80

596	24-06-2021	12:59:23,517	50,088	1503,1	57,45	0,95	84,51	48,88
597	24-06-2021	12:59:38,541	50,125	1503,9	55,98	0,95	84,63	48,90
598	24-06-2021	12:59:53,715	50,05	1501,5	57,69	0,95	84,64	49,08
599	24-06-2021	13:00:08,645	50,063	1501,8	56,84	0,95	84,63	49,13
600	24-06-2021	13:00:23,873	50,125	1503,5	56,47	0,95	84,66	49,35
601	24-06-2021	13:00:38,852	50,075	1502,4	56,72	0,95	84,68	49,39
602	24-06-2021	13:00:53,845	50,075	1502,3	55,98	0,95	84,66	49,36
603	24-06-2021	13:01:08,793	50,05	1501,6	55,98	0,95	84,80	49,39
604	24-06-2021	13:01:24,106	50,05	1500,8	56,72	0,95	84,80	49,38
605	24-06-2021	13:01:39,005	50,025	1500,6	57,81	0,95	84,94	49,37
606	24-06-2021	13:01:54,275	50,063	1502,1	55,98	0,95	84,94	49,37
607	24-06-2021	13:02:09,091	50,075	1502,6	55,38	0,95	84,95	49,32
608	24-06-2021	13:02:24,087	50,038	1501,6	55,5	0,95	84,80	49,20
609	24-06-2021	13:02:39,274	50,088	1502,5	56,95	0,95	84,83	49,14
610	24-06-2021	13:02:54,323	50,038	1501,6	56,95	0,95	84,91	49,27
611	24-06-2021	13:03:09,324	50,088	1502,5	55,86	0,95	84,91	49,17
612	24-06-2021	13:03:24,409	49,988	1499,8	56,22	0,95	84,83	49,20
613	24-06-2021	13:03:39,316	50,075	1502,5	55,61	0,95	84,94	48,99
614	24-06-2021	13:03:54,506	50,063	1502,4	57,33	0,95	84,80	49,11
615	24-06-2021	13:04:09,607	49,988	1499,5	55,38	0,95	84,95	49,08
616	24-06-2021	13:04:24,490	50,038	1501	56,72	0,95	84,69	49,01
617	24-06-2021	13:04:39,584	50,05	1501,6	55,38	0,95	84,80	49,06
618	24-06-2021	13:04:54,500	50,013	1500,9	55,61	0,95	84,91	49,04
619	24-06-2021	13:05:09,765	50,038	1501,5	57,2	0,95	84,80	48,98
620	24-06-2021	13:05:24,579	50,038	1501,4	56,84	0,95	84,77	49,12
621	24-06-2021	13:05:39,868	50,063	1502,1	55,98	0,95	84,80	49,18
622	24-06-2021	13:05:55,018	50,013	1501	57,45	0,95	84,91	49,26
623	24-06-2021	13:06:09,774	50,025	1500,8	56,34	0,95	84,91	49,28
624	24-06-2021	13:06:24,944	50,05	1501,4	55,98	0,95	84,82	49,20
625	24-06-2021	13:06:39,934	50,088	1502	57,69	0,95	84,91	49,32

626	24-06-2021	13:06:54,983	50,038	1501	57,2	0,95	84,95	49,29
627	24-06-2021	13:07:10,043	50,025	1501	56,47	0,95	84,92	49,42
628	24-06-2021	13:07:25,192	50,025	1500,9	55,61	0,95	84,95	49,41
629	24-06-2021	13:07:40,039	50,013	1500,9	54,52	0,95	84,83	49,49
630	24-06-2021	13:07:55,260	50,075	1502,1	56,59	0,95	84,98	49,42
631	24-06-2021	13:08:10,251	50,088	1503,3	57,2	0,95	84,98	49,46
632	24-06-2021	13:08:25,205	50,05	1501,5	56,11	0,95	84,95	49,52
633	24-06-2021	13:08:40,379	50,138	1503,8	57,56	0,95	85,06	49,43
634	24-06-2021	13:08:55,292	50,088	1502,5	57,2	0,95	84,95	49,52
635	24-06-2021	13:09:10,302	50,013	1500,1	56,95	0,95	85,09	49,55
636	24-06-2021	13:09:25,549	50,013	1500,4	56,47	0,95	85,09	49,55
637	24-06-2021	13:09:40,390	50,063	1501,6	56,22	0,95	85,05	49,68
638	24-06-2021	13:09:55,600	49,988	1499,9	56,72	0,95	85,09	49,53
639	24-06-2021	13:10:10,721	50,075	1501,9	56,11	0,95	85,09	49,56
640	24-06-2021	13:10:25,678	50,025	1501,3	57,2	0,95	85,09	49,40
641	24-06-2021	13:10:40,623	50,088	1502,5	56,22	0,95	85,06	49,39
642	24-06-2021	13:10:55,857	50	1500,6	57,69	0,95	85,06	49,32
643	24-06-2021	13:11:10,824	50,013	1500,9	56,59	0,95	85,09	49,34
644	24-06-2021	13:11:25,949	50,05	1501,8	56,59	0,95	85,09	49,32
645	24-06-2021	13:11:41,031	50,05	1501,5	56,22	0,95	84,95	49,21
646	24-06-2021	13:11:56,012	50,025	1500,9	55,86	0,95	84,99	49,38
647	24-06-2021	13:12:11,039	50,038	1501,4	56,11	0,95	85,09	49,35
648	24-06-2021	13:12:25,884	50,05	1501,5	55,5	0,95	85,09	49,21
649	24-06-2021	13:12:41,115	50,05	1501,5	57,33	0,95	85,05	49,29
650	24-06-2021	13:12:56,253	50,063	1502,1	55,25	0,95	84,96	49,29
651	24-06-2021	13:13:11,103	50,063	1502	56,84	0,95	84,99	49,13
652	24-06-2021	13:13:26,148	50	1500,5	55,5	0,95	84,98	49,13
653	24-06-2021	13:13:41,427	50	1500,3	58,06	0,95	85,09	49,26
654	24-06-2021	13:13:56,181	50,013	1500,8	56,47	0,95	85,09	49,27
655	24-06-2021	13:14:11,249	50,05	1502,1	55	0,95	84,95	49,32

656	24-06-2021	13:14:26,331	50,013	1500,6	56,47	0,95	84,96	49,44
657	24-06-2021	13:14:41,577	50,025	1500,3	55,86	0,95	85,06	49,63
658	24-06-2021	13:14:56,459	50,038	1500,9	57,2	0,95	85,09	49,91
659	24-06-2021	13:15:11,793	50,013	1500,4	55,73	0,95	85,21	49,81
660	24-06-2021	13:15:26,785	50	1499,8	55,38	0,95	85,21	49,61
661	24-06-2021	13:15:41,495	50	1500,1	56,34	0,95	85,13	49,60
662	24-06-2021	13:15:56,867	49,975	1498,6	56,47	0,95	85,21	49,64
663	24-06-2021	13:16:11,658	49,938	1498,4	56,84	0,95	85,24	49,67
664	24-06-2021	13:16:26,756	50,038	1501,3	56,95	0,95	85,24	49,54
665	24-06-2021	13:16:41,694	50	1500,5	55,98	0,95	85,14	49,53
666	24-06-2021	13:16:56,925	50	1500	56,22	0,95	85,23	49,58
667	24-06-2021	13:17:11,813	50	1499,8	55,73	0,95	85,14	49,69
668	24-06-2021	13:17:27,056	49,988	1499,6	55,5	0,95	85,23	49,74
669	24-06-2021	13:17:41,907	50,05	1502,5	56,34	0,95	85,21	49,85
670	24-06-2021	13:17:57,033	50,05	1501,3	55,73	0,95	85,24	49,99
671	24-06-2021	13:18:12,174	50,05	1501,5	57,33	0,95	85,24	49,92
672	24-06-2021	13:18:27,202	50,05	1501,6	55,73	0,95	85,24	49,99
673	24-06-2021	13:18:42,083	49,913	1497,4	56,95	0,95	85,24	49,88
674	24-06-2021	13:18:57,384	49,95	1498,6	55,5	0,95	85,24	49,81
675	24-06-2021	13:19:12,261	50	1499,5	57,33	0,95	85,24	49,72
676	24-06-2021	13:19:27,365	50,025	1500,4	56,34	0,95	85,24	49,69
677	24-06-2021	13:19:42,300	49,988	1499,6	57,2	0,95	85,24	49,52
678	24-06-2021	13:19:57,522	49,988	1500	55	0,95	85,24	49,66
679	24-06-2021	13:20:12,481	49,975	1499,4	57,08	0,95	85,14	49,60
680	24-06-2021	13:20:27,657	49,95	1498,8	55,38	0,95	85,13	49,67
681	24-06-2021	13:20:42,656	49,975	1499,8	57,56	0,95	85,14	49,82
682	24-06-2021	13:20:57,705	50,013	1500	56,95	0,95	85,24	49,67
683	24-06-2021	13:21:12,621	50,038	1501	56,47	0,95	85,24	49,71
684	24-06-2021	13:21:27,821	50,038	1501,6	55,13	0,95	85,24	49,64
685	24-06-2021	13:21:42,903	49,988	1500	55,25	0,95	85,21	49,74

686	24-06-2021	13:21:57,763	49,95	1498,4	56,47	0,95	85,24	50,00
687	24-06-2021	13:22:12,727	50	1499,9	55,73	0,95	85,24	50,09
688	24-06-2021	13:22:27,973	49,9	1498,3	56,11	0,95	85,36	50,01
689	24-06-2021	13:22:42,935	49,975	1499,6	56,59	0,95	85,36	49,99
690	24-06-2021	13:22:57,922	50,013	1500,5	55,61	0,95	85,39	49,81
691	24-06-2021	13:23:13,180	49,988	1500	57,2	0,95	85,28	50,09
692	24-06-2021	13:23:28,147	50,013	1500,4	56,84	0,95	85,28	50,03
693	24-06-2021	13:23:43,158	49,963	1499	56,59	0,95	85,39	50,03
694	24-06-2021	13:23:58,352	50,013	1499,8	55	0,95	85,39	50,03
695	24-06-2021	13:24:13,211	50,063	1501,3	56,47	0,95	85,38	50,11
696	24-06-2021	13:24:28,314	49,988	1500,1	55,38	0,95	85,38	50,08
697	24-06-2021	13:24:43,437	50,063	1502	56,11	0,95	85,38	49,97
698	24-06-2021	13:24:58,445	50	1500,4	56,47	0,95	85,28	50,08
699	24-06-2021	13:25:13,558	49,95	1498,8	55,5	0,95	85,39	50,02
700	24-06-2021	13:25:28,450	49,963	1499,1	55,13	0,95	85,39	50,11
701	24-06-2021	13:25:43,653	49,988	1499,9	55,98	0,95	85,36	50,01
702	24-06-2021	13:25:58,707	50,025	1501,8	56,34	0,95	85,25	50,00
703	24-06-2021	13:26:13,488	50,025	1501	55	0,95	85,35	50,01
704	24-06-2021	13:26:28,599	50,088	1502,4	55,86	0,95	85,25	50,08
705	24-06-2021	13:26:43,633	50,05	1501	56,95	0,95	85,38	50,02
706	24-06-2021	13:26:58,831	49,975	1499,8	56,47	0,95	85,25	50,13
707	24-06-2021	13:27:13,725	50,038	1501,3	56,84	0,95	85,36	50,05
708	24-06-2021	13:27:28,936	50,013	1500,6	56,22	0,95	85,29	50,04
709	24-06-2021	13:27:43,932	50,05	1501,1	55,61	0,95	85,36	50,01
710	24-06-2021	13:27:58,879	50,013	1501,3	55	0,95	85,28	49,89
711	24-06-2021	13:28:14,130	49,988	1499,9	57,2	0,95	85,36	49,73
712	24-06-2021	13:28:28,908	50	1500	54,64	0,95	85,35	49,72
713	24-06-2021	13:28:44,095	50,025	1500,5	56,84	0,95	85,24	49,69
714	24-06-2021	13:28:59,148	50,063	1501,4	56,59	0,95	85,24	49,57
715	24-06-2021	13:29:14,190	50,013	1500,6	55,73	0,95	85,24	49,67

716	24-06-2021	13:29:29,384	50,038	1501,6	55,38	0,95	85,24	49,66
717	24-06-2021	13:29:44,352	50,025	1500,5	56,47	0,95	85,24	49,68
718	24-06-2021	13:29:59,384	49,988	1499,8	55,98	0,95	85,09	49,88
719	24-06-2021	13:30:14,296	50,038	1501,5	55,13	0,95	85,09	49,99
720	24-06-2021	13:30:29,380	50,063	1502	55,5	0,95	85,24	50,03
721	24-06-2021	13:30:44,556	50,088	1501,9	55,25	0,95	85,11	50,21
722	24-06-2021	13:30:59,600	50,038	1501	55,86	0,95	85,24	50,29
723	24-06-2021	13:31:14,737	50,05	1501,3	56,59	0,95	85,25	50,31
724	24-06-2021	13:31:29,667	50,025	1501,5	56,72	0,95	85,39	50,26
725	24-06-2021	13:31:44,887	50,088	1502,5	55,13	0,95	85,28	50,31
726	24-06-2021	13:31:59,780	50,1	1502,9	54,89	0,95	85,39	50,18
727	24-06-2021	13:32:14,983	50,025	1500,4	56,59	0,95	85,38	50,08
728	24-06-2021	13:32:29,976	50,05	1501	56,47	0,95	85,25	50,03
729	24-06-2021	13:32:45,002	50,025	1500,4	55,86	0,95	85,36	49,95
730	24-06-2021	13:33:00,058	50,075	1502,6	54,77	0,95	85,36	50,01
731	24-06-2021	13:33:15,087	50,025	1500,6	55,61	0,95	85,36	49,94
732	24-06-2021	13:33:29,967	50,088	1502,3	54,77	0,95	85,39	50,01
733	24-06-2021	13:33:45,204	50,063	1502	55,86	0,95	85,36	50,11
734	24-06-2021	13:34:00,173	50	1500,4	54,64	0,95	85,39	49,99
735	24-06-2021	13:34:15,185	50,088	1502,4	55,73	0,95	85,28	49,92
736	24-06-2021	13:34:30,160	50,038	1501,4	55,98	0,95	85,35	49,91
737	24-06-2021	13:34:45,289	50,013	1500,9	57,56	0,95	85,14	49,62
738	24-06-2021	13:35:00,463	50,013	1500,8	55,61	0,95	85,14	49,60
739	24-06-2021	13:35:15,592	50,063	1502,1	55,5	0,95	85,14	49,89
740	24-06-2021	13:35:30,543	50	1500,1	56,34	0,95	85,23	49,91
741	24-06-2021	13:35:45,633	50,15	1504,3	55,98	0,95	85,14	49,88
742	24-06-2021	13:36:00,619	50,063	1502,3	55,38	0,95	85,23	49,69
743	24-06-2021	13:36:15,624	50,063	1501,6	55,13	0,95	85,12	49,57
744	24-06-2021	13:36:30,721	50,088	1502,8	56,95	0,95	85,21	49,71
745	24-06-2021	13:36:45,831	50,088	1502,8	54,89	0,95	85,21	49,83

746	24-06-2021	13:37:00,865	50,125	1503,5	55,86	0,95	85,13	49,91
747	24-06-2021	13:37:15,819	50,038	1501,3	56,84	0,95	85,14	49,83
748	24-06-2021	13:37:30,876	50,075	1502,5	56,72	0,95	85,21	50,00
749	24-06-2021	13:37:46,148	50,113	1503,1	56,95	0,95	85,14	50,09
750	24-06-2021	13:38:00,894	50,038	1500,3	55,73	0,95	85,21	49,86
751	24-06-2021	13:38:16,134	50,113	1503,8	56,11	0,95	85,14	49,88
752	24-06-2021	13:38:31,249	50,075	1502,1	57,08	0,95	85,21	49,73
753	24-06-2021	13:38:46,309	50,088	1502,3	56,59	0,95	85,09	49,75
754	24-06-2021	13:39:01,372	50,113	1503,6	55,98	0,95	85,21	49,57
755	24-06-2021	13:39:16,231	50,013	1500,5	55,5	0,95	85,09	49,46
756	24-06-2021	13:39:31,313	50,075	1502,4	56,72	0,95	85,09	49,49
757	24-06-2021	13:39:46,452	50,088	1502,8	56,59	0,95	84,99	49,47
758	24-06-2021	13:40:01,668	50,1	1502,9	57,08	0,95	84,96	49,44
759	24-06-2021	13:40:16,639	50,088	1502,5	56,34	0,95	84,96	49,49
760	24-06-2021	13:40:31,464	50,063	1502	56,47	0,95	84,95	49,49
761	24-06-2021	13:40:46,481	50,075	1502,3	57,56	0,95	84,96	49,49
762	24-06-2021	13:41:01,627	50	1499,9	56,34	0,95	84,95	49,27
763	24-06-2021	13:41:16,820	50,063	1501,5	57,33	0,95	84,95	49,27
764	24-06-2021	13:41:31,566	50,1	1502,9	56,22	0,95	84,83	49,28
765	24-06-2021	13:41:46,876	50,025	1500,9	56,11	0,95	84,81	49,11
766	24-06-2021	13:42:01,898	50,038	1501,3	57,56	0,95	84,80	49,11
767	24-06-2021	13:42:16,882	50,05	1501,9	56,47	0,95	84,83	49,09
768	24-06-2021	13:42:31,962	50,038	1501,3	57,81	0,95	84,80	49,27
769	24-06-2021	13:42:47,103	50,063	1501,9	55,73	0,95	84,91	49,38
770	24-06-2021	13:43:01,932	50,063	1502,1	55,98	0,95	84,83	49,40
771	24-06-2021	13:43:16,942	50,038	1501,5	55	0,95	84,80	49,44
772	24-06-2021	13:43:32,189	50,038	1501,6	56,95	0,95	84,83	49,56
773	24-06-2021	13:43:47,260	50,038	1501,1	55,13	0,95	84,81	49,38
774	24-06-2021	13:44:02,160	50,038	1501,3	56,72	0,95	84,91	49,51
775	24-06-2021	13:44:17,147	50,063	1502,1	56,47	0,95	84,94	49,60

776	24-06-2021	13:44:32,211	50,063	1501,6	55,38	0,95	84,94	49,53
777	24-06-2021	13:44:47,381	49,975	1499,5	56,22	0,95	84,82	49,52
778	24-06-2021	13:45:02,263	50,05	1501,9	55,98	0,95	84,95	49,42
779	24-06-2021	13:45:17,451	50	1500,6	57,2	0,95	84,83	49,17
780	24-06-2021	13:45:32,334	50,063	1502,1	57,69	0,95	84,94	49,22
781	24-06-2021	13:45:47,411	49,988	1499,3	57,56	0,95	84,91	49,48
782	24-06-2021	13:46:02,565	50,025	1500,4	57,08	0,95	84,95	49,48
783	24-06-2021	13:46:17,697	50,013	1500,4	55,86	0,95	84,83	49,59
784	24-06-2021	13:46:32,705	50,013	1499,9	56,34	0,95	84,94	49,60
785	24-06-2021	13:46:47,738	50,025	1501,1	56,72	0,95	84,92	49,71
786	24-06-2021	13:47:02,948	50,038	1501	55,86	0,95	84,95	49,83
787	24-06-2021	13:47:17,718	50,025	1500,9	56,59	0,95	84,95	49,88
788	24-06-2021	13:47:32,993	49,988	1500,4	55,25	0,95	84,96	49,88
789	24-06-2021	13:47:48,223	50,013	1500,8	56,34	0,95	84,96	49,89
790	24-06-2021	13:48:02,818	50,038	1501	56,34	0,95	84,99	49,79
791	24-06-2021	13:48:17,930	50,025	1500,6	55,25	0,95	85,09	49,60
792	24-06-2021	13:48:32,998	49,975	1499,5	55,61	0,95	85,05	49,75
793	24-06-2021	13:48:47,957	49,95	1498,4	54,89	0,95	84,95	49,73
794	24-06-2021	13:49:03,305	49,975	1499,4	56,84	0,95	85,09	49,66
795	24-06-2021	13:49:18,202	49,988	1499,5	55,61	0,95	85,09	49,58
796	24-06-2021	13:49:33,260	50,075	1502,1	57,08	0,95	84,95	49,42
797	24-06-2021	13:49:48,152	50,05	1501,6	55,86	0,95	84,95	49,49
798	24-06-2021	13:50:03,230	50,075	1501,5	57,56	0,95	84,92	49,49
799	24-06-2021	13:50:18,360	50,038	1501,4	56,47	0,95	84,95	49,48
800	24-06-2021	13:50:33,465	50,063	1501,8	56,11	0,95	84,95	49,32
801	24-06-2021	13:50:48,312	50,038	1501,3	55,73	0,95	84,83	49,39
802	24-06-2021	13:51:03,447	50,038	1500,5	55,73	0,95	84,81	49,29
803	24-06-2021	13:51:18,494	50,025	1500,9	56,22	0,95	84,83	49,09
804	24-06-2021	13:51:33,624	49,975	1499,3	56,84	0,95	84,77	49,28
805	24-06-2021	13:51:48,482	50,075	1502,6	55,25	0,95	84,80	49,16





806	24-06-2021	13:52:03,737	50,05	1501,4	55	0,95	84,77	49,18
807	24-06-2021	13:52:19,003	50,025	1500,6	57,45	0,95	84,80	49,16
808	24-06-2021	13:52:33,668	50,113	1502,3	55,5	0,95	84,80	49,29
809	24-06-2021	13:52:48,821	50,038	1500,9	56,59	0,95	84,77	49,29
810	24-06-2021	13:53:04,030	50,038	1501,9	55,13	0,95	84,77	49,35
811	24-06-2021	13:53:18,795	49,988	1499,9	56,11	0,95	84,79	49,38
812	24-06-2021	13:53:33,943	49,988	1499	57,45	0,95	84,66	49,32
813	24-06-2021	13:53:48,978	50,038	1501,4	56,95	0,95	84,80	49,38
814	24-06-2021	13:54:04,052	50	1500,3	55,5	0,95	84,69	49,46
815	24-06-2021	13:54:19,047	50,063	1502,1	56,11	0,95	84,79	49,39
816	24-06-2021	13:54:34,293	50,025	1500,6	57,33	0,95	84,80	49,44
817	24-06-2021	13:54:49,187	50,038	1501,1	57,45	0,95	84,80	49,49
818	24-06-2021	13:55:04,267	50,038	1501,3	56,47	0,95	84,80	49,46
819	24-06-2021	13:55:19,291	49,988	1500,4	57,33	0,95	84,77	49,24
820	24-06-2021	13:55:34,196	50,063	1501,1	57,08	0,95	84,64	49,18
821	24-06-2021	13:55:49,309	50,025	1500,9	57,2	0,95	84,69	49,10
822	24-06-2021	13:56:04,379	50,05	1501,1	55,13	0,95	84,68	49,06
823	24-06-2021	13:56:19,553	50,05	1501,8	56,95	0,95	84,76	49,07
824	24-06-2021	13:56:34,653	49,988	1499,5	55,25	0,95	84,77	49,03
825	24-06-2021	13:56:49,479	50,038	1500,5	57,69	0,95	84,64	48,97
826	24-06-2021	13:57:04,569	50	1500,8	56,84	0,95	84,64	49,18
827	24-06-2021	13:57:19,869	50,038	1501,8	56,72	0,95	84,64	49,23
828	24-06-2021	13:57:34,713	50,063	1501,4	56,59	0,95	84,76	49,28
829	24-06-2021	13:57:49,892	50	1500,3	56,95	0,95	84,68	49,18
830	24-06-2021	13:58:04,824	50,025	1501	56,47	0,95	84,77	49,20
831	24-06-2021	13:58:20,113	49,988	1500,4	56,11	0,95	84,66	49,04
832	24-06-2021	13:58:34,957	50,038	1501	57,45	0,95	84,79	49,08
833	24-06-2021	13:58:49,925	50,075	1502,6	56,72	0,95	84,64	49,13
834	24-06-2021	13:59:04,937	50,1	1502,9	55,5	0,95	84,64	49,10
835	24-06-2021	13:59:19,913	50,088	1503,1	56,22	0,95	84,64	49,13

836	24-06-2021	13:59:35,296	50,038	1501,1	55,61	0,95	84,64	49,18
837	24-06-2021	13:59:50,200	50,05	1501,8	55	0,95	84,64	49,17
838	24-06-2021	14:00:05,151	50,05	1501,8	55,86	0,95	84,62	48,99
839	24-06-2021	14:00:20,239	49,975	1500	57,33	0,95	84,64	49,24
840	24-06-2021	14:00:35,314	50,038	1501,1	57,08	0,95	84,63	49,20
841	24-06-2021	14:00:50,548	50,013	1500,8	55,61	0,95	84,66	49,38
842	24-06-2021	14:01:05,533	50,013	1500,1	55,73	0,95	84,76	49,32
843	24-06-2021	14:01:20,558	50,05	1501,5	55,25	0,95	84,68	49,46
844	24-06-2021	14:01:35,715	50,025	1500,1	57,08	0,95	84,68	49,27
845	24-06-2021	14:01:50,704	50,063	1501,6	57,45	0,95	84,64	49,21
846	24-06-2021	14:02:05,850	50,05	1501,5	55,5	0,95	84,64	49,18
847	24-06-2021	14:02:20,859	50,05	1501,5	56,11	0,95	84,79	49,48
848	24-06-2021	14:02:35,966	50	1500,1	56,47	0,95	84,79	49,37
849	24-06-2021	14:02:50,827	49,988	1500,5	55,5	0,95	84,66	49,22
850	24-06-2021	14:03:06,007	50,05	1501,4	56,95	0,95	84,68	49,28
851	24-06-2021	14:03:21,072	50,063	1502,4	57,08	0,95	84,66	49,31
852	24-06-2021	14:03:36,169	50,05	1501,6	55,61	0,95	84,79	49,24
853	24-06-2021	14:03:50,978	50	1500	57,45	0,95	84,68	49,27
854	24-06-2021	14:04:06,135	50,038	1501,4	55,61	0,95	84,77	49,18
855	24-06-2021	14:04:21,208	50,05	1501,8	56,47	0,95	84,64	49,01
856	24-06-2021	14:04:36,345	50,038	1500,5	57,81	0,95	84,64	48,92
857	24-06-2021	14:04:51,098	49,975	1499,1	55,86	0,95	84,64	49,03
858	24-06-2021	14:05:06,181	50	1500	55,86	0,95	84,62	49,16
859	24-06-2021	14:05:21,306	49,988	1500,3	56,72	0,95	84,64	49,29
860	24-06-2021	14:05:36,305	50,025	1501,6	57,33	0,95	84,62	49,16
861	24-06-2021	14:05:51,470	50,075	1502,1	55,5	0,95	84,63	49,20
862	24-06-2021	14:06:06,618	50,05	1501,8	57,08	0,95	84,64	49,44
863	24-06-2021	14:06:21,463	50,025	1501	55,86	0,95	84,66	49,26
864	24-06-2021	14:06:36,639	50,013	1500,6	57,56	0,95	84,66	49,26
865	24-06-2021	14:06:51,727	50,1	1503,3	56,84	0,95	84,64	49,18

866	24-06-2021	14:07:06,581	50	1500,4	56,22	0,95	84,63	49,07
867	24-06-2021	14:07:21,813	50,025	1500,4	56,95	0,95	84,64	48,98
868	24-06-2021	14:07:36,775	49,925	1497,9	55,13	0,95	84,64	49,06
869	24-06-2021	14:07:51,945	50	1499,9	55,5	0,95	84,63	49,04
870	24-06-2021	14:08:06,842	49,963	1499,1	56,34	0,95	84,63	49,18
871	24-06-2021	14:08:21,970	49,988	1499,5	55,73	0,95	84,53	48,97
872	24-06-2021	14:08:37,113	50,025	1500,4	55,98	0,95	84,63	48,97
873	24-06-2021	14:08:52,051	50,013	1500,4	55,5	0,95	84,62	49,04
874	24-06-2021	14:09:07,065	49,913	1497,9	56,84	0,95	84,63	49,12
875	24-06-2021	14:09:22,256	49,975	1499	55,73	0,95	84,64	49,31
876	24-06-2021	14:09:37,291	49,95	1498,8	56,72	0,95	84,64	49,29
877	24-06-2021	14:09:52,105	50,013	1500,6	56,95	0,95	84,64	48,97
878	24-06-2021	14:10:07,225	49,913	1497,8	55,38	0,95	84,64	49,19
879	24-06-2021	14:10:22,254	50	1499,4	55,98	0,95	84,63	49,11
880	24-06-2021	14:10:37,297	49,938	1498,3	55,61	0,95	84,63	49,12
881	24-06-2021	14:10:52,354	49,938	1498,5	56,22	0,95	84,64	49,19
882	24-06-2021	14:11:07,338	49,925	1497,9	56,84	0,95	84,64	49,10
883	24-06-2021	14:11:22,392	49,938	1498,3	56,22	0,95	84,49	48,78
884	24-06-2021	14:11:37,569	49,925	1497,9	57,56	0,95	84,51	48,87
885	24-06-2021	14:11:52,657	49,925	1497,8	56,84	0,95	84,60	48,70
886	24-06-2021	14:12:07,696	49,938	1498,5	55,98	0,95	84,53	48,75
887	24-06-2021	14:12:22,729	49,913	1497,1	55,86	0,95	84,49	48,49
888	24-06-2021	14:12:37,829	49,925	1498	55,86	0,95	84,39	48,50
889	24-06-2021	14:12:52,670	49,95	1498,3	55,25	0,95	84,49	48,57
890	24-06-2021	14:13:07,775	49,938	1498,6	56,22	0,95	84,46	48,50
891	24-06-2021	14:13:22,897	49,925	1497,9	54,89	0,95	84,49	48,48
892	24-06-2021	14:13:37,856	49,925	1497,8	56,84	0,95	84,38	48,75
893	24-06-2021	14:13:53,064	49,938	1498,4	56,47	0,95	84,46	48,73
894	24-06-2021	14:14:07,942	49,913	1497,4	55,98	0,95	84,46	48,55
895	24-06-2021	14:14:23,105	49,863	1495,9	55,38	0,95	84,49	48,51

896	24-06-2021	14:14:38,081	49,925	1497,6	56,95	0,95	84,32	48,52
897	24-06-2021	14:14:53,373	49,938	1498	56,22	0,95	84,32	48,39
898	24-06-2021	14:15:08,236	49,9	1497,4	55,73	0,95	84,32	48,39
899	24-06-2021	14:15:23,090	49,925	1498,4	56,47	0,95	84,21	48,44
900	24-06-2021	14:15:38,349	49,85	1495,6	56,11	0,95	84,24	48,59
901	24-06-2021	14:15:53,249	49,888	1496,9	57,81	0,95	84,34	48,70
902	24-06-2021	14:16:08,409	49,95	1498,3	57,81	0,95	84,35	48,69
903	24-06-2021	14:16:23,355	49,85	1496,4	55,73	0,95	84,35	48,72
904	24-06-2021	14:16:38,625	49,95	1498,9	55,98	0,95	84,38	48,87
905	24-06-2021	14:16:53,669	49,9	1497	55,98	0,95	84,36	48,78
906	24-06-2021	14:17:08,485	49,938	1498,1	55	0,95	84,39	48,88
907	24-06-2021	14:17:23,508	49,85	1495,9	56,72	0,95	84,36	48,88
908	24-06-2021	14:17:38,694	49,938	1498,3	56,11	0,95	84,46	48,78
909	24-06-2021	14:17:53,536	49,888	1496,6	55,73	0,95	84,49	48,88
910	24-06-2021	14:18:08,832	49,938	1498,1	55,38	0,95	84,49	48,97
911	24-06-2021	14:18:23,920	49,888	1496,8	56,59	0,95	84,49	49,01
912	24-06-2021	14:18:38,784	49,975	1499,4	56,11	0,95	84,49	48,98
913	24-06-2021	14:18:53,989	49,9	1496,9	55,98	0,95	84,49	49,00
914	24-06-2021	14:19:08,900	49,975	1499,5	56,59	0,95	84,49	48,90
915	24-06-2021	14:19:23,886	49,95	1498,9	57,69	0,95	84,49	48,98
916	24-06-2021	14:19:39,017	49,9	1497,3	57,33	0,95	84,49	49,06
917	24-06-2021	14:19:54,081	49,9	1497,9	55,98	0,95	84,46	48,92
918	24-06-2021	14:20:09,178	49,938	1498,3	55,98	0,95	84,51	48,96
919	24-06-2021	14:20:24,292	49,95	1498,6	55,73	0,95	84,51	49,08
920	24-06-2021	14:20:39,307	49,888	1497	57,69	0,95	84,51	48,88
921	24-06-2021	14:20:54,206	49,925	1497,6	55,38	0,95	84,63	49,06
922	24-06-2021	14:21:09,189	49,95	1498,9	56,47	0,95	84,63	49,06
923	24-06-2021	14:21:24,290	49,95	1498,8	57,33	0,95	84,60	48,97
924	24-06-2021	14:21:39,268	49,95	1498,5	57,08	0,95	84,64	48,98
925	24-06-2021	14:21:54,717	49,925	1497,9	56,11	0,95	84,49	48,92

926	24-06-2021	14:22:09,387	49,925	1498,5	56,47	0,95	84,49	48,88
927	24-06-2021	14:22:24,395	49,913	1497,5	56,84	0,95	84,53	48,86
928	24-06-2021	14:22:39,721	49,925	1498,6	56,59	0,95	84,49	48,77
929	24-06-2021	14:22:54,766	49,925	1496,8	56,34	0,95	84,35	48,78
930	24-06-2021	14:23:09,756	49,863	1495,8	56,22	0,95	84,36	48,77
931	24-06-2021	14:23:24,580	49,925	1498,5	56,22	0,95	84,38	48,52
932	24-06-2021	14:23:39,659	49,838	1495,5	55,5	0,95	84,49	48,64
933	24-06-2021	14:23:54,833	49,963	1498,6	56,34	0,95	84,39	48,67
934	24-06-2021	14:24:09,808	49,913	1497,4	55,73	0,95	84,46	48,66
935	24-06-2021	14:24:24,840	49,888	1496,9	55,98	0,95	84,35	48,78
936	24-06-2021	14:24:39,820	49,9	1497,8	55,13	0,95	84,49	48,43
937	24-06-2021	14:24:55,165	49,913	1497,5	56,95	0,95	84,35	48,32
938	24-06-2021	14:25:09,972	49,938	1498,1	57,08	0,95	84,21	48,32
939	24-06-2021	14:25:25,046	49,863	1495,9	56,72	0,95	84,32	48,59
940	24-06-2021	14:25:40,251	49,863	1495,5	56,34	0,95	84,32	48,66
941	24-06-2021	14:25:55,126	49,9	1497,1	56,84	0,95	84,35	48,66
942	24-06-2021	14:26:10,250	49,9	1497,3	56,84	0,95	84,35	48,62
943	24-06-2021	14:26:25,255	49,9	1497,1	55,25	0,95	84,24	48,60
944	24-06-2021	14:26:40,273	49,9	1496,4	57,45	0,95	84,24	48,52
945	24-06-2021	14:26:55,232	49,85	1495,9	55,5	0,95	84,34	48,50
946	24-06-2021	14:27:10,325	49,913	1498,1	56,95	0,95	84,35	48,46
947	24-06-2021	14:27:25,596	49,925	1497,8	57,33	0,95	84,20	48,43
948	24-06-2021	14:27:40,501	49,913	1497,4	56,34	0,95	84,24	48,57
949	24-06-2021	14:27:55,599	49,9	1497,5	56,34	0,95	84,34	48,55



	<b>INFORME TÉCNICO DE LA PRUEBA: “POTENCIA MÁXIMA” CENTRAL PLACILLA (revisión 1)</b> Código: PPM-CEN024-2021-CC-DCO-0	
	miércoles 08 septiembre 2021	
Mandante	Revisión 1	Proveedor

## ANEXO I (ACTA DE PRUEBA)

379



Realiza	Francisco Gorigoitia Acuña	Revisa	Patricio Febre Cisternas	Aprueba	Coordinador Eléctrico Nacional
Cargo	Ingeniero de Proyectos	Cargo	Experto Técnico	Cargo	
Firma		Firma		Firma	
Fecha	08/09/2021	Fecha	08/09/2021	Fecha	08/09/2021

INGENIERÍA, MANTENIMIENTO Y EFICIENCIA ENERGÉTICA SPA, RUT: 76.696.552-0, Dirección: Errázuriz #1178, Oficina N° 75, Valparaíso, E-mail: [PATRICIO.FEBRE@IMEE.CL](mailto:PATRICIO.FEBRE@IMEE.CL), Contacto: +56-9-93279529, Sitio Web: [WWW.IMEE.CL](http://WWW.IMEE.CL).

	<b>ACTA DE PRUEBA: “POTENCIA MÁXIMA”</b> <b>CENTRAL PLACILLA</b> Código: PPM-CEN024-2021-CC-DCO-0	
	Jueves 24 junio 2021	
Mandante	Revisión 0	Proveedor

**PARTICIPANTES DE LA PRUEBA**

Ítem	Nombre y Apellido	Cargo / Empresa	Email
1	Fiorella Carla Roncagliolo de la Horra	Subgerente de Comercialización de Energía / TECNORED	<a href="mailto:froncagl@tecnored.cl">froncagl@tecnored.cl</a>
2	Moisés Antonio Vásquez Vásquez	Jefe Área Generación Eléctrica / TECNORED	<a href="mailto:mvasquez@tecnored.cl">mvasquez@tecnored.cl</a>
3	Patricio Febre Cisternas	Experto Técnico / IMEE	<a href="mailto:patricio.febre@imee.cl">patricio.febre@imee.cl</a>
4	Francisco Javier Gorigoitia Acuña	Ingeniero de Proyectos / IMEE	<a href="mailto:francisco.gorigoitia@imee.cl">francisco.gorigoitia@imee.cl</a>
5	Armin Lohrmann	Ingeniero de Cálculo y/o Experto Técnico / IMEE	<a href="mailto:arminlohmanns@gmail.com">arminlohmanns@gmail.com</a>
6	Roberto Moller L	Ingeniero del Departamento de Control de la Operación / Coordinador Eléctrico Nacional	<a href="mailto:roberto.moller@coordinador.cl">roberto.moller@coordinador.cl</a>
7	Eduardo González V.	Ingeniero del Departamento de Control de la Operación / Coordinador Eléctrico Nacional	<a href="mailto:eduardo.gonzalez@coordinador.cl">eduardo.gonzalez@coordinador.cl</a>

	<b>ACTA DE PRUEBA: “POTENCIA MÁXIMA”</b> <b>CENTRAL PLACILLA</b> Código: PPM-CEN024-2021-CC-DCO-0	
	Jueves 24 junio 2021	
Mandante	Revisión 0	Proveedor

### INICIO Y TERMINO DE LA PRUEBA



	Fecha	Hora
Inicio de la prueba	24/06/2021	10:30
Término de la prueba	24/06/2021	15:30

### PRINCIPALES PARÁMETROS TÉCNICOS DE LA PRUEBA

A continuación, se describen algunos parámetros técnicos de la unidad 2 de Central Placilla, la cual se someterá a la prueba de potencia máxima.

Ítem	Descripción del parámetro	Valores	Unidad
1	Marca	CUMMINS ENGINE CO	[-]
2	Modelo	QSK60-G3	[-]
3	Potencia máxima activa bruta	1.200	[kW]
4	Factor de Potencia	0,95	[-]
5	Tipo de Combustible	Diésel	[-]





	<b>ACTA DE PRUEBA: “POTENCIA MÁXIMA”</b> <b>CENTRAL PLACILLA</b> Código: PPM-CEN024-2021-CC-DCO-0	
	Jueves 24 junio 2021	
Mandante	Revisión 0	Proveedor

**OBSERVACIONES ANTES, DURANTE Y DESPUÉS LA PRUEBA**



A continuación, se registran todas las observaciones consignadas durante la realización de la prueba de Potencia Máxima en Central Placilla:

Ítem	Observaciones
1	<p>Se inicia reunión de coordinación desde las 08:45 am, junto a todos los participantes de la prueba Coordinado – Experto Técnico – Coordinador, finalizando a las 10:30. El generador se sincroniza a las 08:45 am.</p>
2	<p>Durante las 08:45 a 10:30 hrs se realizan las siguientes observaciones:</p> <p>2.1. Se detecta que el medidor de facturación se encuentra desfasado por 4 horas adicionales. Es decir, a las 09:08 am en el medidor de facturación marca las 13:08. Para lograr una verificación se posiciona un smartphone físicamente con la hora del SHOA y la hora del medidor de facturación (Se adjunta imagen de ejemplo).</p> <div style="text-align: center;">  </div> <p>2.2. Se espera lograr 1200 [kW] por unidad.  2.3. Se visualizan las pantallas SCADA, de la temperatura ambiente, pantallas de Cummins, y medidor de facturación.  2.4. El coordinador y experto técnico visualizan información por las cámaras y encuentran que es suficiente la información técnica para dar inicio a la prueba.  2.5. Se confirman que durante este periodo todos los parámetros serán descargados vía software cada 5 minutos.  2.6. En el motor 2 (unidad 2) se encuentra el medidor de energía adicional.  2.7. A las 14:30 hora del medidor de facturación comienza la prueba.  2.8. Los motores se encuentran generando a 1200 [kW] antes de iniciar la prueba de manera estable.</p>

	<b>ACTA DE PRUEBA: “POTENCIA MÁXIMA”</b> <b>CENTRAL PLACILLA</b> Código: PPM-CEN024-2021-CC-DCO-0	
	Jueves 24 junio 2021	
Mandante	Revisión 0	Proveedor

3	A las 10:30 hrs se da inicio a la prueba de Potencia Máxima de Central Placilla.
4	Durante la prueba se establecen las siguientes consideraciones: 4.1 Las pruebas de Potencia Máxima y Consumo Específico Neto se realizan el mismo día, es por esto que se establece utilizar las muestras de la prueba de consumo específico neto como dato ya que es el mismo combustible obtenido del estanque principal de la central para las dos pruebas. 4.2 Se definen en forma tripartita (Coordinado – Experto Técnico - Coordinador) en donde el Coordinado entrega las mediciones del medidor de energía de facturación con una tasa de muestreo cada 15 minutos, realizando por parte del Coordinado un respaldo fotográfico cada 15 minutos como se muestra en la foto adjunta en el punto 2 de la presente acta. 4.3 Se crea un grupo de whatsapp oficial con los participantes del Coordinado, Experto Técnico y Coordinador para compartir las fotos en tiempo real del medidor de facturación de energía con el formato descrito en el punto 2 de la presente acta.
5	A las 15:30 hrs se finaliza la prueba de Potencia Máxima de Central Placilla.

### APROBACIÓN DE ACTA

Ítem	Nombre	Cargo / Empresa	Email	Firma
1	Moisés Antonio Vásquez Vásquez	Jefe Área Generación Eléctrica / TECNORED	<a href="mailto:mvasquez@tecnored.cl">mvasquez@tecnored.cl</a>	
2	Patricio Febre Cisternas	Experto Técnico / IMEE	<a href="mailto:patricio.febre@imee.cl">patricio.febre@imee.cl</a>	
3	Eduardo González V.	Ingeniero del Departamento de Control de la Operación / Coordinador Eléctrico Nacional	<a href="mailto:eduardo.gonzalez@coordinador.cl">eduardo.gonzalez@coordinador.cl</a>	