

TRACTEBEL ENGINEERING S.A.

Cerro Colorado 5240, Of. 1601, Ed. Torre del Parque II,
Las Condes, Zip Code 7560995 - Santiago - CHILE
tel. +56 2 2715 8000 - fax +56 2 2715 8001
engineering-cl@tractebel.engie.com
tractebel-engie.com

INFORME TÉCNICO

Código de Documento: P014277-2-GE-INF-00001

Cliente: Bioenergías Forestales

Proyecto: Determinación de Mínimos Técnicos CMPC

Asunto: Informe Central CMPC Cordillera

Comentarios: Central CMPC Cordillera actualiza sus valores de Mínimo Técnico debido a cambio en modo de operación de autoproducer a central térmica convencional.

Revisado conforme a "Observaciones al Informe de Mínimo Técnico Central Termoeléctrica CMPC Cordillera", documento código: COR-GO-DCO-PMAX-CMPC Cordiller-V1

1	20/01/2020	Revisión Final	Ismael Rodríguez	Brian Cleveland	Eduardo Andrzejewski	Eduardo Andrzejewski
0	13/11/2019	Revisión Coordinador	Ismael Rodríguez	Catalina Ortega	Eduardo Andrzejewski	Eduardo Andrzejewski
B	10/10/2019	Revisión CMPC	Catalina Ortega	Ismael Rodríguez	Eduardo Andrzejewski	Eduardo Andrzejewski
A	03/10/2019	Revisión Interna	Catalina Ortega	Ismael Rodríguez	Eduardo Andrzejewski	Eduardo Andrzejewski

REV. DD/MM/AA ESTATUS ESCRITO VERIFICADO APROBADO VALIDADO

TABLA DE CONTENIDO

1. RESUMEN EJECUTIVO	3
2. OBJETIVO.....	4
3. DEFINICIONES Y ABREVIACIONES.....	4
4. DOCUMENTOS Y NORMAS APLICADAS.....	5
5. DESCRIPCIÓN DE LA CENTRAL	6
6. MÍNIMO TÉCNICO.....	7
6.1. Mínimo Técnico de la Unidad.....	7
6.2. Mínimo Técnico Ambiental de la Central	7
6.3. Antecedentes Operacionales	8
6.4. Antecedentes Nacionales.....	11
7. CONCLUSIONES.....	12
8. ANEXOS	12
ANEXO A – INFORMACIÓN TÉCNICA DE LA UNIDAD	13
ANEXO B – DIAGRAMA UNILINEAL DE LA CENTRAL	14
ANEXO C – CARTA DE 00648-17.....	15
ANEXO D – CARTA DE 03707-18	16
ANEXO E – REGISTROS HORARIOS 2018	17

1. RESUMEN EJECUTIVO

La central CMPC Cordillera, de Bioenergías Forestales, ha decidido cambiar su modo de operación de autoprodutor y venta de excedentes a central térmica convencional sujeta al despacho del Coordinador Eléctrico Nacional.

La central utiliza gas natural para producir electricidad mediante una turbina de combustión a gas Rolls-Royce modelo Trent 60. La generación eléctrica es inyectada al Sistema Interconectado en la S/E Puente Alto 110 kV, con una capacidad de 50 MW acorde a lo declarado ante el Coordinador Eléctrico Nacional como Potencia Máxima, y conforme su limitación definida en la RCA 206/2013.

Conforme resolución de la CNE, las empresas generadoras deberán determinar e informar al Coordinador el Mínimo Técnico (MT) de sus unidades generadoras en conformidad a las disposiciones del Anexo Técnico de la Norma Técnica de Seguridad y Calidad de Servicio (NTSyCS) – Resolución exenta N°375.

En este contexto, se determina para la central CMPC Cordillera:

- Mínimo Técnico de 4 MW.
- Mínimo Técnico Ambiental de 30 MW.

Ver justificativas en Capítulo 6.



Figura 1-1: Central CMPC Cordillera.

2. OBJETIVO

El presente documento tiene como objetivo informar y respaldar los valores de Mínimo Técnico de la central CMPC Cordillera, para operación como central térmica convencional utilizando combustible gas natural, conforme a lo establecido en el Anexo Técnico “Determinación de Mínimo Técnico de Unidades Generadoras” de la NTSyCS.

3. DEFINICIONES Y ABREVIACIONES

Definiciones

Mínimo Técnico	Según el Anexo Técnico, se entenderá por Mínimo Técnico la potencia activa bruta mínima con la cual una unidad puede operar en forma permanente, segura y estable inyectando energía al SI en forma continua.
Mínimo Técnico Ambiental	Mínimo Técnico que permite garantizar el cumplimiento de los límites de emisiones que aplican para la central en cuestión.
Unidad	Unidad Generadora (turbina de gas acoplada a su respectivo generador eléctrico).

Abreviaciones

CEMS	Sistema de Monitoreo Continuo de Emisiones
CNE	Comisión Nacional de Energía
DS 13	Decreto Supremo n°13, establece norma de emisión para centrales termoeléctricas
MP	Material Particulado
MT	Mínimo Técnico
MTA	Mínimo Técnico Ambiental
ND	No Disponible
NTSyCS	Norma Técnica de Seguridad y Calidad de Servicio
RCA	Resolución de Calificación Ambiental
S/E	Subestación Eléctrica
SI	Sistema Interconectado
TG	Turbina de Gas

4. DOCUMENTOS Y NORMAS APLICADAS

Los documentos aplicables para la determinación del Mínimo Técnico son los siguientes:

1.	Anexo Técnico: Determinación de Mínimos Técnicos en Unidades Generadoras
2.	DS N°13 Norma de Emisiones para Centrales Termoeléctricas
3.	Resolución Calificación Ambiental del proyecto "Planta de Cogeneración" Resolución Exenta N°206/2013.
4.	Decreto 31: Plan de Prevención y Descontaminación Atmosférica para la Región Metropolitana de Santiago.
5.	Registros Operacionales año 2018
6.	Informe MT central CMPC Cordillera 2018: P010175-2-GE-INF-00002_2

5. DESCRIPCIÓN DE LA CENTRAL

La central CMPC Cordillera, se ubica en la comuna de Puente Alto, a 20 km al sudeste de Santiago. La central entró en operación comercial en septiembre del 2015.

La Tabla 5-1 indica las características principales del conjunto turbina-generator.

Fabricante	Rolls-Royce
Modelo	Trent 60 DLE
Potencia Nominal	53 MW
Sistemas de inyección de agua	Nebulización de entrada y compresión húmeda
Generador	SGen5-100A-2P 086-23 M07
Punto de Conexión al SI	S/E Puente Alto 110 kV

Tabla 5-1: Características principales del turbogenerador de central Cordillera.

La Tabla 5-2 resume las condiciones de operación normal de la central.

Parámetros	Valor	Referencia / Observación
Potencia Máxima	50 MW	Carta DE 00648-17 (Anexo C). Limitada por RCA.
Mínimo Técnico	4 MW	Carta DE03707-18 (Anexo D)
Consumos Eléctricos Auxiliares	0,9 MW	Informe Prueba de Potencia Máxima

Tabla 5-2: Características de operación normal de la central Cordillera.

La Figura 5-1 muestra un diagrama de flujo simplificado de la central CMPC Cordillera.



Figura 5-1: Diagrama simplificado de la central CMPC Cordillera.

La unidad no posee combustible alternativo y no participa del control de frecuencia.

6. MÍNIMO TÉCNICO

Como unidad generadora, se deben considerar las restricciones de la turbina a gas y las limitaciones ambientales.

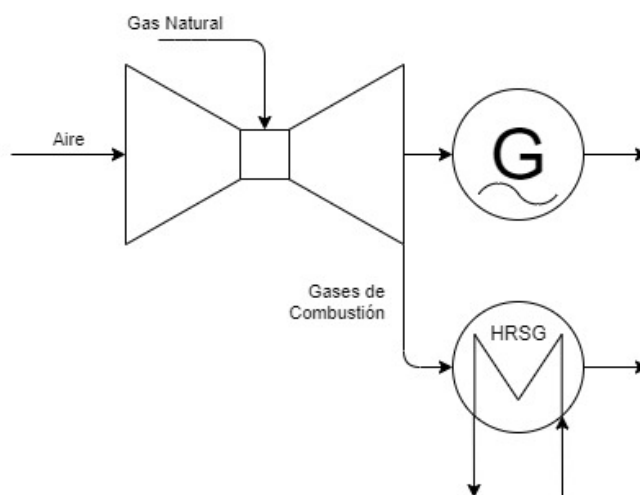
6.1. Mínimo Técnico de la Unidad

La división de operación de la central Cordillera informa que el sistema de control de la turbina sincroniza la unidad con una carga inicial mínima de 4 MW. Ver set point en Figura 6-1.



Figura 6-1: Captura de pantalla del sistema de control del generador.

No se producen cambios en el Mínimo Técnico de la unidad, se mantiene el valor de 4 MW indicado en la carta de aceptación DE 03707-18.

6.2. Mínimo Técnico Ambiental de la Central

La central CMPC Cordillera debe cumplir con los límites de emisiones que se indican en la Tabla 6-1.

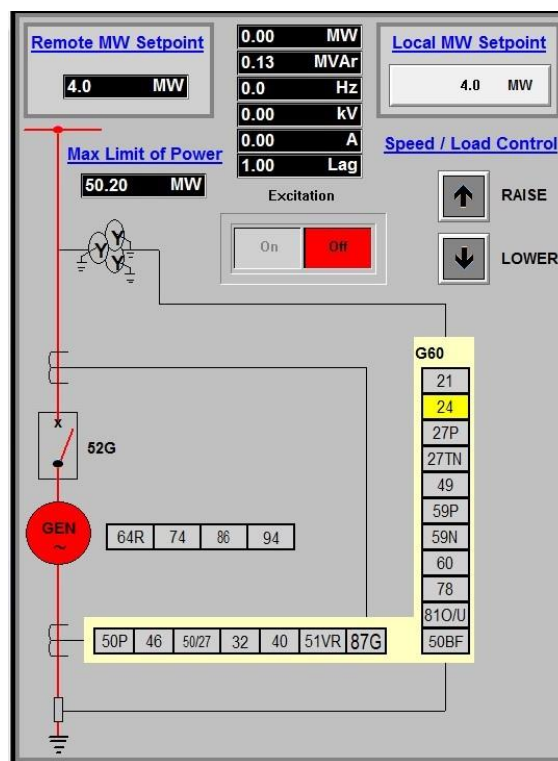
La turbina cuenta con tecnología DLE (*Dry Low Emission*) por lo tanto no utiliza inyección de agua en la cámara de combustión para el control de NOx. Los sistemas de inyección de agua que posee operan en la aspiración de aire (nebulización) y compresor (compresión húmeda) con la finalidad de aumentar el rendimiento y capacidad de la unidad.

Contaminante	Límite	Referencia
CO	100 ppm	Decreto 31 PPDA ¹ , Artículo 40.
NOx	100 ppmv	Decreto 31 PPDA, Artículo 41, caldera existente.
MP	20 mg/m ³ N	Decreto 31 PPDA, Artículo 36.

Tabla 6-1: Límite de emisiones contaminantes central CMPC Cordillera.

Considerando las limitaciones vigentes, las emisiones de CO determinan una restricción operacional que hace necesario definir un Mínimo Técnico Ambiental de 30 MW. Las emisiones de NOx y Material Particulado no imponen restricciones en el Mínimo Técnico Ambiental, dado que se cumplen en todo el rango de carga.

En el siguiente capítulo se presentan los antecedentes operacionales que respaldan la determinación del Mínimo Técnico Ambiental.

6.3. Antecedentes Operacionales

La central Cordillera proporcionó registros horarios del año 2018. **La totalidad de los registros se encuentra en el Anexo E.** En la Figura 6-2 se grafica la curva de potencia bruta horaria.



Figura 6-2: Registro de potencia bruta horario año 2018.

La Figura 6-3 ordenan los registros horarios de potencia bruta en una curva decreciente. Es posible ver que la unidad operó sobre 30 MW cerca del 95% de las horas totales de operación.

¹ PPDA: Plan de prevención y descontaminación atmosférica para la región metropolitana de Santiago.

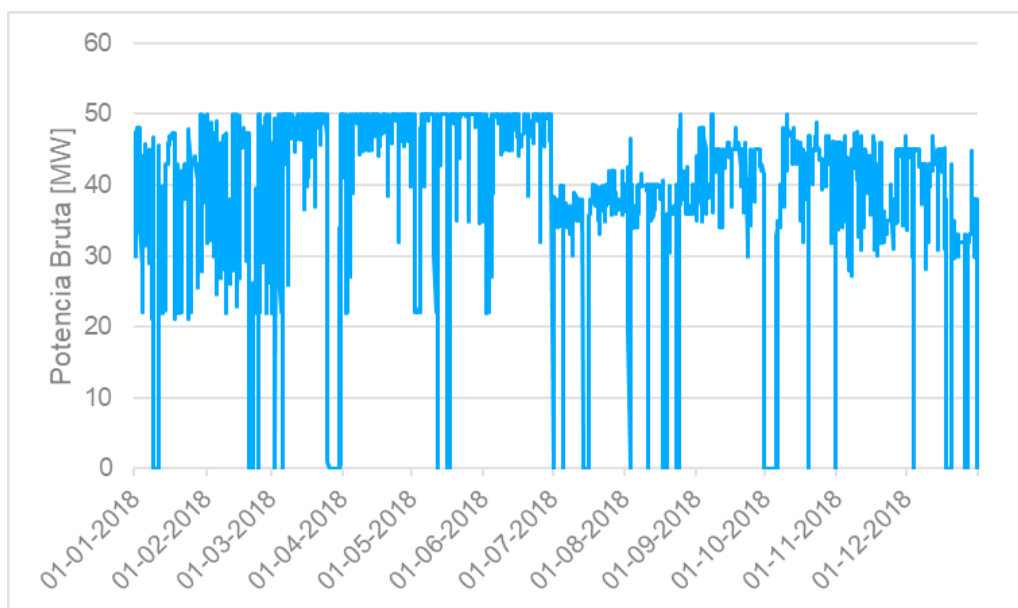

Figura 6-3: Curva decreciente de potencia bruta durante las horas del año 2018.

Las siguientes figuras contienen los registros horarios del CEMS y potencia bruta de la unidad durante el año 2018. En rojo se indican los límites correspondientes. El registro completo se encuentra tabulado en el Anexo E. Los registros podrían contener valores atípicos u anómalos.

La Figura 6-4 muestra el registro horario de emisiones de NO_x y potencia bruta del año 2018. El límite se cumple en todo rango de carga.

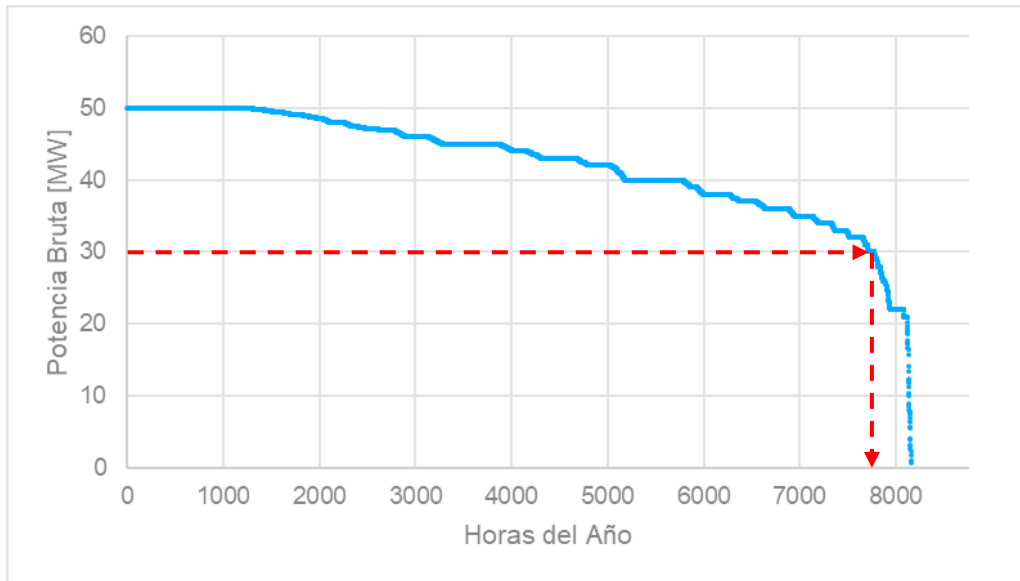

Figura 6-4: Registro de emisiones de NO_x según Potencia Bruta durante el año 2018.

La Figura 6-5 muestra el registro horario de emisiones de MP y potencia bruta del año 2018. El límite se cumple en todo rango de carga, salvo condiciones excepcionales. La Figura 6-6 muestra el mismo registro en detalle (escala reducida).



Figura 6-5: Registro de emisiones de MP según Potencia Bruta durante el año 2018.

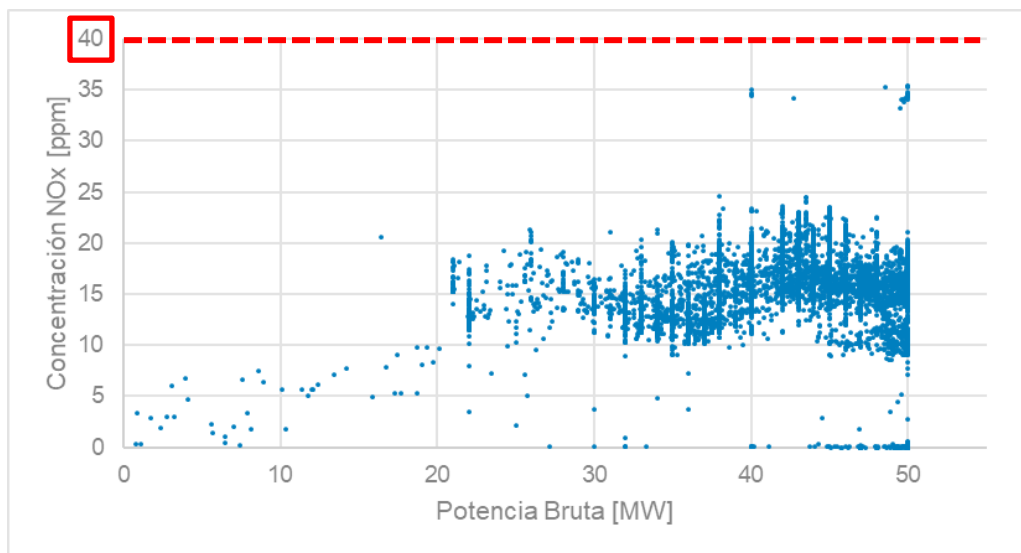

Figura 6-6: Detalle de registro de emisiones de MP según Potencia Bruta durante el año 2018.

La Figura 6-7 muestra el registro horario de emisiones de CO y potencia bruta del año 2018. **En potencias brutas iguales o superiores a 30 MW se cumple el límite de CO en un 97% de los casos (7.527 horas durante el año 2018).**

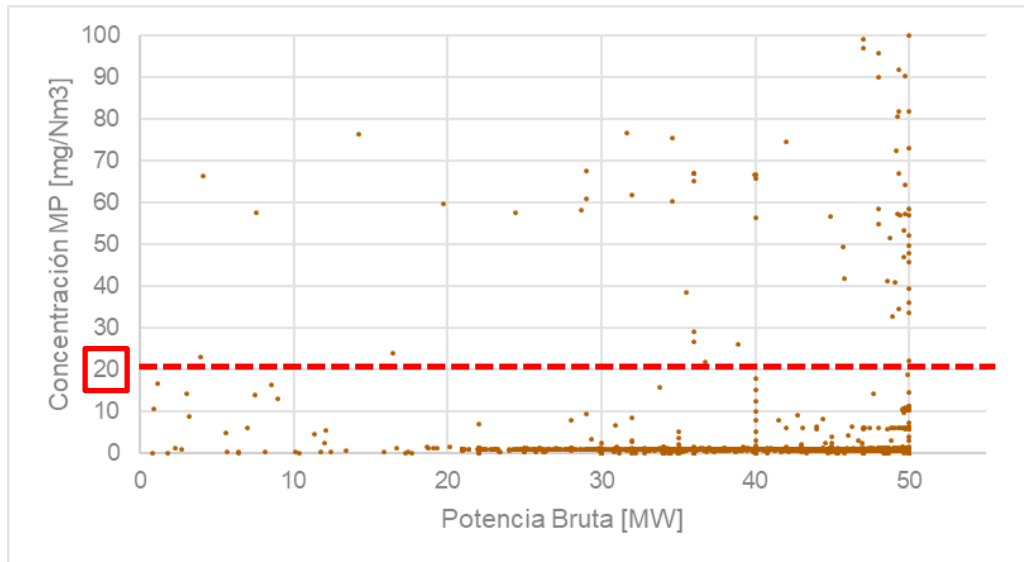

Figura 6-7: Registro de emisiones de CO y Potencia Bruta durante el año 2018.

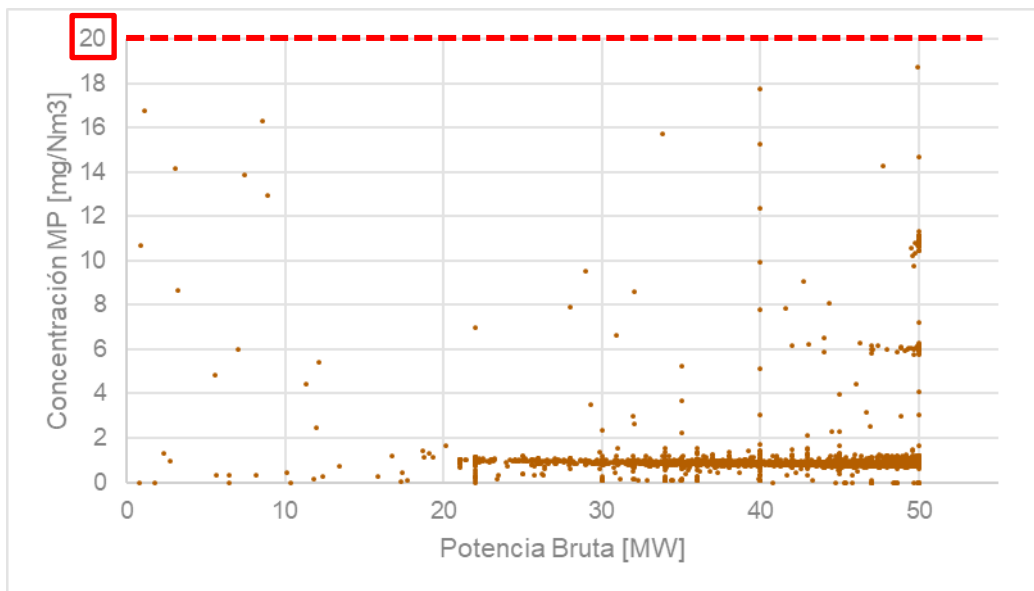
Central CMPC Cordillera confirma que en condiciones normales, se cumple el límite de CO operando desde los 30 MW⁽²⁾.

Considerando las limitaciones vigentes, las emisiones de CO determinan una restricción operacional que hace necesario definir un Mínimo Técnico Ambiental. Las emisiones de NOx y Material Particulado no imponen restricciones en el Mínimo Técnico Ambiental, dado que se cumplen en todo el rango de carga.

En base a los registros anteriores se determina un Mínimo Técnico Ambiental de 30 MW, definido por las emisiones de CO.

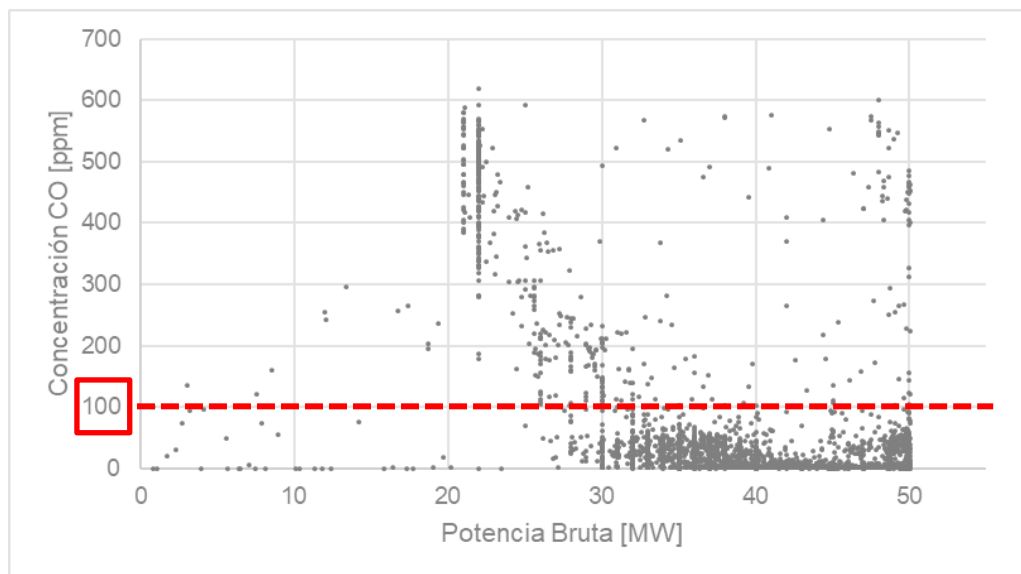
6.4. Antecedentes Nacionales

En el territorio nacional se tiene conocimiento de la central Colmito que posee una unidad Trent 60. Sin embargo, esta unidad posee otro tipo de cámara de combustión tipo WLE (*Wet Low Emission*) la cual utiliza inyección de agua para el control de NOx. En la Tabla 6-2 se indican sus valores de MT y MTA.

Central	Unidad	Mínimo Técnico	Mínimo Técnico Ambiental
Colmito	Trent 60 WLE	4 MW	18 MW *por emisiones de NOx

Tabla 6-2: Antecedentes Nacionales.

² Este valor puede aumentar en condiciones de baja temperatura ambiente.

7. CONCLUSIONES

Considerando el cambio de modo de operación de autoproducción a central convencional y los antecedentes expuestos en los capítulos anteriores:

El Mínimo Técnico de la central Cordillera se mantiene en 4 MW, de acuerdo con la carta DE 03707-18.

El Mínimo Técnico Ambiental de la central Cordillera es de 30 MW, definido por la limitación de emisiones de CO acorde al Decreto 31.

Nota: En el Anexo E se incluye el registro de datos proporcionado por la central Cordillera.

8. ANEXOS

ANEXO A – INFORMACIÓN TÉCNICA DE LA UNIDAD

ANEXO B – DIAGRAMA UNILINEAL DE LA CENTRAL

ANEXO C – CARTA DE 00648-17

ANEXO D – CARTA DE 03707-18

ANEXO E – REGISTROS HORARIOS 2018

ANEXO A – INFORMACIÓN TÉCNICA DE LA UNIDAD



SIEMENS

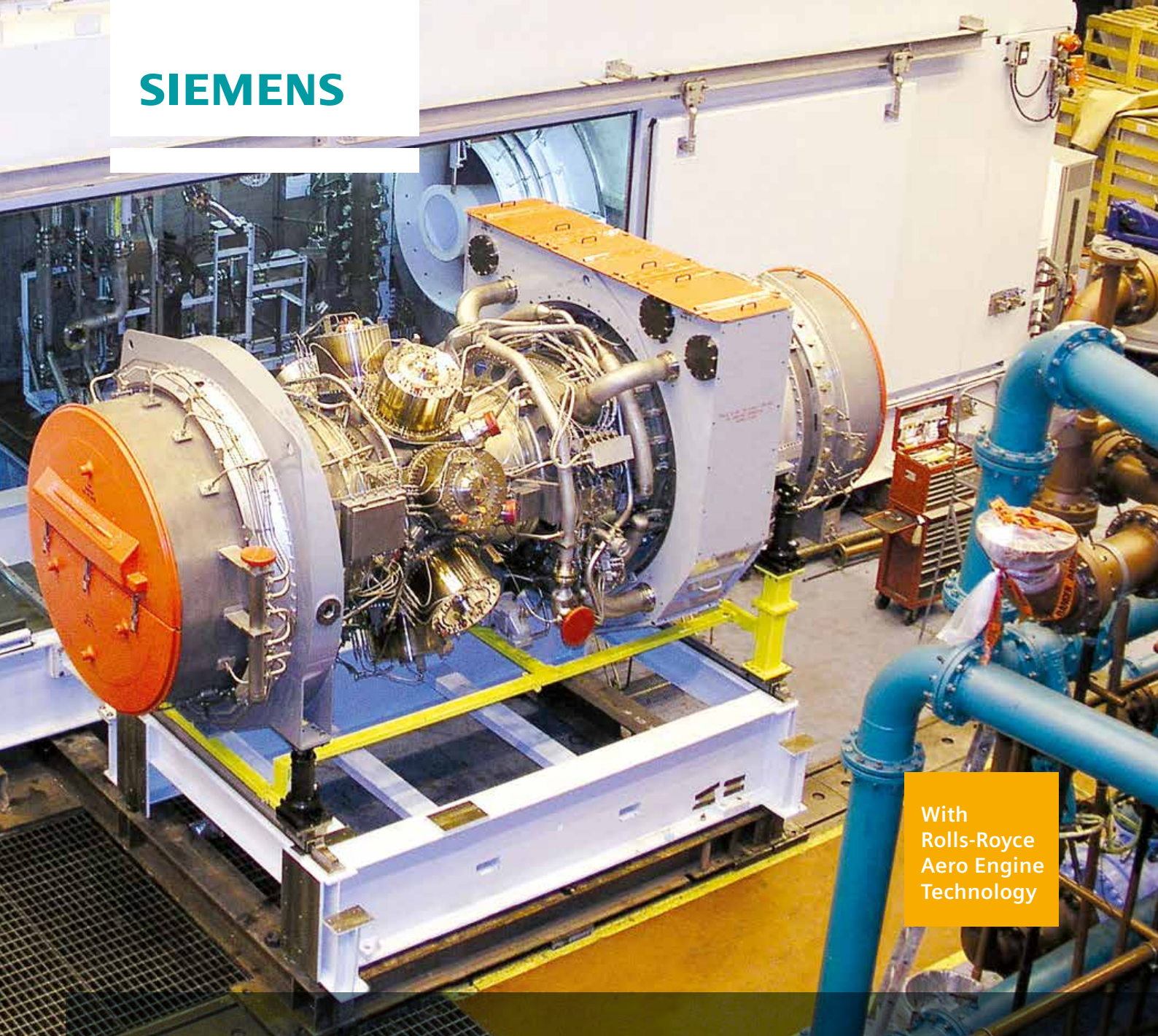

With
Rolls-Royce
Aero Engine
Technology

The Industrial Trent 60 Gas Turbine



Industrial Trent 60 gas turbine

The most advanced aero-derivative gas turbine

The Industrial Trent with Rolls-Royce Aero Engine technology is among the most powerful, pure aero-derived gas turbine in its class on the market today. Designed for industrial use in both power generation and mechanical drive applications, the Industrial Trent 60 has established a new benchmark for power output, fuel economy and cost savings.

In addition to the unmatched power and efficiency of the Industrial Trent 60, customers also experience the benefits of its flexible operation, making it suitable for a variety of applications. Fast delivery and installation of equipment also provides a quicker return on investment for Industrial Trent 60 customers.



The Industrial Trent 60 MD - the best mechanical drive for LNG refrigerant compression

Siemens acquired the Rolls-Royce aero-derivative gas turbine and compressor business effective December 1, 2014. References to Siemens and products are intended to refer to such business as acquired and incorporated into Siemens as from such effective date.

Industrial Trent 60 Mechanical Drive Nominal Performance ISO Conditions, Zero Installation Losses, Natural Gas Fuel

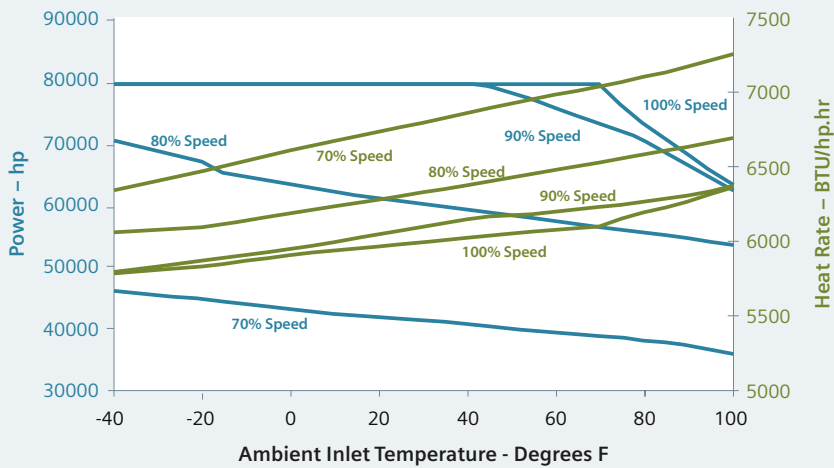

“Designed for industrial use in both power generation and mechanical drive applications, the Industrial Trent 60 has established a new benchmark for power output, fuel economy and cost savings.”

Flexible operation for a variety of applications

Power Generation

One of the most efficient gas turbines on the market, the Industrial Trent 60 provides up to 66MW in simple cycle service at 42.5% efficiency. Its cold start capability and high cyclic life allow it to add power to the grid very rapidly to compensate for the fluctuations and variability of renewable and other power sources, making it ideal for peaking markets.

Key Features for Power Generation

- Meets stringent 25ppm NOx requirements
- Power generation at 50 or 60 Hz without a gear box
- Electric start motor: 175kW and 215kW peak
- Full train black start with 350kW on gas fuel, 450kW on liquid fuel
- High cyclic life meets daily peaking market
- Cold start to full power in under 10 minutes
- Designed for ease of installation and maintenance
- Flexible Combined Cycle
- Combined Heat & Power

Mechanical Drive

The Industrial Trent 60 has the most mechanical drive experience in its class and is ideally suited to meet the higher power, variable speed demands required by applications such as natural gas liquefaction, gas transportation, and gas induction for oil recovery.

Due to its three independent shaft design, the Industrial Trent 60 is capable of meeting driven equipment power demand at reduced speeds with minimal drop off in efficiency.

Key Features for Mechanical Drive

- Designed for 100 percent speed of 3,400 rpm
- Can directly connect to driven equipment or use a gear box
- Controls system supports a variety of driven equipment
- Speed range of 70 to 105 percent
- Full train starting with power as low as 350 KW
- Multiple daily starts with no extended wait time
- High breakaway torque capability
- High inert content fuel capability



Performance data

For power generation applications

Industrial Trent 60 – Dry Low Emissions (DLE)

The Industrial Trent 60 DLE engine is designed to meet stringent environmental requirements. The use of eight radial staged combustors allows the successful operation of the engine in part load operation while still maintaining NO_x and CO compliance. The engine is designed to produce 54MW of power at ISO conditions.

Industrial Trent 60 – Wet Low Emissions (WLE)

The Industrial Trent 60 WLE uses an annular combustor system from the Rolls-Royce Trent aero engine but modified to operate with liquid and gas fuel. The injection of water is used to reduce emissions and boost performance. At ISO conditions the engine is rated for 66MW.

Inlet Spray Intercooling

The Industrial Trent 60 can be offered with an Inlet Spray Intercooling (ISI) system to reduce the ambient inlet temperature and decrease the energy required for compression. This results in higher power and efficiency at ambients above 7°C.

Industrial Trent 60 DLE Nominal Performance
ISO Conditions, Zero Installation Losses, Natural Gas Fuel

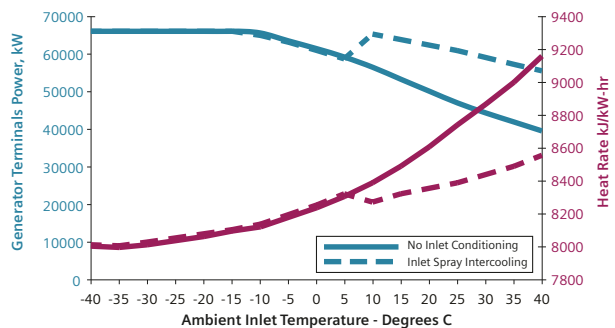

Industrial Trent 60 WLE (Water Injected) Nominal Performance
ISO Conditions, Zero Installation Losses, Natural Gas Fuel

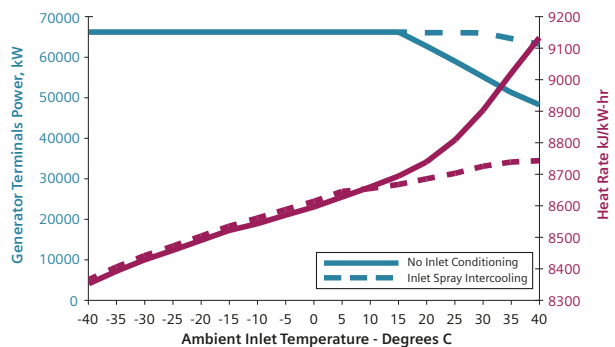

“The Industrial Trent 60 package is designed with a modular concept to allow for quick installation and ease of maintenance in the field.”

Modular for ease of installation and maintenance

Power Generation

The Industrial Trent 60 package is designed with a modular concept to allow for quick installation and ease of maintenance in the field.

Each of the modules is fully assembled and tested before shipment. The gas turbine base plate holds the required oil system to allow installation, testing and flushing in a shop environment. This greatly reduces site installation time.

The control system is designed to allow for easy site installation by using remote I/O technology to decrease the number of interconnect cables between the unit control panel and the equipment skids. All train control systems are then accessed by a Human Machine Interface (HMI) which can be located in the main control room.



Step 1

Install the main gas turbine skid baseplate. This includes all required engine lubrication and fuel systems as well as the remote I/O module.

Step 2

Install the gas turbine enclosure roof, ventilation system, and exhaust transit.

Step 3

Install air filter and support structure.

Step 4

Install auxiliary equipment skids.

Step 5

Install Industrial Trent 60 gas turbine.

Step 6

Install driven equipment. This can be done concurrently with the other steps.



The Industrial Trent 60 engine on a test bed in Montreal, Canada

Maintenance

Quick and easy maintenance

Maintenance of the Industrial Trent 60 engine can be accomplished quickly and easily due to the aero engine design. The package can facilitate engine change out in under 24 hours of working time. Complete engine servicing can take place in a Siemens facility.

Siemens can also offer access to a lease engine or module program. The modular design of the Industrial Trent engine can allow for rapid exchange of components, while detailed work is carried out at a major overhaul facility. This can greatly reduce the turn time for engine maintenance at overhaul. Siemens can also offer access to a lease engine to support customer operations during maintenance.

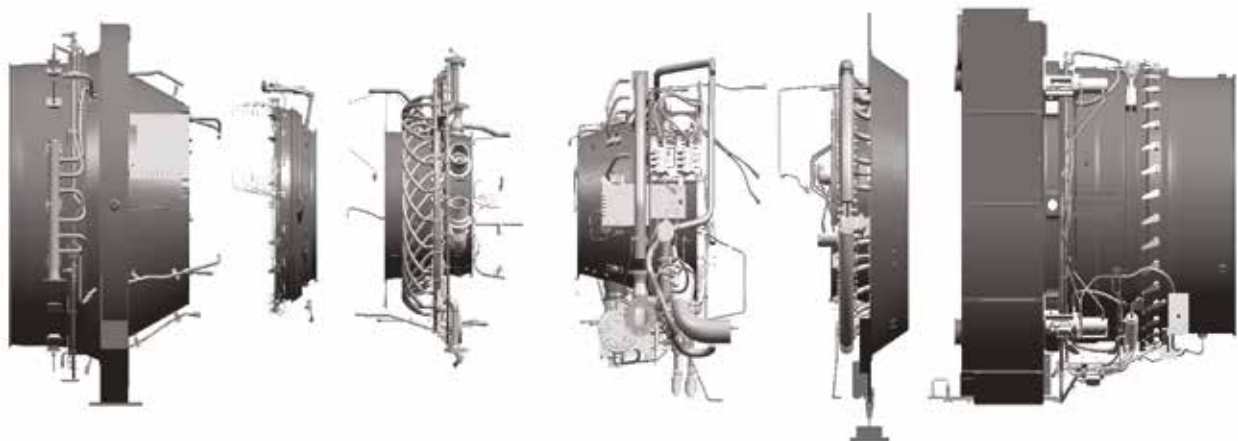



UK power plant utilizes the efficiency and flexibility of the Industrial Trent 60

“The Industrial Trent 60 offers an innovative and diverse suite of service solutions tailored to customers’ specific needs.”

Comprehensive customer service

As the most powerful aero-derivative gas turbine in its class, the Industrial Trent 60 offers distinct advantages to the power generation and oil and gas industries. This competitive advantage is complemented by an innovative and diverse suite of service solutions tailored to customers’ specific needs.

Our ability to keep customers operational is a direct result of our focus to develop customized service solutions for their business. Our service solutions create partnerships designed to share risk and help control operators’ maintenance budgets while maximizing production.

This is accomplished through aligned metrics, priority service and support, and performance and availability guarantees. Utilizing Equipment Health Management (EHM), we can also diligently monitor equipment performance, avoid or minimize unscheduled maintenance, and increase the time between routine overhauls to consistently maximize its life cycle operational efficiency.

Other service options include on-site resident engineers, lease and exchange engine support, spare parts inventory management, and protection against unscheduled maintenance costs.

As equipment continues to operate over time, we are also constantly offering upgrades. These provide the latest technology to maximize output, efficiency, reliability and minimize maintenance, operational costs and emissions.

- Installation & commissioning services
- Spare parts
- Field services
- Technical support
- Customer training
- Repair and overhaul
- Lease and spare engines
- Long term service agreements
- Equipment upgrades
- Package refurbishments

Published by and copyright © 2014:
Siemens AG

Power and Gas
Freyeslebenstrasse 1
91058 Erlangen, Germany

For more information, please contact
our Customer Support Center.
Phone: +49 180 524 70 00
Fax: +49 180 524 24 71
(Charges depending on provider)
E-mail: support.energy@siemens.com

Order No. 50001-G430-A126-X-4A00
WS 1114

Printed on elementary chlorine-free
bleached paper.

All rights reserved. Trademarks
mentioned in this document are the
property of Siemens AG, its affiliates, or
their respective owners. Product Mark
Trent® is a registered trademark of and
used under license from Rolls-Royce plc.

Subject to change without prior notice.
The information in this document
contains general descriptions of the
technical options available, which may
not apply in all cases. The required
technical options should therefore be
specified in the contract.



ANEXO B – DIAGRAMA UNILINEAL DE LA CENTRAL

RELE	FUNCION	INTERRUPTOR				OTROS
		52H-1	52H-13	52D-1	52D-2	
SPAUI 130C	27/59	X	X	X	X	52G1, 52F1, 52F2
SPAUI 110C	59H	X				
L-1	21/21N/50/51/50N/67/67N/78	X				
REB670	87B					86B
TPU 2000R	8711					86T1
	86T1					86T1
	51/51N BT			X		
MICROSHIELD	50/51					86S1
DPU 2000R	50/51			X		
TPU 2000R	8712					86T2
	86T2					86T2
	51/51N BT			X		
MICROSHIELD	50/51					86S2
DPU 2000R	50/51			X		
T3-1	50/50N/51/51N/67/67N		X			86T3-1
T3-2	50/50N/67/67N/87		X			86T3-2
	86T3		X			52G1, 52F1, 52F2, 52H-13

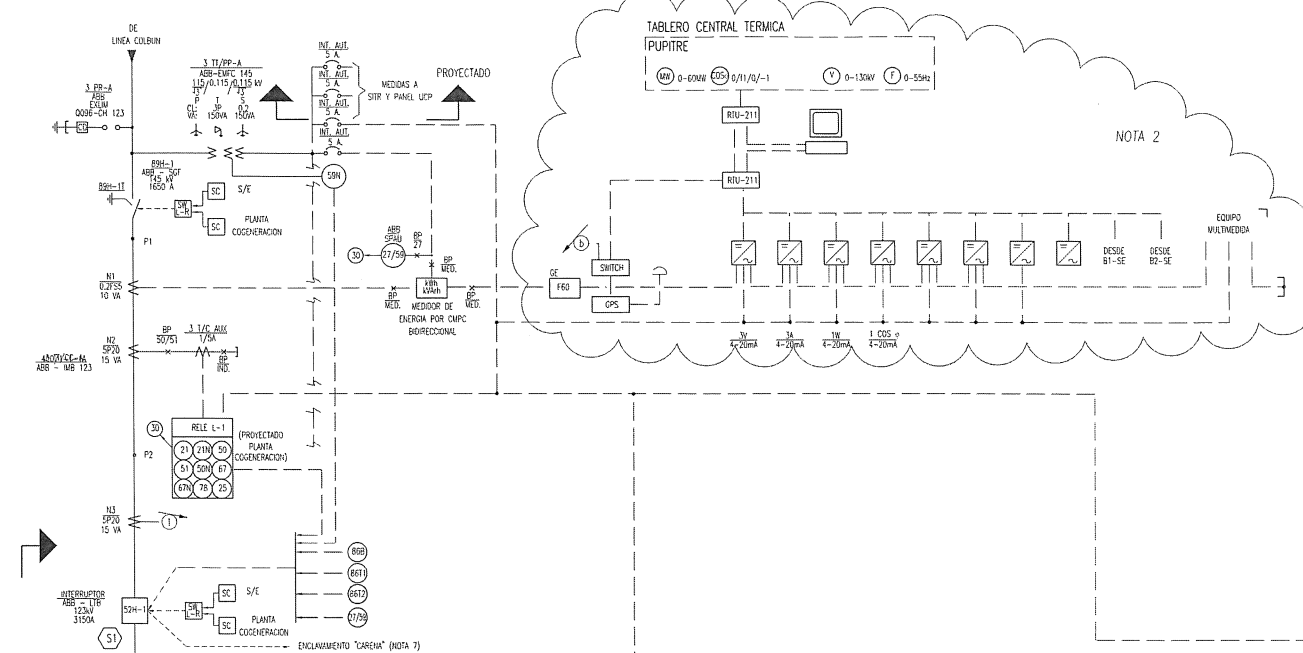

- SIMBOLOGIA**
- ⊕ - PARARRAYOS CON CONTADOR DE DESCARGA
 - ⊖ - DESCONECTOR MOTORIZADO
 - ⊕ - TRANSFORMADOR DE CORRIENTE TIPO BUSHING
- ABREVIACIONES EQUIPOS**
- T - TRANSFORMADOR DE PODER
 - T/C - TRANSFORMADOR DE CORRIENTE
 - T/P - TRANSFORMADOR DE POTENCIAL
 - TA - TRANSFORMADOR DE SERVICIOS AUXILIARES
 - A - AMPERMETRO
 - V - VOLTIETRO
 - KWh - MEDIDOR ENERGIA
 - K - RELE BAJA PRESION SF6
 - F 2 - MANDOSTATO BAJA PRESION SF6
 - SV - SWITCH DE AMPERMETRO
 - 5V - SWITCH DE VOLTIETRO
 - SC - SWITCH CONTROL DE INTERRUPTOR
 - 33 - SWITCH LIMITE CONTROL
 - SW/L-R - SWITCH SELECTOR LOCAL-REMOTO
 - SWC/L - SWITCH LOCAL
 - SC(S/E) - SWITCH REMOTO SUBSTACION
 - SC(C.TERM) - SWITCH REMOTO CENTRAL TERMICA
 - PR - PARARRAYOS
 - FU - FUSIBLE
 - LR - LUZ ROJA
 - LV - LUZ VERDE
 - ME - UNIDAD DE CONTROL ELECTRONICA TIPO ME
 - FS - UNIDAD DE CONTROL ELECTRONICA TIPO FORM 5
 - TM - INTERRUPTOR TERMOMAGNETICO
 - TD - TABLERO DISTRIBUCION
 - CA - CORRIENTE ALTERNIA
 - MF - EQUIPO MULTIFUNCION
 - BP - BLOCK DE PRUEBAS
 - L - LOCAL
 - R - REMOTO
 - S - PUNTO DE SINCRONIZACION
- NUMEROS PROTECCIONES ANSI/IEEE**
- 21 - RELE DE DISTANCIA
 - 24 - INDICADOR DE NIVEL
 - 25 - RELE DE CHECKEO DE SINCRONISMO CON DIF. DE FASE
 - 26 - INDICADOR DE TEMPERATURA DE ACEITE
 - 27 - RELE BAJA VOLTAJE
 - 27P - BAJA VOLTAJE FASE
 - 27TN - BAJA TENSION NEUTRA DEL TERCER ARMONICO
 - 28 - INDICADOR DE FLUJO
 - 30 - PANEL DE ALARMAS
 - 32 - ALIMENTACION DIRECCIONAL
 - 33 - INTERRUPTOR DE POSICION
 - 40 - RELE DE CAMPO
 - 46 - DESBALANCE GENERADOR
 - 49 - TEMPERATURA DE ENROLLADOS DEL TRANSFORMADOR
 - 50 - RELE SOBRECORRIENTE DE FASES INSTANTANEO
 - 50N - RELE SOBRECORRIENTE RESIDUAL INSTANTANEO
 - 50BF - FALLA INTERRUPTOR
 - 50/27 - ENERGOZACION INADVERTIDA
 - 51 - RELE SOBRECORRIENTE DE FASES TEMPORIZADO
 - 51N - RELE SOBRECORRIENTE RESIDUAL TEMPORIZADO
 - 52 - INTERRUPTOR DE POTENCIA
 - 50N - RELE SOBREVOLTAJE NEUTRO
 - 59P - SOBREVOLTAJE FASE
 - 60 - FALLA FUSIBLE VT
 - 62 - RELE TEMPORIZADO
 - 63 - RELE DE ALIHO
 - 69 - DISPOSITIVO DE ENCLAVAMIENTO
 - 71 - INDICADOR DE NIVEL
 - 74 - ALARMA
 - 78 - DETECCION BALANCE POTENCIA
 - 81 - O/U - SOBRE/BAJA FRECUENCIA
 - 84 - MECANISMO CAMBIADOR DERIVACIONES BAJO CARGA
 - 86 - RELE DE TRIP
 - 87 - RELE DIFERENCIAL
 - 89 - SECCIONADOR
 - 90 - RELE REGULADOR
 - 94 - TRIP GENERADOR

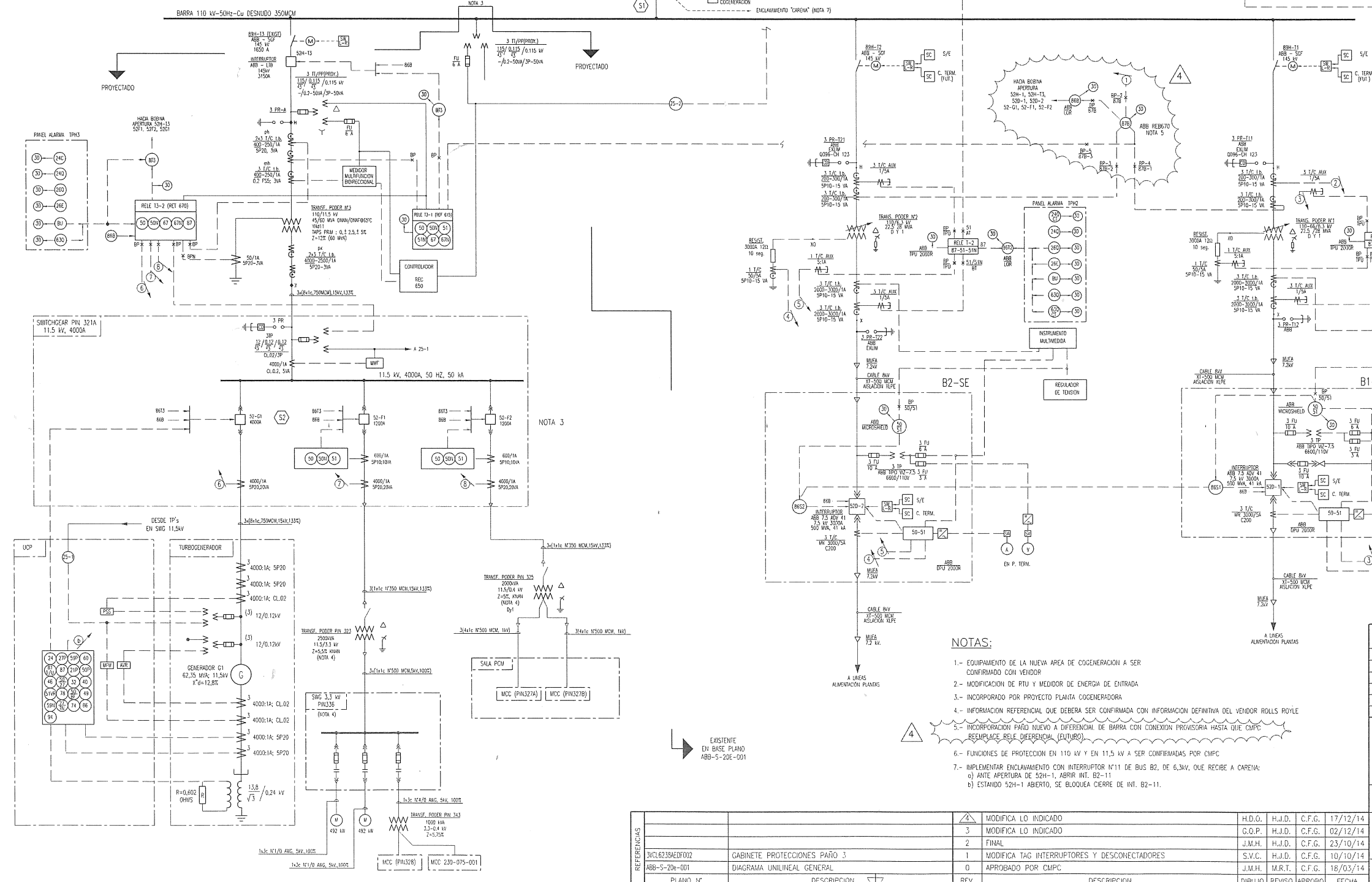

- NOTAS:**
- 1 - EQUIPAMIENTO DE LA NUEVA AREA DE COGENERACION A SER CONFIRMADO CON VENDOR
 - 2 - MODIFICACION DE RTU Y MEDIDOR DE ENERGIA DE ENTRADA
 - 3 - INCORPORADO POR PROYECTO PLANTA COGENERADORA
 - 4 - INFORMACION REFERENCIAL QUE DEBERA SER CONFIRMADA CON INFORMACION DEFINITIVA DEL VENDOR ROLLS ROYCE
 - 5 - INCORPORACION PAÑO NUEVO A DIFERENCIAL DE BARRA CON CONEXION PROVISORIA HASTA QUE CMPC REEMPLACE RELE DIFERENCIAL (FUTURO)
 - 6 - FUNCIONES DE PROTECCION EN 110 kV Y EN 11,5 kV A SER CONFIRMADAS POR CMPC
 - 7 - IMPLEMENTAR ENCLAVAMIENTO CON INTERRUPTOR N11 DE BUS B2, DE 6,3kV, QUE RECIBE A CARGA:
 - a) ANTE APERTURA DE 52H-1, ABRIR INT. B2-11
 - b) ESTANDO 52H-1 ABIERTO, SE BLOQUEA CIERRE DE INT. B2-11.

PROYECTO N°		W40142		AMEC - Cade		amec	
DIBUJO	S. WALDRA C.	FIRMA	FECHA	28/01/14			
PROYECTO	H. JIMENEZ D.	FECHA	28/01/14	N° PLANO	AMEC - CADE		
REVISO	H. JIMENEZ D.	FECHA	28/01/14				
APROBO	C. FUENZALDA G.	FECHA	28/01/14				
				W40142-0222-140-SLD-001			
				4			
PAPELES CORDILLERA S.A.							
PLANTA PUENTE ALTO							
PLANTA COGENERACION							
TITULO							
DIAGRAMA UNILINEAL GENERAL SUB-ESTACION PRINCIPAL Y PLANTA COGENERACION							
N° PLANO CMPC							
C-222-E8A-0001							
ESCALA: 5/ESC							

REFERENCIAS	DESCRIPCION	REV.	DESCRIPCION	DIBUJO	REVISO	APROBO	FECHA
3/CL6238A03002	GABINETE PROTECCIONES PAÑO 3	1	MODIFICA TAG INTERRUPTORES Y DESCONECTADORES	J.M.H.	H.J.D.	C.F.G.	17/12/14
ABB-5-206-001	DIAGRAMA UNILINEAL GENERAL	3	MODIFICA LO INDICADO	G.O.P.	H.J.D.	C.F.G.	02/12/14
		2	FINAL	J.M.H.	H.J.D.	C.F.G.	23/10/14
		1	MODIFICA TAG INTERRUPTORES Y DESCONECTADORES	S.V.C.	H.J.D.	C.F.G.	10/10/14
		0	APROBADO POR CMPC	J.M.H.	M.R.T.	C.F.G.	18/03/14

ANEXO C – CARTA DE 00648-17

Santiago, 16 de febrero de 2017
DE 00648-17

Señor
Chun Yue Chan Pang
Encargado
Bioenergías Forestales S.A.
Presente

Ref.: Informa valores de Potencias Máximas de las centrales CMPC Cordillera y CMPC Tissue.

De nuestra consideración:

En cumplimiento con lo establecido en el Artículo 24 del Anexo Técnico "Pruebas de Potencia Máxima en unidades Generadoras", informo a Ud. los valores de las potencias máximas de las unidades generadoras CMPC Cordillera y CMPC Tissue.

Los informes técnicos del experto técnico que respaldan estos valores se encuentran publicados en nuestra página web en la sección "Informes y Documentos/ Sistema Interconectado Central / Informes y Documentos / Implementación de Anexos Técnicos / Pruebas de Potencia Máxima en Unidades Generadoras Año 2016"

Conforme a lo anterior el valor de los parámetros técnicos de Potencia Máxima se presentan a continuación:

Unidad	Potencia Máxima Medida [MW]	Potencia Máxima Corregida [MW]	Excedentes Medidos [MW]	Excedentes Corregidos [MW]
CMPC Cordillera	50,18	50,16	26,65	26,63
CMPC Tissue	19,57	21,13	2,33	3,90

Al respecto, comunico a Ud., que estos parámetros entrarán en vigencia a partir del 17 de febrero de 2017.

Sin otro particular, saluda atentamente a usted,



Daniel Salazar Jaque
Director Ejecutivo
Coordinador Eléctrico Nacional

c.c.: Archivo
SRyCT/jmc

ANEXO D – CARTA DE 03707-18

Santiago, 24 de agosto de 2018

DE 03707-18

Señores
Encargados
Empresas Coordinadas
Presente

Ref.: Aceptación del Mínimo Técnico de las Centrales Termoeléctricas CMPC Tissue y CMPC Cordillera.

[1] Carta DE02800-18, Ref.: “Informe de Mínimo Técnico de las Centrales CMPC Tissue y CMPC Cordillera, del Coordinado Bioenergías Forestales S.A.”, de fecha 4 de julio de 2018.

De nuestra consideración:

En cumplimiento con lo establecido en el Artículo 11 del Anexo Técnico “Determinación de Mínimos Técnicos en Unidades Generadoras” de la Norma Técnica de Seguridad y Calidad de Servicio, comunicamos a Ud. la aceptación por parte del Coordinador Eléctrico Nacional de los valores de Mínimo Técnico justificados en los Informes Técnicos publicados en el sitio web del Coordinador Eléctrico mediante la comunicación de la Ref. [1].

Adicionalmente, se deja constancia que en el plazo establecido por el Artículo 10 del Anexo Técnico en aplicación, no se recibieron observaciones de Coordinado alguno a los Informes Técnicos indicados en el párrafo anterior.

Considerando lo planteado, los parámetros de Mínimo Técnico de las Unidades de las Centrales CMPC Tissue y CMPC Cordillera se indican en las siguientes tablas:

Tabla N°1: Parámetros de mínimo técnico de las Centrales CMPC Tissue y CMPC Cordillera (Turbina a Gas), conforme al Anexo Técnico

Central	Unidad	Combustible	Mínimo Técnico [MW]
CMPC Tissue	CMPC Tissue	Gas Natural	1,60
CMPC Cordillera	CMPC Cordillera	Gas Natural	4,00

Tabla N°2: Potencia activa excedente mínima de inyección al sistema de las Centrales CMPC Tissue y CMPC Cordillera

Central	Unidad	Combustible	Potencia Activa [MW]
CMPC Tissue	CMPC Tissue	Gas Natural	0,00
CMPC Cordillera	CMPC Cordillera	Gas Natural	5,40 ⁽¹⁾

(1) Valor de Potencia Activa excedente que cumple las restricciones ambientales de CMPC Cordillera.

En cumplimiento del Artículo 12 del Anexo Técnico antes mencionado, los valores de mínimo técnico de las unidades indicadas en las tablas anteriores entrarán en vigencia a partir de las 00:00 horas del martes 28 de agosto de 2018.

Los informes de mínimo técnico de las unidades de las Centrales CMPC Tissue y CMPC Cordillera, que contienen la justificación de los parámetros indicados anteriormente, pueden ser descargados en la siguiente ruta de la página web del Coordinador Eléctrico Nacional:

Inicio >Informes y documentos >Parámetros operacionales de unidades generadoras y auditorías técnicas >Mínimo Técnico >Informes de Mínimos Técnicos Unidades Generadoras:

- 1. >Central CMPC Tissue**
- 2. >Central CMPC Cordillera**

Sin otro particular, saluda atentamente a Ud.,



Ernesto Huber J.
Gerente de Operación
Coordinador Eléctrico Nacional

c.c.:
Sr. Sergio Zamora R. – Encargado Titular Bioenergías Forestales S.A.
SGA/DCO/DAO/SGO/CDN/CDS/SGP/DPRO/DTE/DPE/DAE/DIT/DPR/DCA

ANEXO E – REGISTROS HORARIOS 2018

Registros Horarios CMPC Cordillera 2018

FECHA/HORA	CONCENTRACION_CO_L_PPM	FLUJO_GASES_SALIDA_NM3/H	CONCENTRACION_MP_MG/NM3	CONCENTRACION_NOX_PPM	CONSUMO_COMBUSTIBLE	POTENCIA_BRUTA_MWH
01/01/2018 00:00	2,035	427051,825	0,712	17,463	11955,433	47,501
01/01/2018 01:00	1,933	427083,331	0,716	17,646	11960,5	47,499
01/01/2018 02:00	1,915	423207,172	0,705	17,883	11971,538	47,5
01/01/2018 03:00	2,055	426906,446	0,717	17,637	11963,429	47,498
01/01/2018 04:00	1,973	427037,177	0,726	17,6	11965,048	47,501
01/01/2018 05:00	2,035	421483,099	0,667	17,467	11965,606	47,5
01/01/2018 06:00	2,093	427173,873	0,734	16,791	11969,721	47,502
01/01/2018 07:00	111,766	362810,494	0,708	15,874	9212,802	33,465
01/01/2018 08:00	144,25	343313,819	0,812	15,681	8509,582	30,003
01/01/2018 09:00	60,804	385206,513	0,776	16,198	10116,806	38,339
01/01/2018 10:00	1,846	427711,94	0,733	16,916	11919,057	47,498
01/01/2018 11:00	1,82	423945,407	0,718	16,906	11906,05	47,487
01/01/2018 12:00	1,785	427508,277	0,739	16,866	11863,943	47,212
01/01/2018 13:00	1,746	427685,353	0,738	16,893	11799,425	47,114
01/01/2018 14:00	1,731	426171,741	0,723	16,776	11877,528	47,489
01/01/2018 15:00	1,725	427762,782	0,731	16,919	11862,23	47,5
01/01/2018 16:00	1,719	427963,555	0,733	16,998	11857,843	47,5
01/01/2018 17:00	1,715	426620,633	0,713	17,008	11871,488	47,495
01/01/2018 18:00	1,731	428010,302	0,719	17,126	11907,532	47,501
01/01/2018 19:00	1,735	428079,358	0,729	17,197	11926,138	47,5
01/01/2018 20:00	1,752	428047,426	0,713	17,154	11942,191	47,5
01/01/2018 21:00	1,77	427753,932	0,729	17,246	11952,412	47,498
01/01/2018 22:00	1,806	427826,129	0,737	17,208	11957,089	47,501
01/01/2018 23:00	1,792	424015,274	0,727	17,147	11956,952	47,501
02/01/2018 00:00	1,816	427391,418	0,737	17,011	11962,279	47,5
02/01/2018 01:00	1,832	427504,313	0,743	17,044	11968,844	47,5
02/01/2018 02:00	1,869	423322,117	0,739	16,969	11968,067	47,499
02/01/2018 03:00	1,858	426832,913	0,762	17,432	11968,648	47,5
02/01/2018 04:00	1,867	426974,215	0,754	17,733	11965,557	47,5
02/01/2018 05:00	1,917	422746,705	0,691	17,669	11960,1	47,502
02/01/2018 06:00	1,908	427834,236	0,744	16,904	11961,938	47,502
02/01/2018 07:00	1,819	427739,956	0,678	16,159	11951,671	47,496
02/01/2018 08:00	1,942	423960,953	0,745	15,808	11940,43	47,5
02/01/2018 09:00	1,821	427075,716	0,723	16,074	11919,328	47,489
02/01/2018 10:00	1,811	427136,444	0,714	16,563	11902,14	47,499
02/01/2018 11:00	1,793	423716,394	0,693	17,03	11888,931	47,499
02/01/2018 12:00	1,779	425166,31	0,715	17,011	11871,01	47,499
02/01/2018 13:00	1,75	425578,742	0,722	17,021	11852,731	47,499
02/01/2018 14:00	1,748	424327,026	0,698	16,904	11832,314	47,465
02/01/2018 15:00	1,734	427370,665	0,717	16,875	11814,145	47,456
02/01/2018 16:00	1,733	428201,918	0,72	16,971	11820,442	47,476
02/01/2018 17:00	1,717	427185,401	0,698	17,114	11920,74	47,996
02/01/2018 18:00	1,727	426862,295	0,716	17,23	11932,439	47,995
02/01/2018 19:00	1,741	427241,419	0,717	17,455	11978,145	48,001
02/01/2018 20:00	1,756	426837,203	0,694	17,573	12009,629	47,997
02/01/2018 21:00	1,771	428013,906	0,712	17,646	12024,736	48
02/01/2018 22:00	1,788	427893,403	0,727	17,504	12027,986	48,002
02/01/2018 23:00	1,924	422912,752	0,719	17,395	12026,189	47,999
03/01/2018 00:00	1,844	426536,794	0,734	17,4	12030,997	48
03/01/2018 01:00	1,905	426455,655	0,736	17,704	12030,285	47,972
03/01/2018 02:00	1,84	423739,725	0,735	18,193	12047,817	48
03/01/2018 03:00	1,83	427820,205	0,753	18,232	12050,016	48,002
03/01/2018 04:00	1,911	428233,412	0,744	18,304	12052,336	47,997
03/01/2018 05:00	1,931	424976,219	0,702	18,31	12052,846	47,999
03/01/2018 06:00	3,896	399958,717	0,785	16,609	10422,704	39,72
03/01/2018 07:00	14,46	390622,674	0,704	14,106	9926,252	37,557
03/01/2018 08:00	23,919	377918,699	0,8	13,176	9696,831	36,156
03/01/2018 09:00	19,239	378111,609	0,775	13,126	9623,487	36
03/01/2018 10:00	19,37	377359,354	0,757	13,041	9600,385	36
03/01/2018 11:00	28,864	369285,733	0,654	12,807	9433,721	35,171
03/01/2018 12:00	24,693	383637,569	0,672	14,933	9803,815	37,134
03/01/2018 13:00	50,969	359067,589	0,791	15,858	9089,983	33,531
03/01/2018 14:00	29,865	370528,271	0,653	15,585	9487,397	35,511
03/01/2018 15:00	50,347	371307,297	0,786	18,048	9479,482	35,396
03/01/2018 16:00	10,043	371145,987	0,77	13,659	9458,98	35,569
03/01/2018 17:00	26,964	362246,503	0,659	12,669	9172,627	34,073
03/01/2018 18:00	53,798	364138,561	0,788	14,859	9236,406	34,219
03/01/2018 19:00	18,464	365319,502	0,771	12,563	9259,082	34,376
03/01/2018 20:00	22,637	364444,101	0,751	12,314	9225,981	34
03/01/2018 21:00	27,832	366192,335	0,764	12,316	9244,913	34
03/01/2018 22:00	30	366683,7	0,784	12,239	9252,356	33,998
03/01/2018 23:00	32,796	363703,13	0,77	12,392	9257,44	33,999
04/01/2018 00:00	215,317	336075,817	0,813	15,178	8200,884	28,363
04/01/2018 01:00	305,363	323384,373	0,842	16,396	7780,847	26,001
04/01/2018 02:00	27,354	396682,226	0,764	19,642	10270,196	39,151
04/01/2018 03:00	14,375	405998,158	0,77	20,304	10442,242	39,999
04/01/2018 04:00	13,684	406155,085	0,765	20,437	10443,055	40
04/01/2018 05:00	13,245	404260,693	0,726	20,469	10446,648	40,002
04/01/2018 06:00	16,192	406281,463	0,782	19,988	10445,861	39,999
04/01/2018 07:00	409,452	312095,895	0,738	16,193	7508,566	23,994
04/01/2018 08:00	469,852	296250,725	0,868	15,863	7097,004	22
04/01/2018 09:00		296169,39		16,108	7063,119	21,998
04/01/2018 10:00	418,981	294714,864	0,841	16,352	7033,611	21,998
04/01/2018 11:00	394,668	292066,005	0,822	16,888	7007,394	22,002
04/01/2018 12:00	380,998	291096,23	0,826	17,071	6987,525	21,998
04/01/2018 13:00	380,899	289711,706	0,859	17,168	6977,714	21,999
04/01/2018 14:00	350,502	287592,054	0,839	18,76	6940,845	22,001
04/01/2018 15:00	149,491	310121,16	0,839	21,36	7599,611	25,87
04/01/2018 16:00	47,124	368992,461	0,783	19,631	9373,905	35,056
04/01/2018 17:00	3,673	424186,485	0,714	18,167	11047,012	43,555
04/01/2018 18:00	3,085	428041,666	0,706	16,416	11159,474	44
04/01/2018 19:00	3,741	428532,984	0,71	17,077	11184,965	43,998
04/01/2018 20:00	6,767	428590,649	0,688	17,649	11197,208	44,001
04/01/2018 21:00	5,911	427959,393	0,702	17,975	11219,381	43,999
04/01/2018 22:00	6,817	427787,027	0,724	17,967	11215,087	44
04/01/2018 23:00	8,01	424039,503	0,704	18,033	11213,701	44,002
05/01/2018 00:00	7,841	427722,617	0,71	18,054	11215,745	44
05/01/2018 01:00	7,513	427776,178	0,731	17,929	11213,556	43,997
05/01/2018 02:00	5,112	424272,832	0,698	18,635	11219,84	43,998

05/01/2018 03:00	3,314	427864,984	0,715	19,329	11217,632	44,001
05/01/2018 04:00	4,606	427953,226	0,724	18,962	11221,678	44
05/01/2018 05:00	6,273	425583,396	0,669	18,743	11219,999	44,001
05/01/2018 06:00	3,399	427313,872	0,72	18,221	11609,724	45,822
05/01/2018 07:00	7,685	408348,072	0,725	20,858	10599,435	40,835
05/01/2018 08:00	3,574	422954,034	0,698	17,721	11375,989	44,717
05/01/2018 09:00	2,549	427269,341	0,558	16,639	11405,448	44,999
05/01/2018 10:00	2,602	427540,87	0,73	15,102	11374,48	45
05/01/2018 11:00	2,658	425514,269	0,71	14,69	11319,629	44,727
05/01/2018 12:00	7,803	394232,481	0,748	15,083	10265,408	39,439
05/01/2018 13:00	6,839	371756,647	0,775	13,632	9578,918	36
05/01/2018 14:00	5,778	370165,581	0,763	13,915	9562,577	36
05/01/2018 15:00	4,93	370927,597	0,784	13,952	9525,373	35,999
05/01/2018 16:00	5,044	370704,964	0,784	16,937	9576,05	35,998
05/01/2018 17:00	4,157	371779,17	0,766	13,976	9524,645	36,002
05/01/2018 18:00	24,013	346967,678	0,804	15,171	8789,114	31,837
05/01/2018 19:00	11,055	365133,565	0,789	12,796	9298,32	34,514
05/01/2018 20:00	2,566	364839,619	0,769	16,471	9451,606	35,002
05/01/2018 21:00	15,611	369919,152	0,806	13,193	9436,736	34,999
05/01/2018 22:00	19,034	371771,654	0,801	12,873	9441,695	35,004
05/01/2018 23:00	18,415	369440,822	0,782	12,696	9447,622	35
06/01/2018 00:00	21,349	372450,353	0,816	12,689	9448,164	35
06/01/2018 01:00	20,391	372001,806	0,822	12,76	9450,278	35
06/01/2018 02:00	142,251	349044,209	0,822	13,984	8792,375	31,499
06/01/2018 03:00	115,99	357304,174	0,842	14,117	8961,962	32,381
06/01/2018 04:00	22,968	371448,167	0,82	13,029	9458,665	35,001
06/01/2018 05:00	23,295	369978,009	0,781	12,993	9458,232	35,001
06/01/2018 06:00	34,674	374913,492	0,827	12,607	9451,441	35,003
06/01/2018 07:00	41,635	374976,248	0,795	12,679	9431,635	35
06/01/2018 08:00	37,955	371707,711	0,804	12,193	9410,74	34,999
06/01/2018 09:00	27,758	369740,083	0,598	12,607	9396,853	35,001
06/01/2018 10:00	28,105	369691,248	0,779	12,609	9387,262	34,999
06/01/2018 11:00	21,975	367767,457	0,756	12,689	9382,952	35
06/01/2018 12:00	17,133	368238,48	0,783	12,736	9374,41	34,998
06/01/2018 13:00	12,01	365378,145	0,78	12,936	9367,21	35,001
06/01/2018 14:00	9,896	363893,327	0,77	13,063	9351,41	34,999
06/01/2018 15:00	10,554	365868,446	0,786	12,806	9351,324	34,999
06/01/2018 16:00	10,43	365877,842	0,8	12,774	9320,214	35,002
06/01/2018 17:00	8,842	365692,53	0,771	12,997	9325,169	34,999
06/01/2018 18:00	10,515	367080,517	0,793	13,067	9330,833	35
06/01/2018 19:00	16,003	369018,555	0,802	13,329	9359,027	35,001
06/01/2018 20:00	20,482	370528,641	0,779	13,474	9399,067	34,998
06/01/2018 21:00	20,103	370920,731	0,788	13,434	9424,467	35
06/01/2018 22:00	20,681	371590,695	0,805	13,404	9430,752	35
06/01/2018 23:00	21,806	368616,302	0,793	13,204	9428,93	35,002
07/01/2018 00:00	20,079	372227,816	0,812	13,165	9432,509	35,002
07/01/2018 01:00	21,683	372322,119	0,828	13,112	9434,733	35
07/01/2018 02:00	39,321	358402,132	0,803	14,866	9068,288	32,989
07/01/2018 03:00	96,64	336777,641	0,851	18,429	8294,398	29,001
07/01/2018 04:00	110,336	337900,567	0,847	18,094	8289,437	29,001
07/01/2018 05:00	116,878	335506,864	0,805	18,034	8296,049	29
07/01/2018 06:00	123,452	338485,61	0,853	18,157	8298,67	29
07/01/2018 07:00	55,984	381073,772	0,826	19,658	9776,05	36,558
07/01/2018 08:00	2,398	426621,77	0,737	20,274	11407,976	44,949
07/01/2018 09:00	2,41	427179,788	0,559	18,927	11391,145	44,92
07/01/2018 10:00	2,144	427629,397	0,726	18,077	11394,688	45,002
07/01/2018 11:00	2,02	425963,506	0,69	17,45	11389,368	44,997
07/01/2018 12:00	1,952	427123,245	0,712	17,484	11383,483	45
07/01/2018 13:00	1,933	427505,899	0,715	17,9	11378,087	44,999
07/01/2018 14:00	1,927	426100,056	0,704	18,129	11372,864	45,001
07/01/2018 15:00	1,914	428773,233	0,712	18,013	11375,724	45
07/01/2018 16:00	1,928	428022,563	0,714	17,894	11314,629	44,865
07/01/2018 17:00	1,915	429281,068	0,695	17,938	11370,789	44,999
07/01/2018 18:00	3,026	418278,259	0,719	18,804	10974,278	43,012
07/01/2018 19:00	3,213	413395,332	0,722	19,887	10801,619	42
07/01/2018 20:00	2,098	413352,161	0,716	21,39	10825,82	41,999
07/01/2018 21:00	28,245	393509,689	0,743	19,936	10160,541	38,603
07/01/2018 22:00	104,023	343004,21	0,796	15,781	8487,001	29,997
07/01/2018 23:00	118,212	341705,12	0,777	15,646	8505,003	30,078
08/01/2018 00:00	2,636	414700,067	0,727	22,909	10842,456	41,923
08/01/2018 01:00	2,282	415311,326	0,722	23,413	10857,037	42
08/01/2018 02:00	2,257	414491,081	0,713	23,25	10857,884	42
08/01/2018 03:00	2,555	417041,412	0,728	22,973	10857,561	42
08/01/2018 04:00	2,648	417690,219	0,725	22,853	10852,732	42
08/01/2018 05:00	3,071	415076,61	0,678	22,566	10849,659	42,001
08/01/2018 06:00	164,178	375260,635	0,766	19,04	9487,122	34,735
08/01/2018 07:00	588,586	298059,759	0,855	15,425	7068,157	21,074
08/01/2018 08:00	579,34	296129,891	0,835	15,264	7006,716	21,001
08/01/2018 09:00	553,646	293513,845	0,653	15,193	6959,563	20,999
08/01/2018 10:00	522,935	291771,939	0,885	15,209	6921,168	21
08/01/2018 11:00	503,726	289682,101	0,875	15,241	6898,09	21
08/01/2018 12:00	479,315	288891,942	0,896	15,561	6869,894	21
08/01/2018 13:00	460,041	286265,13	0,906	15,819	6839,862	20,996
08/01/2018 14:00	450,005	286333,27	0,896	15,965	6819,561	20,997
08/01/2018 15:00	211,866	340261,991	0,859	16,477	8514,411	30,29
08/01/2018 16:00	304,076	303091,274	0,888	15,656	7347,609	23,969
08/01/2018 17:00	465,276	288141,011	0,893	15,649	6817,742	21
08/01/2018 18:00	478,083	289433,829	0,908	15,47	6839,912	20,998
08/01/2018 19:00	502,133	291814,026	0,9	15,295	6893,299	20,998
08/01/2018 20:00	522,584	293911,167	0,881	15,333	6932,169	21
08/01/2018 21:00	544,238	294647,018	0,899	15,25	6961,829	21,002
08/01/2018 22:00	556,855	294764,751	0,889	15,461	6978,744	20,999
08/01/2018 23:00	566,381	293328,731	0,879	15,257	6993,279	21,002
09/01/2018 00:00	569,198	296456,591	0,905	15,287	6993,985	21,001
09/01/2018 01:00	579,728	297135,766	0,905	15,31	7009,125	20,999
09/01/2018 02:00	522,484	307413,572	0,884	15,216	7344,103	22,881
09/01/2018 03:00	181,935	383359,125	0,837	19,845	9760,135	36,01
09/01/2018 04:00	55,821	409786,865	0,785	21,485	10613,589	40,693
09/01/2018 05:00	3,446	422701,07	0,726	22,943	11153,152	43,502
09/01/2018 06:00	2,855	424907,029	0,782	22,981	11150,259	43,5
09/01/2018 07:00	2,282	426418,744	0,778	20,787	11289,461	44,335
09/01/2018 08:00	2,067	425190,76	0,751	18,879	11433,081	44,987

09/01/2018 09:00	2,302	428439,238	0,566	19,132	11443,004	45
09/01/2018 10:00	2,071	428022,75	0,675	15,703	11404,354	44,984
09/01/2018 11:00	1,917	426507,183	0,714	14,086	11384,243	44,999
09/01/2018 12:00	1,891	427707,941	0,722	14,375	11376,081	45
09/01/2018 13:00	1,876	425906,913	0,724	15,642	11347,711	44,925
09/01/2018 14:00	1,913	416562,973	0,717	16,135	11199,144	44,159
09/01/2018 15:00	1,836	425024,685	0,74	15,787	11432,477	45,499
09/01/2018 16:00	1,822	426025,594	0,732	15,877	11431,75	45,54
09/01/2018 17:00	1,8	425913,855	0,716	16,301	11699,545	46,798
09/01/2018 18:00	1,821	426761,954	0,72	16,429	11651,148	46,329
09/01/2018 19:00	1,82	427741,136	0,721	15,537	11556,162	45,761
09/01/2018 20:00	41,474	424781,003	0,759	15,4	10565,211	40,526
09/01/2018 21:00		0		4,102	615,825	0,01
09/01/2018 22:00		0		0,022	0	-0,067
09/01/2018 23:00		0		0	0	-0,074
10/01/2018 00:00		0		0	0	-0,078
10/01/2018 01:00		0		0	0	-0,081
10/01/2018 02:00		0		0	0	-0,082
10/01/2018 03:00		0		0	0	-0,084
10/01/2018 04:00		0		0	0	-0,084
10/01/2018 05:00		0		0	0	-0,084
10/01/2018 06:00		0		0	0	-0,086
10/01/2018 07:00		0		0	0	-0,086
10/01/2018 08:00		0		0	0	-0,09
10/01/2018 09:00		0		0,002	0	-0,097
10/01/2018 10:00		0		0	0	-0,099
10/01/2018 11:00		0		0	0	-0,098
10/01/2018 12:00		0		0	0	-0,091
10/01/2018 13:00		0		0	0	-0,081
10/01/2018 14:00		0		0	0	-0,074
10/01/2018 15:00		0		0	0	-0,072
10/01/2018 16:00		0		0	111,6	-0,071
10/01/2018 17:00		0		0	0	-0,074
10/01/2018 18:00		0		0	0	-0,076
10/01/2018 19:00		0		0	0	-0,081
10/01/2018 20:00		0		0	0	-0,089
10/01/2018 21:00		0		0	0	-0,096
10/01/2018 22:00		0		0	191,907	-0,097
10/01/2018 23:00		0		0	0	-0,094
11/01/2018 00:00		0		0,13	1157,189	-0,054
11/01/2018 01:00	295,233	0	0,721	7,087	5726,931	13,394
11/01/2018 02:00	466,884	0	0,167	13,466	7394,124	23,379
11/01/2018 03:00	292,097	0	0,361	10,312	7647,801	25,002
11/01/2018 04:00	187,871	46054,739	0,794	7,154	7741,982	25,574
11/01/2018 05:00	69,483	0	1,185	2,158	7660,147	25,001
11/01/2018 06:00	361,096	61793,815	0,4	12,383	7663,113	25,001
11/01/2018 07:00	246,797	332787,02	0,763	14,265	9162,145	32,801
11/01/2018 08:00	554,962	297868,372	0,93	13,987	7013,199	20,998
11/01/2018 09:00	367,661	324093,75	0,704	14,555	7936,642	26,405
11/01/2018 10:00	7,698	411828,373	0,849	14,261	10936,977	42,501
11/01/2018 11:00	1,946	426040,032	0,82	14,331	11510,806	45,488
11/01/2018 12:00	1,911	428526,185	0,83	14,952	11500,918	45,498
11/01/2018 13:00	1,848	428521,953	0,833	15,169	11494,419	45,498
11/01/2018 14:00	2,645	405116,622	0,831	17,396	10573,663	40,926
11/01/2018 15:00	2,228	411367,713	0,848	15,653	10747,376	41,811
11/01/2018 16:00	1,92	430319,869	0,82	15,858	11504,54	45,617
11/01/2018 17:00	89,259	429612,954	0,831	14,933	10470,53	40,128
11/01/2018 18:00	304,792	311749,39	0,961	15,793	7436,79	24,5
11/01/2018 19:00	245,959	331602,111	0,947	15,498	8051,652	27,699
11/01/2018 20:00	16,889	386891,344	0,869	15,997	9951,366	37,372
11/01/2018 21:00	18,501	392966,754	0,88	17,129	10054,169	38
11/01/2018 22:00	23,12	393982,584	0,887	17,148	10055,205	37,999
11/01/2018 23:00	19,605	391082,374	0,875	17,765	10055,279	38
12/01/2018 00:00	16,127	392113,831	0,881	18,516	10059,689	38,001
12/01/2018 01:00	10,553	385481,7	0,895	16,611	9892,886	37,164
12/01/2018 02:00	12,075	383729,059	0,876	16,006	9823,725	36,845
12/01/2018 03:00	22,303	393161,232	0,886	18,502	10051,237	38
12/01/2018 04:00	25,624	394014,59	0,89	18,371	10054,193	38
12/01/2018 05:00	30,259		0,862	12,895	9352,641	34,438
12/01/2018 06:00	31,528	368830,914	0,907	12,281	9264,171	33,999
12/01/2018 07:00	39,867	369519,999	0,898	11,539	9257,991	34
12/01/2018 08:00	12,119	365320,959	0,883	12,518	9262,884	33,998
12/01/2018 09:00	6,022	363379,044	0,683	13,41	9261,943	34
12/01/2018 10:00	38,536	360846,527	0,909	12,386	9048,886	33,047
12/01/2018 11:00	20,654	358585,831	0,9	12,985	9020,1	33
12/01/2018 12:00	4,135	354728,042	0,912	14,149	9008,974	32,999
12/01/2018 13:00	4,644	354490,524	0,921	13,934	9008,025	33,001
12/01/2018 14:00	2,916	354080,222	0,891	14,758	9016,753	33,001
12/01/2018 15:00	7,704	359902,161	0,909	13,654	9198,323	33,946
12/01/2018 16:00	11,352	362248,078	0,918	12,532	9213,851	33,999
12/01/2018 17:00	4,878	360140,925	0,891	13,941	9235,221	34,001
12/01/2018 18:00	21,71	366197,695	0,912	11,228	9231,198	34,001
12/01/2018 19:00	23,662	367503,569	0,909	11,525	9245,422	34,001
12/01/2018 20:00	23,922	368081,137	0,91	11,785	9257,192	34,001
12/01/2018 21:00	26,973	367521,33	0,929	11,849	9268,193	34,001
12/01/2018 22:00	21,332	367104,593	0,938	12,387	9272,05	33,999
12/01/2018 23:00	20,169	365849,364	0,909	12,569	9270,257	33,999
13/01/2018 00:00	27,558	364742,985	0,926	12,698	9216,372	33,665
13/01/2018 01:00	525,884	304947,241	1	14,483	7162,868	22,081
13/01/2018 02:00	540,2	302967,927	1,007	14,097	7180,387	22
13/01/2018 03:00	545,315	304528,399	1,013	14,173	7184,535	22,001
13/01/2018 04:00	542,417	304310,711	1	14,353	7184,005	21,999
13/01/2018 05:00	542,449		0,953	14,287	7185,383	22
13/01/2018 06:00	531,554	304590,055	1,017	14,385	7172,637	21,998
13/01/2018 07:00	524,007	303617,242	1,02	14,263	7157,903	22,002
13/01/2018 08:00	511,413	302156,761	0,996	14,446	7141,044	21,999
13/01/2018 09:00	494,886	301522,539	0,783	14,291	7115,545	22
13/01/2018 10:00	193,314	346843,169	0,997	13,831	8586,393	30,222
13/01/2018 11:00	36,253	360118,604	0,947	12,83	9139,517	33,452
13/01/2018 12:00	12,338	372888,998	0,957	12,439	9482,199	35,322
13/01/2018 13:00	15,99	388651,553	0,941	18,288	10024,705	37,995
13/01/2018 14:00	3,615	400628,208	0,907	18,829	10395,29	40,001

13/01/2018 15:00	2,835	398922,97	0,92	19,934	10409,663	40
13/01/2018 16:00	4,228	402101,691	0,932	18,877	10395,425	40
13/01/2018 17:00	3,973	402257,158	0,914	18,945	10406,055	40,001
13/01/2018 18:00	3,554	402590,714	0,921	19,105	10417,046	40
13/01/2018 19:00	4,276	403781,202	0,914	19,053	10434,573	40,001
13/01/2018 20:00	4,501	404965,142	0,899	19,202	10445,488	40,001
13/01/2018 21:00	4,75	404787,119	0,924	19,334	10452,772	39,999
13/01/2018 22:00	22,334	393427,437	0,93	18,296	10082,683	38,086
13/01/2018 23:00	102,543	344263,749	0,986	14,918	8503,694	30
14/01/2018 00:00	94,495	351335,143	1,009	14,69	8674,858	30,859
14/01/2018 01:00	22,056	389466,846	0,95	15,769	10066,223	37,958
14/01/2018 02:00	499,939	304886,899	1,052	14,42	7206,699	22,463
14/01/2018 03:00	32,279	394214,819	0,967	18,887	10055,568	38,119
14/01/2018 04:00	5,541	420141,707	0,935	20,898	10888,635	42,152
14/01/2018 05:00	4,143		0,874	21,282	11058,486	43
14/01/2018 06:00	3,077	426561,091	0,931	21,214	11058,605	43,001
14/01/2018 07:00	2,375	425463,538	0,92	20,403	11043,153	43
14/01/2018 08:00	2,169	421787,254	0,897	19,311	11048,43	43,001
14/01/2018 09:00	3,06	422302,253	0,671	19,483	11032,534	43,001
14/01/2018 10:00	2,162	419174,522	0,849	19,348	11043,02	43
14/01/2018 11:00	2,145	418443,744	0,835	19,207	10920,472	42,376
14/01/2018 12:00	2,16	410659,534	0,86	18,73	10819,575	41,945
14/01/2018 13:00	2,381	419419,445	0,857	18,994	11017,859	43
14/01/2018 14:00	2,386	421148,757	0,852	17,617	10997,06	43,001
14/01/2018 15:00	2,281	420970,202	0,868	17,273	10990,28	42,999
14/01/2018 16:00	2,29	421724,382	0,862	17,835	10985,354	42,999
14/01/2018 17:00	2,529	422861,773	0,842	19,569	10988,678	43
14/01/2018 18:00	2,794	424763,728	0,864	19,731	11005,323	43,002
14/01/2018 19:00	3,174	426386,901	0,863	20,04	11045,662	43,001
14/01/2018 20:00	2,962	426586,947	0,866	21,448	11063,736	42,998
14/01/2018 21:00	2,661	424157,952	0,893	21,922	11071,4	43,001
14/01/2018 22:00	2,11	423935,199	0,875	22,144	11073,685	43
14/01/2018 23:00	2,16	423733,686	0,869	22,402	11071,016	43
15/01/2018 00:00	2,222	426310,854	0,878	22,218	11065,596	43,002
15/01/2018 01:00	2,276	426550,301	0,895	22,132	11069,865	42,998
15/01/2018 02:00	2,29	426557,557	0,878	22,107	11064,385	43
15/01/2018 03:00	2,337	426483,754	0,902	22,052	11062,438	43,001
15/01/2018 04:00	2,314	426499,587	0,907	22,073	11063,689	42,998
15/01/2018 05:00	2,282		0,856	21,674	11247,275	43,903
15/01/2018 06:00	2,024	429043,933	0,886	20,615	11677,316	46,001
15/01/2018 07:00	2,064	429123,94	0,912	20,81	11679,602	46
15/01/2018 08:00	2,106	428684,893	0,857	20,312	11678,518	46,002
15/01/2018 09:00	2,288	427812,952	0,694	19,696	11678,89	46
15/01/2018 10:00	2,102	427879,439	0,907	19,618	11674,317	46
15/01/2018 11:00	2,068	427853,992	0,899	18,892	11658,259	46,002
15/01/2018 12:00	2,04	427826,27	0,914	18,461	11638,838	45,997
15/01/2018 13:00	1,984	428328,795	0,921	17,494	11626,345	45,959
15/01/2018 14:00	1,878	429077,54	0,904	16,154	11603,187	45,988
15/01/2018 15:00	1,872	428266,815	0,923	15,687	11607,088	46
15/01/2018 16:00	1,859	428422,258	0,911	15,584	11602,092	46,001
15/01/2018 17:00	1,853	428617,174	0,896	15,498	11611,39	45,999
15/01/2018 18:00	1,844	429048,792	0,904	15,408	11625,176	45,999
15/01/2018 19:00	1,849	428900,442	0,913	15,362	11645,635	46
15/01/2018 20:00	1,882	428964,772	0,893	15,296	11658,877	45,999
15/01/2018 21:00	1,918	427999,536	0,92	15,51	11668,617	46,002
15/01/2018 22:00	1,907	428197,557	0,918	16,476	11672,904	46
15/01/2018 23:00	1,942	426984,544	0,91	16,694	11671,136	45,998
16/01/2018 00:00	2,01	428674,37	0,934	17,427	11672,66	45,999
16/01/2018 01:00	2,256	428878,936	0,949	18,565	11669,464	46,001
16/01/2018 02:00	2,557	428561,051	0,915	19,468	11661,535	45,999
16/01/2018 03:00	2,71	428773,697	0,921	19,538	11658,835	46
16/01/2018 04:00	2,477	429068,309	0,93	19,33	11664,246	46,001
16/01/2018 05:00	3,093		0,889	19,66	11661,954	45,999
16/01/2018 06:00	4,554	428396,637	0,941	19,645	11655,116	46
16/01/2018 07:00	3,164	428235,653	0,918	19,558	11660,389	46
16/01/2018 08:00	3,128	428235,446	0,919	17,291	11652,955	46
16/01/2018 09:00	2,528	425830,84	0,693	15,963	11637,006	46
16/01/2018 10:00	2,049	426409,486	0,884	14,668	11625,16	45,998
16/01/2018 11:00	1,94	426463,059	0,866	16,686	11625,775	46
16/01/2018 12:00	1,916	427659,764	0,874	16,859	11615,241	45,988
16/01/2018 13:00	1,908	427971,453	0,882	17,239	11539,545	45,676
16/01/2018 14:00	1,885	427730,095	0,869	16,868	11646,651	46,344
16/01/2018 15:00	1,846	427684,717	0,893	16,749	11748,728	46,996
16/01/2018 16:00	1,835	428200,372	0,887	16,727	11746,178	46,999
16/01/2018 17:00	1,825	428147,505	0,853	16,908	11767,205	47
16/01/2018 18:00	2,4	428009,396	0,881	16,115	11517,643	45,642
16/01/2018 19:00	1,837	428199,319	0,869	15,734	11700,728	46,426
16/01/2018 20:00	1,854	427978,338	0,864	15,923	11748,213	46,501
16/01/2018 21:00	1,868	423603,919	0,895	15,869	11760,251	46,5
16/01/2018 22:00	1,916	424325,734	0,903	15,782	11763,946	46,5
16/01/2018 23:00	1,933	424942,981	0,879	15,799	11763,135	46,502
17/01/2018 00:00	1,936	427668,055	0,905	15,775	11767,18	46,5
17/01/2018 01:00	2,004	427721,452	0,91	15,894	11769,387	46,5
17/01/2018 02:00	2,15	426401,061	0,901	16,866	11762,678	46,501
17/01/2018 03:00	2,202	426080,652	0,932	17,344	11764,041	46,5
17/01/2018 04:00	2,091	426452,449	0,929	18,26	11760,699	46,5
17/01/2018 05:00	2,147		0,858	17,754	11758,234	46,5
17/01/2018 06:00	2,539	427876,35	0,917	17,751	11758,22	46,501
17/01/2018 07:00	3,279	428101,335	0,895	15,445	11752,037	46,502
17/01/2018 08:00	2,036	428052,949	0,887	14,327	11739,271	46,5
17/01/2018 09:00	2,188	427616,82	0,654	15,343	11722,064	46,494
17/01/2018 10:00	1,995	427759,745	0,83	15,106	11710,006	46,498
17/01/2018 11:00	1,903	427474,188	0,804	16,628	11829,158	47,102
17/01/2018 12:00	1,89	428042,748	0,833	16,801	11779,352	46,916
17/01/2018 13:00	1,847	428567,224	0,827	16,714	11845,848	47,3
17/01/2018 14:00	1,845	428491,775	0,814	16,708	11829,619	47,293
17/01/2018 15:00	1,83	428764,015	0,828	16,645	11782,619	47,267
17/01/2018 16:00	1,833	428634,623	0,828	16,878	11747,746	47,195
17/01/2018 17:00	1,841	428139,052	0,814	16,833	11759,421	47,182
17/01/2018 18:00	1,84	429294,84	0,816	16,944	11819,609	47,3
17/01/2018 19:00	1,87	429438,762	0,816	17,175	11856,662	47,301
17/01/2018 20:00	1,868	429480,484	0,8	17,188	11896,486	47,298

17/01/2018 21:00	1,895	429369,75	0,824	17,199	11909,696	47,302
17/01/2018 22:00	1,938	428811,42	0,83	17,337	11915,688	47,298
17/01/2018 23:00	2	426782,135	0,823	17,275	11917,163	47,301
18/01/2018 00:00	1,935	428391,523	0,847	16,987	11915,18	47,3
18/01/2018 01:00	1,983	428406,639	0,856	17,567	11921,761	47,275
18/01/2018 02:00	1,888	428767,949	0,841	17,62	11929,401	47,301
18/01/2018 03:00	45,441	399398,559	0,89	17,176	10662,472	40,898
18/01/2018 04:00	449,331	310101,5	0,993	16,157	7379,487	23,144
18/01/2018 05:00	565,153		0,957	15,956	7005,338	21,002
18/01/2018 06:00	562,431	298875,37	1,014	16,096	7004,549	21
18/01/2018 07:00	541,928	297387,727	1,02	16,236	6978,99	21,001
18/01/2018 08:00	525,544	296371,447	0,997	16,053	6949,511	21
18/01/2018 09:00	494,567	292490,464	0,748	16,231	6906,002	21
18/01/2018 10:00	466,183	290242,691	1,005	16,538	6871,105	21
18/01/2018 11:00	446,595	289544,711	0,997	16,729	6841,312	21
18/01/2018 12:00	421,593	286778,149	1,021	17,252	6824,802	21
18/01/2018 13:00	404,564	284562,97	1,019	17,718	6805,051	20,999
18/01/2018 14:00	391,489	283965,894	1,009	18,168	6782,82	21,001
18/01/2018 15:00	386,35	284721,09	1,029	18,375	6760,077	21
18/01/2018 16:00	384,385	285374,219	1,018	18,149	6751,71	20,999
18/01/2018 17:00	399,834	286567,686	1,003	17,569	6770,649	21
18/01/2018 18:00	426,026	288203,192	1,025	16,744	6794,638	21
18/01/2018 19:00	446,122	293607,169	1,012	16,54	6899,35	21,346
18/01/2018 20:00	192,494	338468,49	0,949	16,733	8472,605	29,598
18/01/2018 21:00	39,563	363964,232	0,927	15,695	9223,602	33,829
18/01/2018 22:00	279,024	339078,833	0,959	17,327	8322,373	28,643
18/01/2018 23:00	154,864	377446,317	0,913	19,72	9715,884	36,027
19/01/2018 00:00	2,298	415769,358	0,885	21,294	10862,599	42
19/01/2018 01:00	2,244	416049,376	0,887	22,064	10870,426	42,001
19/01/2018 02:00	2,218	414490,148	0,862	21,398	10874,533	42,001
19/01/2018 03:00	2,259	416100,424	0,878	21,34	10914,7	42,199
19/01/2018 04:00	2,155	415609,507	0,883	20,779	10915,865	42,2
19/01/2018 05:00	2,205		0,821	20,89	10951,357	42,413
19/01/2018 06:00	2,291	420400,035	0,892	21,997	10995,069	42,668
19/01/2018 07:00	2,239	422480,814	0,884	22,614	11070,183	43,001
19/01/2018 08:00	62,11	378198,392	0,91	19,301	9552,237	35,138
19/01/2018 09:00	236,987	316599,936	0,707	17,892	7680,461	25,742
19/01/2018 10:00	344,479	300753,098	0,935	17,771	7182,088	23,125
19/01/2018 11:00	176,442	318924,543	0,891	17,717	7801,964	26,547
19/01/2018 12:00	75,346	324780,414	0,891	19,134	8037,271	28,001
19/01/2018 13:00	77,896	323981,9	0,899	18,686	8038,471	28
19/01/2018 14:00	93,504	324231,475	0,89	18,582	7950,445	27,606
19/01/2018 15:00	170,706	314466,124	0,922	18,444	7648,841	26,001
19/01/2018 16:00	176,848	315738,515	0,924	18,157	7652,884	26,002
19/01/2018 17:00	182,36	315505,061	0,908	18,129	7651,17	26
19/01/2018 18:00	220,947	343944,325	0,911	16,537	8713,522	31,033
19/01/2018 19:00	2,395	412396,278	0,82	18,165	10754,097	41,903
19/01/2018 20:00	2,046	420934,019	0,788	17,718	11023,187	42,999
19/01/2018 21:00	2,087	422027,635	0,81	18,254	11040,995	42,999
19/01/2018 22:00	2,776	414963,811	0,824	19,426	10794,107	41,73
19/01/2018 23:00	2,322	415854,442	0,799	19,537	10843,103	42
20/01/2018 00:00	2,466	416687,954	0,826	20,306	10844,116	42
20/01/2018 01:00	2,371	416979,236	0,816	21,698	10844,946	42
20/01/2018 02:00	2,362	416343,84	0,798	21,702	10842,47	42
20/01/2018 03:00	2,531	416636,992	0,832	21,434	10843,158	42
20/01/2018 04:00	194,251	342356,186	0,903	15,191	8356,296	29,145
20/01/2018 05:00	370,166		0,851	16,254	8668,086	29,837
20/01/2018 06:00	132,868	387549,043	0,859	18,04	9849,875	36,574
20/01/2018 07:00	420,497	318985,365	0,929	14,994	7645,239	24,776
20/01/2018 08:00	517,936	303281,658	0,925	14,554	7142,012	21,997
20/01/2018 09:00	523,043	300898,066	0,729	14,537	7142,317	22,001
20/01/2018 10:00	356,208	324581,71	0,979	14,84	7963,739	26,798
20/01/2018 11:00	201,735	335491,472	0,954	15,257	8039,528	27,778
20/01/2018 12:00	307,139	313945,513	1,003	15,804	7539,864	24,999
20/01/2018 13:00	36,691	391290,175	0,915	17,815	10093,595	38,391
20/01/2018 14:00	3,225	412715,461	0,862	19,043	10804,759	42,002
20/01/2018 15:00	3,114	412329,598	0,892	18,733	10789,47	42,001
20/01/2018 16:00	2,949	413554,105	0,893	18,871	10774,139	42
20/01/2018 17:00	2,927	413434,944	0,869	18,841	10769,694	42
20/01/2018 18:00	2,806	412838,876	0,888	19,067	10784,224	42,001
20/01/2018 19:00	3,335	415476,338	0,881	19,671	10817,481	41,998
20/01/2018 20:00	2,195	414116,795	0,864	18,649	10819,613	41,998
20/01/2018 21:00	2,206	415483,998	0,892	19,49	10820,301	41,998
20/01/2018 22:00	406,204	316262,266	1,001	14,981	7601,879	24,488
20/01/2018 23:00	524,818	302705,066	1,003	14,49	7131,41	22
21/01/2018 00:00	543,056	303166,524	1,038	14,411	7151,025	22,001
21/01/2018 01:00	559,486	303646,802	1,044	14,477	7163,093	22,002
21/01/2018 02:00	566,835	303551,229	1,028	14,478	7166,465	22
21/01/2018 03:00	357,863	332746,234	1,019	14,461	8054,523	27,209
21/01/2018 04:00	28,303	404639,464	0,908	18,782	10339,507	39,595
21/01/2018 05:00	3,368		0,842	21,114	10780,142	41,999
21/01/2018 06:00	3,089	420530,285	0,901	21,3	10779,66	42
21/01/2018 07:00	3,163	420016,692	0,908	21,169	10766,223	41,998
21/01/2018 08:00	3,644	419575,604	0,868	20,46	10745,374	42
21/01/2018 09:00	2,989	416825,82	0,661	19,894	10723,843	42,001
21/01/2018 10:00	2,469	415675,156	0,86	19,628	10711,994	41,997
21/01/2018 11:00	2,351	414766,053	0,832	19,444	10685,756	42,001
21/01/2018 12:00	2,288	414729,926	0,86	19,79	10685,547	41,997
21/01/2018 13:00	2,144	412574,064	0,854	19,717	10674,604	42,001
21/01/2018 14:00	2,069	412213,863	0,834	18,431	10602,601	42
21/01/2018 15:00	2,054	412265,724	0,855	17,94	10592,786	42
21/01/2018 16:00	2,055	412109,115	0,857	17,659	10588,637	42
21/01/2018 17:00	2,043	412478,615	0,835	17,578	10597,947	42,001
21/01/2018 18:00	2,057	414138,947	0,848	18,366	10612,327	42,001
21/01/2018 19:00	14,043	396997,403	0,882	18,066	10014,794	38,803
21/01/2018 20:00	12,297	392372,214	0,873	19,206	9871,878	38
21/01/2018 21:00	14,912	393150,363	0,887	19,335	9877,696	38
21/01/2018 22:00	19,779	397588,26	0,893	19,364	9977,942	38,567
21/01/2018 23:00	24,814	394284,674	0,9	18,692	9858,187	38
22/01/2018 00:00	26,721	393564,72	0,902	18,636	9856,527	37,999
22/01/2018 01:00	24,118	393972,395	0,905	18,939	9834,266	38
22/01/2018 02:00	28,326	393701,364	0,898	18,555	9834,11	38,001

22/01/2018 03:00	4,271	390177,439	0,91	16,193	9869,231	37,998
22/01/2018 04:00	2,422	389814,716	0,916	16,034	9872,318	38,001
22/01/2018 05:00	2,366		0,861	16,037	9868,675	37,998
22/01/2018 06:00	2,471	392277,72	0,902	15,99	9875,937	38
22/01/2018 07:00	2,616	392208,28	0,901	15,263	9874,073	38
22/01/2018 08:00	2,529	391356,541	0,891	14,608	9876,084	38
22/01/2018 09:00	2,589	388939,367	0,663	14,787	9877,994	37,999
22/01/2018 10:00	11,378	389313,015	0,852	16,923	9849,455	38,001
22/01/2018 11:00	3,859	411042,464	0,809	19,204	10603,42	41,754
22/01/2018 12:00	2,144	420534,729	0,817	19,543	10817,593	42,919
22/01/2018 13:00	2,125	420259,129	0,814	19,341	10852,726	42,999
22/01/2018 14:00	2,123	421130,401	0,81	18,308	10845,828	43
22/01/2018 15:00	2,13	419620,949	0,83	18,292	10818,693	43,002
22/01/2018 16:00	2,105	419902,408	0,828	18,52	10816,126	43
22/01/2018 17:00	2,101	419951,043	0,806	18,282	10839,157	43
22/01/2018 18:00	2,148	421373,314	0,818	18,651	10846,579	42,999
22/01/2018 19:00	2,272	423289,006	0,82	20,109	10874,795	43,001
22/01/2018 20:00	2,336	424676,816	0,806	21,312	10899,718	43,001
22/01/2018 21:00	2,426	424813,231	0,834	21,306	10914,279	43
22/01/2018 22:00	2,513	424996,337	0,836	21,345	10917,692	42,999
22/01/2018 23:00	2,636	425915,688	0,83	21,373	10913,559	42,999
23/01/2018 00:00	2,645	426028,916	0,848	22,114	10916,056	43,001
23/01/2018 01:00	2,657	426517,252	0,84	23,049	10913,34	42,999
23/01/2018 02:00	2,548	425867,707	0,823	22,834	10924,037	43
23/01/2018 03:00	2,633	426618,315	0,841	22,573	10922,419	43,001
23/01/2018 04:00	2,381	425971,127	0,849	22,827	10908,095	43
23/01/2018 05:00	2,333		0,792	23,054	10902,119	43
23/01/2018 06:00	2,493	425655,194	0,846	22,895	10906,131	43
23/01/2018 07:00	2,793	426549,371	0,84	21,034	10895,53	43,001
23/01/2018 08:00	2,3	425822,081	0,821	20,782	10885,296	42,998
23/01/2018 09:00	2,387	422092,594	0,634	20,145	10874,618	43,004
23/01/2018 10:00	2,088	420402,363	0,855	18,781	10873,916	42,998
23/01/2018 11:00	2,146	420205,649	0,832	18,164	10865,457	42,998
23/01/2018 12:00	2,118	416034,083	0,866	17,452	10854,546	42,968
23/01/2018 13:00	2,186	417480,61	0,863	18,606	10862,847	43,001
23/01/2018 14:00	2,171	417097,175	0,852	19,202	10845,75	42,988
23/01/2018 15:00	2,324	419737,638	0,873	20,674	10821,175	43
23/01/2018 16:00	2,368	421099,194	0,869	21,203	10809,804	43
23/01/2018 17:00	2,482	421918,657	0,861	21,118	10810,866	43
23/01/2018 18:00	2,313	419303,544	0,881	21,43	10828,297	43
23/01/2018 19:00	2,352	420568,324	0,875	21,276	10861,502	42,998
23/01/2018 20:00	2,306	421604,034	0,855	20,85	10897,843	43,002
23/01/2018 21:00	2,351	423994,044	0,875	21,602	10913,197	43,001
23/01/2018 22:00	2,422	424881,326	0,889	21,625	10915,733	42,999
23/01/2018 23:00	21,279	395702,31	0,891	18,796	10521,324	40,803
24/01/2018 00:00	28,291	393278,848	0,934	18,058	9895,678	37,93
24/01/2018 01:00	29,055	394070,341	0,928	18,104	9904,84	37,998
24/01/2018 02:00	4,014	388630,891	0,904	15,844	9873,225	37,727
24/01/2018 03:00	7,706	379861,144	0,94	14,114	9538,703	36
24/01/2018 04:00	8,922	380687,548	0,948	13,968	9537,858	36,001
24/01/2018 05:00	9,416		0,882	13,728	9532,899	35,999
24/01/2018 06:00	11,418	381037,711	0,939	13,688	9537,708	35,998
24/01/2018 07:00	2,512	377725,626	0,928	16,194	9554,639	36
24/01/2018 08:00	3,13	376014,938	0,909	16,039	9542,331	36
24/01/2018 09:00	5,966	374325,891	0,702	15,108	9513,432	36
24/01/2018 10:00	2,223	414572,849	0,856	18,732	10710,6	42,226
24/01/2018 11:00	2,149	426706,97	0,828	18,279	11051,701	44
24/01/2018 12:00	2,103	415261,222	0,843	18,096	10893,449	43,099
24/01/2018 13:00	2,415	409740,87	0,851	19,088	10804,571	42,691
24/01/2018 14:00	416,879	280662,993	1,011	17,828	6728,834	21,063
24/01/2018 15:00	408,408	286895,644	1,027	18,179	6766,545	21,4
24/01/2018 16:00	102,587	322202,385	0,971	18,939	7937,327	27,892
24/01/2018 17:00	202,513	316417,948	0,972	18,823	7433,698	25,23
24/01/2018 18:00	253,088	305507,378	1,011	19,183	7252,648	24,227
24/01/2018 19:00	195,162	316119,412	0,992	19,064	7535,417	25,695
24/01/2018 20:00	495,771	291101,674	0,988	15,637	6800,847	21
24/01/2018 21:00	252,671	329368,115	0,988	16,187	7941,602	27,244
24/01/2018 22:00	2,077	428098,346	0,849	18,438	11889,548	47,976
24/01/2018 23:00	2,039	426651,363	0,834	18,695	11717,382	47,003
25/01/2018 00:00	2,159	423580,753	0,868	20,524	10903,86	43,002
25/01/2018 01:00	2,145	423489,546	0,855	21,062	10910,268	43
25/01/2018 02:00	2,122	422306,709	0,861	20,993	10916,056	43
25/01/2018 03:00	2,133	422702,842	0,895	22,183	10914,956	43
25/01/2018 04:00	2,359	425647,068	0,891	22,642	10898,342	42,999
25/01/2018 05:00	152,21		0,886	20,753	9784,797	36,899
25/01/2018 06:00	2,999	426891,746	0,903	22,919	10891,135	42,999
25/01/2018 07:00	2,698	426002,305	0,888	21,332	10894,071	43
25/01/2018 08:00	2,185	422323,028	0,861	20,61	10905,741	42,999
25/01/2018 09:00	2,522	418947,326	0,781	21,446	10902,327	43,002
25/01/2018 10:00	2,17	418600,308	0,831	21,305	10901,05	43
25/01/2018 11:00	2,189	417568,788	0,816	20,691	10901,031	43,001
25/01/2018 12:00	2,194	413452,345	0,845	20,844	10895,601	43
25/01/2018 13:00	2,129	413306,404	0,848	19,831	10875,549	43
25/01/2018 14:00	306,069	310259,506	0,977	17,832	7383,194	24,602
25/01/2018 15:00	361,45	292297,172	1,014	17,439	6860,768	21,999
25/01/2018 16:00	315,91	298983,048	0,997	17,257	7054,231	23,09
25/01/2018 17:00	102,578	361638,417	0,906	19,349	9282,588	35,062
25/01/2018 18:00	2,352	422078,241	0,867	20,87	10867,919	43,177
25/01/2018 19:00	2,195	425327,504	0,859	20,602	10962,62	43,502
25/01/2018 20:00	2,281	422788,741	0,852	22,002	10994,851	43,5
25/01/2018 21:00	2,46	427885,832	0,86	22,269	11002,792	43,499
25/01/2018 22:00	2,603	427422,602	0,856	22,436	11010,809	43,501
25/01/2018 23:00	2,828	427839,658	0,839	22,325	11013,105	43,499
26/01/2018 00:00	2,918	427882,955	0,867	22,388	11012,959	43,501
26/01/2018 01:00	2,42	427584,303	0,856	22,57	11012,109	43,5
26/01/2018 02:00	2,188	426554,73	0,844	22,813	11009,623	43,501
26/01/2018 03:00	2,25	426630,855	0,868	24,115	11007,37	43,498
26/01/2018 04:00	2,324	427365,431	0,863	24,495	11007,174	43,5
26/01/2018 05:00	2,384		0,82	24,47	11002,308	43,499
26/01/2018 06:00	2,42	427608,207	0,867	23,96	10999,502	43,499
26/01/2018 07:00	2,985	425434,825	0,81	22,229	10887,848	42,938
26/01/2018 08:00	2,448	427188,875	0,85	21,646	10961,408	43,421

26/01/2018 09:00	2,123	422917,837	0,797	19,445	10990,516	43,5
26/01/2018 10:00	2,173	423013,835	0,819	21,775	10994,094	43,499
26/01/2018 11:00		421954,146	0,755	20,534	10998,889	43,499
26/01/2018 12:00	2,083	420131,169	0,822	19,292	10994,322	43,499
26/01/2018 13:00	1,998	419721,259	0,823	17,26	10961,868	43,499
26/01/2018 14:00	2,005	419294,585	0,817	17,218	10955,838	43,5
26/01/2018 15:00	2,02	419251,404	0,829	17,712	10940,523	43,5
26/01/2018 16:00	2,021	419993,998	0,832	18,249	10936,955	43,502
26/01/2018 17:00	2,008	420583,031	0,811	18,039	10933,976	43,501
26/01/2018 18:00	2,043	422101,125	0,822	19,036	10955,636	43,501
26/01/2018 19:00	2,074	422917,128	0,822	19,867	11003,379	43,5
26/01/2018 20:00	2,076	420824,917	0,807	20,345	11029,97	43,502
26/01/2018 21:00	2,143	425023,031	0,838	21,08	11034,996	43,501
26/01/2018 22:00	2,266	426265,713	0,858	21,305	11054,806	43,635
26/01/2018 23:00	2,796	428062,219	0,843	21,012	11025,622	43,501
27/01/2018 00:00	2,953	428419,14	0,86	20,861	11025,432	43,502
27/01/2018 01:00	2,849	428175,891	0,863	20,808	11025,096	43,499
27/01/2018 02:00	2,198	426824,432	0,83	20,958	11033,989	43,624
27/01/2018 03:00	2,204	427488,076	0,863	20,534	11117,246	43,999
27/01/2018 04:00	2,423	425211,372	0,874	21,009	11039,275	43,492
27/01/2018 05:00	2,502		0,83	20,866	10885,476	42,887
27/01/2018 06:00	2,516	425947,167	0,868	20,789	10915,512	43
27/01/2018 07:00	2,86	424534,523	0,704	20,245	10910,353	43,001
27/01/2018 08:00	2,204	422513,567	0,832	19,424	10914,455	42,998
27/01/2018 09:00	2,136	419299,407	0,839	19,582	10909,645	43,002
27/01/2018 10:00	2,172	418089,62	0,821	20,074	10912,46	43,001
27/01/2018 11:00	2,139	417081,637	0,818	19,651	10855,181	42,773
27/01/2018 12:00	2,054	417267,715	0,839	17,952	10836,216	42,875
27/01/2018 13:00	2,014	416525,19	0,84	18,04	10845,091	43
27/01/2018 14:00	2,329	416721,608	0,826	19,993	10793,4	42,917
27/01/2018 15:00	2,524	421831,73	0,852	20,097	10795,516	43
27/01/2018 16:00	2,453	421423,393	0,847	20,078	10781,723	42,995
27/01/2018 17:00	2,396	416846,584	0,829	20,168	10766,38	42,877
27/01/2018 18:00	2,278	421539,137	0,837	19,998	10807,495	42,997
27/01/2018 19:00	2,283	420535,412	0,837	19,807	10843,283	42,962
27/01/2018 20:00	2,398	417327,641	0,832	19,811	10899,07	43
27/01/2018 21:00	2,819	424742,671	0,86	20,707	10892,782	43
27/01/2018 22:00	2,235	423623,355	0,855	21,445	10895,285	42,999
27/01/2018 23:00	2,219	423718,204	0,846	21,532	10895,8	42,975
28/01/2018 00:00	9,566	408015,575	0,885	19,282	10411,549	40,533
28/01/2018 01:00	265,397	320767,116	0,992	16,769	7554,856	25,6
28/01/2018 02:00	273,985	321140,25	0,977	16,363	7577,934	25,602
28/01/2018 03:00	279,48	321068,205	1,006	16,296	7578,67	25,599
28/01/2018 04:00	294,612	321979,507	0,997	16,185	7587,626	25,599
28/01/2018 05:00	295,611		0,95	16,153	7591,216	25,599
28/01/2018 06:00	305,623	322174,909	1,016	16,178	7599,82	25,601
28/01/2018 07:00	280,635	321657,944	0,806	16,785	7581,123	25,6
28/01/2018 08:00	259,434	320842,948	0,965	16,876	7562,309	25,6
28/01/2018 09:00	219,683	314581,816	0,981	17,564	7524,822	25,599
28/01/2018 10:00	100,844	356391,965	0,945	19,216	8872,269	32,716
28/01/2018 11:00	2,117	417684,457	0,849	19,371	10817,23	42,959
28/01/2018 12:00	2,041	415936,685	0,868	18,258	10810,935	42,999
28/01/2018 13:00	2,215	414468,374	0,867	18,885	10766,333	42,867
28/01/2018 14:00	2,28	416960,181	0,854	19,705	10793,785	43
28/01/2018 15:00	2,188	417088,961	0,879	19,243	10781,722	43
28/01/2018 16:00	2,157	417483,406	0,872	19,08	10771,02	43
28/01/2018 17:00	2,147	415013,12	0,855	18,587	10771,968	43,001
28/01/2018 18:00	2,217	419642,846	0,875	19,521	10784,788	42,986
28/01/2018 19:00	2,384	421065,124	0,865	19,999	10826,081	42,997
28/01/2018 20:00	2,443	418740,882	0,862	20,043	10859,812	43,001
28/01/2018 21:00	2,498	424128,678	0,878	20,132	10875,758	42,998
28/01/2018 22:00	2,63	424800,473	0,885	20,035	10884,694	43
28/01/2018 23:00	2,878	425484,429	0,867	20,016	10884,57	43,001
29/01/2018 00:00	2,843	426135,603	0,886	20,008	10889,125	42,999
29/01/2018 01:00	2,667	425125,317	0,885	19,908	10893,946	43,001
29/01/2018 02:00	2,227	423972,331	0,874	20,572	10893,246	43,001
29/01/2018 03:00	2,297	423596,444	0,884	20,593	10893,907	43
29/01/2018 04:00	2,304	423968,884	0,896	21,413	10892,306	42,999
29/01/2018 05:00	2,242		0,844	21,605	10886,349	42,999
29/01/2018 06:00	2,427	425586,509	0,89	21,324	10884,836	43
29/01/2018 07:00	2,337	427826,787	0,718	18,162	12047,507	48,811
29/01/2018 08:00	1,972	428652,66	0,834	17,756	12288,386	50,001
29/01/2018 09:00	1,948	428505,038	0,852	17,533	12184,888	49,536
29/01/2018 10:00	1,906	428433,737	0,814	17,275	12242,741	49,934
29/01/2018 11:00	1,937	428135,576	0,799	17,115	12218,92	49,895
29/01/2018 12:00	1,911	427901,917	0,821	16,645	12237,636	49,997
29/01/2018 13:00	1,861	429038,788	0,816	16,455	12211,274	49,95
29/01/2018 14:00	1,894	428748,676	0,815	16,9	11875,169	48,236
29/01/2018 15:00	1,971	429381,927	0,844	16,814	11199,788	44,998
29/01/2018 16:00	1,975	430363,383	0,847	16,809	11199,299	45,001
29/01/2018 17:00	1,983	426776,862	0,833	17,053	11201,271	44,998
29/01/2018 18:00	2,001	429613,198	0,837	17,58	11222,301	44,999
29/01/2018 19:00	2,037	429382,721	0,829	18,629	11257,071	45,001
29/01/2018 20:00	2,051	425602,131	0,808	18,813	11292,668	45,001
29/01/2018 21:00	2,13	428734,198	0,843	22,06	11301,205	45
29/01/2018 22:00	2,226	426479,958	0,847	21,767	11080,009	43,765
29/01/2018 23:00	2,381	426076,45	0,849	21,59	10904,816	43,002
30/01/2018 00:00	2,536	426695,381	0,871	21,704	10902,036	42,998
30/01/2018 01:00	2,447	426339,14	0,874	21,771	10912,486	42,999
30/01/2018 02:00	2,432	426413,731	0,859	21,703	10914,64	43
30/01/2018 03:00	2,53	426495,344	0,873	21,78	10920,109	43
30/01/2018 04:00	2,332	426461,277	0,869	22,554	10924,812	43
30/01/2018 05:00	2,462		0,819	22,486	10927,452	43,001
30/01/2018 06:00	2,402	425973,733	0,876	22,343	10934,269	43
30/01/2018 07:00	323,387	337997,38	0,792	15,31	8097,954	27,898
30/01/2018 08:00	72,682	393326,117	0,883	18,37	10246,883	39,725
30/01/2018 09:00	2,039	428852,984	0,846	17,792	12143,642	49,42
30/01/2018 10:00	1,93	428772,426	0,835	17,381	12263,931	49,938
30/01/2018 11:00	1,921	427438,784	0,829	17,437	12273,852	50,001
30/01/2018 12:00	1,907	427280,836	0,845	16,299	12269,131	49,944
30/01/2018 13:00	1,859	427864,728	0,863	15,899	11988,401	48,793
30/01/2018 14:00	1,997	425987,57	0,842	16,127	11709,322	47,706

30/01/2018 15:00	1,849	428092,597	0,856	15,452	12149,436	49,599
30/01/2018 16:00	1,868	428727,579	0,852	15,99	11814,574	48,112
30/01/2018 17:00	1,877	425166,393	0,84	15,712	11633,272	47,184
30/01/2018 18:00	1,905	428953,154	0,863	15,295	11392,821	46
30/01/2018 19:00	1,911	428856,695	0,868	15,075	11428,66	46,001
30/01/2018 20:00	1,97	425462,799	0,847	14,989	11470,677	45,998
30/01/2018 21:00	1,988	428237,675	0,874	14,789	11486,982	46
30/01/2018 22:00	1,991	428293,401	0,89	14,668	11491,377	45,999
30/01/2018 23:00	2,012	428020,031	0,883	14,43	11489,152	46
31/01/2018 00:00	2,012	427900,768	0,901	14,456	11489,115	45,997
31/01/2018 01:00	1,94	427958,599	0,884	14,434	11490,282	46
31/01/2018 02:00	2,006	428149,716	0,87	14,566	11493,352	46,001
31/01/2018 03:00	1,973	428124,861	0,895	15,063	11493,395	46,001
31/01/2018 04:00	2,024	428410,507	0,906	16,05	11491,926	46
31/01/2018 05:00	1,969		0,848	15,877	11496,901	46,001
31/01/2018 06:00	2,046	428091,956	0,914	16,454	11490,328	46,001
31/01/2018 07:00	2,331	427591,018	0,722	15,946	12117,783	49,158
31/01/2018 08:00	2,04	427294,789	0,855	16,368	12258,268	49,867
31/01/2018 09:00	1,987	427145,387	0,824	16,441	12202,707	49,695
31/01/2018 10:00	1,927	427334,368	0,787	16,23	12160,174	49,608
31/01/2018 11:00	1,95	427092,716	0,778	16,05	12038,607	49,064
31/01/2018 12:00	1,94	428143,99	0,796	15,827	11901,196	48,38
31/01/2018 13:00	1,98	428695,638	0,807	15,702	11786,876	47,869
31/01/2018 14:00	1,969	425197,347	0,795	15,652	11688,217	47,441
31/01/2018 15:00	1,934	429333,692	0,805	15,625	11669,747	47,452
31/01/2018 16:00	2,038	427496,197	0,808	15,498	11588,521	46,936
31/01/2018 17:00	43,688	378039,057	0,861	15,894	9736,815	37,566
31/01/2018 18:00	1,939	429466,439	0,811	15,44	11602,105	47,015
31/01/2018 19:00	1,951	429518,444	0,814	15,526	11636,819	47,001
31/01/2018 20:00	1,974	427154,362	0,805	15,656	11664,576	46,999
31/01/2018 21:00	2,026	428623,553	0,826	15,745	11682,507	47,001
31/01/2018 22:00	2,057	428796,286	0,836	15,779	11686,3	47
31/01/2018 23:00	11,869	428780,297	0,832	15,724	11181,05	44,427
01/02/2018 00:00	2,099	428388,74	0,835	15,712	11689,737	46,996
01/02/2018 01:00	2,132	428656,666	0,83	15,719	11694,022	46,999
01/02/2018 02:00	2,73	424506,785	0,812	15,992	11522,433	46,132
01/02/2018 03:00	2,044	428489,901	0,83	15,606	11701,287	47
01/02/2018 04:00	2,472	426729,587	0,848	15,751	11597,824	46,458
01/02/2018 05:00	2,887		0,785	15,984	11523,866	46,054
01/02/2018 06:00	2,219	429271,732	0,834	15,482	11705,792	46,996
01/02/2018 07:00	2,281	428560,575	0,679	15,897	12113,407	49,161
01/02/2018 08:00	2,043	427717,227	0,809	16,22	12305,616	49,98
01/02/2018 09:00	1,997	427433,179	0,803	16,238	12216,026	49,712
01/02/2018 10:00	1,984	427543,379	0,793	16,028	12080,521	49,123
01/02/2018 11:00	1,945	427645,853	0,759	15,82	11991,337	48,678
01/02/2018 12:00	1,928	427441,523	0,777	15,796	11908,51	48,319
01/02/2018 13:00	195,195	341779,011	0,881	15,8	8790,398	31,961
01/02/2018 14:00	9,222	416215,89	0,796	15,977	11313,294	45,507
01/02/2018 15:00	1,924	428864,462	0,795	15,488	11673,865	47,233
01/02/2018 16:00	1,925	428578,295	0,793	15,474	11663,357	47,187
01/02/2018 17:00	1,928	424875,85	0,774	15,585	11687,081	47,285
01/02/2018 18:00	1,931	427779,45	0,785	15,744	11728,812	47,404
01/02/2018 19:00	1,934	427757,617	0,784	16,05	11842,596	47,875
01/02/2018 20:00	1,951	426001,098	0,767	16,111	11921,192	48,093
01/02/2018 21:00	2,009	426330,784	0,801	16,133	11799,37	47,509
01/02/2018 22:00	2,01	426899,622	0,792	16,169	11959,096	48,235
01/02/2018 23:00	2,025	425794,291	0,785	15,747	11851,852	47,628
02/02/2018 00:00	1,996	426468,161	0,807	15,573	11779,614	47,3
02/02/2018 01:00	2,004	426434,03	0,802	15,714	11774,998	47,3
02/02/2018 02:00	1,999	427004,693	0,78	16,014	11774,675	47,284
02/02/2018 03:00	2,013	427190,833	0,81	15,96	11773,639	47,301
02/02/2018 04:00	2,094	427528,298	0,796	16,094	11770,875	47,299
02/02/2018 05:00	2,072		0,757	16,103	11771,047	47,302
02/02/2018 06:00	2,136	428986,307	0,808	16,155	11769,435	47,301
02/02/2018 07:00	2,35	428706,013	0,658	15,487	11797,499	47,472
02/02/2018 08:00	2,091	428212,215	0,784	15,958	11909,096	47,999
02/02/2018 09:00	2	426592,722	0,807	15,845	11892,184	47,997
02/02/2018 10:00	1,987	426983,773	0,816	15,684	11875,308	48,002
02/02/2018 11:00	2,029	427297,987	0,795	15,297	11868,692	47,983
02/02/2018 12:00	1,971	427972,197	0,816	15,156	11829,597	47,836
02/02/2018 13:00	1,944	428253,435	0,811	15,131	11744,608	47,433
02/02/2018 14:00	1,947	424788,907	0,801	15,172	11675,727	47,178
02/02/2018 15:00	1,953	427121,045	0,816	15,278	11534,117	46,498
02/02/2018 16:00	1,945	428682,998	0,815	15,255	11603,01	46,889
02/02/2018 17:00	1,931	425736,498	0,802	15,165	11631,447	47,035
02/02/2018 18:00	1,93	428879,737	0,804	15,275	11677,78	47,165
02/02/2018 19:00	1,941	428803,13	0,809	15,724	11741,944	47,316
02/02/2018 20:00	1,965	427181,597	0,799	15,95	11828,231	47,615
02/02/2018 21:00	1,981	426275,759	0,835	15,995	11870,706	47,758
02/02/2018 22:00	2,017	426823,103	0,826	16,007	11911,125	47,946
02/02/2018 23:00	2,061	428064,68	0,818	16,157	11760,792	47,144
03/02/2018 00:00	2,054	428854,008	0,831	15,808	11724,008	47,016
03/02/2018 01:00	2,144	428476,474	0,821	16,272	11853,705	47,725
03/02/2018 02:00	2,237	428380,306	0,808	16,177	11915,317	47,999
03/02/2018 03:00	2,31	428105,326	0,829	16,46	12002,178	48,467
03/02/2018 04:00	2,049	428404,995	0,834	16,537	12001,569	48,411
03/02/2018 05:00	1,968	423041,488	0,788	16,317	12098,678	48,924
03/02/2018 06:00	1,981	428228,124	0,84	16,119	11984,665	48,27
03/02/2018 07:00	9,83	424097,991	0,698	16,059	11685,661	46,904
03/02/2018 08:00	2,111	428366,375	0,817	16,472	12008,99	48,518
03/02/2018 09:00	2,269	410644,597	0,859	18,751	10920,603	42,979
03/02/2018 10:00	2,319	397359,575	0,86	20,867	10315,755	40,001
03/02/2018 11:00	2,276	391579,701	0,845	19,535	10312,142	39,998
03/02/2018 12:00	2,242	393165,251	0,859	19,244	10305,415	40,002
03/02/2018 13:00	2,292	394035,851	0,867	17,744	10280,808	40
03/02/2018 14:00	2,301	390562,817	0,854	17,41	10262,335	39,998
03/02/2018 15:00	2,229	394898,536	0,869	17,612	10249,97	40,001
03/02/2018 16:00	2,203	395246,8	0,865	17,684	10249,719	39,999
03/02/2018 17:00	48,22	349092,712	0,903	16,994	8785,951	32,339
03/02/2018 18:00	7,593	403069,148	0,874	16,226	10603,631	41,682
03/02/2018 19:00	1,942	430115,804	0,836	15,579	11728,063	47,149
03/02/2018 20:00	1,96	428493,691	0,828	15,515	11780,538	47,295

03/02/2018 21:00	1,973	429074,299	0,85	15,31	11795,187	47,303
03/02/2018 22:00	1,988	429185,641	0,856	15,444	11804,216	47,299
03/02/2018 23:00	2,026	429026,558	0,839	15,567	11813,945	47,301
04/02/2018 00:00	2,026	428984,231	0,854	15,611	11814,892	47,298
04/02/2018 01:00	70,872	372640,368	0,933	14,41	9569,841	35,715
04/02/2018 02:00	109,902	344901,675	0,944	13,913	8429,969	29,999
04/02/2018 03:00	110,433	345402,601	0,967	13,893	8438,133	30,001
04/02/2018 04:00	116,255	345675,044	0,976	13,854	8442,726	30
04/02/2018 05:00	124,702	341380,664	0,929	13,827	8447,055	30
04/02/2018 06:00	121,934	346054,885	0,976	13,99	8450,363	29,998
04/02/2018 07:00	77,437	386688,132	0,759	14,531	10070,946	38,33
04/02/2018 08:00	2,238	427907,745	0,827	15,464	11670,255	46,48
04/02/2018 09:00	2,372	426676,968	0,843	13,713	11150,872	43,997
04/02/2018 10:00	2,473	425239,035	0,823	12,494	11096,817	43,736
04/02/2018 11:00	2,553	415518,734	0,823	12,265	10934,918	43
04/02/2018 12:00	2,286	417576,344	0,827	12,018	10930,735	43
04/02/2018 13:00	2,07	419158,743	0,832	12,44	11025,593	43,522
04/02/2018 14:00	1,981	418368,569	0,821	13,025	11122,087	44,001
04/02/2018 15:00	1,989	422630,355	0,831	13,192	11109,447	43,999
04/02/2018 16:00	1,971	423048,023	0,824	13,246	11097,982	44,001
04/02/2018 17:00	2,017	419980,883	0,813	12,802	11044,755	43,797
04/02/2018 18:00	2,141	418932,168	0,83	12,32	10925,047	43,001
04/02/2018 19:00	2,482	419629,647	0,834	14,209	10976,88	43
04/02/2018 20:00	3,801	422269,873	0,819	14,947	10994,216	43
04/02/2018 21:00	5,152	425041,024	0,849	15,169	11008,832	42,998
04/02/2018 22:00	4,713	424638,792	0,845	15,128	11012,823	43
04/02/2018 23:00	4,767	423952,852	0,834	15,328	11015,485	43
05/02/2018 00:00	2,856	423132,689	0,85	16,733	11019,633	43
05/02/2018 01:00	3,06	423530,735	0,85	16,659	11010,85	43
05/02/2018 02:00	3,797	424104,502	0,837	16,493	11006,466	43,001
05/02/2018 03:00	4,245	423896,888	0,862	16,481	11005,482	42,998
05/02/2018 04:00	4,073	424112,653	0,863	16,44	11028,759	43
05/02/2018 05:00	3,906	418865,331	0,811	16,271	11221,448	43,97
05/02/2018 06:00	2,046	427509,634	0,83	15,764	11981,356	47,701
05/02/2018 07:00	2,4	427232,665	0,674	15,961	12243,216	49,129
05/02/2018 08:00	2,117	427495,307	0,812	15,936	12192,894	49,003
05/02/2018 09:00	30,91	377947,812	0,855	13,575	9811,737	36,733
05/02/2018 10:00	84,547	348936,278	0,889	13,736	8769,233	31,561
05/02/2018 11:00	107,175	323993,751	0,902	15,263	8047,804	28,002
05/02/2018 12:00	86,433	324758,698	0,922	15,692	8032,756	28,001
05/02/2018 13:00	186,611	311726,371	0,94	15,393	7623,811	25,838
05/02/2018 14:00	232,022	304915,53	0,931	15,789	7407,724	24,782
05/02/2018 15:00	162,505	343620,814	0,904	13,059	8619,605	31,09
05/02/2018 16:00	8,349	392612,235	0,857	12,978	10113,712	38,888
05/02/2018 17:00	4,675	416715,6	0,811	14,467	11016,353	43,388
05/02/2018 18:00	1,942	430227,61	0,795	15,517	11872,267	47,543
05/02/2018 19:00	1,94	428500,976	0,797	15,683	11892,248	47,588
05/02/2018 20:00	1,944	426443,876	0,777	15,739	11955,039	47,866
05/02/2018 21:00	2,168	427620,531	0,806	15,746	11780,364	47,085
05/02/2018 22:00	4,588	413232,2	0,831	16,804	10710,438	41,682
05/02/2018 23:00	5,701	402663,587	0,834	18,105	10377,614	39,999
06/02/2018 00:00	4,617	402872,19	0,872	18,152	10382,323	39,999
06/02/2018 01:00	3,828	402932,064	0,868	18,914	10386,048	40,001
06/02/2018 02:00	2,947	398277,493	0,845	19,751	10392,866	39,998
06/02/2018 03:00	3,358	402173,959	0,856	19,555	10389,603	39,999
06/02/2018 04:00	3,404	402527,626	0,858	19,554	10392,317	40
06/02/2018 05:00	5,105	398706,715	0,8	19,083	10386,401	40
06/02/2018 06:00	3,912	410481,452	0,857	18,96	10574,236	40,93
06/02/2018 07:00	4,218	431736,11	0,692	16,859	11167,621	44
06/02/2018 08:00	4,423	427994,625	0,834	15,718	11158,665	44
06/02/2018 09:00	4,89	430523,532	0,818	15,227	11147,551	44,003
06/02/2018 10:00	3,041	428570,182	0,797	15,019	11129,518	43,999
06/02/2018 11:00	2,343	422304,469	0,791	14,026	11267,16	44,442
06/02/2018 12:00	2,126	425407,801	0,793	15,154	11146,24	44
06/02/2018 13:00	2,144	423140,456	0,79	15,84	11135,478	43,968
06/02/2018 14:00	2,133	420487,231	0,78	15,956	11130,614	44,002
06/02/2018 15:00	2,104	423253,069	0,805	15,906	11117,971	44,002
06/02/2018 16:00	2,093	423862,11	0,795	15,882	11118,382	44
06/02/2018 17:00	2,095	422911,233	0,778	15,928	11120,026	44,001
06/02/2018 18:00	2,097	425043,518	0,791	15,956	11132,513	44
06/02/2018 19:00	2,098	426937,91	0,799	16,126	11161,206	43,999
06/02/2018 20:00	2,115	425965,88	0,785	16,208	11185,687	44,001
06/02/2018 21:00	2,158	427961,168	0,807	16,289	11192,417	44
06/02/2018 22:00	2,166	429282,492	0,8	16,758	11378,099	44,93
06/02/2018 23:00	2,188	429436,352	0,803	16,88	11405,113	45
07/02/2018 00:00	2,222	429307,086	0,816	16,904	11405,425	44,997
07/02/2018 01:00	2,197	429191,132	0,814	16,85	11406,887	45,001
07/02/2018 02:00	2,224	424309,849	0,806	17,03	11407,524	45
07/02/2018 03:00	2,23	427837,673	0,816	18,055	11408,111	45
07/02/2018 04:00	2,186	427838,535	0,819	17,851	11405,696	45,001
07/02/2018 05:00	2,23	423844,339	0,76	17,895	11405,945	45
07/02/2018 06:00	2,183	429444,211	0,811	17,86	11542,123	45,688
07/02/2018 07:00	2,632	430524,639	0,646	17,059	11609,951	46
07/02/2018 08:00	2,179	427133,367	0,78	16,608	11597,791	45,992
07/02/2018 09:00	2,317	426525,334	0,831	17,475	11234,788	44,157
07/02/2018 10:00	2,939	409271,512	0,842	17,807	10702,782	41,602
07/02/2018 11:00	2,219	405621,321	0,824	15,499	10746,812	42
07/02/2018 12:00	2,152	407799,554	0,842	15,308	10739,036	42,001
07/02/2018 13:00	2,143	406765,678	0,844	15,379	10729,893	41,999
07/02/2018 14:00	2,109	405640,782	0,831	15,398	10720,681	42
07/02/2018 15:00	2,603	362755,342	0,872	15,726	9453,904	35,419
07/02/2018 16:00	2,145	425108,128	0,846	16,537	11180,506	44,333
07/02/2018 17:00	2,082	428356,192	0,818	16,387	11316,555	45,002
07/02/2018 18:00	16,137	384267,743	0,866	13,764	9882,209	37,54
07/02/2018 19:00	209,468	325584,422	0,952	14,584	7827,051	26,941
07/02/2018 20:00	41,431	358832,057	0,887	12,394	8962,283	32,893
07/02/2018 21:00	46,635	361109,421	0,928	12,206	8999,333	33
07/02/2018 22:00	48,812	361498,498	0,93	12,264	9002,608	33
07/02/2018 23:00	42,884	361013,505	0,919	12,606	9004,552	33,001
08/02/2018 00:00	37,543	360272,104	0,928	12,767	9005,061	32,984
08/02/2018 01:00	244,651	334733,39	0,958	13,511	8127,968	28,139
08/02/2018 02:00	133,438	342074,074	0,922	14,12	8448,051	30,001

08/02/2018 03:00	148,305	345754,219	0,955	13,834	8447,601	29,999
08/02/2018 04:00	109,672	353101,401	0,945	13,493	8688,569	31,259
08/02/2018 05:00	47,562	358168,638	0,87	13,484	9320,316	34,628
08/02/2018 06:00	2,295	428593,001	0,848	18,348	11612,454	46,001
08/02/2018 07:00	2,701	428670,347	0,702	17,061	11603,333	46,001
08/02/2018 08:00	2,183	425042,311	0,837	16,692	11589,57	45,978
08/02/2018 09:00	2,44	387257,884	0,876	14,841	10186,615	38,917
08/02/2018 10:00	2,377	363441,616	0,905	14,288	9389,409	34,999
08/02/2018 11:00	2,342	419755,707	0,831	15,448	11465,875	45,732
08/02/2018 12:00	2,062	428931,599	0,828	15,487	11743,402	47
08/02/2018 13:00	2,048	429226,236	0,832	15,981	11708,012	46,842
08/02/2018 14:00	2,021	427450,595	0,824	15,87	11728,298	46,999
08/02/2018 15:00	2,022	428493,378	0,847	15,228	11705,83	46,999
08/02/2018 16:00	2,001	428634,422	0,847	14,924	11693,078	47,001
08/02/2018 17:00	2,014	427777,254	0,818	15,286	11704,136	47
08/02/2018 18:00	2,02	429545,346	0,837	15,272	11717,635	46,89
08/02/2018 19:00	2,015	430170,788	0,834	15,169	11765,698	46,996
08/02/2018 20:00	2,008	430019,476	0,818	14,473	11787,847	47,003
08/02/2018 21:00	2,085	429057,225	0,826	17,154	11805,782	47
08/02/2018 22:00	2,174	429184,402	0,837	17,413	11808,479	47
08/02/2018 23:00	2,135	425428,846	0,839	17,366	11809,781	47
09/02/2018 00:00	2,156	429080,538	0,857	17,548	11812,248	47
09/02/2018 01:00	2,178	429286,557	0,862	17,579	11813,366	47
09/02/2018 02:00	72,532	367357,124	0,916	14,577	9465,744	35,065
09/02/2018 03:00	99,483	350192,921	0,959	13,61	8635,314	30,999
09/02/2018 04:00	19,388	414949,167	0,887	16,945	11237,036	44,1
09/02/2018 05:00	2,255	423098,569	0,815	17,673	11816,448	46,998
09/02/2018 06:00	2,139	428945,553	0,855	17,733	11881,276	47,336
09/02/2018 07:00	170,738	390100,848	0,733	16,427	10473,029	39,807
09/02/2018 08:00	490,369	297864,496	1,014	13,903	7074,857	21,999
09/02/2018 09:00	468,902	297280,398	0,997	13,869	7037,387	21,997
09/02/2018 10:00	356,114	320001,487	0,979	14,614	7754,159	25,992
09/02/2018 11:00	17,952	399574,957	0,856	16,223	10199,963	38,999
09/02/2018 12:00	16,243	394130,141	0,885	16,684	10111,913	38,999
09/02/2018 13:00	17,479	393094,991	0,89	17,18	10101,502	39,002
09/02/2018 14:00	3,053	367664,799	0,862	19,738	9750,913	36,968
09/02/2018 15:00	278,839	305954,433	1	17,941	7410,462	24,744
09/02/2018 16:00	98,464	358930,285	0,936	21,284	9190,891	34,033
09/02/2018 17:00	3,09	381882,661	0,872	23,377	9980,268	38,21
09/02/2018 18:00	4,197	347179,478	0,938	15,352	8745,041	31,987
09/02/2018 19:00	9,023	349407,953	0,942	14,888	8777,009	31,999
09/02/2018 20:00	16,674	350621,842	0,925	15,362	8796,111	32
09/02/2018 21:00	24,315	351864,223	0,94	15,445	8802,061	32
09/02/2018 22:00	28,085	353091,891	0,945	15,247	8806,111	32,002
09/02/2018 23:00	36,8	350935,689	0,948	14,841	8810,36	32
10/02/2018 00:00	39,7	354330,949	0,981	14,867	8807,006	32
10/02/2018 01:00	48,337	355101,318	0,97	15,108	8806,965	31,999
10/02/2018 02:00	61,161	353082,788	0,967	15,018	8816,722	32
10/02/2018 03:00	59,423	356798,655	0,986	15,03	8817,69	32,001
10/02/2018 04:00	112,307	359704,688	0,975	13,721	8820,353	31,999
10/02/2018 05:00	87,603	354655,233	0,91	14,758	8820,461	31,999
10/02/2018 06:00	85,017	357805,068	0,974	15,184	8819,253	31,999
10/02/2018 07:00	17,226	385542,762	0,749	15,941	9844,586	37,338
10/02/2018 08:00	2,364	382020,196	0,896	17,532	10008,797	38,001
10/02/2018 09:00	4,792	387186,784	0,908	20,814	9968,151	37,999
10/02/2018 10:00	2,873	385254,116	0,888	21,544	9959,404	37,999
10/02/2018 11:00	2,484	380654,071	0,888	22,742	9954,635	37,999
10/02/2018 12:00	2,404	379205,444	0,903	24,562	9952,591	38
10/02/2018 13:00	5,571	382933,403	0,919	19,321	9917,562	38
10/02/2018 14:00	4,384	384152,299	0,905	14,539	9882,726	37,997
10/02/2018 15:00	3,481	386559,891	0,922	14,491	9873,005	38,002
10/02/2018 16:00	4,167	386769,26	0,932	14,531	9879,068	38,001
10/02/2018 17:00	4,931	387161,891	0,912	14,601	9902,447	38
10/02/2018 18:00	4,256	388442,067	0,92	14,862	9924,271	38,001
10/02/2018 19:00	4,073	388865,569	0,916	14,977	9930,763	37,998
10/02/2018 20:00	4,579	389886,937	0,912	14,945	9958,313	38
10/02/2018 21:00	5,209	390353,931	0,935	14,658	9973,913	38
10/02/2018 22:00	4,106	390474,586	0,935	14,738	10013,486	38,001
10/02/2018 23:00	3,868	386639,484	0,916	14,605	9988,475	38,002
11/02/2018 00:00	47,234	376486,383	0,957	14,949	9508,143	35,501
11/02/2018 01:00	166,13	340364,128	1,007	16,255	8254,529	29,001
11/02/2018 02:00	149,059	341017,306	0,99	16,037	8374,941	29,672
11/02/2018 03:00	133,007	345874,268	1,016	16,05	8453,567	30,002
11/02/2018 04:00	138,996	346823	1,009	15,907	8456,301	30,001
11/02/2018 05:00	142,775	343695,237	0,965	15,823	8456,479	30
11/02/2018 06:00	147,962	346884,435	1,017	15,918	8459,717	30
11/02/2018 07:00	131,701	345739,317	0,822	16,138	8452,006	29,998
11/02/2018 08:00	36,368	380651,252	0,947	13,651	9688,247	36,437
11/02/2018 09:00	10,069	391050,019	0,943	13,351	9948,699	38,001
11/02/2018 10:00	6,878	388438,659	0,941	15,269	9939,093	37,999
11/02/2018 11:00	19,707	343732,734	0,966	17,726	8744,334	31,738
11/02/2018 12:00	50,202	325265,379	1,03	18,1	8103,141	28,604
11/02/2018 13:00	117,202	314279,051	1,042	19,391	7712,128	26,577
11/02/2018 14:00	124,803	309739,76	1,035	20,187	7592,114	26
11/02/2018 15:00	113,364	310791,313	1,065	20,379	7577,617	25,999
11/02/2018 16:00	108,799	311266,189	1,077	20,69	7571,85	26,002
11/02/2018 17:00	103,991	311906,281	1,038	21,02	7567,602	25,998
11/02/2018 18:00	120,41	312861,338	1,068	20,106	7581,363	26
11/02/2018 19:00	156,028	315524,287	1,066	19,052	7616,32	26
11/02/2018 20:00	189,309	317520,832	1,041	18,356	7655,048	26,001
11/02/2018 21:00	214,469	319693,832	1,083	17,73	7679,131	26,001
11/02/2018 22:00	179,6	325990,937	1,089	17,243	7858,4	27,011
11/02/2018 23:00	157,368	328894,158	1,071	17,188	8053,344	28
12/02/2018 00:00	159,58	332034,825	1,084	17,064	8054,874	28
12/02/2018 01:00	166,397	332419,793	1,083	17,046	8059,433	28
12/02/2018 02:00	183,22	330700,922	1,098	16,919	8065,833	28
12/02/2018 03:00	177,615	333421,799	1,079	17,066	8064,874	27,998
12/02/2018 04:00	176,202	333367,337	1,08	17,094	8064,479	27,997
12/02/2018 05:00	189,334	331357,34	1,01	16,786	8064,339	28
12/02/2018 06:00	87,971	361323,526	1,065	17,02	9038,391	33,018
12/02/2018 07:00	2,475	427658,702	0,772	19,634	12234,19	49,26
12/02/2018 08:00	2,158	424845,934	0,906	17,252	12355,965	49,983

12/02/2018 09:00	2,03	429552,391		15,97	12297,481	49,953
12/02/2018 10:00	1,97	428596,583	0,835	15,96	12299,862	50
12/02/2018 11:00	1,973	427641,274	0,821	16,106	12267,727	49,931
12/02/2018 12:00	2,02	414718,604	0,847	16,482	11671,267	46,886
12/02/2018 13:00	2,448	354248,457	0,911	18,745	9387,692	35,097
12/02/2018 14:00	2,561	365530,951	0,898	18,28	9765,275	37,232
12/02/2018 15:00	2,021	429701,837	0,866	16,349	11752,633	47,884
12/02/2018 16:00	1,963	430270,119		15,957	11896,498	48,372
12/02/2018 17:00	1,969	429475,39		15,969	11941,919	48,484
12/02/2018 18:00	1,985	429594,459		15,914	11976,682	48,598
12/02/2018 19:00	2,243	399999,449		16,792	10538,599	40,769
12/02/2018 20:00	2,133	428705,437		16,545	11297,178	44,727
12/02/2018 21:00	2,121	430866,591		16,367	11431,546	45,331
12/02/2018 22:00	2,092	431147,261		16,434	11535,745	45,806
12/02/2018 23:00	2,138	425864,238	0,869	16,469	11595,637	46,112
13/02/2018 00:00	2,101	428768,954	0,877	16,584	11650,152	46,277
13/02/2018 01:00	2,181	428886,873	0,877	16,608	11660,416	46,366
13/02/2018 02:00	50,7	376936,95	0,945	19,295	9818,936	36,932
13/02/2018 03:00	2,489	396652,902	0,93	23,157	10406,705	40
13/02/2018 04:00	2,381	396850,46	0,937	23,124	10409,236	40
13/02/2018 05:00	2,369	397124,787	0,865	23,312	10409,616	40,001
13/02/2018 06:00	10,69	412003,869	0,91	19,367	10732,887	41,558
13/02/2018 07:00	7,572	429208,432	0,8	16,425	11586,156	45,87
13/02/2018 08:00	2,36	426508,994	0,898	16,801	12173,215	48,896
13/02/2018 09:00	2,097	429436,805	0,825	16,863	12367,708	49,951
13/02/2018 10:00	2,021	429548,463	0,797	17,11	12321,089	49,851
13/02/2018 11:00	2,059	426716,454	0,766	16,48	12081,231	48,879
13/02/2018 12:00	2,09	428403,316	0,797	16,847	12360,714	49,994
13/02/2018 13:00	2	428766,401	0,791	16,667	12374,274	49,999
13/02/2018 14:00	1,976	427973,721	0,784	15,485	12011,596	48,407
13/02/2018 15:00	2,012	428145,129	0,802	15,9	11963,14	48,384
13/02/2018 16:00	1,974	429788,101	0,792	15,516	11907,641	48
13/02/2018 17:00	1,979	429907,097	0,772	15,647	11948,01	48,175
13/02/2018 18:00	1,973	428920,029	0,789	15,725	12012,996	48,333
13/02/2018 19:00	1,973	428914,7	0,789	15,82	12096,235	48,523
13/02/2018 20:00	1,976	429056,056	0,775	15,812	12186,979	48,912
13/02/2018 21:00	1,986	427652,545	0,785	15,877	12283,821	49,357
13/02/2018 22:00	2,008	427605,612	0,784	16,059	12296,469	49,452
13/02/2018 23:00	2,031	424533,539	0,775	15,818	12160,232	48,583
14/02/2018 00:00	2,088	429273,714	0,812	13,993	11621,418	45,999
14/02/2018 01:00	2,164	429180,856	0,815	13,881	11615,404	46
14/02/2018 02:00	2,184	427475,317	0,805	14,03	11611,678	45,999
14/02/2018 03:00	2,197	429433,283	0,811	14,913	11607,97	45,999
14/02/2018 04:00	2,2	429317,242	0,805	15,602	11662,888	46,39
14/02/2018 05:00	2,141	426885,486	0,757	15,566	11805,477	47,001
14/02/2018 06:00	2,246	429741,208	0,816	16,696	11798,046	46,89
14/02/2018 07:00	7,023	429770,585	0,723	17,205	12136,687	48,668
14/02/2018 08:00	2,09	427704,84	0,79	15,672	12393,669	49,988
14/02/2018 09:00	2,085	427735,496	0,823	15,807	12239,705	49,208
14/02/2018 10:00	2,026	427992,033	0,812	15,701	12288,232	49,555
14/02/2018 11:00	2,003	426593,835	0,788	15,418	12145,195	48,851
14/02/2018 12:00	24,126	398094,545	0,845	14,755	10905,637	42,538
14/02/2018 13:00	136,624	349952,397	0,913	15,109	8981,269	33,001
14/02/2018 14:00	2,052	429271,546	0,796	15,005	12324,611	49,748
14/02/2018 15:00	27,216	385139,168	0,869	14,954	10539,607	40,862
14/02/2018 16:00	99,516	319863,918	0,945	16,388	7876,664	27,321
14/02/2018 17:00	42,615	380348,084	0,865	16,133	10252,692	39,686
14/02/2018 18:00	2,004	430362,839	0,826	15,101	11786,959	47,308
14/02/2018 19:00	2,021	430526,688	0,818	15,307	11859,572	47,455
14/02/2018 20:00	65,553	406045,565	0,855	15,013	10264,844	38,989
14/02/2018 21:00	281,521	315962,585	0,972	14,309	7613,446	25,332
14/02/2018 22:00	418,874	304726,979	0,99	13,51	7225,929	22,998
14/02/2018 23:00	342,311	313013,399	0,966	13,328	7589,975	25,127
15/02/2018 00:00	34,327	412887,533	0,892	16,465	10786,471	41,931
15/02/2018 01:00	2,135	429996,082	0,839	15,445	11804,842	46,997
15/02/2018 02:00	2,107	424807,792	0,843	15,449	11816,053	46,998
15/02/2018 03:00	2,095	425354,997	0,857	15,496	11816,666	47
15/02/2018 04:00	2,088	425127,007	0,855	15,491	11814,34	47
15/02/2018 05:00	2,219	424286,431	0,811	15,68	11809,293	46,999
15/02/2018 06:00	2,204	427209,941	0,852	15,815	11809,323	46,999
15/02/2018 07:00	6,691	426763,446	0,753	15,298	12152,701	48,823
15/02/2018 08:00	2,14	424884,26	0,827	15,573	12383,538	49,879
15/02/2018 09:00	2,069	427598,256	0,821	15,26	12337,748	49,682
15/02/2018 10:00	2,056	427355,311	0,808	15,283	12054,453	48,497
15/02/2018 11:00	2,034	426339,392	0,815	14,736	12044,606	48,264
15/02/2018 12:00	2,03	427639,881	0,818	14,705	11893,086	47,627
15/02/2018 13:00	87,146	348084,542	0,912	15,061	8961,85	32,746
15/02/2018 14:00	118,052	316327,404	0,946	15,875	7816,981	27
15/02/2018 15:00	29,653	401439,845	0,877	15,364	10713,544	41,919
15/02/2018 16:00	1,999	428931,422	0,836	15,244	11776,525	47,287
15/02/2018 17:00	1,997	429214,151	0,824	15,11	11780,998	47,283
15/02/2018 18:00	2,001	429112,427	0,837	14,957	11762,203	47,121
15/02/2018 19:00	2,008	429581,328	0,826	14,821	11773,911	46,993
15/02/2018 20:00	2,024	429791,811	0,819	14,761	11799,159	47
15/02/2018 21:00	2,046	429750,633	0,847	14,788	11810,625	47
15/02/2018 22:00	2,064	429578,513	0,851	15,078	11812,273	47
15/02/2018 23:00	2,122	426966,318	0,83	15,227	11816,193	47
16/02/2018 00:00	2,101	429617,582	0,852	15,302	11822,639	46,997
16/02/2018 01:00	2,123	429663,563	0,851	15,358	11817,543	46,999
16/02/2018 02:00	2,107	428046,048	0,83	15,456	11817,087	46,997
16/02/2018 03:00	2,162	429843,802	0,848	15,445	11818,701	47,001
16/02/2018 04:00	2,112	429636,768	0,853	15,464	11822,847	46,998
16/02/2018 05:00	2,2	425907,508	0,809	15,611	11815,554	47
16/02/2018 06:00	2,161	428833,842	0,851	15,512	11816,207	47,002
16/02/2018 07:00	6,547	429434,644	0,746	14,352	11812,207	47
16/02/2018 08:00	2,189	427392,848	0,821	14,931	11775,037	46,881
16/02/2018 09:00	2,193	428847,45	0,815	16,77	11817,797	46,986
16/02/2018 10:00	2,107	429297,829	0,792	14,883	11783,644	46,974
16/02/2018 11:00	2,076	427387,955	0,789	14,699	11765,038	46,956
16/02/2018 12:00	2,018	428746,547	0,798	14,752	11752,002	46,961
16/02/2018 13:00	2,007	429150,518	0,791	14,834	11745,174	46,995
16/02/2018 14:00	2,019	428116,576	0,789	14,935	11723,734	46,941

16/02/2018 15:00	2,011	429411,611	0,795	15,018	11710,722	46,941
16/02/2018 16:00	2,007	429425,815	0,793	15,089	11699,499	46,928
16/02/2018 17:00	2,001	429563,202	0,779	15,032	11710,82	46,916
16/02/2018 18:00	2,021	429549,781	0,794	14,119	11471,725	45,568
16/02/2018 19:00	2,035	429854,115	0,806	13,925	11397,12	45,19
16/02/2018 20:00	2,032	428875,345	0,786	14,751	11595,834	46,001
16/02/2018 21:00	2,07	428000,414	0,813	14,74	11607,041	46,001
16/02/2018 22:00	2,088	428800,959	0,809	14,583	11608,725	46
16/02/2018 23:00	2,137	426292,969	0,801	14,65	11614,061	46,001
17/02/2018 00:00	2,174	428945,455	0,818	14,547	11616,434	46,001
17/02/2018 01:00	2,179	428627,924	0,822	14,319	11608,07	45,999
17/02/2018 02:00	2,232	426558,858	0,808	14,306	11605,202	45,999
17/02/2018 03:00	2,13	427038,017	0,826	14,349	11609,733	46
17/02/2018 04:00	2,21	426759,251	0,829	14,95	11607,751	46,001
17/02/2018 05:00	2,25		0,777	14,69	11601,8	46,001
17/02/2018 06:00	2,163	429811,483	0,828	15,186	11731,751	46,648
17/02/2018 07:00	7,715	429046,574	0,734	14,86	11803,223	47,001
17/02/2018 08:00	2,124	426848,908	0,796	15,065	11842,458	47,271
17/02/2018 09:00	2,092	427057,728	0,796	15,283	11985,491	47,997
17/02/2018 10:00	2,109	426979,311	0,799	15,184	11944,138	47,872
17/02/2018 11:00	2,087	426929,377	0,786	15,118	11836,381	47,503
17/02/2018 12:00	2,06	428364,927	0,79	14,934	11744,177	47,001
17/02/2018 13:00	2,024	428615,713	0,792	14,884	11736,901	46,998
17/02/2018 14:00	2,027	428633,813	0,775	15,177	11736,735	47,079
17/02/2018 15:00	2,022	428439,949	0,803	15,322	11736,53	47,107
17/02/2018 16:00	2,003	428857,275	0,795	15,383	11743,864	47,151
17/02/2018 17:00	2,012	429090,589	0,778	15,483	11759,907	47,22
17/02/2018 18:00	1,999	429487,26	0,788	15,606	11827,953	47,504
17/02/2018 19:00	1,988	429470,238	0,771	15,654	11957,624	47,949
17/02/2018 20:00	1,988	429535,551	0,76	15,396	11998,831	48,002
17/02/2018 21:00	2,006	429679,673	0,782	15,368	12006,791	48,001
17/02/2018 22:00	2,046	429677,107	0,795	15,684	11973,998	47,748
17/02/2018 23:00	2,094	427333,886	0,792	15,779	11877,614	47,291
18/02/2018 00:00	2,198	428375,264	0,81	16,178	11789,153	46,964
18/02/2018 01:00	2,167	428941,343	0,811	16,916	11903,751	47,3
18/02/2018 02:00	56,371	395529,307	0,827	16,174	10566,965	40,544
18/02/2018 03:00	196,124	342120,999	0,931	14,119	8331,022	29,2
18/02/2018 04:00	190,341	341905,991	0,93	14,118	8335,282	29,201
18/02/2018 05:00	180,358		0,865	14,075	8368,956	29,384
18/02/2018 06:00	193,091	344719,089	0,927	13,796	8421,531	29,6
18/02/2018 07:00	42,402	418385,988	0,762	17,016	11394,705	44,766
18/02/2018 08:00	2,225	427130,294	0,79	16,731	11784,443	46,742
18/02/2018 09:00	2,133	428332,559	0,833	15,708	11609,664	46,107
18/02/2018 10:00	2,099	428375,435	0,823	15,534	11524,043	45,788
18/02/2018 11:00	2,111	428371,729	0,805	15,319	11454,459	45,524
18/02/2018 12:00	2,161	428124,497	0,812	15,172	11378,942	45,123
18/02/2018 13:00	2,202	411888,123	0,828	16,089	10937,108	42,852
18/02/2018 14:00	2,119	417506,452	0,833	15,861	11070,307	43,725
18/02/2018 15:00	2,091	424121,503	0,841	15,495	11142,605	44,397
18/02/2018 16:00	2,078	425806,67	0,839	15,29	11211,691	44,541
18/02/2018 17:00	2,056	426502,013	0,809	15,255	11598,238	46,519
18/02/2018 18:00	2,064	428897,332	0,815	15,111	11704,715	46,629
18/02/2018 19:00	2,124	429107,948	0,817	16,62	11617,054	45,997
18/02/2018 20:00	2,177	411295,868	0,816	15,493	10786,518	41,718
18/02/2018 21:00	2,099	423320,083	0,832	16,106	11564,968	45,791
18/02/2018 22:00	2,031	428640,288	0,829	15,388	11912,693	47,301
18/02/2018 23:00	2,043	426317,271	0,829	15,095	11915,852	47,299
19/02/2018 00:00	2,043	427931,77	0,845	14,848	11917,537	47,298
19/02/2018 01:00	2,059	428027,887	0,858	14,805	11917,682	47,301
19/02/2018 02:00	2,129	425793,224	0,845	14,59	11912,133	47,301
19/02/2018 03:00	2,204	427735,198	0,861	17,282	11928,314	47,302
19/02/2018 04:00	2,196	427628,545	0,861	17,638	11925,396	47,3
19/02/2018 05:00	2,263		0,782	17,728	11926,635	47,3
19/02/2018 06:00	2,342	428447,559	0,845	17,899	11925,203	47,301
19/02/2018 07:00	7,589	428447,174	0,764	17,699	11923,772	47,3
19/02/2018 08:00	2,281	426863,288	0,819	17,078	11919,23	47,302
19/02/2018 09:00	2,205	428012,259	0,834	16,823	11814,849	46,917
19/02/2018 10:00	62,666	402242,313	0,86	14,963	10649,665	40,977
19/02/2018 11:00	234,246	331830,213	0,956	13,231	7950,898	27,262
19/02/2018 12:00	381,97	298526,796	0,999	13,882	7187,211	22,998
19/02/2018 13:00	84,844	389627,991	0,898	14,824	10143,446	38,9
19/02/2018 14:00	2,211	399897,503	0,849	14,903	10736,655	41,711
19/02/2018 15:00	2,113	419994,859	0,863	14,554	11120,889	43,779
19/02/2018 16:00	2,093	424165,817	0,857	14,754	11184,425	44,204
19/02/2018 17:00	2,085	425975,563	0,832	14,91	11220,893	44,411
19/02/2018 18:00	2,086	426409,249	0,853	15,424	11379,773	45,235
19/02/2018 19:00	2,063	428218,46	0,841	15,131	11882,231	47,297
19/02/2018 20:00	2,091	428754,205	0,825	16,401	11909,126	47,3
19/02/2018 21:00	134,717	30448,99	14,148	5,971	1491,181	3,033
19/02/2018 22:00		0		0,04	0	-0,069
19/02/2018 23:00		0		0	0	-0,08
20/02/2018 00:00		0		0	0	-0,087
20/02/2018 01:00		0		0	0	-0,092
20/02/2018 02:00		0		0	0	-0,094
20/02/2018 03:00		0		0	0	-0,095
20/02/2018 04:00		0		0	0	-0,095
20/02/2018 05:00		0		0	0	-0,095
20/02/2018 06:00		0		0	0	-0,095
20/02/2018 07:00		0		0,001	0	-0,094
20/02/2018 08:00		0		0	0	-0,096
20/02/2018 09:00		0		0	0	-0,1
20/02/2018 10:00		0		0	0	-0,106
20/02/2018 11:00		0		0	0	-0,111
20/02/2018 12:00		0		0	0	-0,113
20/02/2018 13:00		0		0	0	-0,117
20/02/2018 14:00		0		0	0	-0,114
20/02/2018 15:00		0		0	0	-0,108
20/02/2018 16:00		0		0	0	-0,106
20/02/2018 17:00		0		0	0	-0,099
20/02/2018 18:00		0		0	0	-0,092
20/02/2018 19:00		0		0	279,339	-0,087
20/02/2018 20:00		0		0	0	-0,09

20/02/2018 21:00		0		0,001	390,626	-0,083
20/02/2018 22:00		0		0	0	-0,092
20/02/2018 23:00		0		0	0	-0,09
21/02/2018 00:00		0		0	0	-0,09
21/02/2018 01:00		0		0	0	-0,091
21/02/2018 02:00		0		0	0	-0,092
21/02/2018 03:00		0		1,761	3955,814	10,333
21/02/2018 04:00	201,803	51172,489	0,308	9,539	7835,037	26,299
21/02/2018 05:00	481,504		1,057	12,757	7139,515	21,979
21/02/2018 06:00	519,312	308077,666	1,136	12,947	7170,402	22,001
21/02/2018 07:00	550,033	305531,211	0,997	13,131	7153,908	22,002
21/02/2018 08:00	487,318	304577,326	1,121	12,797	7131,212	22
21/02/2018 09:00	453,024	300801,497	1,043	12,98	7088,046	22,002
21/02/2018 10:00	424,456	296839,021	1,006	12,926	7055,755	22,001
21/02/2018 11:00	399,241	294480,351	1,008	13,325	7030,284	22,005
21/02/2018 12:00	377,617	292588,353	1,03	13,978	7003,322	22,002
21/02/2018 13:00	356,901	291356,894	1,027	14,32	6982,523	21,999
21/02/2018 14:00	342,705	291580,884	1,021	14,561	6964,584	22
21/02/2018 15:00	330,956	292177,328	1,048	15,078	6946,75	22
21/02/2018 16:00	328,131	292011,14	1,043	14,868	6943,531	22,001
21/02/2018 17:00	350,013	293728,506	1,015	13,944	6959,344	22,002
21/02/2018 18:00	375,438	295220,83	1,033	13,493	6985,699	22,001
21/02/2018 19:00	410,086	298217,859	1,032	13,007	7033,911	22,001
21/02/2018 20:00	439,123	300056,827	1,014	12,988	7076,243	21,999
21/02/2018 21:00	458,8	300747,412	1,027	12,983	7099,391	21,999
21/02/2018 22:00	466,649	301679,153	1,037	13,078	7104,475	22
21/02/2018 23:00	474,295	299755,084	1,026	12,992	7105,437	21,999
22/02/2018 00:00	485,595	302285,859	1,037	13,063	7116,953	22,001
22/02/2018 01:00	491,053	304562,292	1,053	12,845	7151,639	22,211
22/02/2018 02:00	428,271	306646,476	1,067	12,738	7376,683	23,231
22/02/2018 03:00	496,908	297562,323	1,107	12,605	7146,794	22
22/02/2018 04:00	459,42	315835,253	1,073	13,062	7729,971	25,176
22/02/2018 05:00	113,144		0,914	15,386	9737,943	35,879
22/02/2018 06:00	3,505	397047,302	0,938	16,419	10380,09	39,46
22/02/2018 07:00	107,062	395739,825	0,833	16,6	10350,045	39,253
22/02/2018 08:00	3,101	391696,293	0,904	16,534	10172,833	38,357
22/02/2018 09:00	2,411	379866,156	0,903	16,36	9928,439	37,247
22/02/2018 10:00	2,433	373617,428	0,888	16,13	9763,775	36,564
22/02/2018 11:00	2,448	365175,639	0,881	15,775	9548,266	35,47
22/02/2018 12:00	2,415	359384,138	0,988	15,913	9375,831	34,854
22/02/2018 13:00	2,017	176081,94	75,574	12,881	9311,823	34,572
22/02/2018 14:00	7,45	182516,812	76,679	13,437	8731,914	31,675
22/02/2018 15:00	3,894	0	271,039	3,687	8393,785	30
22/02/2018 16:00	5,219	295079,14	0,905	15,732	8952,249	32,727
22/02/2018 17:00	2,425	355671,608	0,827	15,863	9204,807	33,989
22/02/2018 18:00	2,403	358872,33	0,849	14,692	9215,394	34
22/02/2018 19:00	2,518	362081,212	0,845	13,839	9238,822	33,999
22/02/2018 20:00	3,474	364555,037	0,827	13,018	9256,614	34
22/02/2018 21:00	5	365418,617	0,847	12,469	9255,89	33,999
22/02/2018 22:00	8,466	366675,572	0,849	11,838	9254,067	34,002
22/02/2018 23:00	5,243	380970,436	0,826	14,291	9813,864	36,797
23/02/2018 00:00	2,362	390159,653	0,837	14,868	10066,362	38,002
23/02/2018 01:00	2,452	390002,95	0,833	15,004	10070,231	38,001
23/02/2018 02:00	2,393	389337,378	0,815	15,249	10073,621	38
23/02/2018 03:00	2,411	389804,8	0,847	15,004	10070,321	38,001
23/02/2018 04:00	2,417	389378,678	0,851	15,109	10068,923	37,998
23/02/2018 05:00	2,492		0,792	14,853	10066,048	37,999
23/02/2018 06:00	2,687	390197,184	0,857	14,7	10068,1	38,004
23/02/2018 07:00	102,88	389401,889	0,762	15,13	10068,86	38,002
23/02/2018 08:00	2,644	388808,946	0,825	15,263	10052,623	37,999
23/02/2018 09:00	2,391	386534,036	0,828	15,964	10047,404	38
23/02/2018 10:00	119,877	78710,622	57,525	6,62	2875,079	7,587
23/02/2018 11:00		0		0,098	0	-0,097
23/02/2018 12:00	16,011	118793,38	508,539	10,671	7295,767	26,794
23/02/2018 13:00	2,072	426434,857	0,857	15,777	12419,083	49,994
23/02/2018 14:00	2,047	426244,11	0,796	15,756	12409,708	50,001
23/02/2018 15:00	2,025	427483,003	0,799	15,927	12415,983	50,001
23/02/2018 16:00	2,021	428108,014	0,797	15,78	12424,618	49,999
23/02/2018 17:00	2,013	428061,787	0,784	15,508	12437,24	50,001
23/02/2018 18:00	2,014	427385,13	0,798	15,691	12428,723	49,998
23/02/2018 19:00	2,049	427803,693	0,795	16,637	12441,423	49,937
23/02/2018 20:00	2,043	427712,98	0,778	17,107	12465,598	49,999
23/02/2018 21:00	59,589	366728,637	0,883	13,914	9559,078	35,271
23/02/2018 22:00	444,857	302968,115	0,976	12,816	7152,55	22,339
23/02/2018 23:00	501,338	301939,858	0,965	12,497	7144,696	22
24/02/2018 00:00	508,171	302227,859	0,983	12,433	7149,567	22,002
24/02/2018 01:00	228,882	340717,929	0,957	13,273	8330,642	28,982
24/02/2018 02:00	229,521	336536,47	0,956	13,398	8143,5	28
24/02/2018 03:00	244,736	336744,609	0,965	13,393	8152,141	28,001
24/02/2018 04:00	237,75	336316,215	0,973	13,654	8146,804	27,999
24/02/2018 05:00	60,825		0,838	18,352	10662,1	41
24/02/2018 06:00	2,788	428834,05	0,859	20,525	11256,489	44
24/02/2018 07:00	99,526	428709,153	0,761	18,966	11252,451	44,001
24/02/2018 08:00	2,506	428201,151	0,841	17,04	11241,208	43,997
24/02/2018 09:00	2,589	427318,755	0,786	17,069	11298,512	44,323
24/02/2018 10:00	2,098	426775,45	0,75	15,307	12462,906	49,998
24/02/2018 11:00	2,054	426731,945	0,731	14,988	12452,711	49,997
24/02/2018 12:00	2,057	427610,235	0,753	14,509	12053,056	48,204
24/02/2018 13:00	2,028	427918,373	0,774	14,772	11968,587	47,846
24/02/2018 14:00	2,025	428043,389	0,749	15,305	11994,018	48,082
24/02/2018 15:00	2,01	428097,773	0,772	15,532	12044,932	48,498
24/02/2018 16:00	2,002	428227,689	0,765	15,586	12071,25	48,633
24/02/2018 17:00	1,997	428397,821	0,747	15,555	12052,706	48,494
24/02/2018 18:00	2,015	428039,193	0,753	15,479	11926,08	47,955
24/02/2018 19:00	2,01	428260,469	0,751	15,553	12145,969	48,615
24/02/2018 20:00	1,995	427950,732	0,733	15,797	12287,445	49,247
24/02/2018 21:00	1,996	426513,428	0,748	15,968	12397,387	49,74
24/02/2018 22:00	2,159	427383,96	0,758	14,659	11829,438	47,012
24/02/2018 23:00	2,294	425936,24	0,765	14,709	11642,71	46
25/02/2018 00:00	2,379	425237,44	0,792	14,302	11642,086	46,001
25/02/2018 01:00	113,126	381348,015	0,848	13,854	9950,888	37,147
25/02/2018 02:00	186,652	342410,707	0,885	13,38	8416,832	29,352

25/02/2018 03:00	202,09	342439,905	0,894	13,358	8337,557	29
25/02/2018 04:00	202,654	342181,853	0,908	13,471	8338,312	28,998
25/02/2018 05:00	186,903		0,855	13,415	8405,277	29,432
25/02/2018 06:00	167,417	348427,464	0,903	13,288	8526,409	29,999
25/02/2018 07:00	231,168	347695,267	0,788	13,623	8521,979	30,001
25/02/2018 08:00	75,18	368283,528	0,849	15,103	9930,956	37,312
25/02/2018 09:00	2,201	427225,119	0,762	16,613	11847,381	46,995
25/02/2018 10:00	2,196	426938,175	0,762	16,766	11829,83	46,993
25/02/2018 11:00	2,198	426820,031	0,754	16,814	11826,195	46,996
25/02/2018 12:00	2,106	426749,679	0,748	15,123	11804,047	46,986
25/02/2018 13:00	2,067	427015,319	0,768	14,791	11781,007	46,999
25/02/2018 14:00	2,088	427230,974	0,753	14,68	11770,434	47,001
25/02/2018 15:00	2,057	428094,258	0,76	14,718	11762,838	47
25/02/2018 16:00	2,037	428555,638	0,75	14,695	11759,334	47,001
25/02/2018 17:00	2,035	429375,322	0,738	14,712	11767,74	46,998
25/02/2018 18:00	2,035	429267,119	0,749	14,869	11786,963	46,998
25/02/2018 19:00	2,036	428745,384	0,742	15,347	11932,842	47,561
25/02/2018 20:00	2,046	427978,829	0,732	15,581	12055,821	48,019
25/02/2018 21:00	2,06	427212,37	0,753	15,629	12119,733	48,289
25/02/2018 22:00	2,162	427726,46	0,766	16,322	11920,874	47,27
25/02/2018 23:00	2,274	428000,053	0,757	17,208	11895,041	46,999
26/02/2018 00:00	2,974	423625,619	0,773	16,96	11739,482	46,092
26/02/2018 01:00	160,013	344234,68	0,87	13,316	8424,729	29,5
26/02/2018 02:00	165,836	343911,75	0,868	13,287	8425,041	29,5
26/02/2018 03:00	170,15	343436,734	0,887	13,234	8425,653	29,5
26/02/2018 04:00	78,892	395448,495	0,827	15,894	10532,709	40,167
26/02/2018 05:00	2,383		0,743	18,042	11888,422	46,998
26/02/2018 06:00	2,316	428764,499	0,784	17,643	11885,066	47,001
26/02/2018 07:00	93,684	428458,545	0,699	16,982	11810,311	46,933
26/02/2018 08:00	2,273	428569,352	0,767	15,842	11851,861	46,971
26/02/2018 09:00	2,122	424734,876	0,772	16,408	12325,177	49,558
26/02/2018 10:00	2,108	420655,937	0,786	15,877	11963,022	47,622
26/02/2018 11:00	2,095	425655,109	0,749	15,749	12358,23	49,531
26/02/2018 12:00	2,2	424731,191	0,794	14,813	11309,593	44,666
26/02/2018 13:00	56,727	389176,691	0,831	14,828	10160,605	38,705
26/02/2018 14:00	2,174	425915,788	0,786	15,846	11476,118	45,505
26/02/2018 15:00	2,098	428512,755	0,798	14,697	11289,129	44,619
26/02/2018 16:00	2,126	421227,935	0,791	15,012	11180,877	44,235
26/02/2018 17:00	2,099	428328,635	0,767	14,594	11275,859	44,482
26/02/2018 18:00	2,107	428414,566	0,78	14,847	11418,581	44,968
26/02/2018 19:00	21,494	408129,846	0,802	15,233	11078,021	43,036
26/02/2018 20:00	2,1	430995,547	0,763	15,328	11538,777	45,347
26/02/2018 21:00	2,103	429519,231	0,781	15,394	11575,233	45,499
26/02/2018 22:00	2,101	429539,34	0,783	15,59	11636,586	45,748
26/02/2018 23:00	2,166	427285,78	0,786	16,08	11550,997	45,293
27/02/2018 00:00	2,305	426983,898	0,792	17,427	12037,093	47,808
27/02/2018 01:00	2,314	427557,795	0,789	17,636	11968,15	47,301
27/02/2018 02:00	83,734	382188,864	0,839	14,988	10045,225	37,646
27/02/2018 03:00	3,423	425861,704	0,804	17,811	11904,16	47,001
27/02/2018 04:00	2,276	425884,998	0,8	17,532	11868,709	46,975
27/02/2018 05:00	2,234		0,74	16,668	11940,895	47,367
27/02/2018 06:00	415,033	325434,731	0,913	13,311	8011,422	26,153
27/02/2018 07:00	618,451	305929,677	0,804	12,626	7257,272	22,001
27/02/2018 08:00	565,534	305445,327	0,913	12,608	7235,851	22
27/02/2018 09:00	233,883	343862,389	0,921	12,68	8423,818	29,307
27/02/2018 10:00	37,311	414718,936	0,829	15,346	11715,948	46,336
27/02/2018 11:00	2,158	428404,064	0,764	16,369	12447,736	49,978
27/02/2018 12:00	2,128	429566,723	0,78	16,208	12451,964	49,99
27/02/2018 13:00	2,118	428479,36	0,793	16,14	12448,158	50,001
27/02/2018 14:00	2,514	425773,967	0,794	15,451	11812,325	46,91
27/02/2018 15:00	2,143	427942,204	0,825	14,642	11300,851	44,553
27/02/2018 16:00	2,12	428932,758	0,824	14,645	11293,079	44,566
27/02/2018 17:00	2,109	429429,67	0,806	14,728	11309,48	44,627
27/02/2018 18:00	2,118	428903,752	0,821	15,189	11325,506	44,819
27/02/2018 19:00	2,162	427219,761	0,823	15,777	11357,274	44,633
27/02/2018 20:00	2,635	416558,751	0,824	17,46	10852,309	42
27/02/2018 21:00	2,603	415889,422	0,85	18,216	10863,045	42,001
27/02/2018 22:00	2,485	416379,514	0,854	18,75	10868,435	41,998
27/02/2018 23:00	2,515	424142,527	0,825	17,833	11444,223	44,826
28/02/2018 00:00	2,522	423788,111	0,859	18,836	11101,183	43,201
28/02/2018 01:00	2,489	425583,052	0,858	19,158	11072,981	43,079
28/02/2018 02:00	2,403	428190,066	0,834	19,802	11256,34	44,001
28/02/2018 03:00	2,458	427902,212	0,849	19,888	11259,466	44
28/02/2018 04:00	2,517	428096,462	0,845	20,12	11258,275	44,003
28/02/2018 05:00	2,368		0,784	17,183	12088,96	48,114
28/02/2018 06:00	2,189	426750,601	0,833	15,988	12484,469	49,998
28/02/2018 07:00	90,985	426930,218	0,733	15,558	12486,651	50
28/02/2018 08:00	2,247	426831,232	0,803	15,663	12480,583	50,001
28/02/2018 09:00	2,143	427036,484	0,698	16,811	12467,317	50
28/02/2018 10:00	2,185	426069,072	0,772	16,394	12387,369	49,442
28/02/2018 11:00	25,158	398468,166	0,816	13,285	10496,058	40,253
28/02/2018 12:00	216,998	320566,536	0,933	13,782	7830,99	26,561
28/02/2018 13:00	226,57	317501,848	0,93	14,064	7741,849	26,143
28/02/2018 14:00	221,869	317261,028	0,929	14,131	7750,556	26,32
28/02/2018 15:00	13,276	365743,093	0,886	11,819	9385,058	35,002
28/02/2018 16:00	4,525	393200,158	0,857	13,505	10450,513	40,317
28/02/2018 17:00	2,127	426506,481	0,801	15,096	11501,13	46,125
28/02/2018 18:00	2,098	428215,262	0,806	15,394	11926,677	47,806
28/02/2018 19:00	2,069	429518,42	0,79	15,919	12317,915	49,299
28/02/2018 20:00	2,11	424900,091	0,784	16,115	12352,825	49,332
28/02/2018 21:00	2,144	427597,885	0,794	16,132	12384,043	49,425
28/02/2018 22:00	2,142	427842,238	0,807	16,432	12395,822	49,501
28/02/2018 23:00	2,317	426934,909	0,819	16,459	11694,152	45,925
01/03/2018 00:00	2,313	426815,823	0,841	16,565	11551,552	45,347
01/03/2018 01:00	2,251	427854,904	0,833	16,989	11698,196	46
01/03/2018 02:00	2,327	428025,048	0,819	17,512	11701,761	46
01/03/2018 03:00	4,417	421986,879	0,843	17,439	11400,607	44,43
01/03/2018 04:00	418,85	316552,227	0,963	13,494	7634,204	24,37
01/03/2018 05:00	524,529		0,936	13,109	7182,024	22,001
01/03/2018 06:00	523,85	303144,759	1,005	13,222	7186,241	22
01/03/2018 07:00	570,508	303076,755	0,876	13,201	7185,379	22
01/03/2018 08:00	506,028	302771,241	0,96	12,875	7167,155	22,001

01/03/2018 09:00	467,596	298537,708	6,982	12,968	7114,544	22
01/03/2018 10:00	354,418	321108,867	0,956	14,113	7985,43	26,467
01/03/2018 11:00	368,054	298121,929	0,959	13,317	7186,687	22,748
01/03/2018 12:00	395,986	290592,126	0,999	13,616	7024,496	22
01/03/2018 13:00	369,449	289556,508	1,013	13,98	6996,146	21,998
01/03/2018 14:00	353,102	289476,763	0,991	14,492	6971,845	22
01/03/2018 15:00	339,839	290182,723	1,014	15,022	6956,035	21,999
01/03/2018 16:00	329,855	290736,746	1,01	15,537	6947,875	22,001
01/03/2018 17:00	337,602	291409,09	0,993	15,057	6953,351	22
01/03/2018 18:00	360,426	294276,073	1,008	14,272	6985,599	22
01/03/2018 19:00	400,939	296349,201	1	13,375	7038,324	22
01/03/2018 20:00	424,581	295371,387	0,985	13,14	7071,716	21,999
01/03/2018 21:00	433,497	299675,847	1,015	13,154	7115,124	22,251
01/03/2018 22:00	204,984	330202,927	0,994	13,614	8077,302	27,608
01/03/2018 23:00	139,525	360557,754	0,939	14,333	8886,873	31,831
02/03/2018 00:00	6,951	401728,585	0,897	15,851	10376,682	39,629
02/03/2018 01:00	23,188	372994,997	0,914	12,071	9503,142	35,104
02/03/2018 02:00	13,048	378339,933	0,903	11,563	9679,598	36,001
02/03/2018 03:00	15,975	378896,744	0,928	11,168	9669,643	36
02/03/2018 04:00	18,074	379838,297	0,911	11,089	9668,082	35,999
02/03/2018 05:00	19,155		0,87	11,08	9660,196	35,998
02/03/2018 06:00	22,391	381048,105	0,928	10,934	9662,178	35,999
02/03/2018 07:00	94,623	424900,579	0,778	17,313	11433,444	44,908
02/03/2018 08:00	2,23	426448,591	0,813	15,612	12381,096	49,437
02/03/2018 09:00	3,854	418174,949	6,221	16,084	11061,596	43,068
02/03/2018 10:00	2,134	427885,22	0,755	15,323	12327,391	49,475
02/03/2018 11:00	2,157	426023,487	0,735	15,436	11912,37	47,741
02/03/2018 12:00	2,172	424989,99	0,767	14,781	11340,14	44,556
02/03/2018 13:00	2,181	424923,54	0,767	15,269	11464,454	45,707
02/03/2018 14:00	2,127	428839,106	0,75	15,476	11927,297	47,806
02/03/2018 15:00	2,117	428836,123	0,765	15,682	11978,33	48
02/03/2018 16:00	2,108	429862,545	0,758	15,619	11985,943	48,002
02/03/2018 17:00	2,108	430061,6	0,741	15,296	11987,793	47,955
02/03/2018 18:00	2,101	430456,357	0,752	15,084	12032,37	48,002
02/03/2018 19:00	2,121	430362,626	0,747	15,767	12063,264	48
02/03/2018 20:00	2,136	426483,881	0,742	15,858	12079,797	47,99
02/03/2018 21:00	2,162	428462,503	0,772	15,636	12087,87	48
02/03/2018 22:00	2,224	428441,719	0,763	15,702	12092,524	47,999
02/03/2018 23:00				16,624		
03/03/2018 00:00	2,537	414045,204	0,79	17,408	11122,606	43,221
03/03/2018 01:00	2,496	414591,216	0,799	18,602	10863,397	42
03/03/2018 02:00	2,688	415661,849	0,787	18,615	10866,499	41,999
03/03/2018 03:00	3,209	417192,87	0,811	17,97	10863,364	41,999
03/03/2018 04:00	3,147	417433,973	0,801	18,22	10862,98	42,001
03/03/2018 05:00	3,46		0,761	18,168	10864,757	42
03/03/2018 06:00	2,816	417869,191	0,799	18,826	10862,578	41,999
03/03/2018 07:00	90,508	425784,855	0,698	17,762	11589,266	45,65
03/03/2018 08:00	2,485	429160,739	0,751	16,604	11885,239	46,973
03/03/2018 09:00	2,381	428768,681	5,993	16,635	11872,99	46,994
03/03/2018 10:00	2,253	427606,186	0,782	15,874	11671,626	46,283
03/03/2018 11:00	2,23	427451,776	0,745	15,778	11763,033	46,878
03/03/2018 12:00	2,147	425878,9	0,768	15,574	12045,446	48
03/03/2018 13:00	2,148	426856,2	0,775	15,411	12037,737	47,999
03/03/2018 14:00	2,12	427239,104	0,765	15,419	12024,829	48
03/03/2018 15:00	2,107	430195,877	0,775	15,384	12008,712	48,001
03/03/2018 16:00	2,103	430489,647	0,767	15,158	12004,86	47,999
03/03/2018 17:00	2,104	430578,025	0,754	15,052	12008,58	47,998
03/03/2018 18:00	2,11	430322,767	0,764	15,709	12029,312	48,001
03/03/2018 19:00	2,121	430112,699	0,764	15,606	12063,933	47,999
03/03/2018 20:00	2,124	426339,194	0,758	14,848	12079,468	47,999
03/03/2018 21:00	2,165	429599,939	0,774	14,744	12089,466	47,999
03/03/2018 22:00	3,265	421940,825	0,792	16,195	11267,875	43,966
03/03/2018 23:00	2,764		0,789	18,686	10824,582	41,788
04/03/2018 00:00	2,74	417328,295	0,807	18,805	10869,34	42,001
04/03/2018 01:00	3,357	418582,797	0,813	18,565	10866,101	42
04/03/2018 02:00	4,651	419106,959	0,802	18,259	10864,938	42
04/03/2018 03:00	4,97	419297,175	0,803	18,308	10864,141	41,999
04/03/2018 04:00	3,909	419147,58	0,809	18,475	10869,149	41,998
04/03/2018 05:00	4,585		0,768	18,371	10869,663	42,001
04/03/2018 06:00	5,027	419370,662	0,821	18,402	10872,278	42,001
04/03/2018 07:00	91,251	419858,15	0,734	17,962	10868,801	42
04/03/2018 08:00	8,834	420264,257	0,81	16,516	10854,167	42
04/03/2018 09:00	5,439	417429,954	6,182	16,696	10838,102	42
04/03/2018 10:00	3,5	415205,029	0,794	16,736	10828,962	42
04/03/2018 11:00	2,493	411639,762	0,801	16,471	10831,295	42,001
04/03/2018 12:00	2,309	411823,805	0,804	14,853	10824,923	41,997
04/03/2018 13:00	2,253	410119,374	0,814	14,186	10816,36	42,003
04/03/2018 14:00	2,361	414386,427	0,809	15,02	10914,708	42,592
04/03/2018 15:00	2,375	419452,821	0,82	15,498	10996,77	42,99
04/03/2018 16:00	2,436	420495,754	0,822	16,031	10984,572	43
04/03/2018 17:00	2,47	417089,064	0,807	16,243	10987,562	43
04/03/2018 18:00	2,269	429360,832	0,809	16,332	11592,949	45,984
04/03/2018 19:00	2,148	430812,385	0,801	16,31	12341,808	49,562
04/03/2018 20:00	2,17	428704,369	0,778	16,539	12475,751	49,998
04/03/2018 21:00	25,113	402549,759	0,863	14,719	10796,476	41,582
04/03/2018 22:00	68,825	361581,788	0,939	11,086	9013,383	32,752
04/03/2018 23:00	247,543	321548,279	0,945	12,293	8090,811	27,348
05/03/2018 00:00	463,872	299649,076	0,995	13,552	7117,77	22
05/03/2018 01:00	220,706	352978,677	0,95	15,342	8776,037	31,273
05/03/2018 02:00	3,27	420111,649	0,856	18,101	10908,682	42,326
05/03/2018 03:00	3,944	420217,9	0,878	17,495	11034,104	42,944
05/03/2018 04:00	2,86	428949,261	0,852	17,222	11935,986	47,242
05/03/2018 05:00	2,355		0,794	17,941	11726,253	46,224
05/03/2018 06:00	2,336	429899,431	0,834	17,516	11889,806	46,996
05/03/2018 07:00	88,691	428678,859	0,747	17,314	11940,715	47,506
05/03/2018 08:00	2,396	428269,836	0,809	17,152	12254,135	48,781
05/03/2018 09:00	2,259	427656,371	5,934	16,395	12269,169	49,099
05/03/2018 10:00	2,21	427865,708	0,754	15,628	12335,188	49,448
05/03/2018 11:00	2,146	428170,971	0,745	15,973	12437,403	49,995
05/03/2018 12:00	2,112	428839,287	0,747	15,927	12410,374	49,898
05/03/2018 13:00	2,108	428518,324	0,752	15,737	12341,9	49,646
05/03/2018 14:00	2,088	428157,523	0,745	15,736	12257,623	49,423

05/03/2018 15:00	1,875	419742,837	0,78	16,082	11551,158	46,083
05/03/2018 16:00		429154,249	0,6	16,635	12086,237	48,591
05/03/2018 17:00	2,397	372783,717	0,789	16,741	10091,741	38,08
05/03/2018 18:00	2,278	405769,136	0,794	16,471	11061,542	43,296
05/03/2018 19:00	2,496	365852,122	0,795	16,983	9573,001	35,404
05/03/2018 20:00	2,606	421329,679	0,758	17,371	11547,893	45,156
05/03/2018 21:00	2,595	375371,775	0,815	17,453	9900,026	36,724
05/03/2018 22:00	2,317	423698,012	0,794	17,229	11613,21	45,855
05/03/2018 23:00	2,176	427958,039	0,769	15,639	12096,066	48
06/03/2018 00:00	2,441	428156,985	0,778	16,078	12091,261	47,99
06/03/2018 01:00	2,276	428453,549	0,783	17,877	12108,931	47,998
06/03/2018 02:00	2,247	428419,359	0,768	17,853	12116,181	48
06/03/2018 03:00	2,253	428356,347	0,773	17,955	12113,306	47,998
06/03/2018 04:00	2,25	428441,041	0,782	17,975	12109,213	47,999
06/03/2018 05:00	2,238		0,732	17,995	12098,654	48,002
06/03/2018 06:00	2,216	428350,504	0,79	16,745	12110,691	48,001
06/03/2018 07:00	35,45	428875,361	0,796	17,674	12112,903	48
06/03/2018 08:00	2,386	428856,682	0,764	17,964	12092,942	47,938
06/03/2018 09:00	2,278	428772,242	5,832	17,719	11873,867	46,998
06/03/2018 10:00	67,546	318282,657	60,426	15,776	9452,022	34,61
06/03/2018 11:00	32,657	0	6017,643	1,617	18,885	-0,083
06/03/2018 12:00	1,187	0	18343,695	0,03	0	-0,091
06/03/2018 13:00	0,848	0	22110,342	0	0	-0,092
06/03/2018 14:00	0,753	0	19516,39	0	0	-0,091
06/03/2018 15:00	0,724	0	17620,863	0	0	-0,091
06/03/2018 16:00	0,717	0	531,382	0	0	-0,092
06/03/2018 17:00	0,717	0	430,284	0	0	-0,094
06/03/2018 18:00	0,727	0	412,936	0	0	-0,096
06/03/2018 19:00	0,781	0	571,106	0	0	-0,102
06/03/2018 20:00	0,846	0	2128,933	0	0	-0,102
06/03/2018 21:00	74,161	0	388,431	3,363	3383,943	7,914
06/03/2018 22:00	178,18	237913,337	0,537	15,193	9626,69	35,438
06/03/2018 23:00	2,195	430958,318	0,76	17,553	12515,497	49,999
07/03/2018 00:00	2,293	428843,599	0,769	17,641	12515,788	49,998
07/03/2018 01:00	2,691	427218,683	0,792	18,645	11624,633	45,681
07/03/2018 02:00	2,914	426669,164	0,798	19,347	11073,774	43,003
07/03/2018 03:00	2,786	427187,456	0,807	19,213	11218,089	43,738
07/03/2018 04:00	2,211	429847,562	0,775	17,964	12506,508	50
07/03/2018 05:00			1,093	16,653	12490,959	49,999
07/03/2018 06:00	2,397	430668,623	0,77	17,357	12510,22	49,999
07/03/2018 07:00	34,059	430569,893	1,049	16,955	12512,349	49,998
07/03/2018 08:00	2,29	430314,578	0,752	16,172	12510,534	49,999
07/03/2018 09:00	2,284	429229,123	5,806	16,844	12496,041	49,983
07/03/2018 10:00		430790,619	14,679	16,653	12485,353	49,997
07/03/2018 11:00	10,187	430829,177	1,649	17,05	12469,24	49,996
07/03/2018 12:00	1,59	432824,813	0,725	16,469	12468,484	50
07/03/2018 13:00	1,555	432442,932	0,745	16,386	12409,827	49,766
07/03/2018 14:00	1,537	429009,224	0,741	16,108	12363,399	49,631
07/03/2018 15:00	1,524	431944,098	0,756	16,197	12330,286	49,5
07/03/2018 16:00	1,529	432173,743	0,748	16,063	12330,802	49,5
07/03/2018 17:00	1,533	428320,514	0,739	16,379	12331,756	49,5
07/03/2018 18:00	1,54	431120,455	0,755	16,547	12346,603	49,48
07/03/2018 19:00	1,561	431327,091	0,758	16,862	12379,317	49,501
07/03/2018 20:00	1,601	428527,468	0,741	16,852	12394,818	49,5
07/03/2018 21:00	1,719	430425,471	0,764	16,98	12447,825	49,729
07/03/2018 22:00	1,672	431135,215	0,777	17,311	12508,139	49,999
07/03/2018 23:00	1,752	429764,177	0,765	17,326	12509,365	50,001
08/03/2018 00:00	1,881	429414,885	0,785	17,305	12510,362	50
08/03/2018 01:00	2,11	430085,815	0,798	18,187	11590,058	45,493
08/03/2018 02:00	1,982	429706,953	0,791	18,69	11297,025	43,999
08/03/2018 03:00	2,174	430382,945	0,804	20,294	11293,289	43,999
08/03/2018 04:00	1,987	430400,734	0,768	17,935	12326,55	49,107
08/03/2018 05:00	1,775		0,736	17,486	12497,157	49,999
08/03/2018 06:00	1,772	431719,357	0,784	17,074	12512,386	50
08/03/2018 07:00	6,104	432478,444	0,779	17,359	12515,868	50,001
08/03/2018 08:00	1,765	432935,593	0,758	16,492	12515,673	49,998
08/03/2018 09:00	1,822	430153,127	5,782	17,017	12500,252	49,998
08/03/2018 10:00	1,692	430112,175	0,752	16,696	12486,441	49,993
08/03/2018 11:00	148,428	361446,277	0,836	14,76	9207,185	33,225
08/03/2018 12:00	211,768	315038,635	0,884	14,535	7725,17	25,998
08/03/2018 13:00	218,978	314850,299	0,88	14,349	7718,295	26
08/03/2018 14:00	210,792	311985,76	0,865	14,651	7706,989	26
08/03/2018 15:00	214,455	315929,404	0,892	14,612	7703,85	26
08/03/2018 16:00	162,468	347394,745	0,867	15,009	8803,235	31,79
08/03/2018 17:00	1,547	428540,609	0,739	16,602	12267,013	49,14
08/03/2018 18:00	1,533	430788,207	0,744	16,821	12360,3	49,509
08/03/2018 19:00	1,532	429743,935	0,751	17,015	12494,831	50,001
08/03/2018 20:00	1,579	426754,931	0,725	17,187	12513,285	50,001
08/03/2018 21:00	1,677	426880,002	0,76	17,251	12519,241	49,999
08/03/2018 22:00	1,63	427354,703	0,77	17,219	12520,866	50,001
08/03/2018 23:00	1,712	427418,91	0,752	17,278	12519,635	50,002
09/03/2018 00:00	1,686	428178,364	0,762	17,323	12515,633	50
09/03/2018 01:00	1,894	427795,737	0,771	17,777	11812,274	46,616
09/03/2018 02:00	1,8	431772,734	0,76	18,344	11854,687	46,7
09/03/2018 03:00	1,865	432392,659	0,752	18,271	11853,184	46,7
09/03/2018 04:00	1,78	430530,158	0,768	17,747	11834,57	46,713
09/03/2018 05:00	1,772		0,71	17,432	12497,04	49,998
09/03/2018 06:00	1,725	429056,926	0,765	17,227	12506,976	50
09/03/2018 07:00	6,257	428997,764	0,755	17,059	12509,308	49,999
09/03/2018 08:00	1,777	428926,628	0,743	16,893	12506,884	49,991
09/03/2018 09:00	1,719	429430,183	5,775	16,999	12450,376	49,721
09/03/2018 10:00	1,744	429700,907	0,739	16,578	12324,745	49,142
09/03/2018 11:00	1,671	430224,25	0,731	16,123	12121,302	48,001
09/03/2018 12:00	1,645	431105,073	0,724	16,29	12056,778	47,999
09/03/2018 13:00	1,598	434443,673	0,728	16,309	12010,844	47,883
09/03/2018 14:00	1,573	431456,022	0,726	16,485	12114,984	48,514
09/03/2018 15:00	1,537	434840,58	0,748	16,319	12210,461	49,002
09/03/2018 16:00	1,548	433544,279	0,744	16,357	12168,812	48,742
09/03/2018 17:00	1,525	427378,535	0,718	16,774	12280,955	49,273
09/03/2018 18:00	1,52	429821,044	0,729	16,99	12354,164	49,499
09/03/2018 19:00	1,538	429826,45	0,728	17,034	12379,165	49,499
09/03/2018 20:00	1,604	428035,298	0,716	17,051	12390,809	49,5

09/03/2018 21:00	1,657	428726,25	0,742	16,871	12392,726	49,5
09/03/2018 22:00	1,587	429879,522	0,735	16,684	12400,301	49,502
09/03/2018 23:00	1,511	430513,706	0,721	16,515	12401,13	49,5
10/03/2018 00:00	1,506	430908	0,738	15,929	12403,347	49,502
10/03/2018 01:00	1,55	430656,478	0,734	16,074	12408,302	49,502
10/03/2018 02:00	1,6	429415,485	0,72	18,559	12050,721	47,944
10/03/2018 03:00	1,619	430561,95	0,733	18,782	12119,153	48
10/03/2018 04:00	1,64	430116,66	0,755	18,788	12123,728	48
10/03/2018 05:00	1,692		0,712	19,188	12281,657	48,924
10/03/2018 06:00	1,664	432523,208	0,735	19,309	12409,755	49,498
10/03/2018 07:00	5,618	430512,481	0,732	19,249	12410,785	49,501
10/03/2018 08:00	1,728	430613,137	0,73	17,594	12088,358	48,099
10/03/2018 09:00	1,65	430147,406	6,005	17,105	11889,738	47,07
10/03/2018 10:00	1,637	429336,212	0,788	16,398	12295,336	49,246
10/03/2018 11:00	1,532	425790,967	0,765	16,854	12464,448	50
10/03/2018 12:00	1,522	429947,215	0,778	17,003	12463,953	49,99
10/03/2018 13:00	1,55	430009,839	0,79	16,328	12197,957	48,627
10/03/2018 14:00	1,539	426459,768	0,787	16,194	12140,175	48,499
10/03/2018 15:00	1,533	430273,406	0,805	16,23	12115,893	48,474
10/03/2018 16:00	1,534	430464,733	0,802	15,976	12106,699	48,498
10/03/2018 17:00	1,534	427556,948	0,789	15,813	12103,037	48,5
10/03/2018 18:00	1,541	430505,744	0,803	15,904	12136,418	48,5
10/03/2018 19:00	1,556	430452,881	0,796	16,628	12257,83	48,936
10/03/2018 20:00	1,574	428972,392	0,783	17,022	12399,404	49,499
10/03/2018 21:00	1,646	432310,549	0,817	16,983	12409,513	49,501
10/03/2018 22:00	1,604	432562,786	0,822	16,852	12408,98	49,5
10/03/2018 23:00	1,634	430311,767	0,815	16,733	12414,085	49,498
11/03/2018 00:00	1,724	429449,434	0,825	16,08	12412,415	49,501
11/03/2018 01:00	1,638	429471,084	0,831	15,953	12413,667	49,5
11/03/2018 02:00	1,754	427813,262	0,821	15,627	12414,399	49,5
11/03/2018 03:00	1,689	427526,167	0,831	15,786	12419,777	49,5
11/03/2018 04:00	1,905	428017,697	0,824	15,535	12420,129	49,5
11/03/2018 05:00	1,663	424665,02	0,793	15,482	12416,415	49,5
11/03/2018 06:00	1,73	430102,606	0,855	17,165	12337,922	49,016
11/03/2018 07:00	7,372	429815,273	0,85	18,098	12108,961	47,989
11/03/2018 08:00	1,772	429217,685	0,818	17,278	12101,579	48,001
11/03/2018 09:00	1,7	429078,989	5,968	17,442	12080,55	48,001
11/03/2018 10:00	1,656	430728,903	0,769	16,79	11780,723	46,941
11/03/2018 11:00	1,67	418980,44	0,762	16,059	11356,201	44,567
11/03/2018 12:00	1,612	432014,69	0,768	15,663	11524,384	45,504
11/03/2018 13:00	1,593	431504,177	0,774	15,627	11465,241	45,259
11/03/2018 14:00	1,574	428209,666	0,773	15,643	11448,506	45,338
11/03/2018 15:00	1,554	429633,525	0,782	16,34	11842,325	47,406
11/03/2018 16:00	1,511	431738,537	0,77	16,932	12264,922	49,502
11/03/2018 17:00	1,518	427993,031	0,754	17,007	12264,526	49,5
11/03/2018 18:00	1,61	431569,998	0,774	17,154	12132,174	48,876
11/03/2018 19:00	1,605	430830,922	0,774	15,916	12321,076	49,501
11/03/2018 20:00	1,682	428853,234	0,761	15,899	12347,745	49,503
11/03/2018 21:00	1,625	428433,577	0,795	15,769	12355,31	49,5
11/03/2018 22:00	1,529	430121,766	0,802	15,722	12354,3	49,5
11/03/2018 23:00	1,595	431583,486	0,797	16,137	12360,326	49,501
12/03/2018 00:00	1,587	431832,497	0,804	18,751	12378,234	49,501
12/03/2018 01:00	1,677	432464,247	0,797	18,672	12386,214	49,472
12/03/2018 02:00	1,617	433420,037	0,781	18,681	12382,891	49,473
12/03/2018 03:00	1,742	434016,227	0,8	18,965	12387,774	49,498
12/03/2018 04:00	1,712	434145,471	0,798	18,854	12385,957	49,499
12/03/2018 05:00	1,686	427919,122	0,759	18,879	12373,52	49,501
12/03/2018 06:00	1,765	428873,422	0,81	19,17	12391,619	49,5
12/03/2018 07:00	7,064	428387,499	0,766	18,827	12386,573	49,481
12/03/2018 08:00	1,798	430951,933	0,759	18,523	12378,092	49,499
12/03/2018 09:00	1,661	430324,812	5,848	17,848	12160,151	48,622
12/03/2018 10:00	1,633	432061,636	0,767	16,738	12297,784	49,368
12/03/2018 11:00	1,541	429191,657	0,754	16,358	12430,84	50,001
12/03/2018 12:00	1,536	434018,573	0,768	16,4	12357,594	49,554
12/03/2018 13:00	1,512	434300,363	0,759	15,819	12266,616	49,334
12/03/2018 14:00	1,498	430727,988	0,758	16,677	12375,487	49,959
12/03/2018 15:00	1,494	430678,585	0,782	17,137	12380,669	49,999
12/03/2018 16:00	1,495	431043,185	0,771	17,043	12372,235	49,999
12/03/2018 17:00	1,5	426634,526	0,744	17,104	12363,857	50
12/03/2018 18:00	1,515	427284,339	0,765	17,295	12408,292	49,999
12/03/2018 19:00	1,584	427689,444	0,763	17,4	12456,751	50
12/03/2018 20:00	1,57	426216,175	0,743	17,256	12474,096	49,999
12/03/2018 21:00	1,616	424829,18	0,769	16,847	12491,319	50
12/03/2018 22:00	1,591	424545,994	0,781	16,356	12487,99	50
12/03/2018 23:00	1,581	423613,381	0,772	16,206	12488,305	49,999
13/03/2018 00:00	1,53	424575,407	0,792	16,057	12494,026	49,999
13/03/2018 01:00	1,57	424851,987	0,796	15,702	12494,962	49,999
13/03/2018 02:00	1,692	423891,816	0,779	15,73	12496,894	50,001
13/03/2018 03:00	1,675	424290,523	0,803	17,088	12392,469	49,527
13/03/2018 04:00	1,839	425501,612	0,807	18,17	11873,055	46,997
13/03/2018 05:00	1,821	420529,451	0,754	20,149	12044,687	47,908
13/03/2018 06:00	1,694	427031,962	0,796	19,049	12521,153	49,999
13/03/2018 07:00	6,561	426940,957	0,774	19,125	12506,753	49,957
13/03/2018 08:00	1,767	426867,468	0,773	18,841	12498,551	50,003
13/03/2018 09:00	1,685	423545,932	5,986	18,33	12280,656	49,305
13/03/2018 10:00	1,721	412988,062	0,779	16,742	11773,03	46,517
13/03/2018 11:00	1,613	420980,296	0,744	16,947	12454,236	50,002
13/03/2018 12:00	1,587	425896,257	0,755	17,062	12432,737	49,994
13/03/2018 13:00	1,522	426588,561	0,76	16,952	12421,45	49,999
13/03/2018 14:00	1,527	422799,839	0,748	16,877	12403,748	49,999
13/03/2018 15:00	1,526	426653,62	0,769	16,875	12390,024	50
13/03/2018 16:00	1,527	426775,407	0,759	16,948	12225,576	49,29
13/03/2018 17:00	1,493	425487,819	0,75	16,781	12393,357	49,999
13/03/2018 18:00	1,506	426736,864	0,763	16,213	12408,112	49,961
13/03/2018 19:00	1,52	426022,554	0,765	16,361	12461,542	50
13/03/2018 20:00	1,531	424691,91	0,735	15,854	12479,52	49,999
13/03/2018 21:00	1,635	423583,156	0,762	15,747	12483,521	50
13/03/2018 22:00	1,733	423979,912	0,772	15,643	12486,847	50,002
13/03/2018 23:00	1,598	424990,904	0,773	16,014	12490,65	50
14/03/2018 00:00	1,636	425766,212	0,796	17,993	12456,17	49,707
14/03/2018 01:00	2,305	426379,355	0,805	19,175	12023,899	47,806
14/03/2018 02:00	2,591	421276,915	0,805	20,816	11737,861	46,304

14/03/2018 03:00	1,886	425875,835	0,816	19,632	11893,609	47
14/03/2018 04:00	1,797	425210,302	0,822	19,249	12042,112	47,739
14/03/2018 05:00	1,788	419729,198	0,746	18,827	12481,801	49,955
14/03/2018 06:00	1,683	426110,964	0,793	19,538	12518,935	49,997
14/03/2018 07:00	6,273	426329,33	0,788	19,055	12518,15	49,998
14/03/2018 08:00	1,807	422451,857	0,78	18,498	12504,425	49,951
14/03/2018 09:00	1,779	424938,357	6,008	18,45	12416,053	49,654
14/03/2018 10:00	1,689	425298,016	0,796	18,349	12335,079	49,484
14/03/2018 11:00	1,635	421852,074	0,794	16,757	12012,128	48,013
14/03/2018 12:00	1,538	425019,58	0,802	15,742	12446,288	50,001
14/03/2018 13:00	1,526	425880,435	0,81	16,104	12429,889	49,963
14/03/2018 14:00	1,532	423637,533	0,795	16,059	12408,479	49,958
14/03/2018 15:00	1,492	426220,626	0,822	15,91	12385,753	49,986
14/03/2018 16:00	1,509	426880,915	0,81	16,365	12331,115	49,71
14/03/2018 17:00	1,497	425197,024	0,796	16,034	12378,149	49,964
14/03/2018 18:00	1,517	426513,252	0,801	16,006	12411,438	50,002
14/03/2018 19:00	1,582	426686,861	0,791	16,13	12460,78	49,99
14/03/2018 20:00	1,639	425154,493	0,793	16,22	12489,912	49,994
14/03/2018 21:00	1,616	425436,008	0,824	15,747	12497,482	50
14/03/2018 22:00	1,649	425725,162	0,84	15,558	12498,152	50,001
14/03/2018 23:00	1,722	424003,238	0,82	17,5	12512,742	50
15/03/2018 00:00	1,68	423748,724	0,844	18,866	12509,08	49,987
15/03/2018 01:00	1,665	424060,596	0,83	18,832	12505,557	49,963
15/03/2018 02:00	1,72	421548,929	0,805	18,784	12517,417	50,001
15/03/2018 03:00	1,761	426138,618	0,832	19,25	12514,791	50,002
15/03/2018 04:00	1,729	426377,874	0,819	19,317	12514,075	49,999
15/03/2018 05:00	1,848	421061,482	0,752	19,038	12506,018	49,983
15/03/2018 06:00	1,856	427472,078	0,817	17,89	12513,306	50,001
15/03/2018 07:00	6,272	427260,074	0,802	17,957	12509,133	49,999
15/03/2018 08:00	1,771	424221,772	0,79	18,204	12504,419	49,999
15/03/2018 09:00	1,647	430080,965	5,914	17,552	12483,194	50
15/03/2018 10:00	1,655	430837,498	0,814	16,244	12254,63	49,341
15/03/2018 11:00	1,628	427214,822	0,815	15,918	12428,938	50,002
15/03/2018 12:00	1,589	431336,057	0,818	16,603	12409,498	49,932
15/03/2018 13:00	2,015	427851,106	0,841	17,115	12084,273	48,478
15/03/2018 14:00	1,525	429691,987	0,816	16,967	12398,259	50
15/03/2018 15:00	1,532	429511,072	0,84	16,888	12383,302	50
15/03/2018 16:00	1,531	427755,301	0,827	16,85	12381,091	49,998
15/03/2018 17:00	1,518	426402,616	0,8	16,813	12377,524	49,914
15/03/2018 18:00	1,815	388949,659	0,856	17,33	10350,919	39,389
15/03/2018 19:00	1,93	376128,83	0,865	17,149	9880,957	36,745
15/03/2018 20:00	1,837	398807,776	0,841	18,352	10506,544	40,572
15/03/2018 21:00	1,7	424890,496	0,833	18,996	11480,468	45,681
15/03/2018 22:00	1,593	426696,412	0,827	16,622	12504,636	50
15/03/2018 23:00	1,672	425923,834	0,827	15,755	12508,164	50,001
16/03/2018 00:00	1,672	419235,129	0,844	16,506	11988,254	47,278
16/03/2018 01:00	1,93	398369,845	0,887	18,199	10505,694	39,867
16/03/2018 02:00	1,682	414414,195	0,848	16,628	11937,563	47,12
16/03/2018 03:00	1,63	425994,503	0,842	15,676	12519,857	49,999
16/03/2018 04:00	1,591	426152,47	0,838	15,619	12517,809	50
16/03/2018 05:00	1,702	417970,597	0,798	16,599	12504,177	50,001
16/03/2018 06:00	1,769	426472,824	0,838	17,978	12402,751	49,432
16/03/2018 07:00	7,272	426811,878	0,816	17,704	12520,248	49,997
16/03/2018 08:00	1,786	423163,79	0,81	18,087	12513,752	50,001
16/03/2018 09:00	1,669	426812,303	5,943	18,198	12499,903	49,999
16/03/2018 10:00	1,696	426884,693	0,792	17,464	12267,072	49,272
16/03/2018 11:00	1,56	423093,951	0,777	15,81	12455,189	49,999
16/03/2018 12:00	1,554	426985,105	0,775	16,689	12447,47	49,994
16/03/2018 13:00	1,817	424559,255	0,796	17,283	12042,991	48,101
16/03/2018 14:00	1,546	425062,84	0,769	16,879	12403,794	49,981
16/03/2018 15:00	1,511	426474,932	0,784	16,823	12399,687	49,999
16/03/2018 16:00	1,519	426894,664	0,777	16,906	12403,19	49,999
16/03/2018 17:00	1,51	425583,221	0,755	16,867	12409,513	50,001
16/03/2018 18:00	1,518	427640,788	0,756	16,96	12443,711	49,998
16/03/2018 19:00	1,533	427593,836	0,759	16,654	12487,098	50,001
16/03/2018 20:00	1,53	426532,538	0,742	15,998	12503,709	49,999
16/03/2018 21:00	1,584	425773,868	0,764	17,255	12510,269	50,001
16/03/2018 22:00	1,642	425963,496	0,76	19,248	12520,879	49,998
16/03/2018 23:00	1,706	425218,125	0,762	19,2	12523,235	49,998
17/03/2018 00:00	1,652	425276,948	0,814	19,164	12525,428	50
17/03/2018 01:00	1,637	425471,203	0,818	19,358	12529,187	50
17/03/2018 02:00	2,577	421257,285	0,792	19,246	12449,39	49,577
17/03/2018 03:00	1,717	425278,803	0,806	19,262	12530,979	49,999
17/03/2018 04:00	1,677	425330,845	0,816	19,308	12528,3	49,999
17/03/2018 05:00	1,736	419363,869	0,739	19,822	12530,576	49,998
17/03/2018 06:00	1,764	426519,351	0,784	19,53	12535,216	49,999
17/03/2018 07:00	6,776	426861,707	0,793	19,408	12527,524	49,998
17/03/2018 08:00	1,703	423344,522	0,787	18,518	12403,324	49,594
17/03/2018 09:00	1,66	424548,205	5,978	18,122	12500,856	49,971
17/03/2018 10:00	1,72	425070,31	0,751	18,22	12479,342	49,941
17/03/2018 11:00	1,594	421724,968	0,747	18,045	12250,012	49,069
17/03/2018 12:00	1,575	426741,767	0,744	16,128	12299,576	49,429
17/03/2018 13:00	1,608	419006,555	0,764	16,244	11681,265	45,967
17/03/2018 14:00	1,711	407098,5	0,759	16,4	10809,227	41,649
17/03/2018 15:00	1,695	405379,857	0,778	15,553	10672,656	41,139
17/03/2018 16:00	2,192	411380,369	0,771	16,146	10727,831	41,51
17/03/2018 17:00	2,289	420724,596	0,752	17,388	11304,265	44,537
17/03/2018 18:00	1,557	425476,618	0,755	15,046	12176,533	48,475
17/03/2018 19:00	1,548	425813,571	0,758	15,509	12202,233	48,5
17/03/2018 20:00	1,607	425056,62	0,748	17,291	12013,143	47,596
17/03/2018 21:00	1,643	426968,001	0,754	18,602	12036,952	47,5
17/03/2018 22:00	1,615	427216,638	0,76	18,599	12034,869	47,501
17/03/2018 23:00	1,61	421456,887	0,768	18,649	12033,225	47,501
18/03/2018 00:00	1,995	424817,04	0,774	20,656	11838,819	46,478
18/03/2018 01:00	2,146	425202,609	0,765	21,764	11724,837	46,001
18/03/2018 02:00	2,241	421932,949	0,757	21,744	11726,105	45,998
18/03/2018 03:00	2,473	425794,236	0,778	21,518	11724,719	45,999
18/03/2018 04:00	2,351	426158,534	0,777	21,417	11723,621	46
18/03/2018 05:00	2,162	423170,68	0,735	21,465	11727,258	46,002
18/03/2018 06:00	2,261	427387,071	0,771	21,248	11735,268	46
18/03/2018 07:00	7,282	427341,312	0,77	21,434	11728,072	46
18/03/2018 08:00	1,794	423243,338	0,761	19,533	12325,091	49,146

18/03/2018 09:00	1,701	426106,61	6,045	18,964	12408,799	49,484
18/03/2018 10:00	1,738	426564,636	0,795	16,743	12224,861	48,821
18/03/2018 11:00	1,564	423670,158	0,762	16,503	12317,377	49,351
18/03/2018 12:00	1,504	426918,888	0,781	16,543	12473,731	50
18/03/2018 13:00	1,508	427019,56	0,782	16,84	12473,464	49,988
18/03/2018 14:00	1,535	425552,615	0,777	16,89	12457,924	50,001
18/03/2018 15:00	1,645	413251,98	0,819	16,294	11190,868	43,896
18/03/2018 16:00	1,9	424467,01	0,819	17,448	11225,6	44,329
18/03/2018 17:00	1,752	426204,893	0,791	17,899	11598,978	45,95
18/03/2018 18:00	1,612	428251,648	0,799	17,376	11858,002	46,997
18/03/2018 19:00	1,667	428213,862	0,797	17,533	11899,668	46,998
18/03/2018 20:00	1,654	428121,967	0,795	17,642	11916,177	46,998
18/03/2018 21:00	1,69	427776,889	0,836	17,919	11917,969	46,991
18/03/2018 22:00	1,63	427896,72	0,846	18,05	11916,743	46,997
18/03/2018 23:00	1,651	423327,602	0,845	18,157	11908,764	46,921
19/03/2018 00:00	1,864	426867,216	0,866	20,49	11709,049	45,999
19/03/2018 01:00	1,962	426931,352	0,859	20,907	11706,057	45,999
19/03/2018 02:00	2,177	422671,583	0,831	20,95	11711,037	46,001
19/03/2018 03:00	2,55	426230,556	0,851	21,434	11710,727	46
19/03/2018 04:00	2,958	426351,79	0,859	21,522	11706,677	46,001
19/03/2018 05:00	2,15	421986,516	0,802	20,001	12125,179	48,1
19/03/2018 06:00	1,778	426537,717	0,844	19,177	12518,226	49,986
19/03/2018 07:00	6,53	426583,422	0,821	18,94	12520,914	49,995
19/03/2018 08:00	1,717	423013,641	0,809	17,987	12448,939	49,659
19/03/2018 09:00	1,677	426830,041	6,03	15,911	12395,799	49,745
19/03/2018 10:00	1,646	426857,446	0,807	15,735	12384,715	50,001
19/03/2018 11:00	1,605	424923,28	0,79	16,733	12380,869	49,999
19/03/2018 12:00	1,566	426727,712	0,808	16,694	12471,094	49,896
19/03/2018 13:00	1,607	425152,265	0,819	16,63	12149,132	48,572
19/03/2018 14:00	1,574	425321,633	0,794	16,658	12464,713	49,999
19/03/2018 15:00	1,54	426853,064	0,813	16,705	12465,368	49,999
19/03/2018 16:00	1,639	426409,504	0,815	16,645	12465,368	49,999
19/03/2018 17:00	2,264	412826,875	0,821	16,968	12465,368	49,999
19/03/2018 18:00	2,564	416151,928	0,843	17,299	12465,368	49,999
19/03/2018 19:00	3,112	416722,778	0,847	17,78	12465,368	49,999
19/03/2018 20:00	4,628	417219,598	0,849	17,818	12465,368	49,999
19/03/2018 21:00	5,481	416024,126	0,873	17,904	12465,368	49,999
19/03/2018 22:00	6,436	416640,242	0,886	17,834	12465,368	49,999
19/03/2018 23:00	7,158	414352,351	0,872	17,784	12465,368	49,999
20/03/2018 00:00	9,218	419263,836	0,88	17,692	12465,368	49,999
20/03/2018 01:00	9,074	419220,895	0,871	17,822	12465,368	49,999
20/03/2018 02:00	8,703	413493,557	0,868	17,757	12465,368	49,999
20/03/2018 03:00	10,984	416966,004	0,889	17,646	12465,368	49,999
20/03/2018 04:00	10,539	418592,29	0,901	17,685	12465,368	49,999
20/03/2018 05:00	1,688	420624,223	0,799	15,546	12465,368	49,999
20/03/2018 06:00	1,875	426622,033	0,822	16,023	12465,368	49,999
20/03/2018 07:00	6,347	426682,863	0,83	16,376	12465,368	49,999
20/03/2018 08:00	1,754	423021,262	0,814	17,707	12493,019	49,999
20/03/2018 09:00	1,677	426583,581	6,082	16,085	12500,98	49,959
20/03/2018 10:00	1,626	426849,482	0,806	15,947	12487,094	49,972
20/03/2018 11:00	1,657	425438,54	0,79	16,531	12469,245	49,935
20/03/2018 12:00	1,619	426875,514	0,818	16,629	12478,533	50,002
20/03/2018 13:00	1,563	427055,838	0,803	16,458	12470,868	50
20/03/2018 14:00	1,534	425587,044	0,799	16,509	12450,987	49,999
20/03/2018 15:00	1,537	427238,577	0,818	16,274	12414,75	49,955
20/03/2018 16:00	1,531	427564,813	0,816	15,87	12435,941	49,999
20/03/2018 17:00	1,575	425560,749	0,806	15,567	11969,833	47,719
20/03/2018 18:00	1,591	427882,798	0,813	16,395	12204,318	48,885
20/03/2018 19:00	4,096	397028,369	0,854	13,61	10676,499	40,762
20/03/2018 20:00	3,895	379963,582	0,887	12,312	9933,321	37,054
20/03/2018 21:00	1,745	428534,562	0,851	16,87	11861,135	46,672
20/03/2018 22:00	1,629	428432,383	0,851	15,048	12227,55	48,502
20/03/2018 23:00	1,58	424158,657	0,828	16,513	12526,843	50
21/03/2018 00:00	1,612	427176,083	0,839	16,574	12537,3	50
21/03/2018 01:00	1,647	426964,048	0,842	16,485	12546,132	49,999
21/03/2018 02:00	1,598	420749,577	0,837	16,326	12553,32	49,999
21/03/2018 03:00	1,813	423020,801	0,857	15,908	12549,431	50,003
21/03/2018 04:00	1,66	423257,714	0,871	15,533	12540,745	50,001
21/03/2018 05:00	1,709	422855,27	0,794	16,36	12485,82	49,683
21/03/2018 06:00	1,728	427257,991	0,854	18,116	12088,692	48,026
21/03/2018 07:00	7,246	427361,373	0,853	16,867	12436,129	49,585
21/03/2018 08:00	1,863	423886,914	0,839	17,79	12521,7	49,974
21/03/2018 09:00	1,678	427513,634	6,022	16,388	12261,826	48,908
21/03/2018 10:00	1,678	427495,735	0,79	16,609	12475,359	49,933
21/03/2018 11:00	1,707	425500,741	0,787	16,688	12480,907	50,004
21/03/2018 12:00	1,635	424687,748	0,8	16,549	12471,508	49,999
21/03/2018 13:00	1,667	423768,103	0,809	15,941	12107,888	48,222
21/03/2018 14:00	1,597	424997,963	0,791	15,949	12292,578	49,346
21/03/2018 15:00	1,546	428042,1	0,8	16,446	12380,172	49,701
21/03/2018 16:00	1,532	429049,447	0,792	16,515	12378,278	49,703
21/03/2018 17:00	1,526	427772,959	0,781	16,633	12443,349	49,984
21/03/2018 18:00	1,526	427749,987	0,792	16,744	12476,046	50
21/03/2018 19:00	1,524	428542,448	0,781	16,711	12500,879	50
21/03/2018 20:00	1,551	427738,172	0,774	16,679	12517,222	50,001
21/03/2018 21:00	1,561	425093,149	0,799	15,762	12518,941	50,001
21/03/2018 22:00	1,589	425096,215	0,809	15,864	12524,636	49,999
21/03/2018 23:00	1,628	421770,818	0,788	15,673	12526,734	49,997
22/03/2018 00:00	1,569	425523,894	0,806	15,679	12531,526	49,998
22/03/2018 01:00	1,654	425829,471	0,797	15,988	12520,812	50,003
22/03/2018 02:00	1,634	423533,125	0,78	15,552	12535,97	49,994
22/03/2018 03:00	1,814	426646,605	0,811	16,909	12349,105	49,026
22/03/2018 04:00	1,873	427375,502	0,827	19,81	11644,649	45,779
22/03/2018 05:00	1,646	425092,858	0,753	15,833	12521,23	49,998
22/03/2018 06:00	1,777	426937,222	0,819	16,191	12533,507	50,004
22/03/2018 07:00	7,068	427536,09	0,826	18,999	12357,211	49,205
22/03/2018 08:00	1,747	425729,614	0,79	17,187	12533,829	49,963
22/03/2018 09:00	1,671	425585,638	6,036	17,11	12511,469	49,947
22/03/2018 10:00	1,6	426012,438	0,769	15,608	12495,039	49,999
22/03/2018 11:00	1,709	424161,68	0,727	16,592	12490,074	50,001
22/03/2018 12:00	1,581	425157,483	0,79	16,402	12491,522	49,999
22/03/2018 13:00	1,623	425434,094	0,779	16,308	12433,544	49,736
22/03/2018 14:00	1,589	423938,844	0,766	16,36	12389,015	49,645

22/03/2018 15:00	1,572	426159,691	0,788	16,427	12380,252	49,7
22/03/2018 16:00	1,577	426473,786	0,786	16,511	12127,837	48,478
22/03/2018 17:00	1,518	426742,095	0,766	16,511	12427,356	50,003
22/03/2018 18:00	1,532	424993,549	0,778	16,702	12461,529	50
22/03/2018 19:00	1,564	425138,282	0,775	16,659	12503,083	49,993
22/03/2018 20:00	1,527	425049,729	0,757	16,493	12526,284	49,998
22/03/2018 21:00	1,568	424794,07	0,772	16,499	12540,585	49,999
22/03/2018 22:00	1,529	425203,135	0,788	16,223	12546,012	50,001
22/03/2018 23:00	1,534	421703,738	0,782	16,387	12550,494	49,995
23/03/2018 00:00	1,605	425798,11	0,796	15,786	12543,998	50,002
23/03/2018 01:00	1,555	425882,4	0,795	15,339	12543,574	49,999
23/03/2018 02:00	1,58	424329,121	0,769	16,011	12537,905	50
23/03/2018 03:00	1,584	425979,824	0,786	15,352	12544,601	49,998
23/03/2018 04:00	1,563	426165,039	0,815	15,313	12542,633	49,998
23/03/2018 05:00	1,65	413171,668	0,787	15,598	12528,235	49,995
23/03/2018 06:00	1,603	426001,309	0,772	15,538	12544,795	50
23/03/2018 07:00	6,651	426200,432	0,814	15,12	12542,65	49,999
23/03/2018 08:00	1,789	424701,477	0,783	14,45	12541,504	49,986
23/03/2018 09:00	1,806	423624,504	6,159	14,489	12524,241	49,979
23/03/2018 10:00	1,624	424300,389	0,81	15,645	12500,411	49,998
23/03/2018 11:00	1,606	423034,197	0,789	16,452	12494,57	49,997
23/03/2018 12:00	1,579	425781,301	0,802	16,331	12491,816	49,967
23/03/2018 13:00	1,55	426054,122	0,792	16,238	12487,09	49,969
23/03/2018 14:00	1,544	424591,269	0,788	16,517	12459,433	49,997
23/03/2018 15:00	1,5	426838,785	0,812	16,327	12437,314	49,959
23/03/2018 16:00	1,509	428524,55	0,801	16,497	12468,362	49,998
23/03/2018 17:00	1,512	427470,704	0,781	16,439	12488,916	49,997
23/03/2018 18:00	1,524	426702,393	0,792	16,237	12522,02	50
23/03/2018 19:00	1,526	426945,969	0,797	16,171	12533,278	50,004
23/03/2018 20:00	1,542	426530,465	0,785	16,274	12550,555	49,995
23/03/2018 21:00	1,56	426384,109	0,812	16,435	12563,61	50,003
23/03/2018 22:00	1,613	426500,998	0,809	16,519	12562,04	49,998
23/03/2018 23:00	1,603	422514,082	0,814	16,518	12561,245	50
24/03/2018 00:00	1,594	425834,631	0,832	16,535	12555,022	49,995
24/03/2018 01:00	1,573	426160,41	0,84	16,484	12547,396	49,998
24/03/2018 02:00	1,661	424186,302	0,797	16,123	12546,463	50
24/03/2018 03:00	1,617	425739,775	0,825	16,695	12553,075	50,001
24/03/2018 04:00	1,69	425803,72	0,836	16,308	12548,172	50,004
24/03/2018 05:00	1,59	419156,718	0,809	15,841	12550,549	49,998
24/03/2018 06:00	1,644	426341,613	0,845	15,663	12546,499	49,994
24/03/2018 07:00	6,446	426414,959	0,862	15,684	12545,893	49,985
24/03/2018 08:00	1,737	424861,77	0,785	16,604	12543,513	49,997
24/03/2018 09:00	1,637	426821,132	6,101	16,141	12533,459	50,001
24/03/2018 10:00	1,573	426982,455	0,803	16,129	12507,07	49,94
24/03/2018 11:00	1,588	425294,405	0,775	16,164	12513,885	49,989
24/03/2018 12:00	1,563	427081,443	0,793	16,075	12509,06	50,003
24/03/2018 13:00	1,566	427147,081	0,796	15,901	12446,118	49,679
24/03/2018 14:00	1,56	426365,838	0,792	15,715	12289,186	49,009
24/03/2018 15:00	1,531	427212,1	0,838	15,869	12324,249	49,38
24/03/2018 16:00	1,516	427597,792	0,823	16,044	12332,917	49,458
24/03/2018 17:00	1,503	427276,026	0,803	16,1	12383,63	49,756
24/03/2018 18:00	1,675	425084,283	0,838	16,389	12239,127	48,909
24/03/2018 19:00	1,778	427068,619	0,836	16,607	12512,664	50,001
24/03/2018 20:00	1,551	426898,182	0,837	16,12	12525,647	50
24/03/2018 21:00	1,552	427298,512	0,848	15,691	12521,141	49,971
24/03/2018 22:00	1,572	427441,024	0,848	15,517	12527,248	49,988
24/03/2018 23:00	1,624	423419,353	0,837	15,354	12531,066	50
25/03/2018 00:00	1,859	427092,48	0,874	18,93	11885,879	46,775
25/03/2018 01:00	2,157	427225,048	0,866	20,194	11767,453	46,197
25/03/2018 02:00	2,2	424366,821	0,862	20,111	11766,278	46,167
25/03/2018 03:00	2,252	425325,363	0,874	19,215	11781,007	46,196
25/03/2018 04:00	2,256	425487,8	0,869	19,421	11784,618	46,196
25/03/2018 05:00	2,109	423329,483	0,819	19,18	11589,634	45,083
25/03/2018 06:00	2,465	426636,805	0,871	19,561	11550,357	45,001
25/03/2018 07:00	7,141	426417,794	0,873	18,546	11720,19	45,965
25/03/2018 08:00	1,804	425833,915	0,821	17,09	12325,113	49,035
25/03/2018 09:00	1,669	425737,743	6,062	15,206	12516,517	50,003
25/03/2018 10:00	1,638	426061,16	0,791	15,573	12428,669	49,641
25/03/2018 11:00	1,625	425455,579	0,78	15,188	12267,15	48,976
25/03/2018 12:00	1,618	428704,029	0,785	15,501	12234,833	48,925
25/03/2018 13:00	1,586	427746,977	0,805	15,741	12240,009	49
25/03/2018 14:00	1,732	392550,333	0,836	16,503	10895,476	42,176
25/03/2018 15:00	1,53	426471,123	0,817	15,903	12202,698	49,004
25/03/2018 16:00	1,531	426629,822	0,815	15,936	12197,38	48,997
25/03/2018 17:00	1,542	426517,557	0,798	15,845	12199,495	49,002
25/03/2018 18:00	1,574	426951,28	0,803	15,764	12241,594	48,997
25/03/2018 19:00	1,636	427005,965	0,806	14,876	12285,047	49
25/03/2018 20:00	1,623	427128,495	0,797	14,965	12307,789	48,997
25/03/2018 21:00	1,616	426901,257	0,814	14,803	12320,322	48,998
25/03/2018 22:00	69,623	398430,105	0,87	14,811	11225,279	42,992
25/03/2018 23:00	101,179	2711,894	10,693	3,295	884,579	0,857
26/03/2018 00:00		0		0,045	0	-0,085
26/03/2018 01:00		0		0	0	-0,102
26/03/2018 02:00		0		0	0	-0,108
26/03/2018 03:00		0		1,662	753,642	-0,088
26/03/2018 04:00		0		0,401	0	-0,11
26/03/2018 05:00		0		0	0	-0,108
26/03/2018 06:00		0		0	0	-0,107
26/03/2018 07:00		0		0,009	0	-0,105
26/03/2018 08:00		0		0	0	-0,106
26/03/2018 09:00		0		0	0	-0,108
26/03/2018 10:00		0		0	0	-0,11
26/03/2018 11:00		0		0,011	0	-0,112
26/03/2018 12:00		0		0	0	-0,111
26/03/2018 13:00		0		0	0	-0,111
26/03/2018 14:00		0		0	0	-0,109
26/03/2018 15:00		0		0	0	-0,101
26/03/2018 16:00		0		0	0	-0,096
26/03/2018 17:00		0		0	0	-0,094
26/03/2018 18:00		0		0	0	-0,095
26/03/2018 19:00		0		0	0	-0,099
26/03/2018 20:00		0		0	0	-0,103

26/03/2018 21:00		0		0	0	-0,106
26/03/2018 22:00		0		0	0	-0,106
26/03/2018 23:00		0		0	0	-0,106
27/03/2018 00:00		0		0	0	-0,106
27/03/2018 01:00		0		0	0	-0,106
27/03/2018 02:00		0		0	0	-0,103
27/03/2018 03:00		0		0	0	-0,103
27/03/2018 04:00		0		0	0	-0,103
27/03/2018 05:00				0	0	-0,104
27/03/2018 06:00		0		0	0	-0,106
27/03/2018 07:00		0		0,002	0	-0,11
27/03/2018 08:00		0		0	0	-0,109
27/03/2018 09:00		0		0	0	-0,108
27/03/2018 10:00		0		0	0	-0,109
27/03/2018 11:00		0		0	0	-0,111
27/03/2018 12:00		0		0	0	-0,113
27/03/2018 13:00		0		0	0	-0,11
27/03/2018 14:00		0		0	0	-0,103
27/03/2018 15:00		0		0	0	-0,097
27/03/2018 16:00		0		0	0	-0,094
27/03/2018 17:00		0		0	0	-0,095
27/03/2018 18:00		0		0	0	-0,095
27/03/2018 19:00		0		0	0	-0,098
27/03/2018 20:00		0		0	0	-0,104
27/03/2018 21:00		0		0	0	-0,106
27/03/2018 22:00		0		0	0	-0,108
27/03/2018 23:00		0		0	0	-0,106
28/03/2018 00:00		0		0	0	-0,106
28/03/2018 01:00		0		0	0	-0,106
28/03/2018 02:00		0		0	0	-0,103
28/03/2018 03:00		0		0	0	-0,102
28/03/2018 04:00		0		0	0	-0,104
28/03/2018 05:00				0	0	-0,102
28/03/2018 06:00		0		0	0	-0,104
28/03/2018 07:00		0		0,001	0	-0,106
28/03/2018 08:00		0		0	0	-0,107
28/03/2018 09:00		0		0	0	-0,105
28/03/2018 10:00		0		0	0	-0,104
28/03/2018 11:00		0		0	0	-0,104
28/03/2018 12:00		0		0	0	-0,104
28/03/2018 13:00		0		0	0	-0,104
28/03/2018 14:00		0		0	0	-0,104
28/03/2018 15:00		0		0	0	-0,104
28/03/2018 16:00		0		0	0	-0,085
28/03/2018 17:00		0		0	0	-0,082
28/03/2018 18:00		0		0	0	-0,085
28/03/2018 19:00		0		0	0	-0,092
28/03/2018 20:00		0		0	0	-0,095
28/03/2018 21:00		0		0	0	-0,098
28/03/2018 22:00		0		0	0	-0,101
28/03/2018 23:00		0		0	0	-0,099
29/03/2018 00:00		0		0	0	-0,101
29/03/2018 01:00		0		0	0	-0,1
29/03/2018 02:00		0		0	0	-0,098
29/03/2018 03:00		0		0	0	-0,097
29/03/2018 04:00		0		0	0	-0,097
29/03/2018 05:00				0	0	-0,097
29/03/2018 06:00		0		0	0	-0,098
29/03/2018 07:00		0		0	0	-0,098
29/03/2018 08:00		0		0	0	-0,101
29/03/2018 09:00		0		0	0	-0,103
29/03/2018 10:00		0		0	0	-0,1
29/03/2018 11:00		0		0	0	-0,09
29/03/2018 12:00		0		0	0	-0,093
29/03/2018 13:00		0		0	0	-0,09
29/03/2018 14:00		0		0	0	-0,088
29/03/2018 15:00		0		0	0	-0,089
29/03/2018 16:00		0		0	0	-0,081
29/03/2018 17:00		0		0	0	-0,082
29/03/2018 18:00		0		0	0	-0,083
29/03/2018 19:00		0		0	0	-0,081
29/03/2018 20:00		0		0	0	-0,093
29/03/2018 21:00		0		0	0	-0,103
29/03/2018 22:00		0		0	0	-0,108
29/03/2018 23:00		0		0	0	-0,112
30/03/2018 00:00		0		0	0	-0,115
30/03/2018 01:00		0		0	0	-0,115
30/03/2018 02:00		0		0	0	-0,116
30/03/2018 03:00		0		0	0	-0,117
30/03/2018 04:00		0		0	0	-0,117
30/03/2018 05:00				0	0	-0,115
30/03/2018 06:00		0		0	0	-0,114
30/03/2018 07:00		0		0	0	-0,114
30/03/2018 08:00		0		0	0	-0,114
30/03/2018 09:00		0		0	0	-0,114
30/03/2018 10:00		0		0	187,886	-0,122
30/03/2018 11:00		0		0	197,64	-0,103
30/03/2018 12:00		0		0	0	-0,09
30/03/2018 13:00		0		0	0	-0,085
30/03/2018 14:00		0		0	0	-0,079
30/03/2018 15:00		0		0	0	-0,077
30/03/2018 16:00		0		0	0	-0,075
30/03/2018 17:00		0		0,481	2004,208	6,447
30/03/2018 18:00	12,124	0	0,523	4,751	9200,285	33,995
30/03/2018 19:00	5,545	0	5,991	2,052	2240,022	7,019
30/03/2018 20:00		0		0,131	0	-0,067
30/03/2018 21:00		0		0	0	-0,079
30/03/2018 22:00		0		0	0	-0,084
30/03/2018 23:00		0		0	0	-0,083
31/03/2018 00:00		0		0,266	1076,773	0,795
31/03/2018 01:00	194,304	0	1,141	5,294	6590,938	18,734
31/03/2018 02:00	479,505	0	0,192	12,266	7159,401	22,001

31/03/2018 03:00	485,22	194566,076	0,551	12,261	7174,528	22,002
31/03/2018 04:00	413,249	317446,305	1,012	12,362	7638,41	24,533
31/03/2018 05:00	44,852		0,902	14,797	10959,219	42,338
31/03/2018 06:00	1,709	436188,015	0,903	13,017	11901,398	46,998
31/03/2018 07:00	6,229	434808,289	0,916	12,768	11900,361	46,998
31/03/2018 08:00	1,957	431105,052	0,842	13,59	11858,091	46,706
31/03/2018 09:00		404190,175	7,817	18,769	10863,798	41,551
31/03/2018 10:00		426145,797		16,715	11530,671	45,363
31/03/2018 11:00		428347,892	0,291	16,715	11620,563	45,798
31/03/2018 12:00		427541,005	0,654	16,715	11506,08	45,181
31/03/2018 13:00	1,634	428416,321	0,802	12,096	11546,836	45,738
31/03/2018 14:00	1,544	427997,357	0,77	13,525	12094,878	48,512
31/03/2018 15:00	1,528	428910,781	0,781	13,852	12219,693	48,989
31/03/2018 16:00	1,529	428445,617	0,772	13,894	12205,475	48,92
31/03/2018 17:00	1,533	428986,867	0,755	13,94	12251,076	49,109
31/03/2018 18:00	1,535	428522,842	0,766	14,066	12343,997	49,416
31/03/2018 19:00	1,56	428993,656	0,764	14,111	12423,274	49,607
31/03/2018 20:00	1,699	429219,178	0,749	14,187	12479,932	49,827
31/03/2018 21:00	1,74	427062,233	0,789	14,195	12513,21	49,958
31/03/2018 22:00	1,735	427795,145	0,787	14,24	12527,32	49,983
31/03/2018 23:00	1,681	422425,404	0,807	14,327	12532,583	49,981
01/04/2018 00:00	1,695	422394,275	0,818	13,988	12535,173	49,999
01/04/2018 01:00	13,025	410680,312	0,828	14,8	11184,58	43,218
01/04/2018 02:00	11,516	415172,291	0,829	15,745	10719,603	41,003
01/04/2018 03:00	12,26	415052,987	0,819	15,884	10721,209	40,998
01/04/2018 04:00	17,394	416575,087	0,822	15,178	10717,041	41,002
01/04/2018 05:00	21,586	419005,247	0,826	14,62	10715,49	41
01/04/2018 06:00	15,086	421010,512	0,82	15,139	10825,553	41,607
01/04/2018 07:00	7,285	417747,992	0,787	14,197	10884,553	41,656
01/04/2018 08:00	2,311	415284,513	0,808	12,916	10764,399	41,266
01/04/2018 09:00	1,877	420700,644	8,08	13,686	11363,829	44,375
01/04/2018 10:00	1,74	428803,927	0,817	13,988	11871,876	46,882
01/04/2018 11:00	1,686	428853,159	0,826	13,149	11852,326	46,899
01/04/2018 12:00	1,658	428294,583	0,833	13,286	11839,906	46,901
01/04/2018 13:00	1,658	428344,532	0,828	13,227	11766,786	46,705
01/04/2018 14:00	1,646	428670,705	0,826	13,156	11813,471	46,886
01/04/2018 15:00	1,637	428821,579	0,831	13,13	11798,35	46,878
01/04/2018 16:00	1,662	429151,605	0,826	13,16	11808,295	46,898
01/04/2018 17:00	1,642	429311,326	0,82	13,221	11812,446	46,902
01/04/2018 18:00	3,814	419589,899	0,82	13,662	11345,761	44,365
01/04/2018 19:00	3,685	419634,089	0,832	14,059	11523,483	45,363
01/04/2018 20:00	1,68	429258,436	0,818	14,026	12254,863	48,685
01/04/2018 21:00	1,681	428207,218	0,832	14,211	12346,03	49,091
01/04/2018 22:00	1,714	428351,773	0,828	14,401	12391,392	49,305
01/04/2018 23:00	1,702	426969,685	0,82	14,452	12459,992	49,638
02/04/2018 00:00	1,942	425940,509	0,848	15,037	12094,503	47,669
02/04/2018 01:00	2,684	418922,319	0,878	16,929	10927,606	41,998
02/04/2018 02:00	3,313	420177,273	0,87	16,923	10926,766	42,003
02/04/2018 03:00	4,267	419222,674	0,878	16,681	10927,199	41,998
02/04/2018 04:00	3,724	422931,062	0,876	14,422	11406,989	44,391
02/04/2018 05:00	1,905	428636,012	0,856	12,649	11916,027	47,001
02/04/2018 06:00	1,921	430002,101	0,846	12,773	11925,093	47,002
02/04/2018 07:00	9,635	427131,308	0,812	14,315	12262,293	48,758
02/04/2018 08:00	1,844	429640,641	0,833	14,116	12520,048	49,997
02/04/2018 09:00	1,667	429808,402	6,055	13,979	12506	49,938
02/04/2018 10:00	239,743	355594,59	0,866	12,769	9417,948	33,798
02/04/2018 11:00	443,852	293879,998	0,948	11,811	7120,61	22
02/04/2018 12:00	426,945	293067,57	0,932	11,729	7103,583	21,995
02/04/2018 13:00	421,824	293573,934	0,935	11,711	7090,849	21,999
02/04/2018 14:00	411,785	292951,495	0,941	11,882	7071,616	21,996
02/04/2018 15:00	418,446	293765,329	0,958	11,761	7065,433	22,003
02/04/2018 16:00	423,308	294325,449	0,95	11,744	7065,969	22,001
02/04/2018 17:00	453,034	296495,961	0,941	11,531	7086,251	22,002
02/04/2018 18:00	133,2	389538,147	0,852	13,381	10400,751	39,579
02/04/2018 19:00	96,922	364484,744	0,873	12,055	9411,482	34,257
02/04/2018 20:00	146,393	344818,128	0,905	11,248	8569,865	30,003
02/04/2018 21:00	98,508	377715,596	0,879	12,57	9852,08	36,56
02/04/2018 22:00	31,867	399932,464	0,831	12,678	10711,278	40,817
02/04/2018 23:00	27,853	372339,082	0,866	9,772	9528,763	35,105
03/04/2018 00:00	7,689	423209,829	0,827	14,2	11464,911	44,776
03/04/2018 01:00	1,891	431848,87	0,803	13,356	12024,143	47,498
03/04/2018 02:00	1,896	428967,546	0,822	13,34	12023,104	47,499
03/04/2018 03:00	4,857	404549,13	0,833	13,406	10736,074	41,048
03/04/2018 04:00	5,074	389269,15	0,842	11,966	10144,578	38,003
03/04/2018 05:00	5,015	387235,34	0,843	12,048	10132,026	38,002
03/04/2018 06:00	170,63	362542,518	0,852	12,084	9216,757	32,766
03/04/2018 07:00	552,077	302847,559	0,89	11,703	7275,122	22,002
03/04/2018 08:00	416,594	318332,703	0,932	11,71	7758,806	24,991
03/04/2018 09:00	112,649	347705,635	6,655	10,858	8734,513	30,893
03/04/2018 10:00	22,187	381515,739	0,935	11,25	9880,959	36,964
03/04/2018 11:00	3,604	423281,841	0,881	13,068	11744,539	46,378
03/04/2018 12:00	1,701	432829,37	0,884	13,468	12140,652	48,317
03/04/2018 13:00	1,676	430905,796	0,882	13,653	11924,936	47,357
03/04/2018 14:00	1,628	430831,907	0,886	13,634	12096,458	48,253
03/04/2018 15:00	1,621	431341,222	0,877	13,56	12090,623	48,28
03/04/2018 16:00	1,599	432007,419	0,877	13,904	12144,2	48,577
03/04/2018 17:00	1,594	432038,375	0,878	13,536	12114,698	48,345
03/04/2018 18:00	1,609	431519,867	0,886	13,838	12197,366	48,629
03/04/2018 19:00	1,656	431546,804	0,887	14,009	12232,71	48,661
03/04/2018 20:00	1,724	430945,441	0,891	14,112	12313,364	48,985
03/04/2018 21:00	1,624	430120,652	0,891	14,166	12370,154	49,22
03/04/2018 22:00	1,748	430086,235	0,895	13,93	12261,135	48,634
03/04/2018 23:00	1,797	427060,695	0,935	13,737	12118,727	48,002
04/04/2018 00:00	1,804	424179,953	0,932	13,76	12121,925	47,999
04/04/2018 01:00	1,771	425066,448	0,941	13,781	12123,741	47,999
04/04/2018 02:00	1,785	427797,58	0,925	13,881	12125,207	47,997
04/04/2018 03:00	1,894	428833,696	0,915	13,847	12130,671	48,003
04/04/2018 04:00	1,892	428974,019	0,925	13,746	12120,62	48,001
04/04/2018 05:00	1,717	432316,467	0,917	13,585	12105,093	48,002
04/04/2018 06:00	13,544	422699,507	0,932	13,955	11445,848	44,53
04/04/2018 07:00	6,554	429877,66	0,872	14,214	12534,623	49,992
04/04/2018 08:00	1,862	429641,415	0,889	14,245	12527,931	50,002

04/04/2018 09:00	1,747	430235,094	6,059	14,1	12514,597	50,003
04/04/2018 10:00	1,661	431631,317	0,796	14,104	12444,326	49,661
04/04/2018 11:00	27,779	416135,238	0,833	13,476	11282,262	43,724
04/04/2018 12:00	201,894	318297,013	0,954	11,761	8023,896	27,127
04/04/2018 13:00	46,292	334781,378	0,933	11,417	8515,386	29,999
04/04/2018 14:00	6,724	415254,688	0,843	13,472	11410,463	44,813
04/04/2018 15:00	9,565	411969,283	0,843	12,792	11320,908	44,335
04/04/2018 16:00	1,632	430841,958	0,811	12,992	12046,025	48,016
04/04/2018 17:00	1,609	430624,68	0,81	13,336	12106,992	48,285
04/04/2018 18:00	1,619	429504,335	0,814	13,78	12193,602	48,597
04/04/2018 19:00	1,62	428565,193	0,811	13,927	12267,216	48,768
04/04/2018 20:00	1,665	428321,623	0,816	13,594	12120,333	48,012
04/04/2018 21:00	1,656	427296,079	0,826	13,793	12224,213	48,498
04/04/2018 22:00	1,69	427551,193	0,826	13,828	12232,946	48,497
04/04/2018 23:00	1,755	429916,345	0,827	13,864	12229,131	48,501
05/04/2018 00:00	1,912	428528,146	0,832	13,975	12225,301	48,498
05/04/2018 01:00	1,806	428664,018	0,832	14,014	12221,16	48,497
05/04/2018 02:00	1,764	429259,551	0,824	13,985	12232,599	48,499
05/04/2018 03:00	1,678	428029,839	0,82	14	12362,65	49,213
05/04/2018 04:00	1,757	428452,716	0,832	14,135	12423,262	49,499
05/04/2018 05:00	1,785	430661,172	0,817	14,23	12406,702	49,5
05/04/2018 06:00	1,833	429399,715	0,829	14,142	12438,884	49,562
05/04/2018 07:00	6,01	429800,915	0,785	14,2	12538,651	49,995
05/04/2018 08:00	1,736	429599,929	0,81	14,09	12528,98	49,998
05/04/2018 09:00	3,923	415397,829	6,273	13,731	11790,997	46,268
05/04/2018 10:00	1,858	408041,037	0,89	14,387	11217,713	43,66
05/04/2018 11:00	1,658	427534,863	0,86	14,092	12343,208	49,112
05/04/2018 12:00	1,672	427789,337	0,875	13,848	12187,362	48,474
05/04/2018 13:00	6,639	387834,38	0,911	11,315	10267,889	39,049
05/04/2018 14:00	1,649	429708,514	0,871	13,51	12057,624	47,999
05/04/2018 15:00	1,611	430831,63	0,868	13,529	12050,426	48
05/04/2018 16:00	13,26	392603,445	0,916	11,83	10389,107	39,303
05/04/2018 17:00	6,907	401344,203	0,919	14,563	10608,163	40,004
05/04/2018 18:00	5,714	406357,286	0,923	14,274	10759,886	41,045
05/04/2018 19:00	1,643	430832,102	0,879	13,847	12210,671	48,745
05/04/2018 20:00	1,671	429808,541	0,871	14,103	12296,773	49,018
05/04/2018 21:00	1,684	426659,505	0,897	14,278	12408,552	49,536
05/04/2018 22:00	1,705	426878,991	0,894	14,285	12447,284	49,667
05/04/2018 23:00	1,728	428707,373	0,878	14,395	12453,894	49,671
06/04/2018 00:00	1,665	428548,709	0,886	14,427	12476,304	49,782
06/04/2018 01:00	1,66	428711,317	0,878	14,385	12447,502	49,718
06/04/2018 02:00	1,685	427625,379	0,887	14,371	12463,998	49,837
06/04/2018 03:00	1,674	426365,933	0,865	14,477	12498,352	49,981
06/04/2018 04:00	1,65	426638,267	0,859	14,589	12453,014	49,774
06/04/2018 05:00	1,689	427303,363	0,882	14,618	12450,922	49,843
06/04/2018 06:00	1,812	429278,589	0,875	14,503	12482,397	49,98
06/04/2018 07:00	7,133	428558,455	0,833	14,426	12481,436	50,001
06/04/2018 08:00	1,737	429614,248	0,859	14,361	12470,938	49,996
06/04/2018 09:00	1,704	428970,884	6,141	14,175	12466,094	49,999
06/04/2018 10:00	1,662	427960,685	0,849	14,199	12438,399	50
06/04/2018 11:00	1,637	428862,693	0,846	14,458	12400,002	49,957
06/04/2018 12:00		430734,976	0,812	16,384	12359,29	49,766
06/04/2018 13:00	1,658	430243,772	0,803	14,462	12297,951	49,575
06/04/2018 14:00	1,599	429728,234	0,843	14,534	12342,919	49,801
06/04/2018 15:00	1,576	430529,535	0,836	14,603	12387,51	49,958
06/04/2018 16:00	1,572	429916,319	0,838	14,66	12394,718	49,957
06/04/2018 17:00	1,561	431256,806	0,841	14,62	12398,721	49,994
06/04/2018 18:00	1,588	429546,174	0,828	14,64	12395,513	49,997
06/04/2018 19:00	1,625	431125,907	0,867	14,92	12376,175	49,903
06/04/2018 20:00	1,634	429340,629	0,868	14,554	12380,983	50,003
06/04/2018 21:00	1,657	427032,338	0,851	14,614	12380,628	49,999
06/04/2018 22:00	1,607	427197,301	0,869	14,585	12378,382	50,004
06/04/2018 23:00	1,665	427762,549	0,852	14,614	12378,706	50,003
07/04/2018 00:00	1,642	427840,402	0,855	14,613	12385,877	50,001
07/04/2018 01:00	1,649	427770,516	0,846	14,717	12383,436	50,004
07/04/2018 02:00	1,66	428692,529	0,849	14,667	12379,903	50,001
07/04/2018 03:00	1,688	426755,667	0,854	14,667	12375,357	49,999
07/04/2018 04:00	1,677	427894,041	0,851	14,634	12377,906	50,002
07/04/2018 05:00	1,654	428646,462	0,865	14,591	12379,854	50,001
07/04/2018 06:00	1,657	430102,886	0,856	14,615	12372,701	50,004
07/04/2018 07:00	1,845	429758,758	0,858	14,688	12370,861	50,003
07/04/2018 08:00	1,801	429713,094	0,853	14,619	12374,895	50,004
07/04/2018 09:00	1,808	428899,606	6,187	14,588	12368,02	50
07/04/2018 10:00	1,719	429625,254	0,839	14,718	12350,735	49,926
07/04/2018 11:00	1,792	429659,292	0,833	14,639	12287,787	49,588
07/04/2018 12:00	1,812	429938,305	0,839	14,368	12121,917	48,869
07/04/2018 13:00	1,655	429583,987	0,848	14,389	12105,13	48,882
07/04/2018 14:00	1,637	426844,229	0,839	14,392	12047,606	48,683
07/04/2018 15:00	1,612	427858,662	0,857	14,47	12059,658	48,82
07/04/2018 16:00	1,607	430067,593	0,85	14,442	12046,411	48,716
07/04/2018 17:00	1,622	429479,547	0,842	14,311	12059,313	48,692
07/04/2018 18:00	1,615	430520,64	0,828	14,394	12174,811	49,135
07/04/2018 19:00	1,668	430548,38	0,831	14,564	12277,569	49,465
07/04/2018 20:00	1,822	430625,238	0,846	14,63	12336,537	49,694
07/04/2018 21:00	1,753	430136,883	0,862	14,768	12362,514	49,738
07/04/2018 22:00	1,934	429389,011	0,868	14,857	12380,635	49,826
07/04/2018 23:00	1,985	430568,686	0,865	14,958	12276,324	49,236
08/04/2018 00:00	1,806	428434,208	0,862	14,428	12366,336	49,757
08/04/2018 01:00	1,7	429462,151	0,863	14,325	12386,987	49,807
08/04/2018 02:00	1,698	429801,71	0,878	14,445	12380,841	49,812
08/04/2018 03:00	1,795	429005,163	0,873	14,432	12389,56	49,807
08/04/2018 04:00	2,196	429252,993	0,885	16,419	11483,821	45,12
08/04/2018 05:00	2,041	417654,229	0,903	17,371	11302,117	44,297
08/04/2018 06:00	2,191	428909,165	0,899	17,274	11302,835	44,302
08/04/2018 07:00	2,198	429626,549	0,896	17,405	11576,826	45,867
08/04/2018 08:00	1,862	427898,601	0,872	14,507	12415,761	49,995
08/04/2018 09:00	1,703	428039,626	6,144	14,341	12406,006	49,999
08/04/2018 10:00	1,666	427839,734	0,834	14,469	12322,838	49,613
08/04/2018 11:00	1,672	429249,043	0,806	14,313	12198,504	49,02
08/04/2018 12:00	1,676	426355,508	0,837	14,216	12149,099	48,806
08/04/2018 13:00	1,723	427817,074	0,838	14,127	12075,157	48,538
08/04/2018 14:00	1,672	427372,852	0,844	14,271	12095,618	48,736

08/04/2018 15:00	1,633	427049,316	0,839	14,3	12013,378	48,421
08/04/2018 16:00	1,618	427939,821	0,832	14,357	12109,791	48,882
08/04/2018 17:00	1,604	427133,812	0,821	14,448	12146,159	49,014
08/04/2018 18:00	1,624	428085,261	0,817	14,46	12183,631	49,054
08/04/2018 19:00	1,661	428041,538	0,828	14,521	12233,352	49,15
08/04/2018 20:00	1,651	427761,372	0,833	14,542	12340,697	49,651
08/04/2018 21:00	1,639	428775,284	0,843	14,568	12377,262	49,787
08/04/2018 22:00	1,735	427881,815	0,841	14,51	12423,837	49,964
08/04/2018 23:00	1,736	428249,98	0,846	14,575	12432,335	49,991
09/04/2018 00:00	1,736	425883,246	0,848	14,764	12429,931	49,95
09/04/2018 01:00	1,691	426638,066	0,851	14,534	12437,88	49,995
09/04/2018 02:00	1,919	426653,016	0,845	14,498	12433,367	50
09/04/2018 03:00	1,896	425801,792	0,862	14,476	12434,315	49,999
09/04/2018 04:00	1,874	425176,825	0,86	14,497	12434,076	50,003
09/04/2018 05:00	50,208	420183,252	0,888	13,856	11398,064	44,892
09/04/2018 06:00	1,865	428523,688	0,834	14,617	12436,245	49,997
09/04/2018 07:00	2,031	429836,56	0,834	14,585	12442,544	50,001
09/04/2018 08:00	1,819	428365,198	0,836	14,366	12440,819	50
09/04/2018 09:00	1,754	429581,093	6,186	14,226	12434,66	50,003
09/04/2018 10:00	1,688	428102,266	0,837	14,276	12417,152	49,97
09/04/2018 11:00	1,669	429323,563	0,858	14,451	12365,216	49,72
09/04/2018 12:00	1,672	428169,856	0,848	14,376	12298,141	49,387
09/04/2018 13:00	1,628	428405,375	0,863	14,317	12261,975	49,246
09/04/2018 14:00	1,614	428461,951	0,855	14,287	12225,601	49,108
09/04/2018 15:00	1,607	426891,128	0,861	14,32	12250,233	49,346
09/04/2018 16:00	1,609	427228,395	0,847	14,474	12320,689	49,631
09/04/2018 17:00	1,633	426779,424	0,848	14,629	12368,031	49,742
09/04/2018 18:00	1,634	425325,743	0,857	14,677	12384,769	49,688
09/04/2018 19:00	1,673	424638,973	0,848	14,768	12397,053	49,71
09/04/2018 20:00	1,691	423212,114	0,856	14,813	12445,827	49,907
09/04/2018 21:00	1,72	426977,985	0,851	14,628	12468,506	49,995
09/04/2018 22:00	1,694	427714,54	0,875	14,42	12466,144	49,999
09/04/2018 23:00	1,891	428390,594	0,852	14,469	12460,895	49,998
10/04/2018 00:00	4,388	428047,833	0,897	15,286	11708,599	46,199
10/04/2018 01:00	5,874	428663,536	0,902	15,421	11469,52	45,103
10/04/2018 02:00	3,698	428268,447	0,902	15,7	11593,669	45,752
10/04/2018 03:00	4,149	428165,781	0,9	15,87	11609,665	45,801
10/04/2018 04:00	2,712	427313,172	0,89	15,063	12238,299	48,895
10/04/2018 05:00	1,76	424910,913	0,867	14,645	12447,038	49,997
10/04/2018 06:00	1,751	427252,993	0,883	14,551	12468,468	49,997
10/04/2018 07:00	1,857	427480,412	0,897	14,537	12471,936	50,001
10/04/2018 08:00	1,849	427843,155	0,889	14,489	12467,837	50,001
10/04/2018 09:00	1,768	427711,941	6,288	14,405	12462,253	50,001
10/04/2018 10:00	1,729	428000,273	0,857	14,325	12449,335	49,998
10/04/2018 11:00	1,625	428427,357	0,856	14,398	12411,48	49,892
10/04/2018 12:00	1,617	428652,746	0,853	14,394	12339,676	49,572
10/04/2018 13:00	1,606	428685,232	0,854	14,354	12324,84	49,499
10/04/2018 14:00	1,625	427722,051	0,856	14,391	12313,773	49,385
10/04/2018 15:00	1,632	427077,38	0,86	14,348	12301,297	49,323
10/04/2018 16:00	1,626	426752,564	0,866	14,349	12294,438	49,265
10/04/2018 17:00	1,772	426986,06	0,866	14,371	12308,601	49,323
10/04/2018 18:00	1,72	427613,495	0,885	14,44	12313,654	49,36
10/04/2018 19:00	1,772	428123,117	0,866	14,514	12314,04	49,288
10/04/2018 20:00	1,678	425915,979	0,858	14,456	12289,643	49,126
10/04/2018 21:00	1,628	427179,564	0,871	14,513	12335,893	49,428
10/04/2018 22:00	1,637	426796,828	0,863	14,646	12381,517	49,582
10/04/2018 23:00	1,624	428912,431	0,865	14,62	12413,019	49,774
11/04/2018 00:00	1,624	428374,751	0,85	14,726	12433,892	49,864
11/04/2018 01:00	1,67	428617,068	0,891	14,752	12392,519	49,645
11/04/2018 02:00	1,621	429091,74	0,88	14,641	12284,895	49,035
11/04/2018 03:00	1,798	429340,593	0,91	15,094	11467,499	45,001
11/04/2018 04:00	1,904	428848,049	0,886	15,765	11466,841	45,001
11/04/2018 05:00	2,004	428306,866	0,907	15,144	11452,434	45,092
11/04/2018 06:00	1,746	427917,174	0,898	14,513	12457,823	49,951
11/04/2018 07:00	1,971	428234,263	0,889	14,393	12470,642	49,998
11/04/2018 08:00	1,876	428159,915	0,887	14,289	12471,293	50
11/04/2018 09:00	1,729	427080,754	6,207	14,192	12463,536	50,004
11/04/2018 10:00	1,696	429277,962	0,841	14,531	12396,696	49,717
11/04/2018 11:00	1,675	431134,937	0,858	14,219	12195,897	48,778
11/04/2018 12:00	1,66	431958,045	0,881	14,252	12182,94	48,813
11/04/2018 13:00	1,655	432106,825	0,857	14,238	12166,876	48,732
11/04/2018 14:00	1,623	432040,035	0,851	14,207	12153,753	48,708
11/04/2018 15:00	1,61	431839,812	0,847	14,265	12247,82	49,169
11/04/2018 16:00	1,607	430778,409	0,857	14,273	12194,379	48,834
11/04/2018 17:00	1,694	431032,889	0,863	14,114	11614,061	45,874
11/04/2018 18:00	1,935	427736,571	0,864	14,436	11949,574	47,712
11/04/2018 19:00	1,634	428504,895	0,859	14,709	12415,659	49,803
11/04/2018 20:00	1,621	425480,506	0,848	14,645	12460,911	49,979
11/04/2018 21:00	1,64	429702,493	0,848	14,677	12448,565	49,864
11/04/2018 22:00	1,633	430348,197	0,887	14,513	12479,717	50
11/04/2018 23:00	1,636	430500,272	0,874	14,484	12479,286	50,001
12/04/2018 00:00	1,668	428837,747	0,879	14,56	12477,238	49,996
12/04/2018 01:00	1,651	428701,631	0,883	14,641	12478,998	50
12/04/2018 02:00	1,736	429679,228	0,875	14,871	12477,268	50
12/04/2018 03:00	1,766	428778,333	0,886	15,574	12342,396	49,218
12/04/2018 04:00	1,833	429202,189	0,871	15,998	12060,337	48,087
12/04/2018 05:00	1,861	403609,134	0,871	15,937	12146,557	48,443
12/04/2018 06:00	2,33	430905,912	0,86	16,067	12132,246	48,238
12/04/2018 07:00	2,099	430862,017	0,862	15,937	12174,339	48,444
12/04/2018 08:00	1,916	430801,168	0,855	15,289	12232,317	48,715
12/04/2018 09:00	1,826	430064,193	6,19	14,713	11977,352	47,453
12/04/2018 10:00	1,78	428850,44	0,788	14,261	11739,779	46,402
12/04/2018 11:00	1,823	427204,274	0,836	14,119	11449,974	45,099
12/04/2018 12:00	1,818	428932,503	0,869	13,726	11445,816	45,163
12/04/2018 13:00	1,808	428355,907	0,859	13,553	11390,203	44,901
12/04/2018 14:00		424774,505	0,847	13,481	11265,179	44,852
12/04/2018 15:00	1,721	428776,711	0,859	13,508	11340,155	44,802
12/04/2018 16:00	1,718	429210,971	0,851	13,537	11335,531	44,858
12/04/2018 17:00	1,719	429658,04	0,843	13,593	11381,164	45,044
12/04/2018 18:00	1,784	428112,385	0,85	13,687	11421,102	45,057
12/04/2018 19:00	1,841	428280,681	0,849	13,832	11477,91	45,159
12/04/2018 20:00	1,854	428249,743	0,863	14,056	11549,158	45,479

12/04/2018 21:00	1,805	429825,392	0,868	14,138	11596,933	45,665
12/04/2018 22:00	1,912	429319,521	0,868	14,262	11630,014	45,817
12/04/2018 23:00	1,834	427561,636	0,889	14,477	11699,455	46,224
13/04/2018 00:00	1,872	427189,167	0,877	14,573	11725,831	46,299
13/04/2018 01:00	1,89	427150,058	0,869	14,601	11728,662	46,321
13/04/2018 02:00	1,824	427437,737	0,878	14,752	11784,277	46,628
13/04/2018 03:00	1,932	426568,273	0,873	14,812	11821,248	46,718
13/04/2018 04:00	1,922	426759,852	0,868	14,966	11844,795	46,902
13/04/2018 05:00	2,022	427794,265	0,866	15,174	11916,034	47,32
13/04/2018 06:00	2,101	429288,48	0,863	15,103	11884,073	47,006
13/04/2018 07:00	5,227	429088,698	0,822	15,283	11962,859	47,424
13/04/2018 08:00	1,948	428811,782	0,859	14,866	12033,552	47,72
13/04/2018 09:00	1,875	429229,31	2,546	14,312	11865,931	46,923
13/04/2018 10:00	1,856	429744,382	4,402	14,054	11663,508	46,027
13/04/2018 11:00	1,945	428920,809	0,821	13,807	11514,195	45,339
13/04/2018 12:00	1,886	425652,722	0,811	13,487	11435,148	44,983
13/04/2018 13:00	1,71	428794,656	0,802	13,909	12187,747	48,801
13/04/2018 14:00	1,725	428437,089	0,8	13,784	12136,611	48,61
13/04/2018 15:00	1,685	428758,14	0,797	13,799	12120,701	48,62
13/04/2018 16:00	1,656	427689,277	0,79	14,049	12197,431	48,998
13/04/2018 17:00	1,65	428154,58	0,779	14,218	12264,238	49,244
13/04/2018 18:00	1,663	426519,946	0,791	14,23	12378,358	49,659
13/04/2018 19:00	1,736	426433,466	0,788	14,399	12426,7	49,766
13/04/2018 20:00	1,831	426607,72	0,805	14,47	12460,9	49,865
13/04/2018 21:00	1,834	426893,423	0,818	14,42	12499,192	49,971
13/04/2018 22:00	1,808	427080,709	0,818	14,419	12510,587	49,986
13/04/2018 23:00	1,789	426911,343	0,814	14,161	12513,596	49,999
14/04/2018 00:00	1,957	426968,271	0,821	14,295	12509,922	49,997
14/04/2018 01:00	1,873	427115,582	0,809	14,36	12505,993	50
14/04/2018 02:00	1,894	427603,687	0,802	14,352	12518,137	49,998
14/04/2018 03:00	1,904	427588,199	0,792	14,32	12524,219	49,999
14/04/2018 04:00	1,861	427550,85	0,809	14,358	12526,949	50,002
14/04/2018 05:00	1,878	426698,555	0,806	14,396	12527,097	49,999
14/04/2018 06:00	1,81	423394,248	0,822	14,482	12523,221	50
14/04/2018 07:00	5,722	424047,511	0,78	14,411	12515,968	50
14/04/2018 08:00	2,033	424288,31	0,806	14,207	12504,721	49,997
14/04/2018 09:00	1,924	427102,944	0,796	14,075	12493,296	50,001
14/04/2018 10:00	1,813	427655,489	6,026	14,28	12368,175	49,335
14/04/2018 11:00	1,819	427964,576	0,807	14,18	12142,008	48,493
14/04/2018 12:00	1,827	427564,934	0,815	13,984	12210,779	48,812
14/04/2018 13:00	1,752	427821,72	0,809	13,683	12149,836	48,537
14/04/2018 14:00	1,696	427939,43	0,81	13,865	11990,739	47,8
14/04/2018 15:00	1,692	427502,124	0,812	13,807	12066,811	48,332
14/04/2018 16:00	1,681	427356,853	0,808	13,824	12065,62	48,33
14/04/2018 17:00	1,696	427297,488	0,801	13,91	12115,428	48,537
14/04/2018 18:00	1,757	427926,974	0,795	14,058	12201,194	48,76
14/04/2018 19:00	1,828	427553,345	0,8	14,135	12244,865	48,844
14/04/2018 20:00	1,74	427405,705	1,249	14,279	12322,557	49,195
14/04/2018 21:00	1,813	425645,589	0,852	14,687	12430,662	49,71
14/04/2018 22:00	1,801	426641,392	0,84	14,626	12436,573	49,749
14/04/2018 23:00	1,96	426891,769	0,846	14,63	12478,659	49,94
15/04/2018 00:00	1,793	426502,645	0,822	14,528	12488,733	49,928
15/04/2018 01:00	1,869	427689,223	0,828	13,474	11981,916	47,419
15/04/2018 02:00	2,066	427148,523	0,862	13,733	11881,099	47
15/04/2018 03:00	2,196	427228,63	0,853	13,339	11885,846	46,996
15/04/2018 04:00	2,091	427850,551	0,84	12,966	11898,105	47,001
15/04/2018 05:00	2,25	425145,018	0,859	13,629	11888,146	46,999
15/04/2018 06:00	2,391	427246,787	0,847	13,237	11893,565	47
15/04/2018 07:00	5,601	427657,593	0,798	14,361	11903,93	46,993
15/04/2018 08:00	1,945	427205,852	0,835	14,555	12292,497	49,057
15/04/2018 09:00	1,769	426987,605	0,821	14,407	12471,576	49,991
15/04/2018 10:00	1,805	426320,486	6,125	14,452	12441,014	49,949
15/04/2018 11:00	1,761	426769,183	0,813	14,362	12253,014	49,107
15/04/2018 12:00	1,773	426967,678	0,817	14,102	12116,327	48,439
15/04/2018 13:00	1,778	426883,858	0,815	14,125	12136,083	48,644
15/04/2018 14:00	1,788	425622,935	0,823	13,947	11863,514	47,316
15/04/2018 15:00	1,745	426943,988	0,808	13,984	12055,386	48,27
15/04/2018 16:00	1,74	428214,719	0,81	14,123	12114,8	48,561
15/04/2018 17:00	1,753	427239,699	0,805	14,327	12190,398	48,813
15/04/2018 18:00	1,773	427557,307	0,806	14,208	12194,364	48,681
15/04/2018 19:00	1,899	428272,988	0,805	14,398	12272,897	48,98
15/04/2018 20:00	1,854	427451,23	0,817	14,426	12359,549	49,381
15/04/2018 21:00	1,771	426391,268	0,811	14,554	12453,185	49,793
15/04/2018 22:00	1,801	426950,632	0,821	14,614	12492,796	49,98
15/04/2018 23:00	1,964	427425,668	0,818	14,395	12496,97	49,998
16/04/2018 00:00	1,846	426397,184	0,822	14,317	12501,992	49,996
16/04/2018 01:00	2,027	426541,441	0,819	14,373	12499,878	49,998
16/04/2018 02:00	1,963	425848,539	0,832	14,477	12498,297	49,999
16/04/2018 03:00	1,914	426802,052	0,804	14,393	12499,495	49,998
16/04/2018 04:00	1,812	426622,42	0,818	14,433	12495,625	49,995
16/04/2018 05:00	2,045	424799,11	0,806	14,547	12482,265	49,997
16/04/2018 06:00	2,101	426310,796	0,825	14,549	12494,016	49,998
16/04/2018 07:00	5,315	426254,061	0,807	14,814	12486,592	50
16/04/2018 08:00	1,923	426375,575	0,829	14,474	12479,064	49,987
16/04/2018 09:00	1,887	426332,518	0,825	14,283	12460,598	49,947
16/04/2018 10:00	1,833	426418,901	6,147	14,299	12447,887	49,953
16/04/2018 11:00	1,812	426855,093	0,845	14,406	12337,369	49,382
16/04/2018 12:00	1,796	426822,819	0,845	14,18	12266,341	49,107
16/04/2018 13:00	1,706	427231,144	0,839	14,276	12291,966	49,262
16/04/2018 14:00	1,722	428739,716	0,846	14,18	12137,535	48,522
16/04/2018 15:00	1,688	428416,945	0,836	14,233	12246,246	49,05
16/04/2018 16:00	1,764	428534,111	0,835	13,762	12082,488	48,104
16/04/2018 17:00	2,054	421027,208	0,863	14,402	11270,163	44,09
16/04/2018 18:00	1,823	425706,773	0,854	14,252	11865,369	47,104
16/04/2018 19:00	1,802	425694,106	0,855	14,449	12348,51	49,322
16/04/2018 20:00	1,887	425754,826	0,868	14,563	12447,574	49,794
16/04/2018 21:00	1,889	426522,37	0,867	13,643	12077,457	47,928
16/04/2018 22:00	2,046	427053,297	0,875	13,151	11889,479	46,997
16/04/2018 23:00	1,906	427607,599	0,864	13,435	11893,408	47,002
17/04/2018 00:00	2,08	426907,88	0,876	12,986	11891,392	47
17/04/2018 01:00	1,889	426832,935	0,887	12,965	11892,159	47,006
17/04/2018 02:00	1,933	426849,334	0,865	12,99	11889,642	47,004

17/04/2018 03:00	1,867	426277,139	0,866	12,949	11890,205	47,005
17/04/2018 04:00	1,915	426756,982	0,865	13,155	11888,391	47,002
17/04/2018 05:00	1,949	422933,174	0,853	13,57	11879,889	47,005
17/04/2018 06:00	2,137	427804,297	0,861	13,192	11898,991	47,001
17/04/2018 07:00	5,127	427876,824	0,84	13,708	11897,901	46,997
17/04/2018 08:00	2,281	427720,432	0,894	12,784	11886,489	46,997
17/04/2018 09:00	2,026	427327,816	0,886	12,408	11871,338	46,997
17/04/2018 10:00	1,88	429014,381	6,15	13,028	11862,47	46,999
17/04/2018 11:00	1,835	429520,072	0,832	13,513	11858,198	47
17/04/2018 12:00	1,809	429800,655	0,841	13,515	11844,689	46,995
17/04/2018 13:00	1,773	428973,663	0,841	13,491	11835,313	46,979
17/04/2018 14:00	1,741	428715,998	0,841	13,687	11795,12	46,837
17/04/2018 15:00	1,775	429036,716	0,842	14,221	11493,397	45,46
17/04/2018 16:00	1,728	429960,274	0,845	13,7	11793,674	47,001
17/04/2018 17:00	1,741	428363,542	0,843	13,699	11809,204	47,002
17/04/2018 18:00	1,781	428365,329	0,832	13,695	11846,079	46,998
17/04/2018 19:00	1,89	428166,749	0,824	13,671	11869,812	47
17/04/2018 20:00	1,803	428298,655	0,843	13,59	11880,258	47,002
17/04/2018 21:00	1,793	428294,837	0,856	13,47	11884,105	46,998
17/04/2018 22:00	1,867	428270,907	0,867	13,073	11881,944	46,998
17/04/2018 23:00	1,903	427550,176	0,887	12,992	11875,623	47,001
18/04/2018 00:00	1,924	426224,838	0,868	13,085	11923,693	47,262
18/04/2018 01:00	1,975	426616,416	0,862	14,002	12094,702	47,998
18/04/2018 02:00	1,913	426367,002	0,878	13,646	12088,83	47,998
18/04/2018 03:00	1,994	427767,527	0,87	13,641	12080,308	47,999
18/04/2018 04:00	1,98	427689,633	0,855	13,619	12083,78	47,996
18/04/2018 05:00	1,871	424737,635	0,864	13,679	12073,603	48,005
18/04/2018 06:00	2,03	430040,671	0,852	13,678	12087,046	48,05
18/04/2018 07:00	6,149	428498,748	0,814	14,432	12492,807	50
18/04/2018 08:00	2,01	429211,305	0,861	14,457	12476,931	49,986
18/04/2018 09:00	1,88	427251,944	0,843	14,257	12473,79	49,989
18/04/2018 10:00	1,827	427788,179	6,113	14,379	12242,304	48,861
18/04/2018 11:00	1,846	427394,613	0,832	14,401	12300,916	49,262
18/04/2018 12:00	1,886	426872,666	0,821	14,082	12192,539	48,729
18/04/2018 13:00	1,807	426134,843	0,826	14,009	12152,598	48,635
18/04/2018 14:00	1,735	427414,237	0,821	14,017	12077,662	48,375
18/04/2018 15:00	1,718	426520,48	0,829	14,131	12125,428	48,585
18/04/2018 16:00	1,722	426906,362	0,818	13,793	12102,646	48,425
18/04/2018 17:00	1,742	426760,557	0,799	13,796	12127,569	48,486
18/04/2018 18:00	1,746	427828,154	0,801	14,269	12234,539	48,896
18/04/2018 19:00	1,76	428382,555	0,804	14,361	12307,808	49,179
18/04/2018 20:00	1,808	428437,898	0,815	14,437	12362,427	49,415
18/04/2018 21:00	1,773	425752,396	0,828	14,495	12441,431	49,823
18/04/2018 22:00	1,808	427216,285	0,838	14,388	12467,199	49,921
18/04/2018 23:00	1,83	426517,834	0,841	14,373	12488,647	49,998
19/04/2018 00:00	1,807	425453,052	0,862	14,43	12497,684	49,993
19/04/2018 01:00	1,801	425859,242	0,86	14,322	12496,503	50
19/04/2018 02:00	1,956	426589,041	0,859	14,433	12440,937	49,671
19/04/2018 03:00	1,932	427846,998	0,879	15,418	11975,118	47,472
19/04/2018 04:00	1,843	428131,769	0,84	14,57	12291,156	49
19/04/2018 05:00	1,966	428106,57	0,842	14,607	12279,215	48,994
19/04/2018 06:00	2,009	430248,463	0,86	14,588	12342,797	49,287
19/04/2018 07:00	5,7	429805,035	0,826	14,364	12501,849	50
19/04/2018 08:00	1,874	431220,459	0,846	14,243	12491,498	49,995
19/04/2018 09:00	1,942	430772,076	0,836	14,245	12480,121	49,974
19/04/2018 10:00	1,882	432467,93	0,877	14,182	12461,246	49,997
19/04/2018 11:00	1,857	432001,593	0,854	14,372	12332,207	49,38
19/04/2018 12:00	1,915	432065,054	0,863	14,321	12255,745	49,02
19/04/2018 13:00	1,844	431761,241	0,868	14,154	12153,713	48,621
19/04/2018 14:00	1,795	432986,594	0,862	14,11	12080,13	48,434
19/04/2018 15:00	1,742	432973,499	0,86	14,18	12113,51	48,616
19/04/2018 16:00	1,735	432982,083	0,861	14,267	12145,542	48,759
19/04/2018 17:00	1,793	432861,345	0,857	14,259	12165,248	48,779
19/04/2018 18:00	1,841	432743,688	0,852	14,4	12251,237	49,045
19/04/2018 19:00	1,877	432292,684	0,851	14,521	12299,903	49,144
19/04/2018 20:00	1,823	432177,957	0,873	14,469	12361,127	49,439
19/04/2018 21:00	1,786	430076,238	0,891	14,418	12408,03	49,624
19/04/2018 22:00	1,899	430493,309	0,901	14,131	12429,587	49,698
19/04/2018 23:00	1,905	428955,051	0,902	14,216	12424,983	49,7
20/04/2018 00:00	1,791	427619,909	0,915	14,173	12424,805	49,695
20/04/2018 01:00	5,806	395511,123	0,955	13,196	10406,402	39,473
20/04/2018 02:00	7,589	395771,169	0,97	12,967	10208,322	38,578
20/04/2018 03:00	3,252	433170,572	0,914	15,176	11719,746	46,533
20/04/2018 04:00	1,839	435810,421	0,913	14,35	12275,55	49,001
20/04/2018 05:00	1,935	435017,88	0,924	14,554	12260,807	48,985
20/04/2018 06:00	1,965	434437,196	0,909	14,466	12411,048	49,721
20/04/2018 07:00	5,601	432850,299	0,853	14,61	12484,915	49,989
20/04/2018 08:00	1,985	431746,755	0,892	14,331	12469,117	49,993
20/04/2018 09:00	1,932	431317,556	0,895	14,41	12446,623	49,888
20/04/2018 10:00	1,79	432259,821	0,866	14,292	12447,81	49,981
20/04/2018 11:00	1,822	432902,739	0,826	14,439	12349,286	49,487
20/04/2018 12:00	1,789	432548,543	0,813	14,387	12313,854	49,362
20/04/2018 13:00	1,747	432511,159	0,815	14,322	12223,322	48,973
20/04/2018 14:00	1,75	431895,048	0,819	14,37	12234,367	49,095
20/04/2018 15:00	1,723	428561,725	0,827	14,349	12198,534	49,013
20/04/2018 16:00	1,721	426630,625	0,815	14,359	12202,047	49,03
20/04/2018 17:00	1,75	426664	0,801	14,352	12214,849	48,979
20/04/2018 18:00	1,819	427605,882	0,803	14,247	12262,908	49,038
20/04/2018 19:00	1,835	427917,348	0,809	14,193	12291,995	49,055
20/04/2018 20:00	1,784	426729,1	0,821	14,083	12293,236	48,98
20/04/2018 21:00	1,766	427035,894	0,844	14,137	12275,734	49,015
20/04/2018 22:00	1,878	427162,466	0,844	14,144	12292,625	49,052
20/04/2018 23:00	1,87	425123,252	0,845	14,177	12295,297	49,021
21/04/2018 00:00	1,743	424705,384	0,861	14,384	12247,195	48,79
21/04/2018 01:00	1,78	424585,542	0,857	14,175	12305,286	49,055
21/04/2018 02:00	1,788	425968,731	0,865	14,232	12299,934	49,026
21/04/2018 03:00	1,929	426620,568	0,857	14,358	12299,35	49,052
21/04/2018 04:00	1,99	427623,09	0,845	14,279	12296,491	49,037
21/04/2018 05:00	1,954	422380,055	0,852	14,306	12299,148	49,025
21/04/2018 06:00	2,005	426758,739	0,839	14,421	12306,644	49,03
21/04/2018 07:00	5,386	426967,78	0,792	14,785	12314,871	49,056
21/04/2018 08:00	1,999	426753,161	0,835	14,884	12294,155	48,988

21/04/2018 09:00	1,944	426486,926	0,831	14,342	12271,264	48,966
21/04/2018 10:00	1,8	426819,144	0,828	14,021	12272,962	49,056
21/04/2018 11:00	1,785	426937,848	0,853	14,036	12252,447	49,006
21/04/2018 12:00	1,804	426901,032	0,851	14,187	12157,783	48,452
21/04/2018 13:00	1,819	427002,195	0,85	14,286	11825,963	46,963
21/04/2018 14:00		426516,391	0,836	15,803	12172,805	48,77
21/04/2018 15:00	1,759	426752,909	0,827	14,279	12180,536	48,891
21/04/2018 16:00	1,761	427101,656	0,832	14,213	12149,835	48,721
21/04/2018 17:00	1,834	427733,242	0,835	14,165	11793,968	46,876
21/04/2018 18:00	1,827	426453,304	0,832	14,265	12191,757	48,696
21/04/2018 19:00	1,883	426589,902	0,841	14,312	12242,87	48,813
21/04/2018 20:00	1,943	425914,008	0,847	14,223	12287,839	48,977
21/04/2018 21:00	1,891	426958,478	0,865	14,167	12311,703	49,051
21/04/2018 22:00	1,831	427127,874	0,865	13,985	12314,825	49,061
21/04/2018 23:00	1,908	427182,503	0,858	14,149	12316,277	49,057
22/04/2018 00:00	1,949	427040,118	0,869	14,196	12293,872	48,9
22/04/2018 01:00	2,3	427462,08	0,886	12,605	11691,308	45,999
22/04/2018 02:00	2,467	425461,665	0,88	13,314	11889,386	46,95
22/04/2018 03:00	1,854	423832,374	0,879	14,377	12313,818	48,998
22/04/2018 04:00	1,995	424252,203	0,884	14,425	12313,978	49,004
22/04/2018 05:00	1,887	421538,973	0,881	14,396	12309,409	49,003
22/04/2018 06:00	1,905	427006,075	0,883	14,375	12387,515	49,429
22/04/2018 07:00	7,214	427305,128	0,838	14,462	12021,579	47,517
22/04/2018 08:00	7,18	427561,873	0,885	14,219	11685,422	45,998
22/04/2018 09:00	3,158	428720,452	0,877	12,689	11680	45,998
22/04/2018 10:00	2,029	429788,399	0,878	12,011	11669,394	46,001
22/04/2018 11:00	1,964	429234,138	0,852	12,005	11670,254	46,002
22/04/2018 12:00	1,924	428299,648	0,85	12,27	11665,808	45,993
22/04/2018 13:00	1,827	427476,596	0,85	12,239	11656,124	45,998
22/04/2018 14:00	1,83	427784,861	0,844	12,423	11639,258	46,003
22/04/2018 15:00	1,794	427009,436	0,846	12,502	11626,697	46,003
22/04/2018 16:00	1,787	427064,434	0,833	12,441	11628,548	45,997
22/04/2018 17:00	1,767	427766,724	0,82	13,936	12100,074	48,388
22/04/2018 18:00	1,865	426673,695	0,82	14,348	12257,25	48,884
22/04/2018 19:00	1,838	425652,64	0,831	14,455	12349,806	49,26
22/04/2018 20:00	1,935	424222,401	0,84	14,544	12460,528	49,751
22/04/2018 21:00	1,944	425921,968	0,848	14,559	12511,998	49,953
22/04/2018 22:00	1,779	426350,077	0,871	14,526	12523,153	49,977
22/04/2018 23:00	1,862	423218,129	0,882	14,299	12528,05	50,004
23/04/2018 00:00	1,747	421865,506	0,891	14,244	12526,222	49,999
23/04/2018 01:00	1,731	421965,326	0,894	14,277	12522,58	49,996
23/04/2018 02:00	1,963	424156,292	0,878	14,361	12527,639	50,004
23/04/2018 03:00	1,916	425370,252	0,875	14,421	12527,187	49,999
23/04/2018 04:00	1,862	425415,508	0,868	14,414	12527,947	49,998
23/04/2018 05:00	1,846	422770,885	0,87	14,448	12513,287	49,999
23/04/2018 06:00	1,74	426184,477	0,86	14,324	12526,428	50,001
23/04/2018 07:00	5,496	426366,158	0,818	14,44	12526,832	49,998
23/04/2018 08:00	1,854	426064,241	0,852	14,348	12525,294	50,004
23/04/2018 09:00	1,926	423515,714	0,875	14,314	12507,511	49,997
23/04/2018 10:00	1,807	424082,066	0,851	14,315	12501,918	49,997
23/04/2018 11:00	1,821	424316,469	0,911	14,259	12504,716	50,001
23/04/2018 12:00	1,835	426911,542	0,835	14,449	12498,01	49,982
23/04/2018 13:00	1,81	426753,969	0,864	14,601	12432,514	49,678
23/04/2018 14:00	1,842	426878,358	0,859	14,619	12391,259	49,566
23/04/2018 15:00	1,845	425563,855	0,859	14,554	12339,88	49,253
23/04/2018 16:00	1,822	425918,804	0,866	14,446	12335,694	49,212
23/04/2018 17:00	1,875	425661,939	0,844	14,564	12445,088	49,723
23/04/2018 18:00	1,936	424712,964	0,856	14,578	12485,685	49,89
23/04/2018 19:00	1,864	425769,467	0,863	14,683	12503,947	49,908
23/04/2018 20:00	1,919	424588,003	0,872	14,6	12517,033	49,967
23/04/2018 21:00	1,901	426823,347	0,875	14,419	12524,345	49,998
23/04/2018 22:00	1,954	427095,8	0,873	14,336	12524,067	49,999
23/04/2018 23:00	1,936	427361,688	0,876	14,365	12521,842	49,998
24/04/2018 00:00	1,978	427316,676	0,876	14,351	12520,905	49,999
24/04/2018 01:00	1,903	427483,766	0,877	14,435	12523,764	49,998
24/04/2018 02:00	1,936	427390,779	0,88	14,374	12521,662	50
24/04/2018 03:00	1,997	426971,613	0,872	14,477	12520,969	49,999
24/04/2018 04:00	1,924	427237,964	0,883	14,394	12516,812	49,999
24/04/2018 05:00	1,935	427470,977	0,882	14,509	12499,274	49,998
24/04/2018 06:00	1,833	427602,639	0,87	14,535	12522,679	49,998
24/04/2018 07:00	5,425	428122,519	0,862	14,483	12530,213	49,999
24/04/2018 08:00	2,093	428120,112	0,883	14,555	12530,76	50,002
24/04/2018 09:00	2,12	429112,273	0,877	14,411	12521,357	50
24/04/2018 10:00	2,085	430309,346	0,883	14,468	12492,892	49,974
24/04/2018 11:00	1,993	431096,608	0,88	14,52	12401,491	49,545
24/04/2018 12:00	1,882	427777,428	0,836	14,483	12325,275	49,237
24/04/2018 13:00	1,862	427532,314	0,825	14,461	12323,115	49,295
24/04/2018 14:00	1,793	426673,01	0,836	14,441	12313,881	49,316
24/04/2018 15:00	1,822	428912,55	0,824	14,44	12247,607	49,112
24/04/2018 16:00	1,747	428468,197	0,809	14,593	12323,422	49,541
24/04/2018 17:00	1,783	426857,255	0,81	14,735	12406,781	49,803
24/04/2018 18:00	1,814	427667,717	0,81	14,728	12436,549	49,752
24/04/2018 19:00	1,922	426743,035	0,81	14,615	12491,486	49,942
24/04/2018 20:00	1,853	425357,784	0,828	14,345	12509,939	49,999
24/04/2018 21:00	1,786	426377,831	0,85	14,428	12491,335	49,893
24/04/2018 22:00	1,809	427393,853	0,85	14,319	12518,458	49,997
24/04/2018 23:00	1,93	425489,349	0,866	14,48	12512,645	49,994
25/04/2018 00:00	1,791	426024,627	0,859	14,727	12467,72	49,761
25/04/2018 01:00	1,856	426398,48	0,87	14,478	12510,849	49,966
25/04/2018 02:00	1,787	425903,62	0,88	14,519	12511,427	49,997
25/04/2018 03:00	1,802	425749,818	0,878	14,549	12509,188	50,002
25/04/2018 04:00	1,821	425609,474	0,85	14,601	12503,543	49,986
25/04/2018 05:00	1,973	424317,895	0,851	14,718	12499,937	50
25/04/2018 06:00	1,879	427317,861	0,856	14,78	12512,666	49,987
25/04/2018 07:00	64,123	363852,504	0,893	12,808	9235,228	33,291
25/04/2018 08:00	61,66	357229,68	0,945	12,334	8941,155	31,998
25/04/2018 09:00	50,59	351867,602	0,956	11,74	8927,957	32,001
25/04/2018 10:00	48,625	350197,977	0,944	11,344	8899,53	32
25/04/2018 11:00	96,631	352040,988	2,643	10,303	8879,917	32,001
25/04/2018 12:00	77,289	349734,374	0,984	10,54	8868,886	31,999
25/04/2018 13:00	85,177	350468,059	0,958	10,276	8857,844	32
25/04/2018 14:00	85,923	352010,242	0,981	10,303	8839,974	31,996

25/04/2018 15:00	87,118	353398,95	0,968	10,333	8826,278	32,003
25/04/2018 16:00	77,685	358361,555	0,988	10,644	8957,398	32,719
25/04/2018 17:00	4,055	427914,711	0,894	13,22	11249,261	44,235
25/04/2018 18:00	2,746	434325,509	0,874	12,638	11440,18	44,998
25/04/2018 19:00	2,942	436131,056	0,873	12,554	11459,737	44,996
25/04/2018 20:00	3,682	433688,959	0,896	13,081	11467,506	45,003
25/04/2018 21:00	5,087	430939,235	0,898	14,098	11464,616	44,995
25/04/2018 22:00	6,512	431524,45	0,904	14,617	11466,902	45,002
25/04/2018 23:00	4,579	429108,599	0,883	14,408	12058,023	47,843
26/04/2018 00:00	1,849	427158,691	0,852	14,279	12500,499	50
26/04/2018 01:00	1,875	426212,92	0,855	14,298	12505,039	50,002
26/04/2018 02:00	1,939	426359,084	0,874	14,304	12504,101	49,999
26/04/2018 03:00	1,92	425836,706	0,876	14,434	12506,027	50,001
26/04/2018 04:00	1,943	424929,59	0,872	14,54	12511,407	49,997
26/04/2018 05:00	1,943	414426,935	0,874	14,621	12508,564	50,001
26/04/2018 06:00	1,9	426852,487	0,864	14,602	12524,321	50
26/04/2018 07:00	5,581	427710,534	0,819	15,047	12520,488	50,001
26/04/2018 08:00	2,298	427770,851	0,884	15,439	11793,785	46,16
26/04/2018 09:00	1,981	422452,314	0,865	15,204	11830,201	46,734
26/04/2018 10:00	1,843	429441,756	0,859	14,368	12481,16	50,003
26/04/2018 11:00	1,869	430465,672	0,892	14,32	12472,887	49,972
26/04/2018 12:00	5,062	429635,645	0,749	14,46	12469,568	49,997
26/04/2018 13:00	1,827	429512,871	0,782	14,437	12463,102	49,976
26/04/2018 14:00	1,776	428927,734	0,787	14,494	12442,081	49,981
26/04/2018 15:00	1,765	429203,52	0,788	14,579	12426,758	49,999
26/04/2018 16:00	1,773	428730,168	0,787	14,624	12424,298	49,999
26/04/2018 17:00	1,769	428197,876	0,787	14,835	12428,822	50,003
26/04/2018 18:00	1,838	425215,16	0,789	14,847	12472,739	49,995
26/04/2018 19:00	1,948	426161,309	0,801	14,732	12496,951	49,999
26/04/2018 20:00	1,837	424323,38	0,817	14,854	12500,12	50
26/04/2018 21:00	1,951	428006,543	0,827	15,059	12502,271	49,999
26/04/2018 22:00	1,844	429351,738	0,832	15,129	12503,122	49,999
26/04/2018 23:00	1,839	429592,995	0,841	15,123	12493,871	49,998
27/04/2018 00:00	1,79	427584,778	0,845	15,183	12489,145	49,997
27/04/2018 01:00	1,871	427814,974	0,834	15,284	12495,021	50,003
27/04/2018 02:00	2,74	427319,911	0,867	19,92	11587,644	45,403
27/04/2018 03:00	2,57	426710,416	0,867	19,562	11660,411	46,076
27/04/2018 04:00	1,996	427047,113	0,84	15,57	12459,027	50
27/04/2018 05:00	1,962	418672,581	0,851	15,561	12444,864	50,001
27/04/2018 06:00	1,895	427810,346	0,837	15,592	12452,23	50
27/04/2018 07:00	5,932	427640,792	0,792	15,468	12439,107	50,001
27/04/2018 08:00	2,101	427398,362	0,819	15,195	12427,777	50,001
27/04/2018 09:00	2,046	428154,82	0,789	14,842	12423,632	50
27/04/2018 10:00	1,893	428029,069	0,78	14,798	12412,857	50
27/04/2018 11:00	1,832	427822,795	0,796	14,777	12395,769	50,005
27/04/2018 12:00	1,872	427496,932	0,813	14,783	12325,173	49,738
27/04/2018 13:00	1,801	428296,192	0,817	14,753	12373,945	49,996
27/04/2018 14:00	1,812	429363,389	0,814	14,795	12391,033	49,984
27/04/2018 15:00	1,803	425922,52	0,826	14,925	12377,976	49,903
27/04/2018 16:00	1,811	426335,185	0,819	15,055	12339,576	49,828
27/04/2018 17:00	1,824	426953,433	0,813	15,04	12376,932	49,914
27/04/2018 18:00	1,954	428132,572	0,808	14,92	12432,264	49,994
27/04/2018 19:00	2,076	428908,303	0,826	14,712	12451,214	50,002
27/04/2018 20:00	2,006	426189,824	0,848	14,669	12459,558	49,995
27/04/2018 21:00	1,82	428334,398	0,855	14,604	12461,109	50,003
27/04/2018 22:00	1,993	427124,543	0,84	14,668	12453,688	49,999
27/04/2018 23:00	2,009	427442,645	0,858	14,695	12451,765	50
28/04/2018 00:00	1,92	426145,935	0,858	14,722	12376,493	49,68
28/04/2018 01:00	1,914	426447,971	0,851	14,716	12469,659	49,969
28/04/2018 02:00	1,993	426959,751	0,844	14,674	12469,842	49,957
28/04/2018 03:00	2,059	425692,095	0,838	14,627	12475,231	49,997
28/04/2018 04:00	2,028	426833,452	0,84	14,568	12472,483	49,984
28/04/2018 05:00	2,035	423119,915	0,843	14,643	12465,603	49,983
28/04/2018 06:00	2,02	427365,857	0,838	14,667	12468,424	49,998
28/04/2018 07:00	5,848	427187,269	0,802	14,69	12459,606	49,988
28/04/2018 08:00	2,011	426615,957	0,824	14,623	12446,859	49,979
28/04/2018 09:00	2,026	428034,075	0,825	14,679	12447,824	50
28/04/2018 10:00	2,152	427415,216	0,824	14,668	12436,97	49,989
28/04/2018 11:00	2,084	427262,045	0,859	14,613	12428,413	49,998
28/04/2018 12:00	1,914	428299,697	0,798	14,7	12314,767	49,446
28/04/2018 13:00	1,868	427016,025	0,8	14,721	12382,01	49,886
28/04/2018 14:00	1,825	427088,512	0,783	14,601	12405,762	49,996
28/04/2018 15:00	1,812	425062,87	0,801	14,719	12414,836	49,984
28/04/2018 16:00	1,924	425576,985	0,79	14,993	12339,538	49,551
28/04/2018 17:00	1,923	426333,884	0,781	14,991	12381,68	49,639
28/04/2018 18:00	1,985	426724,944	0,784	15,041	12417,642	49,759
28/04/2018 19:00	2,07	427487,244	0,795	15,095	12439,628	49,801
28/04/2018 20:00	2,086	426957,299	0,776	14,912	12479,954	49,984
28/04/2018 21:00	2,031	424689,12	0,794	14,823	12474,562	49,945
28/04/2018 22:00	2,021	425891,948	0,808	14,717	12479,79	49,979
28/04/2018 23:00	2,14	425787,233	0,824	14,561	12479,63	50,002
29/04/2018 00:00	2,176	425392,74	0,805	14,633	12488,556	49,997
29/04/2018 01:00	2,071	426439,88	0,793	14,796	12491,097	49,999
29/04/2018 02:00	1,939	425321,136	0,781	14,98	12497,867	49,997
29/04/2018 03:00	1,932	425480,002	0,799	14,897	12499,471	49,997
29/04/2018 04:00	1,954	426173,435	0,801	14,918	12498,813	49,997
29/04/2018 05:00	1,919	418113,421	0,805	14,867	12503,378	49,996
29/04/2018 06:00	6,381	426584,793	0,811	16,073	11721,354	46,255
29/04/2018 07:00	7,345	426958,601	0,773	15,818	12082,549	47,957
29/04/2018 08:00	2,223	427330,44	0,81	14,88	12490,71	50,003
29/04/2018 09:00	2,172	424959,775	0,793	14,781	12481,577	50
29/04/2018 10:00	2,028	425945,339	0,787	14,536	12463,348	49,998
29/04/2018 11:00	1,965	426265,366	0,792	14,612	12432,256	49,918
29/04/2018 12:00	1,889	426674,479	0,802	14,735	12384,17	49,658
29/04/2018 13:00	1,897	427794,778	0,792	14,731	12343,228	49,443
29/04/2018 14:00	1,9	425660,989	0,79	14,683	12324,008	49,395
29/04/2018 15:00	1,891	425515,896	0,802	14,669	12318	49,419
29/04/2018 16:00	1,849	425405,829	0,807	14,747	12339,083	49,494
29/04/2018 17:00	1,847	425071,895	0,796	14,826	12399,874	49,719
29/04/2018 18:00	1,885	416836,719	0,84	14,99	12465,156	49,934
29/04/2018 19:00	1,905	417723,497	0,846	14,783	12492,132	49,99
29/04/2018 20:00	2	419590,447	0,833	14,777	12492,78	50,001

29/04/2018 21:00	2,069	426243,408	0,82	14,834	12499,4	50,004
29/04/2018 22:00	2,016	426895,09	0,822	14,818	12497,796	50,003
29/04/2018 23:00	2,098	426402,159	0,822	14,875	12495,784	50,001
30/04/2018 00:00	2,061	425252,696	0,839	14,868	12492,643	49,998
30/04/2018 01:00	2,046	427354,236	0,834	14,761	12491,295	50
30/04/2018 02:00	60,24	384522,293	0,881	13,491	10751,282	41,104
30/04/2018 03:00	2,011	425450,671	0,848	14,595	12484,107	49,945
30/04/2018 04:00	2,017	425098,431	0,846	14,832	12492,909	50,001
30/04/2018 05:00	2,088	421571,486	0,816	14,97	12490,886	49,998
30/04/2018 06:00	1,986	427739,063	0,817	14,99	12496,491	49,999
30/04/2018 07:00	5,153	428464,583	0,776	15,281	12495,984	49,996
30/04/2018 08:00	2,134	427589,888	0,785	15,126	12488,308	49,998
30/04/2018 09:00	2,105	426366,914	0,819	15,179	12485,342	50,002
30/04/2018 10:00	2,168	427795,54	0,83	14,944	12481,651	49,998
30/04/2018 11:00	2,107	427512,078	0,815	14,637	12471,668	50,007
30/04/2018 12:00	1,969	429189,441	0,809	14,583	12471,037	49,997
30/04/2018 13:00	1,919	429044,339	0,805	14,666	12473,618	49,99
30/04/2018 14:00	2,739	426829,192	0,806	14,743	12224,79	48,642
30/04/2018 15:00	14,882	401820,471	0,869	15,299	10453,484	40,003
30/04/2018 16:00	15,198	402212,128	0,867	15,318	10443,36	39,998
30/04/2018 17:00	18,735	401929,809	0,869	15,148	10445,285	39,999
30/04/2018 18:00	20,446	404573,137	0,861	15,382	10467,679	39,997
30/04/2018 19:00	22,604	405153,055	0,886	15,448	10483,533	39,998
30/04/2018 20:00	25,444	405849,953	0,904	15,44	10485,605	39,998
30/04/2018 21:00	29,507	406017,49	0,913	15,384	10489,866	40,004
30/04/2018 22:00	34,02	406910,488	0,902	15,296	10487,385	39,996
30/04/2018 23:00	28,752	407448,647	0,888	16,312	10509,826	40,182
01/05/2018 00:00	4,78	425637,212	0,88	18,178	11404,629	44,87
01/05/2018 01:00	2,352	425420,123	0,875	15,413	11942,224	47,275
01/05/2018 02:00	2,387	419578,131	0,895	20,492	11503,91	44,999
01/05/2018 03:00	2,677	417582,722	0,894	21,267	11501,077	45,001
01/05/2018 04:00	2,749	418224,176	0,912	20,911	11500,322	45,037
01/05/2018 05:00	2,579	415221,557	0,877	16,321	12365,549	49,334
01/05/2018 06:00	2,014	424723,4	0,832	15,789	12503,061	49,998
01/05/2018 07:00	6,004	424571,067	0,791	15,555	12500,89	50,002
01/05/2018 08:00	2,118	424845,648	0,848	15,254	12499,222	50
01/05/2018 09:00	2,052	424864,595	0,839	14,726	12484,799	50
01/05/2018 10:00	2,004	425290,639	0,816	14,661	12460,029	49,999
01/05/2018 11:00	1,919	425781,688	0,831	14,569	12438,348	49,969
01/05/2018 12:00	1,942	426743,268	0,806	14,716	12298,42	49,244
01/05/2018 13:00	1,944	427382,012	0,803	14,92	12210,581	48,853
01/05/2018 14:00	1,905	425715,451	0,797	14,819	12431,781	49,994
01/05/2018 15:00	1,977	425640,796	0,807	15,004	12077,185	48,191
01/05/2018 16:00	1,913	425733,317	0,787	14,999	12435,598	49,959
01/05/2018 17:00	1,873	425016,409	0,776	15,024	12449,509	49,976
01/05/2018 18:00	1,885	426398,843	0,785	14,659	12459,397	49,972
01/05/2018 19:00	1,94	425996,155	0,792	14,642	12481,243	49,997
01/05/2018 20:00	1,891	425780,135	0,805	14,727	12488,599	49,998
01/05/2018 21:00	1,877	423879,975	0,832	14,762	12494,509	50,003
01/05/2018 22:00	1,866	424487,844	0,839	14,702	12492,788	49,999
01/05/2018 23:00	1,975	424057,133	0,834	14,86	12491,659	50
02/05/2018 00:00	2,012	424784,863	0,813	14,918	12500,608	49,997
02/05/2018 01:00	2,003	424983,012	0,829	14,943	12498,62	49,998
02/05/2018 02:00	2,099	423012,401	0,822	15,15	12498,56	50,005
02/05/2018 03:00	2,138	422646,692	0,824	15,071	12503,711	49,999
02/05/2018 04:00	4,871	420492,56	0,83	16,598	11952,232	46,918
02/05/2018 05:00	62,43	335489,8	0,877	10,574	9354,58	34,116
02/05/2018 06:00	79,488	366717,711	0,909	10,557	9248,915	33,495
02/05/2018 07:00	553,543	306212,421	0,925	12,589	7330,944	22,26
02/05/2018 08:00	568,327	304092,361	0,97	12,243	7264,435	22,002
02/05/2018 09:00	551,323	303528,102	0,966	12,154	7236,273	21,997
02/05/2018 10:00	530,221	302632,02	0,963	12,117	7216,537	21,998
02/05/2018 11:00	508,202	295384,037	0,955	12,376	7172,96	21,998
02/05/2018 12:00	479,312	293816,037	0,945	12,348	7136,338	22
02/05/2018 13:00	459,072	293425,761	0,975	12,356	7113,775	22,001
02/05/2018 14:00	444,207	291976,068	0,985	12,317	7086,815	21,994
02/05/2018 15:00	436,513	292925,171	0,925	12,293	7082,568	22,003
02/05/2018 16:00	438,192	293389,887	0,961	12,267	7089,658	22,002
02/05/2018 17:00	440,717	295210,188	0,969	12,212	7096,069	22,001
02/05/2018 18:00	464,538	296382,847	0,971	12,039	7130,189	21,999
02/05/2018 19:00	480,224	296624,098	0,972	12,108	7156,232	22,001
02/05/2018 20:00	493,752	297393,693	0,993	12,171	7174,826	22
02/05/2018 21:00	499,418	298237,087	1,002	12,124	7185,965	21,999
02/05/2018 22:00	506,852	298621,004	0,998	12,134	7193,047	21,995
02/05/2018 23:00	512,963	298620,529	1,003	12,066	7199,069	22,001
03/05/2018 00:00	522,315	299144,368	0,998	12,15	7209,667	22,001
03/05/2018 01:00	522,425	299107,868	1,007	12,177	7210,627	22
03/05/2018 02:00	517,796	297417,773	1,018	12,402	7204,836	22
03/05/2018 03:00	529,435	297850,082	1,004	12,155	7217,631	22
03/05/2018 04:00	528,491	297970,057	0,995	12,121	7215,335	21,997
03/05/2018 05:00	521,087	295972,566	1,009	12,262	7192,019	22,002
03/05/2018 06:00	535,064	300628,131	0,984	12,118	7224,84	21,997
03/05/2018 07:00	549,819	300802,825	0,929	12,182	7244,682	22,001
03/05/2018 08:00	527,747	299883,629	0,99	12,41	7215,892	22
03/05/2018 09:00	509,754	297314,612	0,988	12,34	7187,458	22
03/05/2018 10:00	488,738	294910,025	1,007	12,21	7157,313	21,998
03/05/2018 11:00	471,727	291415,787	0,982	12,139	7134,602	22
03/05/2018 12:00	434,937	289805,152	0,975	12,468	7094,015	21,999
03/05/2018 13:00	420,726	289930,636	0,962	12,555	7076,693	21,997
03/05/2018 14:00	399,117	289606,257	0,975	12,803	7051,447	22
03/05/2018 15:00	388,25	290594,827	0,983	13,099	7033,306	21,999
03/05/2018 16:00	393,379	291327,371	0,977	13,09	7032,604	21,998
03/05/2018 17:00	408,036	292024,215	0,97	12,809	7051,166	21,999
03/05/2018 18:00	441,081	293841,219	0,969	12,313	7094,213	22
03/05/2018 19:00	456,507	293949,336	0,973	12,441	7117,531	22,001
03/05/2018 20:00	465,542	295073,066	0,986	12,625	7132,119	22,002
03/05/2018 21:00	468,028	295584,432	0,984	12,603	7136,218	21,999
03/05/2018 22:00	484,781	296298,28	0,997	12,455	7146,736	21,997
03/05/2018 23:00	487,567	296312,39	1,009	12,587	7149,616	22
04/05/2018 00:00	447,012	302311,221	1,008	12,75	7324,831	23,03
04/05/2018 01:00	497,497	297498,844	1,003	12,51	7177,216	22,004
04/05/2018 02:00	496,122	295151,942	1,027	12,686	7170,537	22,002

04/05/2018 03:00	526,62	296263,264	1,002	12,565	7203,149	22
04/05/2018 04:00	507,477	295393,816	0,994	12,707	7177,518	22
04/05/2018 05:00	514,957	295506,862	0,993	12,561	7172,958	22
04/05/2018 06:00	516,14	298959,998	0,998	12,648	7192,254	21,998
04/05/2018 07:00	522,466	299491,81	0,955	12,784	7203,299	21,998
04/05/2018 08:00	478,937	300813,182	0,992	13,075	7325,195	23,258
04/05/2018 09:00	66,352	372685,222	0,905	14,528	9791,539	35,562
04/05/2018 10:00	73,03	347976,794	0,923	14,309	8870,739	32,017
04/05/2018 11:00	61,984	330905,577	0,945	13,645	8488,121	30
04/05/2018 12:00	44,231	330442,376	2,329	13,45	8482,098	30,003
04/05/2018 13:00	33,314	330368,887	0,922	13,372	8480,301	29,998
04/05/2018 14:00	29,032	330140,494	0,916	13,429	8480,599	30,003
04/05/2018 15:00	336,292	291542,969	0,971	13,534	7121,637	22,508
04/05/2018 16:00	168,477	329801,048	0,946	14,074	8268,431	29,123
04/05/2018 17:00	1,944	429826,187	0,822	14,441	11988,831	48
04/05/2018 18:00	2,269	431103,232	0,822	14,505	12028,069	47,973
04/05/2018 19:00	2,06	429302,145	0,828	14,594	12042,226	47,998
04/05/2018 20:00	2,134	427362,254	0,862	15,591	11668,303	46,043
04/05/2018 21:00	2,112	425556,025	0,875	16,077	11294,707	44,251
04/05/2018 22:00	10,884	419080,357	0,891	14,091	11165,4	43,538
04/05/2018 23:00	21,719	402214,988	0,902	15,407	10494,182	40,2
05/05/2018 00:00	2,342	427350,902	0,876	17,012	11527,49	45,399
05/05/2018 01:00	2,009	428456,463	0,858	14,251	12064,546	48
05/05/2018 02:00	2,027	427135,047	0,858	14,005	12058,656	48,002
05/05/2018 03:00	1,913	426522,784	0,852	13,887	12062,888	48,001
05/05/2018 04:00	2,06	425604,297	0,853	13,881	12064,088	48,001
05/05/2018 05:00	1,99	424163,573	0,844	13,942	12056,752	47,999
05/05/2018 06:00	2	426968,307	0,837	13,918	12056,642	47,992
05/05/2018 07:00	6,118	426878,345	0,783	14,571	12059,296	48
05/05/2018 08:00	2,265	426786,793	0,813	14,482	12285,173	49,078
05/05/2018 09:00	1,949	426835,699	0,822	14,907	12462,209	49,997
05/05/2018 10:00	1,919	426896,363	0,79	14,815	12453,35	50,003
05/05/2018 11:00	1,905	425320,377	0,794	15,086	12421,524	49,836
05/05/2018 12:00	1,883	425754,76	0,858	14,928	12312,388	49,315
05/05/2018 13:00	1,88	426078,568	0,811	14,743	12258,39	49,069
05/05/2018 14:00	1,904	425268,504	0,814	14,666	12131,755	48,634
05/05/2018 15:00	1,906	426574,852	0,823	14,551	12148,828	48,709
05/05/2018 16:00	1,877	427867,774	0,804	14,61	12168,761	48,807
05/05/2018 17:00	1,854	426429,629	0,796	14,761	12221,232	48,984
05/05/2018 18:00	1,867	426651,357	0,793	14,95	12326,856	49,357
05/05/2018 19:00	1,876	426811,362	0,788	15,113	12427,425	49,756
05/05/2018 20:00	1,994	426457,972	0,804	15,294	12429,111	49,694
05/05/2018 21:00	2,006	428628,203	0,804	14,979	12485,253	49,988
05/05/2018 22:00	2,054	428519,029	0,814	14,879	12497,646	49,998
05/05/2018 23:00	2,002	427343,172	0,826	14,989	12499,504	50,003
06/05/2018 00:00	1,89	426569,35	0,817	15,138	12495,281	49,999
06/05/2018 01:00	1,95	426577,319	0,823	15,202	12492,536	50,002
06/05/2018 02:00	1,974	425174,907	0,836	15,232	12442,9	49,821
06/05/2018 03:00	1,918	425547,252	0,843	15,013	12500,473	49,998
06/05/2018 04:00	1,992	425424,51	0,828	15,012	12497,218	49,996
06/05/2018 05:00	1,874	423617,588	0,796	34,734	12495,727	49,997
06/05/2018 06:00	1,602	427410,621	0,811	35,31	12496,705	50,001
06/05/2018 07:00	1,547	427350,408	0,824	35,433	12494,787	50,001
06/05/2018 08:00	1,566	427233,303	0,868	35,409	12489,611	49,998
06/05/2018 09:00	1,577	424164,482	1,06	35,23	12206,57	48,595
06/05/2018 10:00	1,495	399876,541	1,681	35,072	10458,148	40,005
06/05/2018 11:00	1,449	396467,351	3,055	34,689	10457,04	39,998
06/05/2018 12:00	1,375	396618,27	5,125	34,513	10447,117	40
06/05/2018 13:00	1,326	397877,418	7,797	34,472	10443,604	39,999
06/05/2018 14:00	1,285	408059,106	9,048	34,141	10929,192	42,72
06/05/2018 15:00	1,24	434286,315	9,779	34,092	12361,693	49,691
06/05/2018 16:00	1,213	432286,793	10,188	34,094	12346,766	49,601
06/05/2018 17:00	1,2	429720,839	10,331	34,123	12396,729	49,794
06/05/2018 18:00	1,21	429342,143	10,659	34,129	12446,784	49,905
06/05/2018 19:00	1,245	428164,729	10,716	34,24	12482,556	49,994
06/05/2018 20:00	1,25	428105,266	11,12	34,379	12483,967	49,988
06/05/2018 21:00	1,258	427175,034	11,165	34,515	12489,987	49,986
06/05/2018 22:00	1,344	427482,705	10,932	34,363	12494,076	50
06/05/2018 23:00	1,309	427298,748	11,039	34,43	12493,352	49,997
07/05/2018 00:00	1,264	427441,806	10,906	34,428	12496,965	49,997
07/05/2018 01:00	1,246	427399,621	10,879	34,41	12498,801	49,999
07/05/2018 02:00	1,217	425760,128	11,096	34,515	12496,047	50,001
07/05/2018 03:00	1,202	428557,782	11,313	34,521	12492,596	49,999
07/05/2018 04:00	1,219	428101,301	10,926	34,504	12488,317	49,995
07/05/2018 05:00	1,263	425641,268	10,852	34,49	12480,622	49,998
07/05/2018 06:00	1,298	428323,738	10,8	34,416	12498,401	49,998
07/05/2018 07:00	1,308	428005,839	10,94	34,485	12501,748	49,995
07/05/2018 08:00	1,396	426790,29	10,595	34,546	12502,569	50,002
07/05/2018 09:00	1,363	427813,293	10,934	34,506	12498,076	50,002
07/05/2018 10:00	1,379	427558,868	10,599	34,234	12475,004	49,995
07/05/2018 11:00	1,361	427643,087	10,458	34,018	12464,284	49,98
07/05/2018 12:00	1,338	429150,785	10,792	33,832	12414,64	49,738
07/05/2018 13:00	1,391	429689,924	10,59	33,216	12368,695	49,54
07/05/2018 14:00		429602,404	1,484	15,83	12359,857	49,567
07/05/2018 15:00	1,824	429427,883	0,799	15,413	12356,928	49,621
07/05/2018 16:00	1,823	429624,178	0,794	15,493	12368,183	49,638
07/05/2018 17:00	1,824	429510,587	0,793	15,606	12414,701	49,755
07/05/2018 18:00	1,848	428223,963	0,798	15,783	12461,372	49,927
07/05/2018 19:00	1,878	428366,306	0,795	15,697	12481,76	49,954
07/05/2018 20:00	1,902	428007,058	0,801	16,075	12451,67	49,824
07/05/2018 21:00	1,886	425422,357	0,829	15,87	12483,585	49,962
07/05/2018 22:00	1,874	426009,241	0,829	15,857	12488,752	49,991
07/05/2018 23:00	1,955	425348,629	0,837	15,567	12483,168	50,001
08/05/2018 00:00	1,984	425777,69	0,844	15,632	12484,685	50
08/05/2018 01:00	1,996	425382,644	0,836	15,703	12485,534	50,008
08/05/2018 02:00	2,027	424544,673	0,83	15,705	12482,428	50,003
08/05/2018 03:00	1,995	426756,619	0,846	15,807	12480,422	49,998
08/05/2018 04:00	1,985	426749,362	0,834	15,798	12477,305	49,998
08/05/2018 05:00	1,941	421923,055	0,838	15,805	12463,084	50,001
08/05/2018 06:00	2,108	426066,035	0,823	15,87	12485,069	50
08/05/2018 07:00	4,939	426402,347	0,796	15,855	12489,304	49,999
08/05/2018 08:00	1,982	425124,96	0,848	15,817	12484,911	49,997

08/05/2018 09:00	2,007	426671,75	0,83	15,754	12481,608	49,996
08/05/2018 10:00	1,956	427120,629	0,82	15,611	12461,224	49,968
08/05/2018 11:00	1,923	426596,568	0,807	15,886	12430,281	49,824
08/05/2018 12:00	1,934	429038,202	0,824	15,728	12334,443	49,341
08/05/2018 13:00	1,906	428470,981	0,79	15,483	12270,245	49,069
08/05/2018 14:00	1,874	427838,373	0,784	15,484	12274,797	49,053
08/05/2018 15:00	1,85	428332,22	0,774	15,487	12269,705	49,141
08/05/2018 16:00	1,873	428275,566	0,769	15,556	12288,075	49,286
08/05/2018 17:00	1,876	427988,782	0,774	15,701	12338,209	49,422
08/05/2018 18:00	1,893	426958,454	0,772	15,986	12412,87	49,677
08/05/2018 19:00	1,933	426886,592	0,773	16,002	12460,438	49,837
08/05/2018 20:00	2,01	428047,469	0,782	16,104	12455,787	49,795
08/05/2018 21:00	2,002	428171,697	0,792	15,739	12512,14	50
08/05/2018 22:00	1,915	428465,346	0,798	15,714	12520,477	50,001
08/05/2018 23:00	1,909	427485,807	0,816	15,685	12521,334	49,998
09/05/2018 00:00	1,926	427353,003	0,812	15,695	12523,499	50,004
09/05/2018 01:00	2,011	427327,961	0,812	15,713	12520,126	49,999
09/05/2018 02:00	1,924	425036,787	0,808	15,817	12519,777	49,996
09/05/2018 03:00	1,993	426411,607	0,818	15,824	12524,532	50,004
09/05/2018 04:00	1,981	426234,532	0,799	15,8	12526,12	49,994
09/05/2018 05:00	1,98	423666,675	0,794	15,787	12511,871	50
09/05/2018 06:00	1,966	427089,714	0,8	15,744	12536,895	49,997
09/05/2018 07:00	5,791	427261,921	0,769	15,706	12551,602	49,998
09/05/2018 08:00	2,196	426108,362	0,794	15,782	12536,171	50,001
09/05/2018 09:00	2,105	425151,06	0,802	15,737	12530,913	50,004
09/05/2018 10:00	2,093	424834,807	0,8	15,638	12517,492	49,991
09/05/2018 11:00	1,995	424750,181	0,795	15,442	12516,539	50,003
09/05/2018 12:00	1,962	428592,854	0,786	15,425	12514,992	49,996
09/05/2018 13:00	1,881	428790,409	0,759	15,345	12502,57	49,997
09/05/2018 14:00	1,899	428156,621	0,754	15,535	12492,973	49,993
09/05/2018 15:00	1,936	428398,398	0,747	15,494	12495,957	49,992
09/05/2018 16:00	1,875	427762,966	0,744	15,555	12488,424	49,999
09/05/2018 17:00	1,844	427430,292	0,74	15,676	12501,167	49,999
09/05/2018 18:00	1,848	427068,409	0,746	15,733	12525,882	49,998
09/05/2018 19:00	1,889	427307,833	0,75	15,724	12549,964	49,997
09/05/2018 20:00	1,917	427349,732	0,743	15,766	12559,025	50
09/05/2018 21:00	1,941	427797,034	0,755	15,935	12550,997	49,997
09/05/2018 22:00	2,03	428419,93	0,779	16,087	12538,112	50,002
09/05/2018 23:00	1,989	427959,215	0,77	16,169	12534,513	50
10/05/2018 00:00	2,163	428292,016	0,775	16,218	12537,83	50,001
10/05/2018 01:00	2,08	429547,655	0,783	16,389	12548,729	50,001
10/05/2018 02:00	2,181	426474,91	0,78	16,674	12548,796	49,999
10/05/2018 03:00	2,002	428062,633	0,781	16,734	12547,862	50,001
10/05/2018 04:00	1,938	427911,091	0,786	16,735	12551,081	49,999
10/05/2018 05:00	2,004	424440,183	0,788	16,621	12537,403	50
10/05/2018 06:00	1,98	428371,072	0,792	16,701	12557,331	50,002
10/05/2018 07:00	42,819	386804,737	0,778	13,546	10159,452	37,796
10/05/2018 08:00	50,835	371648,243	0,84	11,44	9566,544	35,002
10/05/2018 09:00	39,808	371934,349	0,851	11,498	9558,932	34,995
10/05/2018 10:00	46,307	371947,121	0,859	10,582	9537,308	35,003
10/05/2018 11:00	40,394	367962,076	0,828	10,573	9527,359	34,999
10/05/2018 12:00	34,72	367865,281	0,826	10,469	9516,272	34,997
10/05/2018 13:00	25,45	372685,766	0,868	11,043	9643,577	35,815
10/05/2018 14:00	21,923	400991,968	0,848	16,478	10495,329	40,001
10/05/2018 15:00	6,984	424953,6	0,818	15,801	11976,963	47,568
10/05/2018 16:00	1,841	432440,902	0,809	15,521	12483,234	49,997
10/05/2018 17:00	1,854	432102,23	0,8	15,429	12504,093	50
10/05/2018 18:00	1,972	432764,294	0,806	15,553	12531,691	49,997
10/05/2018 19:00	18,217	411435,045	0,835	16,45	11100,183	42,686
10/05/2018 20:00	44,569	384998,629	0,889	13,918	9950,095	37,09
10/05/2018 21:00	63,912	365275,179	0,913	11,06	9345,667	34
10/05/2018 22:00	65,848	365151,436	0,924	11,192	9350,268	34,001
10/05/2018 23:00	211,374	332848,917	0,958	12,321	8690,234	29,945
11/05/2018 00:00	544,886	297009,864	1,01	13,411	7288,742	21,998
11/05/2018 01:00	550,67	297837,857	0,995	13,368	7295,098	22,005
11/05/2018 02:00	548,49	297134	0,987	13,246	7295,158	21,998
11/05/2018 03:00	544,266	298444,543	0,994	13,248	7289,043	22,001
11/05/2018 04:00	551,745	299088,561	0,994	13,139	7284,594	22
11/05/2018 05:00	70,355	390138,334	0,9	17,894	10271,481	38,746
11/05/2018 06:00	11,651	418068,149	0,878	18,875	11129,665	43,262
11/05/2018 07:00	5,241	427390,836	0,785	16,332	12541,636	50,003
11/05/2018 08:00	2,07	425964,583	0,816	15,925	12551,063	50,001
11/05/2018 09:00	2,006	427205,72	0,821	15,756	12540,638	50,001
11/05/2018 10:00	2,01	427747,49	0,81	15,654	12521,08	50,001
11/05/2018 11:00	1,998	426817,422	0,814	15,659	12501,206	49,948
11/05/2018 12:00	1,973	429300,928	0,816	15,857	12477,624	49,906
11/05/2018 13:00	1,962	430010,601	0,822	15,984	12435,847	49,757
11/05/2018 14:00	1,958	428529,074	0,737	15,996	12384,545	49,627
11/05/2018 15:00	1,894	427695,512	0,732	15,969	12343,086	49,591
11/05/2018 16:00	3,718	413776,165	0,754	15,566	11154,645	43,672
11/05/2018 17:00	2,033	427719,417	0,735	14,482	11902,407	47,395
11/05/2018 18:00	1,958	427800,084	0,72	15,778	12482,112	49,997
11/05/2018 19:00	1,883	427539,875	0,743	15,788	12500,021	49,999
11/05/2018 20:00	1,941	429441,305	0,757	15,989	12392,502	49,288
11/05/2018 21:00	1,894	429702,29	0,771	15,763	12509,472	50
11/05/2018 22:00	2,008	430418,025	0,772	15,911	12506,201	49,999
11/05/2018 23:00	1,885	428724,916	0,766	15,915	12506,619	49,997
12/05/2018 00:00	1,87	429318,201	0,768	15,987	12501,919	50
12/05/2018 01:00	1,994	428863,794	0,766	16,067	12508,815	49,997
12/05/2018 02:00	2,035	427530,352	0,77	16,039	12511,126	50,002
12/05/2018 03:00	1,973	429079,393	0,774	16,125	12509,248	50,003
12/05/2018 04:00	16,143	420373,077	0,77	16,042	12146,994	47,736
12/05/2018 05:00	115,012	2461,748	1,794	5,571	750,33	0,2
12/05/2018 06:00	1,609	0	7,343	0,156	0	0
12/05/2018 07:00	3,612	0	3,692	0,08	0	0
12/05/2018 08:00	0,693	0	204,094	0,053	0	0
12/05/2018 09:00	0,777	0	490,566	0,063	0	0
12/05/2018 10:00	0,765	0	13,806	0,041	0	0
12/05/2018 11:00	0,77	0	592,249	0,045	0	0
12/05/2018 12:00	0,823	0	630,05	0,048	0	0
12/05/2018 13:00	0,706	0	623,919	0,03	0	0
12/05/2018 14:00	0,653	0	559,851	0,024	0	0

12/05/2018 15:00	0,592	0	17,887	0,012	0	0
12/05/2018 16:00	0,589	0	11,149	0,008	0	0
12/05/2018 17:00	0,656	0	98,94	0,008	0	0
12/05/2018 18:00	0,717	0	189,35	0,012	72,313	0
12/05/2018 19:00	0,732	0	27,249	0,012	0	0
12/05/2018 20:00	255,37	0	2,452	5,6	4606,945	11,989
12/05/2018 21:00	559,022	73084,991	0,295	11,428	7277,028	22,003
12/05/2018 22:00	565,547	302490,115	0,937	11,459	7293,182	22,002
12/05/2018 23:00	127,134	397413,704	0,98	13,477	11251,768	43,325
13/05/2018 00:00	2,145	426755,768	0,783	14,224	12567,519	49,997
13/05/2018 01:00	2,132	426994,088	0,776	14,193	12567,336	49,997
13/05/2018 02:00	2,058	424978,048	0,779	15,884	12568,752	50,001
13/05/2018 03:00	1,959	426889,327	0,768	17,225	12568,3	49,998
13/05/2018 04:00	1,981	427142,655	0,763	17,263	12570,037	49,999
13/05/2018 05:00	2,013	421970,106	0,766	17,339	12570,528	49,999
13/05/2018 06:00	1,987	428478,733	0,762	17,286	12576,729	50,002
13/05/2018 07:00	6,624	428801,443	0,734	17,657	12259,873	48,338
13/05/2018 08:00	2,323	427829,664	0,78	16,697	12089,191	47,669
13/05/2018 09:00	2,197	428272,41	0,782	16,575	12152,886	47,999
13/05/2018 10:00	2,127	428535,847	0,782	16,816	12143,821	47,998
13/05/2018 11:00	2,096	427506,329	0,765	16,999	12138,318	47,998
13/05/2018 12:00	2,083	427741,553	0,763	16,991	12140,203	48
13/05/2018 13:00	2,099	429678,454	0,831	16,815	12146,545	48
13/05/2018 14:00	11,924	414207,628	0,854	16,177	11112,838	42,736
13/05/2018 15:00	3,472	424900,095	0,869	18,389	11518,228	44,996
13/05/2018 16:00	2,497	424930,726	0,849	15,97	12307,199	48,96
13/05/2018 17:00	2,026	421446,221	0,836	15,789	12556,292	50,001
13/05/2018 18:00	2,144	422713,412	0,83	15,439	12556,284	50,001
13/05/2018 19:00	2,175	423357,596	0,834	15,303	12560,39	50,004
13/05/2018 20:00	2,208	423238,072	0,838	15,152	12559,645	49,997
13/05/2018 21:00	2,218	423113,457	0,856	15,155	12556,028	50,002
13/05/2018 22:00	2,228	424367,193	0,842	15,117	12556,647	50,001
13/05/2018 23:00	2,106	423971,305	0,853	15,139	12554,845	50
14/05/2018 00:00	2,136	426221,967	0,844	15,028	12553,356	49,996
14/05/2018 01:00	2,226	426712,563	0,839	14,983	12558,885	50,003
14/05/2018 02:00	2,272	424982,042	0,841	15,299	12561,621	50,001
14/05/2018 03:00	2,171	427230,285	0,851	17,809	12568,275	49,998
14/05/2018 04:00	2,098	428154,828	0,858	17,899	12563,484	49,996
14/05/2018 05:00	2,169	426415,767	0,849	18,004	12558,151	50
14/05/2018 06:00	2,098	429057,89	0,852	18,194	12545,231	49,997
14/05/2018 07:00	5,484	429912,589	0,814	18,22	12570,093	50
14/05/2018 08:00	2,211	428607,662	0,864	17,798	12568,9	49,998
14/05/2018 09:00	2,094	430360,469	0,857	17,625	12560,785	49,998
14/05/2018 10:00	2,137	429969,73	0,837	15,174	12539,04	50,002
14/05/2018 11:00	2,066	429572,102	0,829	14,842	12532,384	49,997
14/05/2018 12:00	2,04	428370,96	0,825	15,289	12532,948	49,997
14/05/2018 13:00	1,995	428523,239	0,819	15,152	12529,034	50
14/05/2018 14:00	1,968	428329,841	0,798	15,375	12527,466	50,002
14/05/2018 15:00	1,971	428716,759	0,796	15,718	12526,829	49,999
14/05/2018 16:00	1,976	429331,71	0,811	15,722	12531,453	50
14/05/2018 17:00	2,017	428964,016	0,809	15,658	12541,843	50,003
14/05/2018 18:00	2,057	427056,109	0,808	15,451	12543,857	50,003
14/05/2018 19:00	2,067	427636,815	0,812	15,414	12548,272	50
14/05/2018 20:00	2,061	427898,18	0,843	15,195	12544,955	50,002
14/05/2018 21:00	2,218	426580,814	0,835	15,865	12545,976	50
14/05/2018 22:00	2,239	426847,676	0,839	15,717	12548,658	49,996
14/05/2018 23:00	2,224	425835,593	0,838	15,218	12559,824	49,998
15/05/2018 00:00	2,096	427466,383	0,852	14,827	12558,171	50,003
15/05/2018 01:00	2,18	427536,503	0,857	14,672	12553,265	50,001
15/05/2018 02:00	2,332	426174,197	0,82	17,019	12552,182	49,998
15/05/2018 03:00	2,241	428126,53	0,825	17,896	12552,024	49,998
15/05/2018 04:00	2,123	428065,798	0,823	18,027	12541,907	50,002
15/05/2018 05:00	2,127	425793,116	0,824	18,221	12543,531	49,999
15/05/2018 06:00	2,168	426419,949	0,815	18,156	12528,633	50,002
15/05/2018 07:00	5,542	426772,564	0,766	17,113	12549,121	50,004
15/05/2018 08:00	2,31	425213,592	0,813	15,456	12552,768	50
15/05/2018 09:00	2,169	427649,148	0,823	15,658	12542,359	50
15/05/2018 10:00	2,121	427822,565	0,794	15,056	12539,768	50,005
15/05/2018 11:00	2,196	428654,922	0,8	15,29	12540,663	49,999
15/05/2018 12:00	2,181	427976,933	0,799	15,721	12540,574	50,005
15/05/2018 13:00	2,149	429111,502	0,827	15,922	12541,248	50,001
15/05/2018 14:00	2,185	428820,044	0,802	16,016	12541,803	49,998
15/05/2018 15:00	2,137	429330,461	0,798	15,882	12544,349	49,994
15/05/2018 16:00	2,149	428568	0,809	15,959	12549,664	49,996
15/05/2018 17:00	2,229	428014,139	0,809	15,872	12548,899	50
15/05/2018 18:00	2,34	426889,41	0,802	15,924	12548,351	49,999
15/05/2018 19:00	2,429	427143,35	0,804	15,891	12555,141	50,001
15/05/2018 20:00	2,516	427360,376	0,813	15,751	12557,218	50,001
15/05/2018 21:00	2,405	428370,54	0,802	15,795	12558,07	50,001
15/05/2018 22:00	2,227	428503,624	0,815	15,451	12534,95	49,982
15/05/2018 23:00	2,347	425498,258	0,817	15,302	12533,557	50,003
16/05/2018 00:00	2,517	425953,597	0,807	15,605	12546,446	50,001
16/05/2018 01:00	2,422	425914,969	0,821	15,282	12542,762	50,002
16/05/2018 02:00	3,295	400689,519	0,84	14,388	10813,897	41,306
16/05/2018 03:00	3,048	403533,192	0,868	14,464	10822,273	41,563
16/05/2018 04:00	2,357	427211,627	0,837	15,193	12544,002	50,001
16/05/2018 05:00	2,275	429270,463	0,803	15,155	12535,863	50,001
16/05/2018 06:00	2,354	428731,632	0,813	14,994	12518,246	49,999
16/05/2018 07:00	5,446	428523,842	0,762	15,374	12544,613	50,002
16/05/2018 08:00	2,388	427382,978	0,8	15,159	12547,078	50
16/05/2018 09:00	2,434	427027,628	0,815	15,372	12541,761	50,003
16/05/2018 10:00	2,353	429019,062	0,83	15,482	12537,233	49,996
16/05/2018 11:00	2,302	423736,855	0,827	16,269	12269,464	48,532
16/05/2018 12:00	2,215	436347,176	0,826	17,385	12531,12	49,983
16/05/2018 13:00	2,156	438872,096	0,79	17,554	12522,753	50,001
16/05/2018 14:00	2,233	437126,392	0,79	17,587	12526,773	49,999
16/05/2018 15:00	2,214	435050,444	0,796	17,428	12529,616	50,003
16/05/2018 16:00	2,252	434575,398	0,789	17,33	12533,712	50
16/05/2018 17:00	2,263	432857,558	0,795	17,326	12539,821	50,001
16/05/2018 18:00	2,274	430479,032	0,781	17,346	12539,624	50,002
16/05/2018 19:00	2,315	430736,336	0,79	16,902	12543,089	49,997
16/05/2018 20:00		0	0	0	0	0

16/05/2018 21:00		0	0	0	0	0
16/05/2018 22:00		0	0	0	0	0
16/05/2018 23:00		0	13,869	0,228	12551,824	7,446
17/05/2018 00:00	1,117	0	11,392	0,174	11206,172	0
17/05/2018 01:00	0,858	0	26,555	0,115	0	0
17/05/2018 02:00	48,212	0	4,821	2,311	2659,084	5,585
17/05/2018 03:00	177,905	0	0,432	3,406	7294,174	22,001
17/05/2018 04:00	503,464	24677,48	0,2	10,182	7286,401	22,001
17/05/2018 05:00	282,291	345776,283	0,937	13,259	9507,031	34,171
17/05/2018 06:00	2,289	427561,31	0,8	16,87	12556,736	49,998
17/05/2018 07:00	8,618	427096,571	0,77	18,626	12567,406	49,998
17/05/2018 08:00	2,512	426991,623	0,813	17,949	12575,571	49,999
17/05/2018 09:00	2,328	426209,785	0,776	17,333	12573,431	50,001
17/05/2018 10:00	2,257	426491,487	0,749	17,106	12556,128	50,004
17/05/2018 11:00	2,202	426241,167	0,744	15,825	12540,515	49,999
17/05/2018 12:00	2,103	427015,631	0,727	15,268	12527,262	49,976
17/05/2018 13:00	2,108	426926,559	0,75	15,408	12533,389	49,998
17/05/2018 14:00	2,075	426715,181	0,733	16,16	12509,674	49,95
17/05/2018 15:00	2,091	425541,592	0,736	17,402	12519,475	49,998
17/05/2018 16:00	2,109	425563,704	0,734	17,353	12515,548	50,002
17/05/2018 17:00	2,095	427900,059	0,726	17,253	12533,321	49,996
17/05/2018 18:00	2,228	428983,994	0,724	17,365	12538,305	50
17/05/2018 19:00	2,21	428610,949	0,731	17,391	12546,46	50,003
17/05/2018 20:00	2,182	428391,947	0,766	17,159	12542,642	50
17/05/2018 21:00	2,147	428276,881	0,792	17,187	12562,087	49,997
17/05/2018 22:00	2,247	427761,71	0,773	17,989	12574,665	49,999
17/05/2018 23:00	2,158	427156,448	0,773	18,001	12572,079	50,001
18/05/2018 00:00	2,2	427237,672	0,779	18,261	12567,014	49,999
18/05/2018 01:00	2,149	428119,178	0,783	18,25	12567,369	49,998
18/05/2018 02:00	2,287	428377,416	0,777	18,843	12560,187	49,994
18/05/2018 03:00	2,255	428280,203	0,749	19,295	12556,908	50,003
18/05/2018 04:00	2,254	428266,704	0,758	19,193	12567,596	49,998
18/05/2018 05:00	2,119	427625,583	0,77	19,371	12561,322	50
18/05/2018 06:00	2,199	428160,533	0,762	19,433	12545,585	49,998
18/05/2018 07:00	7,962	427733,025	0,722	19,409	12569,035	50,002
18/05/2018 08:00	2,373	427747,676	0,769	19,255	12584,901	50
18/05/2018 09:00	2,273	428558,572	0,785	17,388	12564,109	49,999
18/05/2018 10:00	2,241	430139,444	0,778	16,806	12557,869	50
18/05/2018 11:00	2,112	432094,064	0,786	17,137	12556,8	50,001
18/05/2018 12:00	2,109	433451,588	0,786	17,161	12552,807	50,001
18/05/2018 13:00		433724,118	0,808	15,506	12517,203	50,001
18/05/2018 14:00	2,066	434687,72	0,833	15,54	12491,204	50
18/05/2018 15:00	2,047	434906,66	0,826	15,751	12468,465	50
18/05/2018 16:00	2,061	434979,504	0,834	15,942	12452,873	49,998
18/05/2018 17:00	2,078	434945,436	0,844	15,818	12453,977	49,971
18/05/2018 18:00	2,138	434649,799	0,84	17,048	12484,235	49,999
18/05/2018 19:00	2,078	434480,963	0,867	17,151	12470,946	50,002
18/05/2018 20:00	2,096	433587,163	0,846	17,198	12470,616	49,999
18/05/2018 21:00	2,111	433488,43	0,855	17,335	12460,577	50,002
18/05/2018 22:00	2,24	433516,248	0,871	16,852	12423,311	50,004
18/05/2018 23:00	2,208	433797,056	0,864	16,788	12435,742	50
19/05/2018 00:00	2,187	433799,168	0,864	16,613	12443,033	50,004
19/05/2018 01:00	2,229	433612,631	0,835	16,359	12441,958	49,999
19/05/2018 02:00	2,257	432764,614	0,832	17,575	12438,135	50,001
19/05/2018 03:00	2,248	432051,837	0,842	18,132	12440,893	50,001
19/05/2018 04:00	2,288	431515,119	0,843	17,864	12433,794	50,001
19/05/2018 05:00	2,378	427119,252	0,86	17,965	12417,027	49,997
19/05/2018 06:00	2,331	428603,312	0,837	18,249	12362,744	49,997
19/05/2018 07:00	7,961	427566,273	0,783	18,169	12329,541	49,999
19/05/2018 08:00	2,121	427629,743	0,846	17,971	12300,502	49,989
19/05/2018 09:00	2,304	426824,769	0,834	17,656	12281,934	49,996
19/05/2018 10:00	2,213	427572,624	0,833	17,806	12260,048	49,998
19/05/2018 11:00	2,214	427869,871	0,835	17,885	12255,264	50
19/05/2018 12:00	2,22	427538,243	0,857	18,506	12198,289	49,628
19/05/2018 13:00	2,261	427759,372	0,855	18,545	12013,191	48,67
19/05/2018 14:00	2,229	427510,454	0,844	17,782	12037,415	48,831
19/05/2018 15:00	2,034	423538,3	0,859	15,394	12248,091	49,999
19/05/2018 16:00	2,011	424115,522	0,845	15,097	12278,505	50,005
19/05/2018 17:00	2,163	424532,754	0,849	15,195	12318,519	49,985
19/05/2018 18:00	2,133	425672,136	0,864	14,89	12339,317	50
19/05/2018 19:00	2,151	425777,68	0,862	17,558	12331,627	49,998
19/05/2018 20:00	2,104	426046,716	0,867	18,034	12329,047	50
19/05/2018 21:00	2,107	425406,488	0,861	18,247	12328,875	49,999
19/05/2018 22:00	2,114	425967,651	0,863	18,587	12331,078	49,998
19/05/2018 23:00	2,145	425654,585	0,867	18,651	12340,828	50,001
20/05/2018 00:00	2,154	426341,275	0,883	18,769	12341,872	49,999
20/05/2018 01:00	2,11	426520,81	0,873	18,829	12347,144	50
20/05/2018 02:00	2,131	426648,375	0,863	19,09	12342,315	50,004
20/05/2018 03:00	7,647	424839,039	0,873	18,067	11924,529	47,839
20/05/2018 04:00	22,536	419760,335	0,904	15,374	10740,887	42
20/05/2018 05:00	12,397	427124,105	0,89	16,93	11420,799	45,435
20/05/2018 06:00	2,146	427375,509	0,864	18,242	12328,493	49,789
20/05/2018 07:00	7,616	427570,694	0,81	17,679	12372,948	49,998
20/05/2018 08:00	2,198	427369,248	0,868	17,647	12367,024	49,998
20/05/2018 09:00	2,231	427619,985	0,832	17,894	12358,978	49,999
20/05/2018 10:00	2,219	427757,863	0,825	17,817	12329,894	50,001
20/05/2018 11:00	2,164	429216,432	0,79	16,713	12325,209	49,999
20/05/2018 12:00	2,117	428696,507	0,799	14,723	12318,733	49,986
20/05/2018 13:00	2,079	428397,526	0,826	14,722	12300,622	50,001
20/05/2018 14:00	2,028	428618,44	0,81	14,882	12282,918	50,002
20/05/2018 15:00	1,997	428538,932	0,806	14,836	12262,595	49,998
20/05/2018 16:00	2,018	429338,369	0,799	14,842	12276,409	49,979
20/05/2018 17:00	8,871	420928,203	0,808	13,944	11738,443	46,977
20/05/2018 18:00	48,903	373478,169	0,883	9,854	9342,194	35,004
20/05/2018 19:00	31,888	390774,925	0,883	12,065	10075,401	38,704
20/05/2018 20:00	4,795	420749,544	0,836	15,587	11438,702	45,248
20/05/2018 21:00	41,638	377714,957	0,909	10,187	9524,177	35,777
20/05/2018 22:00	14,397	417474,958	0,892	16,607	10844,836	42,419
20/05/2018 23:00	2,513	422873,535	0,863	15,849	11009,384	43,104
21/05/2018 00:00	2,414	429409,218	0,852	16,81	11911,139	47,73
21/05/2018 01:00	2,243	432423,987	0,83	17,552	12373,191	50,002
21/05/2018 02:00	2,396	430438,74	0,833	18,047	12056,25	48,459

21/05/2018 03:00	2,349	428387,043	0,834	16,668	11177,741	43,985
21/05/2018 04:00	2,262	427269,131	0,869	16,659	11160,222	43,876
21/05/2018 05:00	2,339	416332,257	0,867	16,64	11178,055	43,998
21/05/2018 06:00	2,315	427494,085	0,849	16,539	11183,901	44
21/05/2018 07:00	8,632	427397,35	0,798	16,533	11188,094	44,001
21/05/2018 08:00	17,473	419024,434	0,847	16,222	11137,447	43,837
21/05/2018 09:00	2,377	423565,436	0,824	17,616	12365,523	49,993
21/05/2018 10:00	2,163	424190,302	0,804	17,035	12347,016	50,001
21/05/2018 11:00	2,116	424527,611	0,795	15,947	12336,418	50,001
21/05/2018 12:00	2,068	426987,683	0,781	14,927	12330,224	50,004
21/05/2018 13:00	2,046	427110,998	0,77	15,622	12337,913	50,001
21/05/2018 14:00	2,053	427172,575	0,772	16,086	12331,9	49,999
21/05/2018 15:00	2,046	424820,211	0,772	16,1	12325,291	49,999
21/05/2018 16:00	2,039	425230,951	0,77	15,776	12328,394	50,001
21/05/2018 17:00	2,096	425107,675	0,767	15,81	12344,069	50,002
21/05/2018 18:00	2,236	426211,204	0,772	15,527	12363,997	50,001
21/05/2018 19:00	2,236	426487,493	0,781	15,039	12377,277	50,002
21/05/2018 20:00	2,149	426489,105	0,801	14,66	12379,36	49,997
21/05/2018 21:00	2,205	422572,764	0,833	15,301	12385,915	50,002
21/05/2018 22:00	2,207	423154,528	0,834	17,412	12398,081	49,994
21/05/2018 23:00	2,122	424924,327	0,833	17,502	12394,621	49,997
22/05/2018 00:00	2,137	426027,559	0,831	17,737	12386,537	49,999
22/05/2018 01:00	2,329	426631,055	0,805	17,75	12392,079	50,001
22/05/2018 02:00	2,273	424951,288	0,81	17,2	12401,031	50,002
22/05/2018 03:00	2,194	425208,68	0,798	17,979	12391,859	49,994
22/05/2018 04:00	2,352	425191,689	0,804	17,6	12402,287	49,999
22/05/2018 05:00	2,183	421822,759	0,802	17,723	12395,112	49,997
22/05/2018 06:00	2,316	426763,415	0,777	17,378	12386,434	50,001
22/05/2018 07:00	8,51	427085,674	0,752	17,283	12404,731	49,999
22/05/2018 08:00	2,643	427110,143	0,799	17,055	12402,488	50,002
22/05/2018 09:00	2,603	425125,497	0,803	16,915	12393,189	50,002
22/05/2018 10:00	2,18	425662,246	0,823	15,095	12360,857	50
22/05/2018 11:00	2,204	426200,595	0,814	15,973	12340,213	49,975
22/05/2018 12:00	2,166	427605,933	0,815	16,307	12335,94	49,999
22/05/2018 13:00	2,181	427575,462	0,816	16,399	12312,976	49,855
22/05/2018 14:00	2,145	427525,792	0,806	16,618	12282,497	49,826
22/05/2018 15:00	2,085	426936,567	0,8	16,334	12304,017	49,997
22/05/2018 16:00	2,074	427196,716	0,793	15,844	12294,432	50
22/05/2018 17:00	2,159	426921,758	0,791	15,911	12321,362	50,003
22/05/2018 18:00	2,356	422194,671	0,817	15,568	12348,2	49,998
22/05/2018 19:00	2,115	422952,122	0,844	14,804	12353,37	49,998
22/05/2018 20:00	2,167	422865,368	0,864	15,726	12360,99	50
22/05/2018 21:00	2,17	427080,006	0,84	17,214	12371,995	49,999
22/05/2018 22:00	2,13	427688,6	0,843	17,226	12372,066	50
22/05/2018 23:00	2,164	427193,867	0,835	17,35	12371,978	50
23/05/2018 00:00	2,141	426898,948	0,852	17,431	12368,725	49,998
23/05/2018 01:00	2,143	427003,481	0,841	17,495	12369,406	50,001
23/05/2018 02:00	2,286	426678,096	0,833	17,985	12367,646	50,003
23/05/2018 03:00	2,178	426854,192	0,839	18,003	12370,295	49,995
23/05/2018 04:00	2,122	427050,933	0,849	17,846	12365,968	49,997
23/05/2018 05:00	2,162	423618,788	0,85	17,908	12365,803	50,002
23/05/2018 06:00	2,268	426274,603	0,839	17,911	12349,789	49,997
23/05/2018 07:00	7,861	426323,225	0,791	18,034	12375,599	50,004
23/05/2018 08:00	2,426	426682,301	0,845	17,934	12390,674	49,99
23/05/2018 09:00	2,445	426423,815	0,826	17,356	12374,837	49,995
23/05/2018 10:00	2,363	427130,853	0,798	17,008	12349,803	50
23/05/2018 11:00	2,198	426787,512	0,797	15,355	12331,05	49,97
23/05/2018 12:00	2,223	427962,7	0,806	16,09	12332,903	50,001
23/05/2018 13:00	2,204	427225,84	0,797	16,268	12329,513	49,998
23/05/2018 14:00	2,175	428157,232	0,797	16,152	12306,843	50,002
23/05/2018 15:00	2,139	425709,35	0,799	16,138	12292,334	49,995
23/05/2018 16:00	2,232	426105,612	0,795	16,128	12290,955	50
23/05/2018 17:00	2,278	426105,14	0,803	16,037	12320,896	49,999
23/05/2018 18:00	2,406	425352,031	0,808	15,787	12357,078	49,997
23/05/2018 19:00	2,338	425685,336	0,826	15,122	12370,532	49,998
23/05/2018 20:00	2,107	425781,684	0,845	14,776	12359,461	49,992
23/05/2018 21:00	2,123	426737,787	0,83	14,581	12365,737	50,003
23/05/2018 22:00	2,161	426752,26	0,827	14,756	12369,465	49,987
23/05/2018 23:00	2,317	423951,05	0,833	16,151	12378,655	50,006
24/05/2018 00:00	2,186	425221,312	0,844	17,578	12379,846	49,994
24/05/2018 01:00	2,28	425435,862	0,851	16,741	12369,752	49,961
24/05/2018 02:00	2,164	423939,253	0,856	15,99	12372,569	49,975
24/05/2018 03:00	2,251	424201,771	0,843	16,617	12377,857	49,987
24/05/2018 04:00	2,247	424436,035	0,84	17,667	12365,477	49,94
24/05/2018 05:00	2,264	420283,568	0,837	17,929	12367,366	49,997
24/05/2018 06:00	2,239	427069,642	0,834	17,739	12356,019	49,984
24/05/2018 07:00	7,804	427416,35	0,775	17,217	12378,993	49,981
24/05/2018 08:00	2,522	427632,427	0,813	17,583	12382,752	49,991
24/05/2018 09:00	2,428	426847,415	0,808	16,483	12373,833	49,986
24/05/2018 10:00	2,252	427061,776	0,784	15,426	12333,834	49,914
24/05/2018 11:00	2,286	427203,919	0,771	15,587	12335,776	49,995
24/05/2018 12:00	2,219	428368,331	0,788	15,989	12246,891	49,757
24/05/2018 13:00		427634,312	0,781	15,454	12318,611	49,998
24/05/2018 14:00	2,148	427403,408	0,784	14,905	12305,781	50
24/05/2018 15:00	2,04	427139,289	0,773	14,374	12293,464	49,996
24/05/2018 16:00	2,029	426205,508	0,779	14,285	12281,727	49,995
24/05/2018 17:00	2,093	427116,162	0,777	14,295	12299,336	49,972
24/05/2018 18:00	2,194	425671,167	0,776	14,21	12347,465	49,999
24/05/2018 19:00	2,086	426718,952	0,8	13,85	12366,795	50,003
24/05/2018 20:00	2,067	428339,592	0,812	13,72	12371,398	50,001
24/05/2018 21:00	2,105	426799,82	0,814	16,004	12384,54	49,999
24/05/2018 22:00	2,113	427862,914	0,822	16,526	12398,924	50,001
24/05/2018 23:00	2,101	421687,902	0,84	16,644	12404,036	49,999
25/05/2018 00:00	2,12	420310,188	0,833	16,746	12410,578	49,996
25/05/2018 01:00	2,109	421122,905	0,842	16,806	12407,81	49,998
25/05/2018 02:00	2,123	422250,948	0,83	16,846	12413,678	50,001
25/05/2018 03:00	2,071	424634,039	0,818	16,942	12408,336	49,997
25/05/2018 04:00	2,12	424516,546	0,813	16,999	12410,758	50
25/05/2018 05:00	2,091	418087,164	0,822	17,019	12412,795	49,996
25/05/2018 06:00	2,074	425493,407	0,806	17,034	12386,94	49,937
25/05/2018 07:00	8,484	425702,379	0,766	16,698	12418,233	49,942
25/05/2018 08:00	2,374	426223,308	0,799	16,952	12426,679	50,001

25/05/2018 09:00	2,415	426136,396	0,808	16,469	12414,151	50
25/05/2018 10:00	2,239	426524,134	0,818	16,043	12397,741	50,001
25/05/2018 11:00	2,212	428227,182	0,826	13,874	12360,421	49,851
25/05/2018 12:00	2,16	429515,375	0,812	13,916	12342,33	49,832
25/05/2018 13:00	11,802	416105,182	0,836	13,077	11600,291	46,005
25/05/2018 14:00	37,944	367779,969	0,914	9,123	9370,8	34,997
25/05/2018 15:00	37,927	367517,788	0,908	9,084	9366,522	35,002
25/05/2018 16:00	36,439	368871,292	0,908	9,087	9365,013	34,996
25/05/2018 17:00	26,312	388758,182	0,881	10,734	10236,436	39,348
25/05/2018 18:00	2,418	431257,94	0,81	13,844	12422,992	49,997
25/05/2018 19:00	2,397	430589,509	0,824	13,473	12435,312	50
25/05/2018 20:00	2,266	429895,667	0,843	13,543	12442,19	49,994
25/05/2018 21:00	2,268	428857,75	0,854	15,643	12442,43	49,98
25/05/2018 22:00	2,392	429118,946	0,848	16,508	12430,368	49,995
25/05/2018 23:00	2,401	428750,799	0,838	16,398	12436,428	50
26/05/2018 00:00	2,361	428950,035	0,84	16,51	12446,526	50,001
26/05/2018 01:00	2,482	428766,529	0,82	16,715	12443,754	49,986
26/05/2018 02:00	2,525	428701,928	0,822	16,894	12452,447	49,999
26/05/2018 03:00	2,337	428963,603	0,815	16,87	12457,941	50,001
26/05/2018 04:00	2,492	429180,484	0,816	17,865	12454,686	49,992
26/05/2018 05:00	2,467	427435,438	0,827	19,86	12438,259	50
26/05/2018 06:00	2,69	428809,989	0,817	20,297	12440,868	50,003
26/05/2018 07:00	8,575	428777,026	0,77	20,059	12438,554	50,004
26/05/2018 08:00	2,478	428542,184	0,81	20,079	12433,783	49,999
26/05/2018 09:00	2,419	424079,786	0,841	18,762	12430,017	49,997
26/05/2018 10:00	2,508	424210,561	0,866	18,08	12438,311	50
26/05/2018 11:00	2,5	424211,92	0,85	18,003	12429,286	50
26/05/2018 12:00	2,376	425361,959	0,865	15,701	12419,259	50
26/05/2018 13:00	2,32	425411,829	0,862	14,627	12411,755	50,006
26/05/2018 14:00	2,357	425254,427	0,855	15,129	12408,935	50
26/05/2018 15:00	2,267	424402,367	0,854	14,506	12404,391	50,003
26/05/2018 16:00	2,165	424849,664	0,853	14,329	12405,649	50,002
26/05/2018 17:00	2,184	424748,646	0,842	14,238	12411,915	50
26/05/2018 18:00	2,358	423496,144	0,871	15,808	12434,795	49,999
26/05/2018 19:00	2,456	423690,34	0,889	17,419	12445,33	50
26/05/2018 20:00	2,401	423841,102	0,884	17,539	12447,969	50
26/05/2018 21:00	2,401	426435,279	0,861	17,381	12458,336	50,003
26/05/2018 22:00	2,429	427030,555	0,874	17,422	12463,267	50,001
26/05/2018 23:00	2,439	427266,847	0,885	17,48	12470,008	50,001
27/05/2018 00:00	2,317	426945,719	0,892	18,347	12464,642	50
27/05/2018 01:00	2,3	427162,862	0,915	18,289	12462,466	49,999
27/05/2018 02:00	2,352	422740,89	0,895	17,727	12467,252	49,999
27/05/2018 03:00	2,338	420640,09	0,915	17,687	12475,66	49,997
27/05/2018 04:00	2,308	421166,932	0,923	18,746	12467,573	49,998
27/05/2018 05:00	2,324	420626,712	0,9	18,266	12470,111	50,001
27/05/2018 06:00	2,238	425088,454	0,913	18,492	12466,836	49,999
27/05/2018 07:00	8,092	425711,991	0,833	18,532	12456,282	50,002
27/05/2018 08:00	2,626	425658,357	0,887	18,352	12458,129	50,002
27/05/2018 09:00	2,334	421848,468	0,866	18,087	12439,215	50,001
27/05/2018 10:00	2,303	422095,461	0,84	15,765	12412,513	50,003
27/05/2018 11:00	2,187	422354,332	0,853	15,98	12394,324	49,964
27/05/2018 12:00	2,23	425066,671	0,834	14,489	12386,47	49,987
27/05/2018 13:00	2,214	425300,437	0,841	13,474	12386,989	50,003
27/05/2018 14:00	2,188	425484,524	0,83	13,441	12377,772	49,999
27/05/2018 15:00	2,19	423374,558	0,827	13,405	12388,071	50,003
27/05/2018 16:00	2,172	423912,205	0,828	13,712	12391,005	49,999
27/05/2018 17:00	2,218	424239,548	0,841	13,892	12399,293	49,998
27/05/2018 18:00	2,306	423214,961	0,875	13,839	12416,733	50,002
27/05/2018 19:00	2,231	423978,551	0,858	13,938	12432,216	50
27/05/2018 20:00	2,389	424292,332	0,833	16,207	12439,446	50,002
27/05/2018 21:00	2,429	425582,632	0,82	16,204	12445,468	50,002
27/05/2018 22:00	2,204	426046,966	0,85	16,241	12443,939	49,999
27/05/2018 23:00	2,353	423491,278	0,866	16,395	12437,261	49,998
28/05/2018 00:00	2,374	423029,539	0,857	16,286	12440,795	50,001
28/05/2018 01:00	2,372	423061,6	0,861	16,254	12437,312	50,004
28/05/2018 02:00	2,348	422792,978	0,866	16,298	12433,771	50,001
28/05/2018 03:00	2,376	423411,964	0,845	16,396	12434,489	50
28/05/2018 04:00	2,341	423686,333	0,853	16,273	12440,712	49,999
28/05/2018 05:00	2,324	420427,666	0,842	16,296	12437,52	49,997
28/05/2018 06:00	2,333	422160,703	0,856	16,366	12425,342	49,999
28/05/2018 07:00	7,811	423754,221	0,819	16,163	12434,339	50
28/05/2018 08:00	2,367	424220,439	0,853	16,237	12439,74	50
28/05/2018 09:00	2,221	424598,334	0,842	14,342	12432,848	50
28/05/2018 10:00	2,396	426602,433	0,83	14,324	12429,627	50,002
28/05/2018 11:00	2,129	426241,024	0,849	14,754	12425,222	49,991
28/05/2018 12:00	2,14	427133,103	0,832	14,993	12406,184	50,001
28/05/2018 13:00	2,169	427532,743	0,84	14,454	12391,194	50,003
28/05/2018 14:00	2,208	425688,212	0,821	14,93	12250,257	49,056
28/05/2018 15:00	2,194	421764,828	0,832	14,248	12045,9	48,205
28/05/2018 16:00	2,185	425185,073	0,828	13,958	12424,965	49,999
28/05/2018 17:00	2,156	425260,194	0,829	14,095	12433,44	50,001
28/05/2018 18:00	2,19	428601,182	0,806	14,095	12433,395	49,998
28/05/2018 19:00	2,175	428650,11	0,835	13,85	12432,089	50
28/05/2018 20:00	2,349	428750,993	0,851	13,742	12432,953	50
28/05/2018 21:00	2,339	428518,579	0,841	13,684	12433,544	49,997
28/05/2018 22:00	2,429	428621,576	0,841	13,818	12438,073	49,996
28/05/2018 23:00	2,201	425625,611	0,865	13,719	12435,233	50,002
29/05/2018 00:00	2,225	423998,3	0,845	13,69	12431,955	50
29/05/2018 01:00	2,311	424154,544	0,847	14,84	12439,174	49,998
29/05/2018 02:00	2,311	426603,266	0,859	15,078	12439,038	50
29/05/2018 03:00	2,164	428794,554	0,846	15,652	12439,679	50,003
29/05/2018 04:00	2,131	429014,319	0,841	15,951	12438,33	50
29/05/2018 05:00	2,122	423516,25	0,862	15,947	12432,279	49,997
29/05/2018 06:00	2,092	428034,971	0,819	14,29	12410,28	49,997
29/05/2018 07:00	7,543	429182,845	0,767	14,153	12439,067	49,998
29/05/2018 08:00	2,106	430205,762	0,823	14,017	12445,419	49,999
29/05/2018 09:00	2,105	429312,673	0,86	13,735	12448,985	50,001
29/05/2018 10:00	2,059	430421,204	0,877	13,798	12447,734	49,999
29/05/2018 11:00	2,058	431399,723	0,873	14,318	12446,552	50,001
29/05/2018 12:00	2,155	431858,165	0,866	14,821	12453,359	50
29/05/2018 13:00	2,105	432488,161	0,877	14,17	12449,619	49,998
29/05/2018 14:00	2,11	432700,03	0,883	14,229	12444,664	50,005

29/05/2018 15:00	2,108	430162,493	0,89	14,122	12446,11	50,001
29/05/2018 16:00	2,06	430585,13	0,888	14,253	12438,366	50
29/05/2018 17:00	2,168	430704,648	0,883	14,118	12436,469	49,997
29/05/2018 18:00	2,259	427244,444	0,902	16,634	12439,415	50,001
29/05/2018 19:00	2,184	427609,656	0,895	16,897	12436,261	50,003
29/05/2018 20:00	2,101	428402,981	0,901	16,841	12442,427	50,001
29/05/2018 21:00	2,13	431699,884	0,885	16,863	12449,314	50,002
29/05/2018 22:00	2,175	429687,631	0,878	16,685	12460,024	49,998
29/05/2018 23:00	2,357	427336,208	0,884	16,562	12461,438	50,001
30/05/2018 00:00	2,322	425515,056	0,909	16,884	12456,19	49,999
30/05/2018 01:00	2,247	425328,538	0,895	16,879	12453,144	49,999
30/05/2018 02:00	2,32	426950,312	0,86	16,82	12451,153	50
30/05/2018 03:00	2,358	428528,389	0,867	16,644	12453,994	49,998
30/05/2018 04:00	2,315	428460,718	0,869	16,78	12447,82	49,996
30/05/2018 05:00	2,488	428473,437	0,856	16,614	12446,717	50
30/05/2018 06:00	2,458	428904,114	0,878	16,574	12432,456	49,997
30/05/2018 07:00	8,51	428816,407	0,848	16,653	12456,322	50,001
30/05/2018 08:00	2,453	428810,872	0,879	16,807	12462,164	50,005
30/05/2018 09:00	2,451	425381,774	0,869	16,638	12457,428	49,999
30/05/2018 10:00	2,384	426537,307	0,87	16,52	12445,324	50,005
30/05/2018 11:00	2,237	427148,508	0,879	16,501	12444,985	50
30/05/2018 12:00	234,834	361642,67	0,999	13,323	9531,813	34,524
30/05/2018 13:00	55,54	386464,563	0,982	12,181	10376,653	39,902
30/05/2018 14:00	2,406	429207,31	0,893	16,594	12437,605	49,997
30/05/2018 15:00	2,191	428569,063	0,912	16,546	12443,977	49,998
30/05/2018 16:00	2,206	427817,198	0,905	16,531	12450,448	50,001
30/05/2018 17:00	2,185	422070,621	0,835	16,384	12448,011	50,001
30/05/2018 18:00	2,196	427951,433	0,9	16,872	12443,623	49,998
30/05/2018 19:00	2,213	427996,174	0,882	17,016	12443,839	50,002
30/05/2018 20:00	2,246	427817,998	0,86	16,906	12445,654	50
30/05/2018 21:00	2,292	425420,483	0,884	16,965	12450,56	50,001
30/05/2018 22:00	2,227	426971,245	0,901	17,026	12454,541	50
30/05/2018 23:00	2,282	427718,878	0,88	17,03	12451,886	50,003
31/05/2018 00:00	2,289	428087,617	0,883	17,492	12450,128	49,997
31/05/2018 01:00	2,281	427945,205	0,862	17,374	12447,649	50,004
31/05/2018 02:00	2,256	427378,494	0,882	17,446	12455,62	49,998
31/05/2018 03:00	2,232	427779,702	0,888	17,711	12454,167	50
31/05/2018 04:00	2,241	428049,802	0,882	18,746	12452,543	49,998
31/05/2018 05:00	2,233	428350,882	0,874	19,035	12438,571	50,001
31/05/2018 06:00	2,248	427737,738	0,895	19,044	12422,15	50,002
31/05/2018 07:00	9,392	428408,653	0,833	19,277	12449,855	50,004
31/05/2018 08:00	2,307	427854,758	0,871	18,78	12481	50,001
31/05/2018 09:00	2,379	427408,306	0,867	19,724	12421,107	50,001
31/05/2018 10:00	2,324	428682,761	0,845	18,934	12317,98	50,001
31/05/2018 11:00	2,561	423949,812	0,831	17,382	12067,786	48,601
31/05/2018 12:00	33,76	382684,464	21,911	11,026	9699,607	36,714
31/05/2018 13:00	53,98	374563,621	1,09	9,792	9394,18	35
31/05/2018 14:00	64,855	373960,928	1,085	9,588	9407,23	34,999
31/05/2018 15:00	18,251	414219,648	1,025	15,386	11395,777	45,231
31/05/2018 16:00	2,17	430533,428	0,967	17,938	12357,746	49,997
31/05/2018 17:00	2,261	429901,451	0,975	18,815	12089,715	48,675
31/05/2018 18:00	2,483	428206,109	0,976	20,572	11965,837	47,998
31/05/2018 19:00	2,542	429108,208	0,954	20,995	11963,555	47,995
31/05/2018 20:00	2,495	428923,439	0,98	21,064	11963,735	47,999
31/05/2018 21:00	2,541	426184,713	0,991	20,945	11965,886	48,004
31/05/2018 22:00	2,823	427264,973	0,992	20,95	11964,862	47,999
31/05/2018 23:00	2,932	425315,184	1,015	21,007	11936,94	48
01/06/2018 00:00	2,805	423768,544	1,026	21,003	11935,823	49,999
01/06/2018 01:00	2,789	423984,889	1,038	20,993	11940,223	43,218
01/06/2018 02:00	2,767	421615,724	1,028	20,974	11940,61	41,003
01/06/2018 03:00	2,944	421435,402	1,021	21,016	11933,467	40,998
01/06/2018 04:00	2,769	421947,922	1,021	21,196	11902,877	41,002
01/06/2018 05:00	17,588	424421,897	1,044	17,561	11347,802	41
01/06/2018 06:00	2,447	430437,354	1,01	17,401	11510,113	41,607
01/06/2018 07:00	9,257	430083,353	0,949	17,543	11491,103	41,656
01/06/2018 08:00	8,037	411538,81	1,022	12,429	10528,267	41,266
01/06/2018 09:00	5,977	404785,344	1,017	11,944	10299,822	44,375
01/06/2018 10:00	156,932	364564,507	0,979	10,855	8884,823	46,882
01/06/2018 11:00	65,923	370983,311	1,067	10,557	9142,402	46,899
01/06/2018 12:00	33,16	371527,643	1,075	10,548	9241,838	46,901
01/06/2018 13:00	23,186	371365,463	1,057	10,948	9260,854	46,705
01/06/2018 14:00	21,499	371778,665	1,063	10,863	9264,043	46,886
01/06/2018 15:00	20,139	370434,666	1,069	11,122	9257,698	46,878
01/06/2018 16:00	20,124	370949,717	1,059	10,949	9265,316	46,898
01/06/2018 17:00	39,198	369456,896	1,061	10,783	9233,986	46,902
01/06/2018 18:00	217,141	346882,057	1,088	11,899	8399,58	44,365
01/06/2018 19:00	238,579	347407,464	1,117	11,515	8417,445	45,363
01/06/2018 20:00	250,511	348167,679	1,148	11,34	8430,827	48,685
01/06/2018 21:00	255,02	347988,317	1,146	11,447	8440,852	49,091
01/06/2018 22:00	264,169	349116,322	1,143	11,251	8453,337	49,305
01/06/2018 23:00	267,899	346437,175	1,174	11,144	8451,438	49,638
02/06/2018 00:00	272,695	345184,008	1,159	11,296	8458,984	47,669
02/06/2018 01:00	265,358	345193,303	1,186	11,324	8457,785	41,998
02/06/2018 02:00	370,061	334679,193	1,187	11,217	8101,743	42,003
02/06/2018 03:00	409,992	330571,674	1,191	11,326	7965,587	41,998
02/06/2018 04:00	405,403	330423,066	1,18	11,241	7963,071	44,391
02/06/2018 05:00	423,934	333421,122	1,147	11,162	7974,292	47,001
02/06/2018 06:00	422,768	335111,106	1,143	11,119	7974,704	47,002
02/06/2018 07:00	293,627	352703,862	1,042	11,409	8582,108	48,758
02/06/2018 08:00	404,438	334061,935	1,138	11,31	7980,701	49,997
02/06/2018 09:00	396,413	329722,348	1,165	11,408	7952,878	49,938
02/06/2018 10:00	368,13	329074,535	1,173	11,638	7918,759	33,798
02/06/2018 11:00	338,708	326286,19	1,147	11,74	7890,061	22
02/06/2018 12:00	318,897	325605,996	1,145	11,899	7875,637	21,995
02/06/2018 13:00	186,865	341417,847	1,111	11,844	8380,937	21,999
02/06/2018 14:00	281,941	326360,679	1,145	12,268	7845,948	21,996
02/06/2018 15:00	279,443	327510,704	1,142	12,286	7835,178	22,003
02/06/2018 16:00	280,566	328831,396	1,132	12,001	7834,426	22,001
02/06/2018 17:00	326,988	329918,903	1,133	11,515	7868,973	22,002
02/06/2018 18:00	441,927	319233,263	1,126	11,186	7603,33	39,579
02/06/2018 19:00	519,872	310365,923	1,163	11,166	7333,312	34,257
02/06/2018 20:00	493,278	316292,692	1,175	11,205	7476,116	30,003

02/06/2018 21:00	475,016	321926,171	1,149	11,179	7625,882	36,56
02/06/2018 22:00	489,342	322133,592	1,162	11,066	7634,115	40,817
02/06/2018 23:00	535,262	315338,246	1,18	10,891	7499,622	35,105
03/06/2018 00:00	552,394	314831,565	1,185	10,791	7513,214	44,776
03/06/2018 01:00	566,93	316224,301	1,208	10,685	7530,736	47,498
03/06/2018 02:00	572,778	317153,698	1,222	10,608	7543,568	47,499
03/06/2018 03:00	574,859	319085,1	1,177	10,656	7546,74	41,048
03/06/2018 04:00	573,724	319255,596	1,172	10,741	7539,738	38,003
03/06/2018 05:00	572,439	319145,072	1,171	10,749	7539,276	38,002
03/06/2018 06:00	566,913	319629,446	1,162	10,88	7538,133	32,766
03/06/2018 07:00	592,933	313566,118	1,082	10,895	7401,649	22,002
03/06/2018 08:00	592,352	313513,942	1,185	11,056	7380,135	24,991
03/06/2018 09:00	521,779	323902,317	1,19	11,039	7650,206	30,893
03/06/2018 10:00	491,532	324071,054	1,143	11,299	7645,735	36,964
03/06/2018 11:00	481,86	322684,324	1,179	11,224	7628,154	46,378
03/06/2018 12:00	467,674	321543,996	1,151	11,37	7610,218	48,317
03/06/2018 13:00	458,183	322030,352	1,146	11,41	7599,463	47,357
03/06/2018 14:00	443,162	322142,133	1,14	11,614	7577,535	48,253
03/06/2018 15:00	435,855	322238,061	1,146	11,73	7558,67	48,28
03/06/2018 16:00	440,236	321760,423	1,144	11,677	7559,26	48,577
03/06/2018 17:00	458,003	320827,607	1,142	11,419	7586,141	48,345
03/06/2018 18:00	475,279	321835,128	1,148	11,349	7616,987	48,629
03/06/2018 19:00	522,037	317651,569	1,182	11,381	7529,151	48,661
03/06/2018 20:00	535,73	317202,073	1,203	11,276	7509,506	48,985
03/06/2018 21:00	546,967	315981	1,202	11,287	7527,713	49,22
03/06/2018 22:00	550,374	317440,469	1,2	11,231	7547,469	48,634
03/06/2018 23:00	545,737	317314,613	1,198	11,49	7545,545	48,002
04/06/2018 00:00	542,512	317968,513	1,193	11,337	7536,744	47,999
04/06/2018 01:00	547,403	318218,531	1,189	11,268	7540,158	47,999
04/06/2018 02:00	548,119	318033,207	1,175	11,165	7540,21	47,997
04/06/2018 03:00	557,328	318249,214	1,176	11,05	7549,693	48,003
04/06/2018 04:00	563,06	317916,142	1,183	11,056	7549,693	48,001
04/06/2018 05:00	600,838	313014,735	1,175	11,355	7407,566	48,002
04/06/2018 06:00	177,67	81380,556	2,299	2,863	1703,126	44,53
04/06/2018 07:00	7,719	0	4,068	0,045	0	49,992
04/06/2018 08:00	1,43	0	377,85	0,032	0	50,002
04/06/2018 09:00	1,427	0	497,808	0,048	0	50,003
04/06/2018 10:00	1,334	0	0	0,036	0	49,661
04/06/2018 11:00	1,384	0	732,391	0,055	0	43,724
04/06/2018 12:00	1,464	0	762,931	0,072	87,337	27,127
04/06/2018 13:00	1,452	0	616,588	0,069	0	29,999
04/06/2018 14:00	1,685	0	593,381	0,08	0	44,813
04/06/2018 15:00	3,944	0	303,201	0,25	565,627	44,335
04/06/2018 16:00	482,649	214345,111	0,789	10,067	7323,358	48,016
04/06/2018 17:00	405,072	332080,516	1,176	10,961	7921,771	48,285
04/06/2018 18:00	25,456	403834,042	1,074	12,841	10288,609	48,597
04/06/2018 19:00	3,113	404308,177	1,062	13,132	10352,061	48,768
04/06/2018 20:00	2,735	403759,248	1,051	13,477	10360,092	48,012
04/06/2018 21:00	2,975	402039,472	1,082	13,442	10362,648	48,498
04/06/2018 22:00	3,564	404218,617	1,078	12,816	10359,487	48,497
04/06/2018 23:00	3,444	403666,756	1,052	13,22	10358,218	48,501
05/06/2018 00:00	2,499	402955,757	1,062	13,872	10367,966	48,498
05/06/2018 01:00	2,416	402889,706	1,071	13,962	10372,384	48,497
05/06/2018 02:00	2,644	401969,86	1,074	13,796	10371,225	48,499
05/06/2018 03:00	2,942	401924,973	1,079	13,513	10362,972	49,213
05/06/2018 04:00	3,898	403038,495	1,083	12,737	10355,277	49,499
05/06/2018 05:00	2,86	400719,563	1,082	13,508	10357,333	49,5
05/06/2018 06:00	2,39	402463,703	1,052	14,12	10348,92	49,562
05/06/2018 07:00	9,22	402582,35	0,98	14,275	10366,569	49,995
05/06/2018 08:00	2,731	404061,602	1,043	13,919	10386,81	49,998
05/06/2018 09:00	2,542	403919,666	1,037	13,986	10366,605	46,268
05/06/2018 10:00	2,494	401434,55	1,05	14,374	10363,819	43,66
05/06/2018 11:00	2,647	402598,526	0,992	14,314	10341,591	49,112
05/06/2018 12:00	2,458	399887,959	1,015	14,733	10342,057	48,474
05/06/2018 13:00	2,921	402280,37	1,001	14,292	10336,388	39,049
05/06/2018 14:00	66,804	375029,918	1,05	11,755	9344,251	47,999
05/06/2018 15:00	84,869	377762,783	1,045	13,532	9536,731	48
05/06/2018 16:00	2,6	398804,188	1,012	15,159	10327,51	39,303
05/06/2018 17:00	2,662	399259,164	1,019	15,077	10322,03	40,004
05/06/2018 18:00	2,852	399461,472	1,031	14,558	10310,236	41,045
05/06/2018 19:00	2,65	398750,813	1,027	14,52	10309,322	48,745
05/06/2018 20:00	2,843	400689,694	1,016	14,223	10293,621	49,018
05/06/2018 21:00	2,536	394365,075	1,047	14,477	10302,923	49,536
05/06/2018 22:00	2,301	394016,52	1,053	14,347	10313,864	49,667
05/06/2018 23:00	114,911	355974,806	1,107	12,053	8786,176	49,671
06/06/2018 00:00	228,57	336178,739	1,128	11,575	8145,041	49,782
06/06/2018 01:00	418,344	317136,594	1,149	10,977	7523,395	49,718
06/06/2018 02:00	420,949	317890,411	1,155	11,041	7528,628	49,837
06/06/2018 03:00	417,398	317511,709	1,163	11,056	7520,806	49,981
06/06/2018 04:00	437,515	319810,601	1,161	11,059	7534,466	49,774
06/06/2018 05:00	449,309	320091,849	1,161	11,248	7540,591	49,843
06/06/2018 06:00	449,033	319966,201	1,174	10,912	7526,819	49,98
06/06/2018 07:00	465,368	320888,24	1,102	10,929	7563,251	50,001
06/06/2018 08:00	467,628	321580,293	1,169	11,092	7580,979	49,996
06/06/2018 09:00	432,613	319390,346	1,182	11,283	7552,386	49,999
06/06/2018 10:00	311,354	331418,059	1,18	11,381	7913,502	50
06/06/2018 11:00	36,287	359879,003	1,046	11,206	8955,206	49,957
06/06/2018 12:00	44,872	363150,75	1,054	9,902	9030,655	49,957
06/06/2018 13:00	34,739	371476,532	1,059	9,266	9233,094	49,575
06/06/2018 14:00	20,298	387114,036	1,032	12,419	9745,112	49,801
06/06/2018 15:00	14,816	404231,116	1,035	14,058	10201,944	49,958
06/06/2018 16:00	4,638	428589,295	0,997	16,677	11069,314	49,957
06/06/2018 17:00	37,618	396371,941	1,016	14,151	10067,636	49,994
06/06/2018 18:00	39,313	367962,771	1,106	9,289	9230,127	49,997
06/06/2018 19:00	64,078	366447,763	1,105	9,47	9134,043	49,903
06/06/2018 20:00	72,988	364406,511	1,105	9,468	9034,206	50,003
06/06/2018 21:00	81,705	362936,985	1,112	9,642	9048,483	49,999
06/06/2018 22:00	120,014	355297,838	1,112	10,192	8800,885	50,004
06/06/2018 23:00	401,114	329294,569	1,16	10,761	7758,186	50,003
07/06/2018 00:00	450,311	321849,068	1,155	10,975	7549,078	50,001
07/06/2018 01:00	452,568	321187,99	1,156	10,95	7563,373	50,004
07/06/2018 02:00	458,377	321626,862	1,159	10,901	7569,047	50,001

07/06/2018 03:00	461,477	321538,601	1,151	10,744	7574,93	49,999
07/06/2018 04:00	484,967	324035,003	1,159	10,533	7588,628	50,002
07/06/2018 05:00	476,012	322775,561	1,126	10,738	7580,021	50,001
07/06/2018 06:00	462,376	323627,476	1,139	10,839	7560,793	50,004
07/06/2018 07:00	451,456	322913,558	1,059	10,845	7634,209	50,003
07/06/2018 08:00	224,738	348848,467	1,088	10,59	8435,712	50,004
07/06/2018 09:00	27,843	373513,484	1,086	10,166	9278,586	50
07/06/2018 10:00	14,487	371957,142	1,06	10,68	9229,024	49,926
07/06/2018 11:00	6,026	368522,037	0,997	11,108	9274,696	49,588
07/06/2018 12:00	3,692	366235,922	0,98	11,373	9281,961	48,869
07/06/2018 13:00	2,622	365773,93	0,959	12,148	9286,437	48,882
07/06/2018 14:00	2,627	366076,32	0,966	12,071	9274,47	48,683
07/06/2018 15:00	2,577	363139,559	0,982	12,406	9273,106	48,82
07/06/2018 16:00	15,586	354253,027	1,025	12,647	8897,204	48,716
07/06/2018 17:00	36,431	345943,228	1,036	12,376	8536,677	48,692
07/06/2018 18:00	34,376	354078,325	1,021	12,241	8761,389	49,135
07/06/2018 19:00	28,537	357248,229	1,043	11,823	8892,083	49,465
07/06/2018 20:00	27,501	357463,544	1,046	11,89	8894,564	49,694
07/06/2018 21:00	40,715	356930,891	1,056	11,722	8900,116	49,738
07/06/2018 22:00	27,999	364862,016	1,045	11,156	9139,37	49,826
07/06/2018 23:00	5,038	366318,387	1,017	11,455	9292,503	49,236
08/06/2018 00:00	15,436	362033,013	1,03	11,208	9110,329	49,757
08/06/2018 01:00	15,136	361832,968	1,031	11,247	9089,758	49,807
08/06/2018 02:00	27,078	363382,518	1,025	10,932	9090,635	49,812
08/06/2018 03:00	31,557	363778,331	1,004	10,817	9096,599	49,807
08/06/2018 04:00	25,76	363615,152	1,025	10,849	9092,958	45,12
08/06/2018 05:00	31,435	362858,963	1,036	10,794	9090,328	44,297
08/06/2018 06:00	29,594	365344,715	1,029	10,837	9093,097	44,302
08/06/2018 07:00	31,252	365455,695	1,02	10,846	9097,474	45,867
08/06/2018 08:00	32,096	365936,651	1,028	10,745	9098,452	49,995
08/06/2018 09:00	25,475	363284,623	0,967	11,096	9081,171	49,999
08/06/2018 10:00	10,641	361724,79	1,027	11,346	9043,242	49,613
08/06/2018 11:00	5,514	358902,122	0,947	11,559	9063,211	49,02
08/06/2018 12:00	15,38	350575,196	0,975	12,265	8779,053	48,806
08/06/2018 13:00	17,075	346121,728	0,995	12,613	8635,83	48,538
08/06/2018 14:00	27,991	343110,004	0,988	12,562	8486,694	48,736
08/06/2018 15:00	32,075	344879,702	0,982	12,524	8486,516	48,421
08/06/2018 16:00	33,09	349773,725	0,969	12,273	8601,197	48,882
08/06/2018 17:00	36,83	352136,305	0,969	12,276	8683,452	49,014
08/06/2018 18:00	26,148	355537,523	0,965	11,966	8818,393	49,054
08/06/2018 19:00	27,32	358340,726	0,967	11,688	8880,897	49,15
08/06/2018 20:00	28,762	358371,719	0,985	11,751	8876,697	49,651
08/06/2018 21:00	28,9	355706,154	1,003	11,628	8882,866	49,787
08/06/2018 22:00	30,511	355886,176	0,999	11,651	8884,047	49,964
08/06/2018 23:00	29,196	356549,311	1,005	11,627	8878,65	49,991
09/06/2018 00:00	35,709	358403,992	0,995	11,508	8874,047	49,95
09/06/2018 01:00	31,299	367867,377	0,992	12,467	9159,051	49,995
09/06/2018 02:00	155,537	257129,442	0,953	13,241	6928,953	50
09/06/2018 03:00	11,443	0	22,265	0,605	0	49,999
09/06/2018 04:00	1,321	0	45,866	0,096	0	50,003
09/06/2018 05:00	1,324	0	56,609	0,088	0	44,892
09/06/2018 06:00	0,986	0	52,221	0,037	0	49,997
09/06/2018 07:00	0,952	0	49,742	0,025	0	50,001
09/06/2018 08:00	0,975	0	58,469	0,045	0	50
09/06/2018 09:00	6,987	0	7,196	0,053	0	50,003
09/06/2018 10:00	0,925	0	56,932	0,024	0	49,97
09/06/2018 11:00	0,952	0	64,258	0,026	0	49,72
09/06/2018 12:00	0,984	0	56,867	0,03	0	49,387
09/06/2018 13:00	0,909	0	57,249	0,022	0	49,246
09/06/2018 14:00	0,828	0	40,975	0,005	0	49,108
09/06/2018 15:00	0,794	0	34,55	0	0	49,346
09/06/2018 16:00	0,876	0	47,117	0,012	0	49,631
09/06/2018 17:00	0,945	0	57,23	0,017	0	49,742
09/06/2018 18:00	0,852	0	53,423	0,007	0	49,688
09/06/2018 19:00	0,737	0	90,195	0,001	0	49,71
09/06/2018 20:00	0,74	0	228,117	0	0	49,907
09/06/2018 21:00	0,749	0	395,845	0,003	0	49,995
09/06/2018 22:00	0,727	1096,284	386,64	0	0	49,999
09/06/2018 23:00	0,729	0	418,253	0	0	49,998
10/06/2018 00:00	0,695	0	178,448	0	0	46,199
10/06/2018 01:00	0,729	0	256,745	0	0	45,103
10/06/2018 02:00	0,77	0	49,252	0	0	45,752
10/06/2018 03:00	0,791	0	41,929	0	0	45,801
10/06/2018 04:00	0,714	0	32,615	0	0	48,895
10/06/2018 05:00	0,75	0	39,289	0,004	0	49,997
10/06/2018 06:00	0,708	0	33,605	0	0	49,997
10/06/2018 07:00	0,7	0	81,795	0	0	50,001
10/06/2018 08:00	0,695	0	35,91	0	0	50,001
10/06/2018 09:00	7,934	0	3,053	0	0	50,001
10/06/2018 10:00	0,763	0	48,017	0	0	49,998
10/06/2018 11:00	1,059	0	0	0	0	49,892
10/06/2018 12:00	0,895	0	4923,021	0	0	49,572
10/06/2018 13:00	0,746	0	1492,042	0	0	49,499
10/06/2018 14:00	0,787	0	1454,135	0	58,499	49,385
10/06/2018 15:00	0,79	0	91,789	0	0	49,323
10/06/2018 16:00	0,867	0	80,667	0,001	0	49,265
10/06/2018 17:00	1,006	0	152,929	0	0	49,323
10/06/2018 18:00	0,774	0	81,955	0	0	49,36
10/06/2018 19:00	0,756	0	67,07	0,001	0	49,288
10/06/2018 20:00	0,766	0	72,456	0	105,864	49,126
10/06/2018 21:00	0,88	0	204,472	0,002	0	49,428
10/06/2018 22:00	63,925	144555,169	1,439	5,122	5769,945	49,582
10/06/2018 23:00	65,725	376529,444	1,043	9,065	9312,562	49,774
11/06/2018 00:00	91,257	380708,697	1,141	9,053	9300,515	49,864
11/06/2018 01:00	96,211	381115,282	1,109	9,072	9294,742	49,645
11/06/2018 02:00	101,855	380482,715	1,113	9,004	9294,041	49,035
11/06/2018 03:00	106,866	380123,808	1,098	9,003	9296,571	45,001
11/06/2018 04:00	110,739	380110,975	1,011	9,044	9294,026	45,001
11/06/2018 05:00	92,244	377662,153	1,032	8,97	9294,002	45,092
11/06/2018 06:00	79,092	379931,253	1,026	9,063	9315,075	49,951
11/06/2018 07:00	92,785	379814,947	1,028	9,145	9308,233	49,998
11/06/2018 08:00	99,86	380254,1	1,033	9,217	9316,495	50

11/06/2018 09:00	77,335	386171,294	0,981	9,084	9599,591	50,004
11/06/2018 10:00	54,135	389340,877	1,043	9,073	9656,448	49,717
11/06/2018 11:00	49,356	388881,019	1,008	9,114	9686,539	48,778
11/06/2018 12:00	48,779	390607,723	0,999	9,118	9680,041	48,813
11/06/2018 13:00	40,446	389612,603	1,005	9,213	9676,196	48,732
11/06/2018 14:00	37,997	389440,633	1,027	9,309	9675,738	48,708
11/06/2018 15:00	42,31	390104,289	1,056	9,231	9686,035	49,169
11/06/2018 16:00	62,154	391852,95	1,07	9,121	9693,081	48,834
11/06/2018 17:00	79,411	393408,701	1,057	9,097	9701,593	45,874
11/06/2018 18:00	59,98	395859,519	1,071	9,163	9823,388	47,712
11/06/2018 19:00	53,156	398209,864	1,061	9,273	9895,662	49,803
11/06/2018 20:00	50,718	398258,384	1,054	9,323	9899,792	49,979
11/06/2018 21:00	49,599	397801,215	1,051	9,37	9910,741	49,864
11/06/2018 22:00	47,673	397898,659	1,054	9,378	9914,373	50
11/06/2018 23:00	19,183	408469,722	1,033	10,242	10263,127	50,001
12/06/2018 00:00	37,094	401883,42	1,033	9,783	10022,283	49,996
12/06/2018 01:00	49,565	397667,287	1,056	9,462	9904,156	50
12/06/2018 02:00	49,275	397146,058	1,051	9,477	9906,672	50
12/06/2018 03:00	50,38	397403,471	1,042	9,513	9903,215	49,218
12/06/2018 04:00	47,781	397146,49	1,038	9,556	9906,118	48,087
12/06/2018 05:00	52,273	398331,884	1,034	9,553	9895,274	48,443
12/06/2018 06:00	47,847	399580,864	1,049	9,62	9916,368	48,238
12/06/2018 07:00	45,381	397343,071	1,035	9,674	9904,672	48,444
12/06/2018 08:00	43,293	398739,577	1,027	9,756	9904,789	48,715
12/06/2018 09:00	39,019	395823,826	0,969	9,881	9884,65	47,453
12/06/2018 10:00	23,456	395225,958	1,011	10,062	9878,617	46,402
12/06/2018 11:00	15,469	393889,583	0,973	10,389	9889,103	45,099
12/06/2018 12:00	6,605	392621,639	0,934	11,44	9874,528	45,163
12/06/2018 13:00		408323,136	1,007	15,362	9874,931	44,901
12/06/2018 14:00		408174,585	1,008	15,362	9874,931	44,901
12/06/2018 15:00		408174,585	1,008	15,362	9874,931	44,802
12/06/2018 16:00		408174,585	1,008	15,362	9874,931	44,858
12/06/2018 17:00	4,37	392030,66	0,93	11,936	9861,86	45,044
12/06/2018 18:00	8,262	393127,166	0,944	11,157	9874,354	45,057
12/06/2018 19:00	40,676	381389,821	0,975	10,414	9504,379	45,159
12/06/2018 20:00	53,701	380533,541	0,968	10,21	9391,553	45,479
12/06/2018 21:00	60,044	381208,076	0,97	10,055	9435,659	45,665
12/06/2018 22:00	28,895	395106,798	0,958	10,237	9850,981	45,817
12/06/2018 23:00	26,503	394255,908	0,965	10,243	9900,717	46,224
13/06/2018 00:00	31,281	393357,65	0,96	10,197	9896,449	46,299
13/06/2018 01:00	33,423	394718,727	0,961	10,147	9897,104	46,321
13/06/2018 02:00	32,555	394843,01	0,966	10,146	9891,013	46,628
13/06/2018 03:00	33,893	396708,075	0,959	10,169	9889,925	46,718
13/06/2018 04:00	31,054	395234,369	0,938	10,237	9889,062	46,902
13/06/2018 05:00	29,773	423304,255	0,939	10,228	9886,81	47,32
13/06/2018 06:00	28,419	398575,15	0,934	10,389	9938,323	47,006
13/06/2018 07:00	33,881	397794,39	0,935	10,172	9890,785	47,424
13/06/2018 08:00	173,199	325987,059	14,281	11,202	8442,783	47,72
13/06/2018 09:00	44,048	0	302,856	1,822	75,804	46,923
13/06/2018 10:00	1,401	0	418,113	0,085	0	46,027
13/06/2018 11:00	1,171	0	0	0,064	0	45,339
13/06/2018 12:00	1,192	0	24389,007	0,063	0	44,983
13/06/2018 13:00	1,252	0	18294,732	0,068	35,163	48,801
13/06/2018 14:00	36,374	197852,808	41,284	8,626	8540,839	48,61
13/06/2018 15:00	43,079	369898,896	0,991	10,675	9107,807	48,62
13/06/2018 16:00	46,616	369195,465	0,994	10,497	9123,527	48,998
13/06/2018 17:00	44,877	372134,212	0,997	10,413	9264,82	49,244
13/06/2018 18:00	27,83	380300,442	0,981	9,887	9561,152	49,659
13/06/2018 19:00	35,157	381192,716	1	9,652	9569,301	49,766
13/06/2018 20:00	38,627	381441,294	1,044	9,53	9581,843	49,865
13/06/2018 21:00	39,848	381961,299	1,044	9,507	9593,113	49,971
13/06/2018 22:00	44,615	382241,077	1,042	9,403	9607,404	49,986
13/06/2018 23:00	41,767	381212,859	1,01	9,401	9615,264	49,999
14/06/2018 00:00	38,686	381049,122	1,018	9,458	9615,617	49,997
14/06/2018 01:00	52,952	382659,935	1,071	9,295	9604,101	50
14/06/2018 02:00	51,27	382610,095	1,031	9,276	9598,984	49,998
14/06/2018 03:00	49,024	382938,118	1,033	9,311	9598,724	49,999
14/06/2018 04:00	47,645	382702,233	1,034	9,307	9614,057	50,002
14/06/2018 05:00	49,805	434089,37	1,054	9,226	9631,034	49,999
14/06/2018 06:00	52,899	383225,414	1,052	9,212	9650,938	50
14/06/2018 07:00	42,67	393003,968	1,033	10,133	9849,014	50
14/06/2018 08:00	38,904	389767,561	1,021	9,475	9744,386	49,997
14/06/2018 09:00	36,23	388539,569	0,978	9,404	9824,47	50,001
14/06/2018 10:00	26,153	387502,903	1,016	9,567	9791,179	49,335
14/06/2018 11:00	15,547	384529,41	1,016	10,101	9814,289	48,493
14/06/2018 12:00	7,781	382715,035	0,976	11,014	9798,459	48,812
14/06/2018 13:00	26,555	370175,132	0,984	10,831	9377,726	48,537
14/06/2018 14:00	30,886	366053,324	0,991	10,721	9202,852	47,8
14/06/2018 15:00	48,829	361621,86	0,99	11,215	8995,75	48,332
14/06/2018 16:00	38,184	365150,723	0,99	10,74	9107,299	48,33
14/06/2018 17:00	42,753	366968,1	0,982	10,613	9175,811	48,537
14/06/2018 18:00	41,417	371205,276	1,002	10,33	9309,295	48,76
14/06/2018 19:00	40,309	373338,359	0,999	10,093	9387,405	48,844
14/06/2018 20:00	38,758	373424,701	1,007	9,962	9391,209	49,195
14/06/2018 21:00	44,132	373738,556	1,014	9,938	9402,527	49,71
14/06/2018 22:00	45,864	374134	1,013	9,917	9408,124	49,749
14/06/2018 23:00	48,294	374211,308	1,002	9,898	9408,3	49,94
15/06/2018 00:00	43,653	374016,709	0,984	9,925	9406,313	49,928
15/06/2018 01:00	42,68	374115,957	1,009	9,903	9402,825	47,419
15/06/2018 02:00	43,105	374426,797	0,999	9,94	9405,27	47
15/06/2018 03:00	41,395	374172,118	1,003	9,957	9399,38	46,996
15/06/2018 04:00	43,301	374477,659	1,002	9,868	9394,784	47,001
15/06/2018 05:00	31,016	426033,042	0,981	10,244	9384,652	46,999
15/06/2018 06:00	7,491	368232,489	0,969	11,175	9403,994	47
15/06/2018 07:00	22,9	363128,242	0,993	11,133	9193,052	46,993
15/06/2018 08:00	61,707	356168,676	1,004	11,622	8929,823	49,057
15/06/2018 09:00	40,656	372674,204	0,924	10,375	9343,6	49,991
15/06/2018 10:00	22,428	362358,306	0,981	11,211	9153,908	49,949
15/06/2018 11:00	38,193	350645,591	1,009	11,821	8778,177	49,107
15/06/2018 12:00	33,052	351576,098	0,929	11,906	8778,039	48,439
15/06/2018 13:00	30,888	352608,808	0,927	11,96	8776,732	48,644
15/06/2018 14:00	40,887	353741,36	0,921	12,028	8776,282	47,316

15/06/2018 15:00	19,854	355959,728	0,915	11,524	8930,715	48,27
15/06/2018 16:00	25,101	358483,702	0,911	11,401	8956,736	48,561
15/06/2018 17:00	27,1	356565,896	0,918	11,479	8934,456	48,813
15/06/2018 18:00	40,082	359338,165	0,918	11,441	8952,801	48,681
15/06/2018 19:00	38,514	359007,841	0,93	11,417	8981,905	48,98
15/06/2018 20:00	49,069	358739,171	0,922	11,385	8985,264	49,381
15/06/2018 21:00	50,93	360638,377	0,927	11,29	8991,3	49,793
15/06/2018 22:00	39,735	364254,802	0,939	11,006	9103,586	49,98
15/06/2018 23:00	16,422	371744,127	0,929	10,591	9388,34	49,998
16/06/2018 00:00	143,577	198605,722	1,126	8,262	5390,884	49,996
16/06/2018 01:00	8,723	0	242,501	0,563	0	49,998
16/06/2018 02:00	1,887	0	160,218	0,188	0	49,999
16/06/2018 03:00	1,422	0	197,132	0,123	0	49,998
16/06/2018 04:00	1,303	0	158,537	0,096	0	49,995
16/06/2018 05:00	1,292	0	166,181	0,09	0	49,997
16/06/2018 06:00	1,171	0	183,448	0,072	0	49,998
16/06/2018 07:00	1,082	0	186,081	0,052	0	50
16/06/2018 08:00	1,034	0	4094,782	0,042	0	49,987
16/06/2018 09:00	5,352	0	373,396	0,041	0	49,947
16/06/2018 10:00	1,269	0	271,384	0,065	0	49,953
16/06/2018 11:00	1,296	0	7668,905	0,068	0	49,382
16/06/2018 12:00	1,354	0	13693,235	0,067	0	49,107
16/06/2018 13:00	1,256	0	12738,822	0,051	0	49,262
16/06/2018 14:00	1,188	0	6367,894	0,043	0	48,522
16/06/2018 15:00	1,099	0	259,106	0,031	0	49,05
16/06/2018 16:00	0,921	0	143,838	0,008	0	48,104
16/06/2018 17:00	0,947	0	135,941	0,01	0	44,09
16/06/2018 18:00	1,135	0	197,231	0,028	0	47,104
16/06/2018 19:00	1,109	0	184,454	0,029	0	49,322
16/06/2018 20:00	0,975	0	196,397	0,014	0	49,794
16/06/2018 21:00	0,919	0	190,394	0,008	0	47,928
16/06/2018 22:00	0,886	0	177,836	0,007	0	46,997
16/06/2018 23:00	0,76	0	124,826	0,001	0	47,002
17/06/2018 00:00	0,764	0	138,295	0	0	47
17/06/2018 01:00	0,702	0	634,935	0	0	47,006
17/06/2018 02:00	0,692	0	106,216	0	0	47,004
17/06/2018 03:00	0,692	0	116,368	0	0	47,005
17/06/2018 04:00	0,691	0	165,203	0	0	47,002
17/06/2018 05:00	0,688	0	0,066	0	0	47,005
17/06/2018 06:00		0	0	0	0	47,001
17/06/2018 07:00		0	0	0	0	46,997
17/06/2018 08:00		0	0	0	0	46,997
17/06/2018 09:00		0	0	0	0	46,997
17/06/2018 10:00	0,929	0	575,024	0,001	0	46,999
17/06/2018 11:00	1,022	0	9138,467	0,015	0	47
17/06/2018 12:00	1,105	0	0	0,024	0	46,995
17/06/2018 13:00	1,144	0	12072,878	0,026	0	46,979
17/06/2018 14:00	1,182	0	5498,77	0,023	0	46,837
17/06/2018 15:00	1,014	0	199,33	0,007	0	45,46
17/06/2018 16:00	0,899	0	114,955	0	0	47,001
17/06/2018 17:00	0,97	0	129,972	0,004	0	47,002
17/06/2018 18:00	1,012	0	149,134	0,007	0	46,998
17/06/2018 19:00	0,88	0	99,168	0,001	0	47
17/06/2018 20:00	0,85	0	96,828	0,001	0	47,002
17/06/2018 21:00	1,002	0	189,287	0,007	0	46,998
17/06/2018 22:00	1	0	126,662	0,008	0	46,998
17/06/2018 23:00	0,963	0	136,315	0,008	0	47,001
18/06/2018 00:00	0,883	0	120,06	0,003	0	47,262
18/06/2018 01:00	0,777	0	360,334	0	0	47,998
18/06/2018 02:00	0,785	0	95,615	0	0	47,998
18/06/2018 03:00	0,8	0	107,247	0	0	47,999
18/06/2018 04:00	0,789	0	90,069	0	0	47,996
18/06/2018 05:00	0,702	0	58,426	0	0	48,005
18/06/2018 06:00	0,7	0	54,94	0	0	48,05
18/06/2018 07:00	0,738	0	73,087	0	0	50
18/06/2018 08:00	0,755	0	2977,252	0	0	49,986
18/06/2018 09:00	4,378	0	335,917	0,001	0	49,989
18/06/2018 10:00	7,95	416,303	2,987	3,516	2987,584	48,861
18/06/2018 11:00	10,79	253789,488	0,68	13,057	8929,177	49,262
18/06/2018 12:00	20,613	331355,795	0,905	12,944	8385,888	48,729
18/06/2018 13:00	16,849	331487,748	0,91	13,132	8386,689	48,635
18/06/2018 14:00	15,428	331619,688	0,909	13,017	8374,615	48,375
18/06/2018 15:00	13,87	331611,918	0,905	13,008	8355,722	48,585
18/06/2018 16:00	14,971	332806,149	0,907	13,026	8352,498	48,425
18/06/2018 17:00	27,925	336475,632	0,913	12,741	8371,704	48,486
18/06/2018 18:00	53,858	338892,02	0,907	12,96	8393,674	48,896
18/06/2018 19:00	47,943	341379,41	0,933	12,902	8484,664	49,179
18/06/2018 20:00	39,389	344726,504	0,923	12,417	8597,673	49,415
18/06/2018 21:00	35,426	345246,418	0,929	12,41	8599,277	49,823
18/06/2018 22:00	48,211	345947,508	0,924	12,51	8606,116	49,921
18/06/2018 23:00	50,543	349954,822	0,925	12,378	8663,015	49,998
19/06/2018 00:00	55,812	353571,41	0,923	12,182	8797,62	49,993
19/06/2018 01:00	46,458	358434,499	0,91	11,654	8948,75	50
19/06/2018 02:00	45,395	358592,122	0,911	11,117	8999,171	49,671
19/06/2018 03:00	46,695	361992,891	0,921	10,621	9088,369	47,472
19/06/2018 04:00	44,002	365693,115	0,901	10,121	9188,802	49
19/06/2018 05:00	49,05	421669,174	0,899	10,011	9188,052	48,994
19/06/2018 06:00	53,255	367744,704	0,895	9,892	9200,878	49,287
19/06/2018 07:00	53,24	367807,023	0,904	9,85	9202,23	50
19/06/2018 08:00	45,648	367254,008	0,895	9,983	9203,019	49,995
19/06/2018 09:00	41,581	364904,87	0,833	10,247	9197,492	49,974
19/06/2018 10:00		361730,554	0,854	15,245	9147,733	49,997
19/06/2018 11:00		360156,143	0,863	15,245	9164,333	49,38
19/06/2018 12:00	15,545	359384,452	1,016	10,534	9157,621	49,02
19/06/2018 13:00	8,999	359722,923	0,962	10,708	9157,661	48,621
19/06/2018 14:00	7,326	360118,083	0,97	10,724	9155,345	48,434
19/06/2018 15:00	18,362	361326,584	0,976	10,198	9149,817	48,616
19/06/2018 16:00	23,129	362833,914	0,958	10,241	9147,151	48,759
19/06/2018 17:00	23,537	362453,196	0,974	10,158	9160,136	48,779
19/06/2018 18:00	34,406	363004,486	0,992	10,153	9170,119	49,045
19/06/2018 19:00	35,746	363383,341	1,007	10,113	9173,167	49,144
19/06/2018 20:00	41,375	363039,468	1,015	10,12	9181,384	49,439

19/06/2018 21:00	41,53	362975,822	0,996	9,979	9184,261	49,624
19/06/2018 22:00	37,642	363280,305	0,998	10,232	9187,597	49,698
19/06/2018 23:00	40,006	363894,119	0,992	10,201	9188,716	49,7
20/06/2018 00:00	40,699	363868,803	0,987	10,085	9193,899	49,695
20/06/2018 01:00	52,611	365365,068	0,999	9,973	9194,954	39,473
20/06/2018 02:00	64,083	366565,072	0,982	9,753	9201,001	38,578
20/06/2018 03:00	53,703	366290,774	0,984	9,545	9204,067	46,533
20/06/2018 04:00	51,426	366219,266	0,995	9,773	9203,005	49,001
20/06/2018 05:00	56,461	416770,228	0,992	9,674	9190,314	48,985
20/06/2018 06:00	53,508	367520,309	0,975	9,824	9215,403	49,721
20/06/2018 07:00	37,479	377458,309	0,978	9,536	9475,671	49,989
20/06/2018 08:00	26,935	380324,136	0,975	9,627	9597,615	49,993
20/06/2018 09:00	29,271	379082,335	0,912	9,779	9591,237	49,888
20/06/2018 10:00	10,098	376347,414	0,968	10,298	9560,812	49,981
20/06/2018 11:00	6,821	373924,54	0,965	10,842	9578,267	49,487
20/06/2018 12:00	21,418	367931,445	0,959	11,068	9347,338	49,362
20/06/2018 13:00		357518,946	0,955	15,17	8982,659	48,973
20/06/2018 14:00	29,197	358948,852	0,967	11,433	8977,221	49,095
20/06/2018 15:00	35,244	358565,661	0,973	11,442	8963,581	49,013
20/06/2018 16:00	39,611	359824,438	0,962	11,464	8966,72	49,03
20/06/2018 17:00	50,707	360468,28	0,97	11,293	8976,814	48,979
20/06/2018 18:00	73,827	360546,966	0,97	11,172	8986,232	49,038
20/06/2018 19:00	27,488	377976,661	0,971	10,66	9606,532	49,055
20/06/2018 20:00	23,922	378064,644	0,973	10,128	9590,857	48,98
20/06/2018 21:00	23,84	378415,892	0,985	10,058	9602,627	49,015
20/06/2018 22:00	28,874	379043,929	0,985	10,021	9603,391	49,052
20/06/2018 23:00	38,372	378783,053	0,981	9,857	9596,897	49,021
21/06/2018 00:00	34,018	378057,899	0,979	9,887	9604,22	48,79
21/06/2018 01:00	30,067	378113,873	0,977	9,974	9603,373	49,055
21/06/2018 02:00	45,403	379756,455	0,986	9,753	9598,889	49,026
21/06/2018 03:00	37,001	380136,047	0,957	9,798	9605,988	49,052
21/06/2018 04:00	40,226	380443,104	0,953	9,694	9605,607	49,037
21/06/2018 05:00	39,308	418414,123	0,956	9,673	9597,334	49,025
21/06/2018 06:00	36,451	380630,741	0,968	9,682	9618,012	49,03
21/06/2018 07:00	42,73	381553,969	0,965	9,642	9610,64	49,056
21/06/2018 08:00	46,854	382038,572	0,969	9,642	9606,531	48,988
21/06/2018 09:00	42,377	338269,904	1,023	8,524	8484,264	48,966
21/06/2018 10:00	4,124	0	145,333	0,268	0	49,056
21/06/2018 11:00	1,191	0	6652,268	0,093	78,877	49,006
21/06/2018 12:00	1,405	0	0	0,109	0	48,452
21/06/2018 13:00	1,711	0	8917,186	0,145	233,077	46,963
21/06/2018 14:00	75,364	157447,109	51,636	8,545	7966,317	48,77
21/06/2018 15:00	9,956	361948,162	0,964	10,977	9166,656	48,891
21/06/2018 16:00	8,84	361869,196	0,968	11,063	9158,641	48,721
21/06/2018 17:00	15,417	361588,503	0,981	11,038	9163,952	46,876
21/06/2018 18:00	30,769	365627,662	0,974	10,773	9168,538	48,696
21/06/2018 19:00	35,614	366549,672	0,988	10,45	9182,429	48,813
21/06/2018 20:00	39,032	366043,941	1,003	10,241	9181,501	48,977
21/06/2018 21:00	45,34	366192,672	1,023	10,19	9184,329	49,051
21/06/2018 22:00	44,714	366568,097	1,031	10,177	9187,592	49,061
21/06/2018 23:00	42,921	370149,155	1,018	10,034	9248,687	49,057
22/06/2018 00:00	32,034	373223,523	0,995	10,087	9384,635	48,9
22/06/2018 01:00	41,122	376390,871	0,988	9,788	9428,025	45,999
22/06/2018 02:00	28,401	375893,332	0,974	9,794	9591,238	46,95
22/06/2018 03:00	36,252	375394,672	0,996	9,572	9589,146	48,998
22/06/2018 04:00	34,908	375831,226	0,99	9,706	9589,832	49,004
22/06/2018 05:00	40,41	410114,56	0,973	9,436	9579,073	49,003
22/06/2018 06:00	38,391	381388,654	0,966	9,545	9598,131	49,429
22/06/2018 07:00	35,04	381627,984	0,956	9,601	9595,514	47,517
22/06/2018 08:00	40,596	382236,716	0,957	9,553	9592,765	45,998
22/06/2018 09:00	38,73	383036,378	0,894	9,725	9586,296	45,998
22/06/2018 10:00	19,569	380922,695	0,947	10,171	9538,558	46,001
22/06/2018 11:00	6,501	392544,349	0,936	13,096	10077,668	46,002
22/06/2018 12:00	2,727	395050,826	0,958	15,283	10372,142	45,993
22/06/2018 13:00	2,653	395945,842	0,902	15,451	10371,341	45,998
22/06/2018 14:00	2,589	397521,943	0,887	15,17	10358,356	46,003
22/06/2018 15:00	2,527	399852,829	0,872	15,151	10357,667	46,003
22/06/2018 16:00	2,525	400567,582	0,89	14,891	10371,942	45,997
22/06/2018 17:00	2,561	399831,092	0,886	14,54	10361,497	48,388
22/06/2018 18:00	2,601	399993,026	0,912	14,305	10358,746	48,884
22/06/2018 19:00	2,67	400236,253	0,931	14,197	10371,7	49,26
22/06/2018 20:00	2,95	400884,098	0,906	13,806	10366,742	49,751
22/06/2018 21:00	2,97	404066,022	0,924	13,78	10372,496	49,953
22/06/2018 22:00	2,99	404374,556	0,893	13,796	10376,955	49,977
22/06/2018 23:00	3,061	404178,365	0,91	13,695	10377,375	50,004
23/06/2018 00:00	3,629	405907,264	0,921	13,442	10371,379	49,999
23/06/2018 01:00	3,753	406125,854	0,916	13,381	10377,17	49,996
23/06/2018 02:00	3,611	405699,125	0,92	13,388	10372,128	50,004
23/06/2018 03:00	3,532	405564,216	0,905	13,428	10370,426	49,999
23/06/2018 04:00	3,357	405046,471	0,911	13,476	10373,014	49,998
23/06/2018 05:00	4,484	420089,868	0,906	12,869	10372,122	49,999
23/06/2018 06:00	3,721	407657,962	0,898	13,272	10378,04	50,001
23/06/2018 07:00	5,069	408475,842	0,916	12,618	10364,531	49,998
23/06/2018 08:00	4,28	407572,058	0,907	12,926	10365,606	50,004
23/06/2018 09:00	7,08	406160,534	0,861	13,31	10384,109	49,997
23/06/2018 10:00	28,835	389668,796	0,917	11,344	9843,228	49,997
23/06/2018 11:00	50,602	376472,391	0,952	9,706	9381,385	50,001
23/06/2018 12:00	46,122	375526,668	0,925	9,906	9380,057	49,982
23/06/2018 13:00	37,263	374666,576	0,935	10,041	9384,307	49,678
23/06/2018 14:00	35,606	374251,223	0,907	10,161	9395,523	49,566
23/06/2018 15:00	32,01	372206,497	0,927	10,214	9396,108	49,253
23/06/2018 16:00	33,817	372999,293	0,939	10,144	9384,659	49,212
23/06/2018 17:00	31,776	371934,78	0,918	10,276	9397,003	49,723
23/06/2018 18:00	40,233	373700,019	0,928	10,15	9405,903	49,89
23/06/2018 19:00	48,407	374935,407	0,938	9,874	9414,845	49,908
23/06/2018 20:00	41,755	378563,634	0,94	9,783	9546,751	49,967
23/06/2018 21:00	34,634	377190,441	0,937	9,784	9628,607	49,998
23/06/2018 22:00	37,512	378438,258	0,96	9,668	9627,126	49,999
23/06/2018 23:00	40,249	378488,303	0,964	9,632	9626,032	49,998
24/06/2018 00:00	39,677	379324,794	0,968	9,681	9624,638	49,999
24/06/2018 01:00	36,025	378322,552	0,959	9,618	9624,736	49,998
24/06/2018 02:00	30,945	380160,418	0,917	9,609	9629,938	50

24/06/2018 03:00	32,625	368198,311	0,936	9,915	9345,382	49,999
24/06/2018 04:00	40,479	369199,644	0,931	9,883	9272,664	49,999
24/06/2018 05:00	42,549	415791,04	0,921	9,543	9484,293	49,998
24/06/2018 06:00	46,961	378787,83	0,927	9,484	9496,283	49,998
24/06/2018 07:00	44,543	383877,739	0,93	9,345	9633,204	49,999
24/06/2018 08:00	49,505	383985,813	0,947	9,258	9638,351	50,002
24/06/2018 09:00	52,741	383585,405	0,87	9,225	9635,721	50
24/06/2018 10:00	35,665	382230,688	0,918	9,345	9617,268	49,974
24/06/2018 11:00	43,947	375956,985	0,919	9,308	9415,381	49,545
24/06/2018 12:00	38,745	374362,439	0,939	9,439	9414,998	49,237
24/06/2018 13:00	70,238	365443,102	0,902	10,057	9159,043	49,295
24/06/2018 14:00	146,146	31809,72	142,195	4,448	1794,142	49,316
24/06/2018 15:00	2,049	0	142,494	0,096	0	49,112
24/06/2018 16:00	1,17	0	139,549	0,054	0	49,541
24/06/2018 17:00	1,131	0	137,722	0,029	0	49,803
24/06/2018 18:00	1,109	0	152,15	0,019	0	49,752
24/06/2018 19:00	1,561	0	182,224	0,058	0	49,942
24/06/2018 20:00	1,215	0	207,746	0,028	0	49,999
24/06/2018 21:00	1,123	0	190,332	0,017	0	49,893
24/06/2018 22:00	1,926	0	293,28	0,098	0	49,997
24/06/2018 23:00	1,162	0	174,727	0,021	0	49,994
25/06/2018 00:00	1,224	0	203,993	0,03	0	49,761
25/06/2018 01:00	1,258	0	547,114	0,033	0	49,966
25/06/2018 02:00	1,195	0	192,132	0,025	0	49,997
25/06/2018 03:00	1,151	0	175,867	0,02	0	50,002
25/06/2018 04:00	1,146	0	192,045	0,026	0	49,986
25/06/2018 05:00	1,044	0	235,448	0,009	0	50
25/06/2018 06:00	0,894	0	143,017	0,002	0	49,987
25/06/2018 07:00	1,125	0	202,037	0,033	0	33,291
25/06/2018 08:00	1,651	0	233,134	0,095	0	31,998
25/06/2018 09:00	5,562	0	8,573	0,06	0	32,001
25/06/2018 10:00	1,484	0	364,879	0,073	0	32
25/06/2018 11:00	19,351	0	694,553	0,927	1663,365	32,001
25/06/2018 12:00	121,832	136204,718	61,818	8,91	8658,61	31,999
25/06/2018 13:00	42,334	364013,369	2,991	10,824	9158,871	32
25/06/2018 14:00	50,151	361268,197	0,945	11,148	9024,563	31,996
25/06/2018 15:00	61,024	361765,483	0,963	10,943	9021,715	32,003
25/06/2018 16:00	50,221	365822,826	0,951	10,57	9168,501	32,719
25/06/2018 17:00	44,963	365761,825	0,953	10,424	9228,934	44,235
25/06/2018 18:00	51,592	368655,764	0,959	10,317	9234,811	44,998
25/06/2018 19:00	55,708	368744,141	0,975	10,246	9240,748	44,996
25/06/2018 20:00	58,142	368204,083	0,984	10,119	9247,102	45,003
25/06/2018 21:00	63,915	362773,058	1,019	10,141	9250,535	44,995
25/06/2018 22:00	61,482	366155,651	1,011	10,262	9325,078	45,002
25/06/2018 23:00	8,028	386232,334	1,001	11,568	10048,18	47,843
26/06/2018 00:00	9,051	387703,089	0,993	11,43	10048,746	50
26/06/2018 01:00	10,622	388252,69	0,965	11,215	10050,822	50,002
26/06/2018 02:00	10,568	388076,454	0,972	11,232	10044,934	49,999
26/06/2018 03:00	10,18	388959,984	0,958	11,257	10041,506	50,001
26/06/2018 04:00	8,86	388511,975	0,933	11,348	10042,127	49,997
26/06/2018 05:00	30,831	415187,213	0,965	9,737	9650,449	50,001
26/06/2018 06:00	33,771	380597,684	0,968	9,784	9648,943	50
26/06/2018 07:00	36,866	380895,253	0,961	9,774	9639,847	50,001
26/06/2018 08:00	32,816	380376,182	0,944	9,879	9644,987	46,16
26/06/2018 09:00	26,93	380046,826	0,9	10,115	9621,366	46,734
26/06/2018 10:00	37,877	375780,701	0,971	10,083	9459,558	50,003
26/06/2018 11:00	50,907	368044,35	0,961	10,494	9224,794	49,972
26/06/2018 12:00	47,973	363603,426	0,965	11,012	9101,521	49,997
26/06/2018 13:00	47,585	364797,701	1,089	10,688	9150,872	49,976
26/06/2018 14:00	40,059	360915,709	0,936	11,098	9105,164	49,981
26/06/2018 15:00	52,613	361019,745	0,974	11,29	9025,778	49,999
26/06/2018 16:00	54,082	361227,777	0,971	11,229	9027,205	49,999
26/06/2018 17:00	26,274	369879,541	0,941	10,731	9362,2	50,003
26/06/2018 18:00	23,984	371987,066	0,956	10,49	9433,141	49,995
26/06/2018 19:00	19,407	371134,523	0,957	10,648	9434,463	49,999
26/06/2018 20:00	27,273	371087,834	0,953	10,411	9427,663	50
26/06/2018 21:00	17,818	370032,026	0,943	10,811	9430,797	49,999
26/06/2018 22:00	25,558	371098,658	0,958	10,606	9435,521	49,999
26/06/2018 23:00	24,605	371597,149	0,952	10,492	9438,741	49,998
27/06/2018 00:00	47,338	366712,816	0,97	10,479	9259,124	49,997
27/06/2018 01:00	49,695	368605,977	0,962	10,426	9272,491	50,003
27/06/2018 02:00	34,23	372664,237	0,933	10,373	9430,687	45,403
27/06/2018 03:00	30,435	372386,041	0,935	10,405	9433,785	46,076
27/06/2018 04:00	27,042	372276,297	0,93	10,492	9435,88	50
27/06/2018 05:00	37,169	419906,817	0,947	10,353	9430,05	50,001
27/06/2018 06:00	37,667	373397,862	0,965	10,308	9456,674	50
27/06/2018 07:00	42,104	373845,9	0,956	10,344	9438,355	50,001
27/06/2018 08:00	42,747	369938,246	0,951	10,48	9341,662	50,001
27/06/2018 09:00	47,581	365315,393	0,901	10,862	9225,459	50
27/06/2018 10:00	43,248	362378,032	0,965	11,243	9102,415	50
27/06/2018 11:00	32,246	359799,596	0,962	11,366	9120,673	50,005
27/06/2018 12:00	14,047	358820,57	0,951	11,543	9112,446	49,738
27/06/2018 13:00	36,065	350047,38	0,919	12,379	8801,838	49,996
27/06/2018 14:00	47,125	344749,267	0,893	12,598	8626,626	49,984
27/06/2018 15:00	50,073	345931,919	0,9	12,383	8603,555	49,903
27/06/2018 16:00	60,083	347393,911	0,893	12,105	8602,07	49,828
27/06/2018 17:00	51,249	352873,124	0,884	11,938	8771,833	49,914
27/06/2018 18:00	51,849	357466,049	0,904	11,622	8943,095	49,994
27/06/2018 19:00	21,677	364800,114	0,911	11,007	9207,669	50,002
27/06/2018 20:00	29,71	364730,023	0,894	10,976	9210,63	49,995
27/06/2018 21:00	31,887	364632,086	0,924	11,02	9216,115	50,003
27/06/2018 22:00	30,881	364428,664	0,912	10,915	9229,4	49,999
27/06/2018 23:00	28,226	364038,573	0,913	11,009	9230,237	50
28/06/2018 00:00	29,092	364311,517	0,899	10,92	9221,403	49,68
28/06/2018 01:00	30,962	364577,586	0,895	10,671	9224,776	49,969
28/06/2018 02:00	36,05	366398,277	0,898	10,708	9227,822	49,957
28/06/2018 03:00	45,107	367909,177	0,894	10,637	9221,595	49,997
28/06/2018 04:00	49,361	368149,277	0,866	10,497	9217,212	49,984
28/06/2018 05:00	39,834	421060,123	0,883	10,542	9213,4	49,983
28/06/2018 06:00	45,815	371383,827	0,888	10,312	9311,923	49,998
28/06/2018 07:00	31,405	370435,786	0,884	10,448	9339,871	49,988
28/06/2018 08:00	52,375	363814,222	0,904	10,866	9097,464	49,979

28/06/2018 09:00	60,064	362159,321	0,829	10,737	9125,04	50
28/06/2018 10:00	49,089	361566,929	0,9	10,812	9086,266	49,989
28/06/2018 11:00	53,936	361896,963	0,886	10,836	9108,058	49,998
28/06/2018 12:00	54,053	363176,118	0,883	10,891	9101,556	49,446
28/06/2018 13:00	56,553	363678,051	1,088	10,748	9088,332	49,886
28/06/2018 14:00	48,485	362444,253	0,961	10,749	9097,472	49,996
28/06/2018 15:00	46,76	363764,87	0,962	10,681	9114,395	49,984
28/06/2018 16:00	51,678	364038,75	0,959	10,567	9116,668	49,551
28/06/2018 17:00	63,494	364270,516	0,981	10,375	9120,954	49,639
28/06/2018 18:00	56,397	372145,693	1,006	10,008	9358,917	49,759
28/06/2018 19:00	50,102	374736,837	0,947	9,791	9432,468	49,801
28/06/2018 20:00	54,702	374288,862	0,96	9,728	9435,225	49,984
28/06/2018 21:00	44,862	378111,985	1,045	9,612	9562,301	49,945
28/06/2018 22:00	39,126	379694,224	0,98	9,527	9639,84	49,979
28/06/2018 23:00	36,741	379548,943	0,955	9,502	9648,071	50,002
29/06/2018 00:00	123,974	191988,283	1,036	7,726	5140,386	49,997
29/06/2018 01:00	5,414	0	269,447	0,286	0	49,999
29/06/2018 02:00	1,349	0	140,029	0,065	0	49,997
29/06/2018 03:00	1,291	0	159,881	0,044	0	49,997
29/06/2018 04:00	1,281	0	230,943	0,037	0	49,997
29/06/2018 05:00	1,252	0	752,11	0,04	0	49,996
29/06/2018 06:00	1,246	0	2431,21	0,034	0	46,255
29/06/2018 07:00	1,329	0	2050,559	0,045	0	47,957
29/06/2018 08:00	1,534	0	1155,231	0,061	0	50,003
29/06/2018 09:00	6,479	0	99,843	0,072	0	50
29/06/2018 10:00	24,463	15827,614	10,45	2,75	3425,679	49,998
29/06/2018 11:00	16,334	235151,877	18,742	9,872	9628,177	49,918
29/06/2018 12:00	6,443	377424,119	0,952	11,232	9642,254	49,658
29/06/2018 13:00	3,385	375728,907	0,939	11,894	9643,736	49,443
29/06/2018 14:00		380898,872	0,896	14,514	9897,391	49,395
29/06/2018 15:00	2,167	374188,956	0,901	12,442	9618,031	49,419
29/06/2018 16:00		375338,388	0,895	14,51	9614,797	49,494
29/06/2018 17:00		374546,77	0,887	14,51	9623,198	49,719
29/06/2018 18:00	5,082	376757,652	0,898	10,67	9631,747	49,934
29/06/2018 19:00	8,715	378001,451	0,905	10,229	9639,596	49,99
29/06/2018 20:00	11,573	378675,782	0,926	9,944	9647,551	50,001
29/06/2018 21:00	14,565	379376,219	0,912	9,737	9662,8	50,004
29/06/2018 22:00	19,207	380487,694	0,937	9,507	9669,118	50,003
29/06/2018 23:00	104,075	340134,1	0,837	9,724	9249,267	50,001
30/06/2018 00:00	326,983	134858,579	0,635	7,091	4689,809	49,998
30/06/2018 01:00	7,756	0	266,798	0,382	0	50
30/06/2018 02:00	1,097	0	305,836	0,102	0	41,104
30/06/2018 03:00	1,142	0	385,5	0,106	0	49,945
30/06/2018 04:00	0,972	0	421,432	0,088	0	50,001
30/06/2018 05:00	0,851	0	396,573	0,074	0	49,998
30/06/2018 06:00	0,547	0	433,362	0,032	0	49,999
30/06/2018 07:00	0,625	0	671,645	0,043	0	49,996
30/06/2018 08:00	0,698	0	11863,75	0,058	0	49,998
30/06/2018 09:00	5,214	0	360,425	0,079	0	50,002
30/06/2018 10:00		0	0	0	0	49,998
30/06/2018 11:00		0	0	0	0	50,007
30/06/2018 12:00		0	0	0	0	49,997
30/06/2018 13:00		0	0	0	0	49,99
30/06/2018 14:00		0	0	0	0	48,642
30/06/2018 15:00	0,482	0	1088,048	0,009	0	40,003
30/06/2018 16:00	0,478	0	600,404	0,009	0	39,998
30/06/2018 17:00	0,499	0	511,953	0,012	124,601	39,999
30/06/2018 18:00	0,589	0	698,256	0,02	0	39,997
30/06/2018 19:00	0,613	0	1304,266	0,02	0	39,998
30/06/2018 20:00	0,599	0	1260,6	0,018	0	39,998
30/06/2018 21:00	0,564	0	941,406	0,016	0	40,004
30/06/2018 22:00	0,578	0	2394,06	0,016	0	39,996
30/06/2018 23:00	0,57	0	14306,146	0,012	0	40,182
01/07/2018 00:00	0,491	0	4793,646	0,004	0	0
01/07/2018 01:00	1,123	0	1243,68	0,039	592,499	0
01/07/2018 02:00	0,668	0	459,927	0,015	0	0
01/07/2018 03:00	0,541	0	671,717	0,011	0	0
01/07/2018 04:00	0,541	0	734,44	0,009	0	0
01/07/2018 05:00	0,515	0	451,507	0,008	0	0
01/07/2018 06:00	0,487	0	624,911	0,007	0	0
01/07/2018 07:00	0,446	0	793,042	0,003	0	0
01/07/2018 08:00		0	0,166	0	0	0
01/07/2018 09:00		0	0,055	5,294	5090,235	17,28
01/07/2018 10:00	36,669	301122,09	0,769	11,157	9865,209	37
01/07/2018 11:00	29,364	389903,56	1,072	11,07	9838,349	37
01/07/2018 12:00	22,078	387544,219	1,033	11,385	9830,658	37
01/07/2018 13:00	28,855	387295,046	1,038	10,992	9829,488	36,998
01/07/2018 14:00	23,032	394355,06	0,926	12,477	10168,084	38,456
01/07/2018 15:00	27,759	382495,623	0,935	11,024	9864,932	37,005
01/07/2018 16:00	27,093	383891,575	0,924	11,236	9885,258	37,178
01/07/2018 17:00	12,435	387009,726	0,914	12,216	10055,261	37,998
01/07/2018 18:00	16,233	391778,054	0,898	11,877	10056,534	38,005
01/07/2018 19:00	21,833	391858,716	0,906	11,44	10056,095	37,996
01/07/2018 20:00	17,947	390481,97	0,896	11,879	10062,09	37,996
01/07/2018 21:00	15,465	387138,985	0,915	12,126	10060,671	38,001
01/07/2018 22:00	20,587	388967,798	0,92	11,738	10058,08	37,996
01/07/2018 23:00	18,823	388694,456	0,908	11,863	10059,28	38,005
02/07/2018 00:00	17,073	389034,269	0,903	12,043	10057,344	37,999
02/07/2018 01:00	13,32	388759,645	0,902	12,317	10050,318	38
02/07/2018 02:00	18,556	385504,027	0,898	12,248	9961,591	37,444
02/07/2018 03:00	43,018	376835,923	0,927	11,365	9644,488	36,001
02/07/2018 04:00	42,319	377420,982	0,915	11,475	9645,507	35,998
02/07/2018 05:00	27,344	376690,872	0,915	12,035	9804,822	36,831
02/07/2018 06:00	11,318	389991,946	0,904	12,705	10063,354	38,001
02/07/2018 07:00	10,377	389317,192	0,894	12,834	10064,774	38
02/07/2018 08:00	7,128	389373,594	0,888	13,375	10063,936	38
02/07/2018 09:00	9,429	390046,873	0,831	13,49	10052,395	38
02/07/2018 10:00	6,779	390943,971	0,899	13,201	10044,011	38,001
02/07/2018 11:00	3,626	389307,037	0,905	13,518	10040,26	37,996
02/07/2018 12:00	2,81	387928,445	0,897	13,572	10031,762	38,003
02/07/2018 13:00	2,459	387675,46	0,906	13,595	10041,012	38,002
02/07/2018 14:00	2,49	385599,31	0,88	13,596	10040,838	37,997

02/07/2018 15:00	2,402	386659,366	0,891	13,624	10036,696	38
02/07/2018 16:00	2,487	387060,769	0,894	13,701	10035,528	38,001
02/07/2018 17:00	2,958	386589,798	0,884	13,622	10037,707	38
02/07/2018 18:00	5,241	388389,55	0,891	13,048	10038,928	38,002
02/07/2018 19:00	7,666	389219,991	0,883	12,755	10040,025	38,001
02/07/2018 20:00	33,576	379488,447	0,914	11,238	9693,149	36,166
02/07/2018 21:00	32,698	376717,861	0,925	11,245	9636,54	35,998
02/07/2018 22:00	31,381	377262,917	0,925	11,314	9644,796	35,999
02/07/2018 23:00	30,201	378142,011	0,905	11,304	9647,771	36,002
03/07/2018 00:00	25,338	378142,628	0,916	11,664	9626,724	36
03/07/2018 01:00	26,46	378277,133	0,926	11,782	9618,596	36
03/07/2018 02:00	25,787	377840,137	0,89	12,054	9617,806	36,003
03/07/2018 03:00	16,514	376870,92	0,908	12,291	9630,569	36,003
03/07/2018 04:00	33,863	378677,278	0,917	11,6	9638,063	36,001
03/07/2018 05:00	39,351	377298,946	0,89	11,351	9636,896	36
03/07/2018 06:00	43,105	380944,203	0,905	11,29	9649,55	35,999
03/07/2018 07:00	35,854	379439,624	0,887	11,314	9641,007	36,001
03/07/2018 08:00	41,084	380300,5	0,887	11,347	9645,001	35,999
03/07/2018 09:00		379071,293	0,848	12,997	9639,422	36,001
03/07/2018 10:00		379074,105	0,833	12,997	9612,779	35,997
03/07/2018 11:00	36,26	378210,939	0,891	11,976	9631,549	36,002
03/07/2018 12:00	21,887	378987,251	0,891	12,333	9621,793	36,001
03/07/2018 13:00	13,434	377304,861	0,892	12,846	9627,253	36,001
03/07/2018 14:00	20,39	371398,593	0,879	12,934	9485,828	35,32
03/07/2018 15:00	40,357	364428,623	0,897	12,834	9225,501	34,003
03/07/2018 16:00	40,311	364743,339	0,901	12,878	9226,749	33,998
03/07/2018 17:00	42,238	364850,788	0,896	12,904	9226,482	34,001
03/07/2018 18:00	45,656	368745,688	0,909	12,682	9333,142	34,441
03/07/2018 19:00	39,161	372517,945	0,895	12,484	9430,055	35,002
03/07/2018 20:00	43,68	372883,34	0,903	12,394	9425,233	35,001
03/07/2018 21:00	47,945	371628,675	0,92	12,366	9432,878	35,003
03/07/2018 22:00	51,134	371990,502	0,928	12,428	9446,692	34,999
03/07/2018 23:00	52,986	373586,365	0,921	12,4	9443,187	35,003
04/07/2018 00:00	52,127	374095,876	0,906	12,451	9446,446	34,997
04/07/2018 01:00	44,376	373417,289	0,917	12,592	9438,421	35
04/07/2018 02:00	50,506	374108,047	0,897	12,459	9437,278	35
04/07/2018 03:00	49,153	373894,532	0,906	12,342	9438,51	34,999
04/07/2018 04:00	48,422	373102,063	0,891	12,279	9438,49	34,999
04/07/2018 05:00	54,832	372413,664	0,911	12,232	9428,614	35,003
04/07/2018 06:00	53,909	373486,142	0,919	12,298	9447,379	35,001
04/07/2018 07:00	47,881	372478,776	0,89	12,291	9444,157	34,995
04/07/2018 08:00	46,745	373585,091	0,901	12,302	9466,809	34,999
04/07/2018 09:00	42,714	370810,994	0,834	12,65	9449,601	34,999
04/07/2018 10:00	27,495	370709,536	0,893	12,932	9400,013	34,998
04/07/2018 11:00	37,571	367997,749	0,899	12,941	9343,935	34,576
04/07/2018 12:00	49,831	367892,342	0,91	12,916	9264,489	34,29
04/07/2018 13:00	23,978	371118,82	0,887	12,932	9425,074	34,996
04/07/2018 14:00	31,769	371001,339	2,222	12,724	9421,588	34,998
04/07/2018 15:00	53,31	374686,835	0,917	12,185	9499,97	35,257
04/07/2018 16:00	48,804	379165,498	0,927	11,826	9635,936	35,998
04/07/2018 17:00	51,687	379086,098	0,91	11,751	9645,106	36,001
04/07/2018 18:00	32,553	387615,894	0,898	13,23	9925,147	37,509
04/07/2018 19:00	3,357	402741,253	0,896	15,493	10445,282	39,997
04/07/2018 20:00	2,699	402375,668	0,898	15,639	10468,057	40,002
04/07/2018 21:00	3,054	403363,488	0,916	15,516	10473,329	39,999
04/07/2018 22:00	3,2	403515,082	0,903	15,644	10482,165	40,002
04/07/2018 23:00	3,288	401730,811	0,9	15,639	10477,049	40,001
05/07/2018 00:00	2,973	402804,963	0,895	15,806	10474,236	40,002
05/07/2018 01:00	2,671	401884,36	0,884	15,815	10468,083	40,002
05/07/2018 02:00	2,156	398196,36	0,889	15,925	10472,862	39,997
05/07/2018 03:00	23,722	376489,172	0,919	12,973	9775,656	36,496
05/07/2018 04:00	30,107	376508,204	0,919	12,2	9663,112	36
05/07/2018 05:00	36,605	375714,01	0,919	12,257	9701,546	36,15
05/07/2018 06:00	36,251	376883,92	0,91	12,141	9633,176	36,003
05/07/2018 07:00	35,968	377727,16	0,915	12,166	9650,15	35,998
05/07/2018 08:00	31,867	377588,614	0,915	12,269	9644,288	35,997
05/07/2018 09:00	33,785	377152,246	0,854	12,43	9617,355	35,998
05/07/2018 10:00	24,206	377246,766	0,914	12,485	9611,871	36,005
05/07/2018 11:00	24,091	372136,346	0,918	12,527	9477,995	35,415
05/07/2018 12:00		0	0,063	5,294	9449,238	17,708
05/07/2018 13:00		0	0	0	0	0
05/07/2018 14:00		0	0	0	0	0
05/07/2018 15:00		339543,988	0,881	11,352	9420,482	34,997
05/07/2018 16:00	42,998	384485,65	0,999	12,058	9807,439	36,963
05/07/2018 17:00	29,912	404596,568	1,034	14,255	10336,436	39,348
05/07/2018 18:00	44,048	385487,925	0,972	11,899	9841,132	36,998
05/07/2018 19:00	47,806	387413,974	0,95	12,04	9881,577	37,257
05/07/2018 20:00	44,693	388369,212	0,937	12,244	9939,024	37,499
05/07/2018 21:00	34,708	388876,6	0,918	12,41	9944,034	37,502
05/07/2018 22:00	30,35	388702,992	0,916	12,525	9942,829	37,498
05/07/2018 23:00	28,179	389395,691	0,909	12,512	9939,237	37,5
06/07/2018 00:00	29,35	389092,943	0,929	12,538	9936,438	37,497
06/07/2018 01:00	27,757	390502,023	0,924	12,551	9941,056	37,501
06/07/2018 02:00	27,891	388613,6	0,938	12,558	9943,596	37,498
06/07/2018 03:00	29,724	388547,008	0,933	12,394	9943,956	37,499
06/07/2018 04:00	30,272	388748,94	0,935	12,273	9945,175	37,501
06/07/2018 05:00	31,535	379208,936	0,957	12,147	9906,399	37,286
06/07/2018 06:00	28,723	386217,396	0,931	12,155	9835,716	36,998
06/07/2018 07:00	25,601	386251,087	0,904	12,315	9849,732	36,999
06/07/2018 08:00	26,554	381386,403	0,852	12,716	9731,28	36,286
06/07/2018 09:00	42,332	379160,504	0,95	12,376	9658,37	36,001
06/07/2018 10:00	49,156	379819,201	0,972	12,259	9652,341	35,999
06/07/2018 11:00	45,898	379566,705	0,99	12,212	9650,906	35,998
06/07/2018 12:00	42,208	379426,946	0,977	12,061	9638,924	35,994
06/07/2018 13:00	36,343	378984,633	0,962	12,258	9644,133	35,999
06/07/2018 14:00	34,186	378807,452	0,985	12,317	9648,903	35,998
06/07/2018 15:00	35,412	379634,877	0,985	12,19	9647,687	35,999
06/07/2018 16:00	37,029	380044,451	0,983	12,218	9645,271	36,002
06/07/2018 17:00	34,282	379944,3	0,978	12,35	9647,903	36,001
06/07/2018 18:00	32,346	378785,107	0,984	12,547	9649,481	36,003
06/07/2018 19:00	36,568	379165,775	0,985	12,435	9653,137	35,998
06/07/2018 20:00	39,26	379621,836	0,996	12,435	9657,446	36,001

06/07/2018 21:00	38,548	379271,763	1,006	12,398	9661,507	35,999
06/07/2018 22:00	39,586	379547,371	1,007	12,398	9665,557	35,998
06/07/2018 23:00	45,026	378768,095	1,012	12,372	9664,527	36,004
07/07/2018 00:00	49,385	379185,748	1,026	12,428	9665,863	36,002
07/07/2018 01:00	54,238	379985,403	1,009	12,445	9665,147	35,998
07/07/2018 02:00	35,774	386391,196	1,014	12,426	9852,469	36,991
07/07/2018 03:00	37,658	387220,995	1,019	12,406	9863,838	37,003
07/07/2018 04:00	39,299	387612,908	1,012	12,498	9864,906	37,001
07/07/2018 05:00	41,565	383014,308	1,009	12,481	9863,339	36,999
07/07/2018 06:00	41,64	388091,451	0,999	12,57	9860,691	36,998
07/07/2018 07:00	39,32	388122,66	0,992	12,68	9858,621	37,002
07/07/2018 08:00		387647,747	0,929	12,782	9858,236	36,999
07/07/2018 09:00		386407,123	0,988	12,698	9860,516	37
07/07/2018 10:00	27,436	386278,312	0,937	12,135	9848,606	37,002
07/07/2018 11:00	16,834	383941,393	0,924	12,724	9844,82	36,997
07/07/2018 12:00	34,247	371805,461	0,91	12,432	9465,743	35,182
07/07/2018 13:00	26,726	370951,085	0,926	12,465	9441,843	34,999
07/07/2018 14:00	20,876	369288,407	0,93	12,609	9416,751	34,797
07/07/2018 15:00	32,433	365895,051	0,937	12,617	9231,243	34,002
07/07/2018 16:00	32,39	366303,25	0,928	12,557	9230,366	34,002
07/07/2018 17:00	38,792	365477,724	0,931	12,651	9236,614	34,003
07/07/2018 18:00	44,306	368575,549	0,927	12,429	9311,833	34,39
07/07/2018 19:00	42,999	373318,45	0,923	12,315	9449,882	35,002
07/07/2018 20:00	46,629	373305,85	0,943	12,235	9453,281	34,998
07/07/2018 21:00	39,475	377933,125	0,937	12,03	9573,026	35,666
07/07/2018 22:00	31,987	380094,178	0,94	11,928	9651,763	35,998
07/07/2018 23:00	32,98	379715,06	0,922	11,892	9655,651	36,001
08/07/2018 00:00	38,36	380226,288	0,934	11,83	9655,764	36
08/07/2018 01:00	37,271	380058,626	0,94	11,75	9656,112	36
08/07/2018 02:00	35,113	384888,843	0,944	11,893	9760,414	36,606
08/07/2018 03:00	29,146	386615,859	0,934	11,842	9853,973	37,001
08/07/2018 04:00	29,421	386723,577	0,94	11,884	9858,257	36,999
08/07/2018 05:00	25,511	383158,734	0,921	12,041	9862,495	37
08/07/2018 06:00	33,864	387733,635	0,945	11,914	9857,554	37
08/07/2018 07:00	29,886	387665,278	0,919	11,956	9864,805	36,998
08/07/2018 08:00	27,468	386313,425	0,876	12,089	9866,431	37
08/07/2018 09:00	18,786	386242,595	0,94	12,621	9858,311	36,998
08/07/2018 10:00	21,514	377548,201	0,909	12,925	9621,805	35,89
08/07/2018 11:00	28,169	366353,763	0,902	12,729	9350,807	34,5
08/07/2018 12:00	28,897	361701,206	0,943	12,878	9233,043	34,002
08/07/2018 13:00	17,307	361334,384	0,901	12,975	9236,33	33,998
08/07/2018 14:00	24,848	356496,301	0,93	13,713	9027,816	33,053
08/07/2018 15:00	17,328	355765,924	0,931	14,004	9018,711	32,999
08/07/2018 16:00	14,073	356648,386	0,936	14,184	9012,271	32,998
08/07/2018 17:00	27,306	357456,247	0,932	13,831	9026,393	33,003
08/07/2018 18:00	44,586	359723,975	0,929	13,566	9070,896	33,155
08/07/2018 19:00	33,281	363905,233	0,929	12,986	9260,672	33,999
08/07/2018 20:00	38,186	364328,913	0,926	12,931	9265,827	33,999
08/07/2018 21:00	39,431	369389,348	0,935	12,736	9378,995	34,659
08/07/2018 22:00	31,495	369309,299	0,934	12,738	9432,823	34,739
08/07/2018 23:00	33,011	371611,569	0,94	12,731	9457,605	35,001
09/07/2018 00:00	14,999	380263,03	0,93	13,478	9758,553	36,467
09/07/2018 01:00	9,299	383775,199	0,924	13,531	9862,555	37,002
09/07/2018 02:00	11,864	383847,476	0,919	13,32	9865,571	36,999
09/07/2018 03:00	3,153	381313,702	0,906	14,662	9875,703	36,994
09/07/2018 04:00	2,244	379729,28	0,898	15,007	9873,684	37
09/07/2018 05:00	5,687	381168,532	0,919	14,06	9860,533	36,998
09/07/2018 06:00	8,778	382805,941	0,909	13,607	9844,64	36,996
09/07/2018 07:00	3,701	377502,412	0,899	14,75	9779,835	36,564
09/07/2018 08:00	36,536	361611,344	0,867	14,562	9163,888	33,498
09/07/2018 09:00	72,119	361251,845	0,942	13,823	9076,556	33,045
09/07/2018 10:00	26,962	362535,259	0,906	13,354	9243,598	33,969
09/07/2018 11:00	13,598	359754,819	0,882	13,605	9235,544	34,005
09/07/2018 12:00	22,661	347892,07	0,909	15,039	8893,516	32,272
09/07/2018 13:00	27,057	339682,324	0,912	15,231	8670,353	30,95
09/07/2018 14:00	21,191	339917,321	0,913	15,03	8660,546	31
09/07/2018 15:00	25,724	339321,06	0,917	15,181	8617,109	30,751
09/07/2018 16:00	46,339	337431,906	0,918	15,699	8454,324	30,107
09/07/2018 17:00	38,714	346892,292	0,908	14,498	8715,366	31,399
09/07/2018 18:00	29,251	355963,615	0,902	13,782	9038,459	32,986
09/07/2018 19:00	20,337	361878,514	0,91	12,846	9267,204	34
09/07/2018 20:00	27,704	362473,454	0,917	12,848	9265,056	33,998
09/07/2018 21:00	34,763	364438,002	0,924	12,73	9320,302	34,288
09/07/2018 22:00	33,944	370000,841	0,925	12,389	9479,084	34,996
09/07/2018 23:00	27,897	374366,583	0,917	12,607	9583,8	35,538
10/07/2018 00:00	12,66	382628,916	0,894	12,972	9903,641	37,003
10/07/2018 01:00	12,692	382826,846	0,887	13,078	9904,299	36,999
10/07/2018 02:00	9,483	382069,24	0,881	13,504	9905,612	36,996
10/07/2018 03:00	16,043	382859,416	0,888	12,869	9901,027	36,998
10/07/2018 04:00	30,78	384997,822	0,886	12,087	9893,612	36,998
10/07/2018 05:00	50,329	377581,249	0,887	11,91	10005,245	37,755
10/07/2018 06:00	39,116	402653,528	0,875	11,958	10302,767	39,001
10/07/2018 07:00	33,575	402221,969	0,844	11,855	10284,472	39,001
10/07/2018 08:00	33,512	401952,281	0,817	11,878	10295,383	39,002
10/07/2018 09:00	29,977	401447,129	0,853	11,84	10265,573	38,999
10/07/2018 10:00	30,133	401281,216	0,919	11,914	10230,034	39,002
10/07/2018 11:00	29,315	401072,197	0,962	11,93	10268,15	39
10/07/2018 12:00	24,752	400091,292	0,972	12,325	10269,15	39
10/07/2018 13:00	20,764	399623,146	0,972	12,676	10273,052	39
10/07/2018 14:00	19,159	399378,738	0,974	12,8	10280,411	39,004
10/07/2018 15:00	18,664	398323,963	0,987	12,86	10286,614	38,999
10/07/2018 16:00	19,214	398769,539	0,995	12,822	10273,549	39,004
10/07/2018 17:00	19,593	398813,53	1,014	12,736	10280,89	39
10/07/2018 18:00	19,756	398801,179	0,957	12,762	10293,141	39
10/07/2018 19:00	20,159	398958,879	0,971	12,72	10294,411	39,004
10/07/2018 20:00	21,644	399027,454	0,979	12,586	10290,395	38,996
10/07/2018 21:00	20,361	399163,851	0,957	12,749	10303,219	38,999
10/07/2018 22:00	18,996	398808,379	0,972	12,897	10304,969	39
10/07/2018 23:00	21,061	399535,72	0,983	12,651	10304,133	39
11/07/2018 00:00	35,293	394428,244	0,988	11,713	10130,785	38,108
11/07/2018 01:00	34,776	393853,035	0,957	11,636	10094,506	38
11/07/2018 02:00	33,996	393901,729	0,981	11,686	10097,378	37,998

11/07/2018 03:00	35,838	394248,437	0,984	11,68	10094,735	37,998
11/07/2018 04:00	38,237	394510,701	0,995	11,662	10090,689	38,004
11/07/2018 05:00	40,516	386792,185	1,002	11,616	10086,926	38
11/07/2018 06:00	44,222	395622,161	0,991	11,685	10099,798	38,004
11/07/2018 07:00	40,612	395339,012	0,969	11,677	10102,89	38,001
11/07/2018 08:00	41,74	394832,115	0,928	11,754	10096,903	38,004
11/07/2018 09:00	42,025	392055,833	0,989	11,715	9995,744	37,622
11/07/2018 10:00	43,226	391835,406	0,964	11,687	9964,921	37,499
11/07/2018 11:00	41,746	391592,739	0,927	11,776	9971,68	37,499
11/07/2018 12:00	38,889	382232,027	0,936	11,819	9806,815	36,61
11/07/2018 13:00	24,874	380367,909	0,971	12,203	9775,638	36,456
11/07/2018 14:00	22,739	376963,369	0,961	12,322	9668,297	36
11/07/2018 15:00	14,511	374616,488	0,977	12,68	9652,259	35,996
11/07/2018 16:00	35,601	369255,443	0,973	12,574	9423,277	34,934
11/07/2018 17:00	52,695	364410,228	0,976	12,32	9427,726	34,962
11/07/2018 18:00	43,618	373936,664	1,004	12,087	9666,844	36,002
11/07/2018 19:00	40,159	379839,531	0,975	12,037	9807,574	36,713
11/07/2018 20:00	40,011	382284,691	0,98	11,898	9884,282	37,002
11/07/2018 21:00	41,019	382543,843	0,975	11,841	9889,136	37,001
11/07/2018 22:00	41,387	383765,25	0,993	11,829	9898,881	36,999
11/07/2018 23:00	47,617	381244,26	0,995	11,887	9901,478	37,001
12/07/2018 00:00	43,331	384028,13	0,97	11,925	9917,769	36,999
12/07/2018 01:00	41,57	384059,609	0,98	11,805	9915,691	36,999
12/07/2018 02:00	48,095	384292,51	0,97	11,771	9903,738	37
12/07/2018 03:00	47,134	385674,023	0,96	11,734	9901,639	36,997
12/07/2018 04:00	56,205	386928,08	0,964	11,881	9900,324	36,998
12/07/2018 05:00	43,616	387982,499	0,953	11,957	9996,664	37,566
12/07/2018 06:00	30,216	393940,656	0,947	12,016	10120,74	38
12/07/2018 07:00	34,732	393482,724	0,957	12,134	10087,283	37,922
12/07/2018 08:00	40,301	389539,182	0,87	11,947	10009,732	37,46
12/07/2018 09:00	27,416	385919,233	0,934	12,287	9884,401	37
12/07/2018 10:00	22,893	385110,912	0,938	12,404	9859,036	36,906
12/07/2018 11:00	34,599	369772,175	0,922	12,61	9478,698	35,002
12/07/2018 12:00		368531,877	0,954	12,878	0	35,002
12/07/2018 13:00	7,585	367893,745	0,946	13,539	9476,375	35,002
12/07/2018 14:00	5,382	367934,829	0,913	13,944	9469,987	35,002
12/07/2018 15:00	5,345	365699,914	0,826	13,867	9458,548	35,001
12/07/2018 16:00	6,509	365962,626	0,854	13,635	9465,912	35
12/07/2018 17:00	14,52	366598,517	0,84	12,981	9476,716	35,002
12/07/2018 18:00	22,977	368609,243	0,85	12,877	9477,362	35
12/07/2018 19:00	25,757	368860,362	0,88	12,828	9482,934	35,002
12/07/2018 20:00	31,716	369481,927	0,855	12,854	9487,131	34,998
12/07/2018 21:00	27,186	369663,292	0,873	13,077	9493,2	35,001
12/07/2018 22:00	27,39	370077,634	0,873	13,036	9494,915	34,998
12/07/2018 23:00	30,059	369761,089	0,881	12,965	9495,741	35
13/07/2018 00:00	28,071	369694,215	0,874	13,232	9499,078	34,998
13/07/2018 01:00	31,578	370651,965	0,862	13,026	9504,051	34,999
13/07/2018 02:00	21,149	369612,336	0,866	13,487	9503,698	35,005
13/07/2018 03:00	18,605	369856,859	0,861	13,577	9500,398	34,936
13/07/2018 04:00	38,334	364682,886	0,862	13,623	9303,874	34
13/07/2018 05:00	37,334	355681,491	0,876	13,788	9283,42	34,003
13/07/2018 06:00	34,597	363110,101	0,867	13,926	9304,56	34,001
13/07/2018 07:00	27,351	362700,673	0,865	13,972	9298,762	34,002
13/07/2018 08:00	4,116	382640,754	0,852	16,199	10002,143	37,642
13/07/2018 09:00	4,695	384226,464	0,81	16,575	10078,873	37,999
13/07/2018 10:00	2,046	382646,402	0,853	17,243	10051,201	37,996
13/07/2018 11:00	2,208	377285,083	0,881	18,912	10030,1	37,732
13/07/2018 12:00	2,277	380412,892	0,867	21,979	10045,888	38
13/07/2018 13:00	2,258	380737,001	0,86	22,232	10048,114	38,001
13/07/2018 14:00	2,333	382294,844	0,866	22,14	10042,173	37,998
13/07/2018 15:00	2,247	382343,58	0,866	22,208	10035,302	38,004
13/07/2018 16:00	2,308	383581,664	0,852	22,13	10034,12	38
13/07/2018 17:00	2,579	385274,62	0,862	21,515	10041,197	38
13/07/2018 18:00	3,272	383360,57	0,868	19,341	10065,292	38,003
13/07/2018 19:00	2,151	382104,801	0,85	17,029	10090,23	37,997
13/07/2018 20:00	2,096	382789,191	0,868	16,72	10094,997	38,001
13/07/2018 21:00	2,254	384409,426	0,867	16,113	10097,96	37,998
13/07/2018 22:00	2,128	384814,536	0,859	15,909	10099,675	37,999
13/07/2018 23:00	2,141	363378,464	0,863	15,531	10099,996	37,999
14/07/2018 00:00	19,478	0	0	2,841	1213,946	1,763
14/07/2018 01:00		0	0	0	0	0
14/07/2018 02:00		0	0	0	0	0
14/07/2018 03:00		0	0	0	0	0
14/07/2018 04:00		0	0	0	0	0
14/07/2018 05:00		0	0	0	0	0
14/07/2018 06:00		0	0	0	0	0
14/07/2018 07:00		0	0	0	0	0
14/07/2018 08:00		0	0	0	0	0
14/07/2018 09:00		0	0	0	0	0
14/07/2018 10:00		0	0	0	0	0
14/07/2018 11:00		0	0	0	0	0
14/07/2018 12:00		0	0	0	0	0
14/07/2018 13:00		0	0	0	0	0
14/07/2018 14:00		0	0	0	0	0
14/07/2018 15:00		0	0	0	0	0
14/07/2018 16:00		0	0	0	0	0
14/07/2018 17:00		0	0	0	0	0
14/07/2018 18:00		0	0	0	0	0
14/07/2018 19:00		0	0	0	0	0
14/07/2018 20:00		0	0	0	0	0
14/07/2018 21:00		0	0	0	0	0
14/07/2018 22:00		0	0	0	0	0
14/07/2018 23:00		0	0	0	0	0
15/07/2018 00:00		0	0	0	0	0
15/07/2018 01:00		0	0	0	0	0
15/07/2018 02:00		0	0	0	0	0
15/07/2018 03:00		0	0	0	0	0
15/07/2018 04:00		0	0	0	0	0
15/07/2018 05:00		0	0	0	0	0
15/07/2018 06:00		0	0	0	0	0
15/07/2018 07:00		0	0	0	0	0
15/07/2018 08:00		0	0	0	0	0

15/07/2018 09:00		0	0	0	0	0	0
15/07/2018 10:00		0	0	0	0	0	0
15/07/2018 11:00		0	0	0	0	0	0
15/07/2018 12:00		0	0	0	0	0	0
15/07/2018 13:00		0	0	0	0	0	0
15/07/2018 14:00		0	0	0	0	0	0
15/07/2018 15:00		0	0	0	0	0	0
15/07/2018 16:00		0	0	0	0	0	0
15/07/2018 17:00		0	0	0	0	0	0
15/07/2018 18:00		0	0	0	0	0	0
15/07/2018 19:00		0	0	0	0	0	0
15/07/2018 20:00		0	0	0	0	0	0
15/07/2018 21:00		0	0	0	0	0	0
15/07/2018 22:00		0	0	0	0	0	0
15/07/2018 23:00		0	0	0	0	0	0
16/07/2018 00:00		0	0	0	0	0	0
16/07/2018 01:00		0	0	0	0	0	0
16/07/2018 02:00		0	0	0	0	0	0
16/07/2018 03:00		0	0	0	0	0	0
16/07/2018 04:00		0	0	0	0	0	0
16/07/2018 05:00		0	0	0	0	0	0
16/07/2018 06:00		0	0	0	0	0	0
16/07/2018 07:00		0	0	0	0	0	0
16/07/2018 08:00		0	0	0	0	0	0
16/07/2018 09:00		0	0	0	0	0	0
16/07/2018 10:00		0	0	0	0	0	0
16/07/2018 11:00		0	0	0	0	0	0
16/07/2018 12:00		0	0	0	0	0	0
16/07/2018 13:00		0	0	0	0	0	0
16/07/2018 14:00		0	0	0	0	0	0
16/07/2018 15:00		0	0	0	0	0	0
16/07/2018 16:00		0	0	0	0	0	0
16/07/2018 17:00		0	0	0	0	0	0
16/07/2018 18:00		0	0	0	0	0	0
16/07/2018 19:00		0	0	0	0	0	0
16/07/2018 20:00		0	0,45	5,6	4412,491	10,096	
16/07/2018 21:00	384,092	211788,96	0,379	13,826	7856,97	26,244	
16/07/2018 22:00	43,653	377631,193	0,99	12,498	9381,485	35,003	
16/07/2018 23:00	37,326	381682,335	0,999	12,482	9504,336	35,717	
17/07/2018 00:00	35,161	383628,287	1,009	12,33	9573	35,997	
17/07/2018 01:00	35,761	383719,639	0,999	12,344	9569,866	36,001	
17/07/2018 02:00	37,831	383653,768	1,006	12,328	9568,008	36,002	
17/07/2018 03:00	42,279	384330,838	0,997	12,4	9524,797	35,999	
17/07/2018 04:00	37,816	384016,949	0,994	12,506	9503,258	36,002	
17/07/2018 05:00	38,642	381566,858	1,001	12,467	9499,87	35,995	
17/07/2018 06:00	42,811	384097,71	0,988	12,56	9492,915	36,005	
17/07/2018 07:00	41,043	384284,109	1,001	12,619	9489,85	36	
17/07/2018 08:00	41,001	385177,039	1,001	12,577	9499,35	36,149	
17/07/2018 09:00	12,838	394017,158	0,915	13,856	9854,474	37,908	
17/07/2018 10:00	8,808	394457,976	0,932	13,894	9870,2	38,002	
17/07/2018 11:00	10,499	394794,38	0,887	13,609	9903,325	38,001	
17/07/2018 12:00	25,057	389528,709	0,884	12,56	9736,903	37,043	
17/07/2018 13:00	21,542	388980,825	0,883	12,626	9742,342	37,002	
17/07/2018 14:00	19,541	389016,715	0,886	12,611	9740,469	37,002	
17/07/2018 15:00	21,869	388986,186	0,902	12,561	9731,984	36,999	
17/07/2018 16:00	27,229	389249,538	0,908	12,448	9737,207	36,998	
17/07/2018 17:00	36,632	389993,114	0,918	12,493	9747,017	36,998	
17/07/2018 18:00	39,975	382805,94	0,944	12,528	9751,217	37,001	
17/07/2018 19:00	40,664	383946,151	0,937	12,624	9752,174	36,998	
17/07/2018 20:00	43,011	384940,535	0,943	12,614	9761,73	36,998	
17/07/2018 21:00	45,349	388496,847	0,922	12,548	9770,045	37,001	
17/07/2018 22:00	41,242	388279,603	0,899	12,477	9775,978	36,999	
17/07/2018 23:00	43,827	387670,472	0,931	12,52	9770,569	37	
18/07/2018 00:00	37,311	392419,63	0,92	12,66	9907,02	37,741	
18/07/2018 01:00	15,138	404142,088	0,896	14,369	10301,496	39,696	
18/07/2018 02:00	11,786	406659,537	0,885	14,527	10356,695	39,999	
18/07/2018 03:00	10,662	407472,989	0,885	14,703	10356,437	39,999	
18/07/2018 04:00	11,812	408221,893	0,888	14,403	10359,215	39,997	
18/07/2018 05:00	14,101	376649,659	0,893	14,118	10351,622	39,998	
18/07/2018 06:00	15,365	410075,841	0,881	14,005	10380,909	40,002	
18/07/2018 07:00	19,295	410521,277	0,875	13,616	10392,951	39,998	
18/07/2018 08:00	17,357	410681,535	0,888	13,71	10353,209	40	
18/07/2018 09:00	13,524	407035,596	0,834	14,287	10332,183	40	
18/07/2018 10:00	15,64	407411,35	0,713	17,517	10335,236	39,996	
18/07/2018 11:00	8,149	406558,711	0,934	14,604	10348,307	39,995	
18/07/2018 12:00	7,771	408432,273	0,912	14,773	10355,58	40,001	
18/07/2018 13:00	4,46	407889,021	0,889	15,608	10344,404	40	
18/07/2018 14:00	4,554	407578,66	0,923	15,38	10347,442	40	
18/07/2018 15:00	21,008	396766,121	0,922	12,83	9986,544	38,153	
18/07/2018 16:00	16,574	396414,389	0,914	12,993	9940,049	37,999	
18/07/2018 17:00	16,571	395785,364	0,927	13,024	9936,307	38	
18/07/2018 18:00	23,669	394877,643	0,942	12,677	9945,047	38,001	
18/07/2018 19:00	30,325	395403,954	0,936	12,604	9953,316	38	
18/07/2018 20:00	36,541	396528,742	0,916	12,604	9963,519	38,001	
18/07/2018 21:00	41,769	397125,231	0,936	12,458	9973,027	37,999	
18/07/2018 22:00	31,655	402566,709	0,955	12,979	10162,558	38,868	
18/07/2018 23:00	16,772	408965,728	0,947	13,52	10381,306	40,003	
19/07/2018 00:00	21,028	409785,001	0,964	13,048	10384,897	39,999	
19/07/2018 01:00	21,883	409690,788	0,95	13,072	10367,72	39,998	
19/07/2018 02:00	35,287	404088,063	0,959	12,543	10180,436	39,038	
19/07/2018 03:00	39,404	404472,418	0,958	12,499	10159,965	39	
19/07/2018 04:00	40,448	404361,586	0,975	12,546	10157,286	39,002	
19/07/2018 05:00	44,197	383265,65	0,961	12,492	10155,366	39,001	
19/07/2018 06:00	44,857	405566,018	0,974	12,524	10183,075	38,999	
19/07/2018 07:00	44,751	405709,641	0,97	12,565	10158,985	39,002	
19/07/2018 08:00	49	405658,134	0,952	12,553	10160,606	39	
19/07/2018 09:00	38,951	404465,17	0,9	12,615	10117,568	38,998	
19/07/2018 10:00	24,338	403855,877	1,017	12,784	10140,817	38,999	
19/07/2018 11:00	38,121	389208,504	0,903	12,637	9930,129	37,908	
19/07/2018 12:00	43,949	389806,672	0,905	12,384	9744,33	37,001	
19/07/2018 13:00	37,998	388695,212	0,91	12,498	9737,923	36,998	
19/07/2018 14:00	32,318	389037,928	0,926	12,749	9732,714	37,001	

19/07/2018 15:00	28,891	387853,958	0,939	12,86	9730,033	36,998
19/07/2018 16:00	29,098	388259,376	0,944	12,843	9729,244	36,997
19/07/2018 17:00	31,798	387792,846	0,949	12,837	9746,431	36,997
19/07/2018 18:00	45,1	390637,883	0,947	12,701	9748,331	37,003
19/07/2018 19:00	49,377	393020,921	0,952	12,593	9799,67	37,196
19/07/2018 20:00	40,886	398470,896	0,953	12,764	9976,953	38,004
19/07/2018 21:00	44,905	398691,64	0,95	12,701	9972,079	37,997
19/07/2018 22:00	38,926	404758,851	0,967	12,853	10133,856	38,828
19/07/2018 23:00	37,833	405053,081	0,958	12,924	10179,1	39,003
20/07/2018 00:00	36,481	404989,68	0,955	12,921	10185,134	38,998
20/07/2018 01:00	40,714	405735,526	0,958	12,969	10183,034	39,001
20/07/2018 02:00	37,266	404230,289	0,957	13,029	10184,632	38,999
20/07/2018 03:00	31,721	403971,707	0,947	13,211	10179,978	38,999
20/07/2018 04:00	36,682	404931,913	0,939	13,068	10181,924	38,999
20/07/2018 05:00	39,541	382182,448	0,951	12,869	10181,752	39,001
20/07/2018 06:00	45,31	407671,591	0,951	13,039	10256,147	39,284
20/07/2018 07:00	29,249	409641,32	0,926	13,121	10351,971	39,743
20/07/2018 08:00	32,56	404168,206	0,935	13,041	10195,116	38,999
20/07/2018 09:00	19,365	401202,274	0,867	13,351	10142,563	38,999
20/07/2018 10:00	35,608	389065,074	0,933	12,981	9813,078	37,091
20/07/2018 11:00	26,497	386365,688	0,887	13,162	9761,759	37
20/07/2018 12:00	27,712	379404,788	0,869	13,346	9579,885	36,055
20/07/2018 13:00	28,599	376455,851	0,888	13,6	9456,427	35,43
20/07/2018 14:00	28,443	374114,174	0,884	13,813	9343,23	35,001
20/07/2018 15:00	23,075	373132,48	0,898	14,008	9326,497	34,996
20/07/2018 16:00	19,458	373334,462	0,909	14,017	9318,691	35,001
20/07/2018 17:00	22,008	372588,027	0,892	13,843	9324,737	35,001
20/07/2018 18:00	33,724	374397,655	0,893	13,782	9342,644	35
20/07/2018 19:00	33,209	374282,901	0,901	13,683	9361,172	34,998
20/07/2018 20:00	27,677	373823,076	0,902	13,873	9358,351	35,003
20/07/2018 21:00	14,341	371684,267	0,899	14,381	9359,003	35
20/07/2018 22:00	19,629	372752,75	0,889	14,103	9380,963	34,999
20/07/2018 23:00	29,718	369772,314	0,904	13,837	9380,293	35,002
21/07/2018 00:00	28,416	371492,407	0,915	13,686	9376,96	35,004
21/07/2018 01:00	32,314	372242,769	0,918	13,546	9362,492	35,002
21/07/2018 02:00	40,52	371030,557	0,92	13,378	9361,378	34,998
21/07/2018 03:00	41,779	372722,009	0,921	13,275	9365,077	35,005
21/07/2018 04:00	34,864	372094,006	0,914	13,416	9361,889	34,999
21/07/2018 05:00	23,398	371113,804	0,913	13,665	9363,112	34,998
21/07/2018 06:00	39,184	375583,069	0,889	13,56	9355,836	34,999
21/07/2018 07:00	29,547	381604,14	0,883	13,07	9520,379	35,944
21/07/2018 08:00	29,494	380838,379	0,891	13,172	9543,601	35,998
21/07/2018 09:00	29,603	380798,535	0,822	13,016	9541,376	36,002
21/07/2018 10:00	18,614	379529,402	1,002	13,299	9538,272	35,999
21/07/2018 11:00	11,107	378814,53	0,839	13,651	9533,334	36,004
21/07/2018 12:00	5,617	374865,933	0,86	14,136	9528,134	36,001
21/07/2018 13:00	7,058	373393,758	0,851	14,184	9464,559	35,642
21/07/2018 14:00	26,651	363119,621	0,854	14,508	9126,252	33,819
21/07/2018 15:00	47,554	359691,16	0,859	14,517	8949,641	33,003
21/07/2018 16:00	44,649	364536,094	0,844	13,846	9091,239	33,781
21/07/2018 17:00	56,053	366798,544	0,834	13,428	9152,225	34,001
21/07/2018 18:00	63,569	371639,49	0,839	13,248	9283,322	34,595
21/07/2018 19:00	36,068	380450,781	0,835	12,749	9552,256	36
21/07/2018 20:00	44,912	381575,214	0,855	12,548	9561,118	36
21/07/2018 21:00	35,282	385360,34	0,839	12,582	9724,522	36,842
21/07/2018 22:00	35,528	387051,632	0,839	12,595	9771,024	36,999
21/07/2018 23:00	36,107	384673,673	0,841	12,481	9770,813	36,998
22/07/2018 00:00	39,223	386305,009	0,872	12,44	9768,34	36,999
22/07/2018 01:00	50,049	387402,939	0,872	12,317	9771,046	37
22/07/2018 02:00	42,51	388774,81	0,862	12,411	9841,797	37,377
22/07/2018 03:00	35,603	394243,734	0,863	12,547	9975,636	38,001
22/07/2018 04:00	42,709	395128,764	0,857	12,459	9973,895	37,999
22/07/2018 05:00	52,138	397428,679	0,837	12,425	9975,981	38,003
22/07/2018 06:00	47,503	400411,37	0,855	12,605	10025,731	38,299
22/07/2018 07:00	31,001	404112,733	0,834	12,768	10176,659	39,001
22/07/2018 08:00	39,888	404132,76	0,84	12,748	10175,602	38,999
22/07/2018 09:00	35,051	402428,992	0,772	12,776	10175,373	38,998
22/07/2018 10:00	20,207	400169,925	0,998	13,337	10109,366	38,692
22/07/2018 11:00	42,576	384756,485	0,951	12,59	9660,612	36,499
22/07/2018 12:00	34,364	383034,056	0,943	12,571	9665,703	36,5
22/07/2018 13:00	11,473	397103,113	0,922	15,386	10169,655	38,953
22/07/2018 14:00	2,022	402514,916	0,928	16,704	10368,302	40,002
22/07/2018 15:00	1,913	400590,871	0,93	16,724	10362,844	40,002
22/07/2018 16:00	5,338	392090,493	0,936	15,122	10063,254	38,506
22/07/2018 17:00	17,744	384818,305	0,963	12,956	9763,076	36,995
22/07/2018 18:00	36,473	387815,97	0,959	12,435	9775,475	36,996
22/07/2018 19:00	42,826	388694,492	0,949	12,35	9795,358	36,999
22/07/2018 20:00	46,656	389202,201	0,976	12,268	9804,825	37,001
22/07/2018 21:00	50,363	384277,183	1,002	12,21	9810,517	36,998
22/07/2018 22:00	50,084	385285,819	1,016	12,264	9825,852	36,998
22/07/2018 23:00	55,607	387088,392	1,008	12,166	9825,865	37,001
23/07/2018 00:00	50,078	394846,044	0,977	12,219	9963,287	37,752
23/07/2018 01:00	40,246	396287,083	0,944	12,195	10030,426	37,999
23/07/2018 02:00	46,075	393258,074	0,96	12,076	10029,189	38,001
23/07/2018 03:00	47,225	393878,117	0,982	12,002	10031,949	38
23/07/2018 04:00	48,727	396690,675	0,985	12,11	10080,594	38,33
23/07/2018 05:00	38,577	400137,379	0,977	12,282	10223,352	38,995
23/07/2018 06:00	40,42	404322,723	0,97	12,307	10208,256	39,001
23/07/2018 07:00	36,143	404342,331	0,953	12,269	10198,657	38,998
23/07/2018 08:00	35,462	402921,32	0,94	12,435	10208,44	38,997
23/07/2018 09:00	25,221	402877,334	0,869	12,642	10241,416	39
23/07/2018 10:00	9,361	400581,95	0,922	14,325	10231,138	39
23/07/2018 11:00	9,448	394054,099	0,883	15,229	10094,9	38,324
23/07/2018 12:00	31,205	371630,387	0,903	12,932	9408,52	34,998
23/07/2018 13:00	8,733	400932,825	0,904	17,284	10445,265	39,955
23/07/2018 14:00	14,211	391501,381	0,909	12,674	9978,814	37,998
23/07/2018 15:00	11,124	391078,039	0,909	12,959	9961,871	38
23/07/2018 16:00	9,282	392069,105	0,903	13,119	9951,21	38
23/07/2018 17:00	25,534	387259,494	0,913	11,938	9749,028	37,037
23/07/2018 18:00	47,96	380839,445	0,916	11,123	9558,087	36,001
23/07/2018 19:00	37,217	388031,998	0,919	11,764	9807,777	37,165
23/07/2018 20:00	38,863	387257,248	0,934	11,357	9782,458	37,001

23/07/2018 21:00	33,51	386054,225	0,94	11,51	9795,442	36,999
23/07/2018 22:00	14,491	383269,499	0,932	13,051	9817,847	36,999
23/07/2018 23:00	15,146	383556,777	0,936	12,789	9819,572	36,998
24/07/2018 00:00	16,668	386446,005	0,936	12,684	9812,507	36,998
24/07/2018 01:00	2,723	403629,95	0,914	16,435	10413,495	40,001
24/07/2018 02:00	2,492	403082,89	0,891	16,614	10428,729	40,001
24/07/2018 03:00	2,567	403089,33	0,902	16,454	10427,745	39,997
24/07/2018 04:00	2,641	404762,039	0,9	16,448	10428,032	40,003
24/07/2018 05:00	2,645	404258,959	0,895	16,417	10426,015	39,999
24/07/2018 06:00	14,002	395341,637	0,91	14,281	10084,311	38,282
24/07/2018 07:00	22,157	387905,619	0,925	12,48	9842,402	36,996
24/07/2018 08:00	23,61	387922,093	0,912	12,508	9794,753	37,002
24/07/2018 09:00	19,451	385856,002	0,862	12,52	9819,436	36,999
24/07/2018 10:00	12,658	385246,975	0,936	13,066	9757,563	36,997
24/07/2018 11:00	15,579	383260,632	0,858	13,959	9833,901	37,015
24/07/2018 12:00	5,026	383007,01	0,827	13,922	9789,276	36,998
24/07/2018 13:00	2,93	382500,72	0,848	14,553	9796,611	36,996
24/07/2018 14:00	2,356	382569,858	0,862	14,647	9783,928	37,001
24/07/2018 15:00	2,349	381806,444	0,851	14,683	9769,178	37
24/07/2018 16:00	2,715	383713,858	0,853	14,443	9767,612	37
24/07/2018 17:00	4,209	384282,235	0,847	13,981	9778,044	36,997
24/07/2018 18:00	11,13	384625,383	0,852	12,887	9790,55	37
24/07/2018 19:00	15,251	385198,701	0,868	12,55	9800,761	36,996
24/07/2018 20:00	16,833	386051,993	0,898	12,468	9803,892	37,004
24/07/2018 21:00	18,589	386905,895	0,895	12,449	9812,874	37,001
24/07/2018 22:00	16,102	386912,483	0,89	12,636	9827,867	36,998
24/07/2018 23:00	22,445	385520,74	0,902	12,348	9826,152	36,998
25/07/2018 00:00	4,543	402312,953	0,893	15,726	10384,335	39,8
25/07/2018 01:00	3,054	404330,906	0,876	15,849	10426,001	39,998
25/07/2018 02:00	3,422	405076,469	0,865	15,523	10426,103	40
25/07/2018 03:00	3,08	404726,002	0,857	15,566	10431,447	40,003
25/07/2018 04:00	2,497	404552,663	0,852	15,741	10433,013	40,003
25/07/2018 05:00	2,416	404034,763	0,859	15,816	10427,623	40,003
25/07/2018 06:00	3,438	406735,845	0,853	15,433	10448,852	40,002
25/07/2018 07:00	3,195	405656,649	0,865	15,569	10424,435	39,998
25/07/2018 08:00	2,227	403587,983	0,852	16,329	10437,381	40,002
25/07/2018 09:00	2	397467,862	0,794	17,873	10347,454	39,656
25/07/2018 10:00	2,006	385813,938	0,854	18,472	10076,943	38,267
25/07/2018 11:00	2,02	377069,972	0,852	18,236	9904,921	37,42
25/07/2018 12:00	2,212	382538,94	0,856	19,908	10038,181	38,125
25/07/2018 13:00	2,414	399911,245	0,846	23,09	10446,387	40,343
25/07/2018 14:00	2,173	409016,1	0,84	23,076	10765,445	41,999
25/07/2018 15:00	2,136	409557,182	0,842	22,857	10762,964	42,003
25/07/2018 16:00	2,059	411194,337	0,836	23,133	10749,247	41,998
25/07/2018 17:00	2,103	412401,246	0,839	23,638	10770,913	42,001
25/07/2018 18:00	1,994	412732,274	0,844	18,386	10786,5	41,998
25/07/2018 19:00	2,047	413942,328	0,844	17,054	10789,044	42,003
25/07/2018 20:00	2,032	413642,381	0,85	17,026	10801,003	42,004
25/07/2018 21:00	2,125	413775,465	0,843	17,173	10811,418	41,992
25/07/2018 22:00	2,147	414369,537	0,84	16,896	10813,979	42
25/07/2018 23:00	2,296	410846,179	0,837	17,136	10788,638	41,811
26/07/2018 00:00	2,061	414786,686	0,844	16,914	10799,314	41,997
26/07/2018 01:00	2,079	415524,24	0,843	16,672	10797,97	41,999
26/07/2018 02:00	2,265	415053,765	0,85	16,537	10799,855	41,999
26/07/2018 03:00	2,141	412784,717	0,837	17,93	10817,211	41,998
26/07/2018 04:00	2,149	414051,696	0,834	17,518	10813,583	41,994
26/07/2018 05:00	2,263	413971,136	0,835	17,456	10805,817	41,998
26/07/2018 06:00	2,278	417079,82	0,839	17,173	10836,358	42,004
26/07/2018 07:00	2,185	417157,452	0,816	17,148	10812,03	42
26/07/2018 08:00	2,174	415490,261	0,803	17,583	10817,888	42,002
26/07/2018 09:00	2,277	415014,762	0,767	18,082	10790,633	42
26/07/2018 10:00	2,237	409690,408	0,832	18,345	10701,372	41,494
26/07/2018 11:00	2,193	400343,536	0,904	17,676	10493,168	40,441
26/07/2018 12:00	2,296	395139,179	0,815	17,386	10384,755	39,911
26/07/2018 13:00	2,203	389928,378	0,819	17,466	10232,955	39,122
26/07/2018 14:00	2,2	388733,274	0,82	17,254	10151,69	38,911
26/07/2018 15:00	2,108	411297,298	0,81	16,108	10745,18	41,927
26/07/2018 16:00	2,042	412640,441	0,797	16,611	10769,708	42,003
26/07/2018 17:00	2,176	405543,37	0,8	15,83	10563,766	40,783
26/07/2018 18:00	28,559	378277,52	0,843	12,069	9609,103	35,989
26/07/2018 19:00	16,197	392483,27	0,834	14,128	10051,037	38,291
26/07/2018 20:00	1,994	415736,155	0,817	16,554	10796,157	41,925
26/07/2018 21:00	2,145	418481,062	0,823	15,852	10804,208	41,995
26/07/2018 22:00	2,323	418886,383	0,816	15,727	10804,658	42,001
26/07/2018 23:00	2,431	418614,42	0,816	15,606	10805,002	42
27/07/2018 00:00	2,385	419972,858	0,803	15,594	10807,344	42
27/07/2018 01:00	2,538	420242,481	0,804	15,544	10809,458	42
27/07/2018 02:00	2,531	419414,756	0,813	15,5	10805,148	42,002
27/07/2018 03:00	2,515	419342,747	0,803	15,535	10803,795	41,998
27/07/2018 04:00	2,52	419625,603	0,813	15,517	10804,1	42,001
27/07/2018 05:00	2,644	419349,64	0,817	15,48	10797,244	42
27/07/2018 06:00	2,754	420939,885	0,839	15,32	10825,365	42,001
27/07/2018 07:00	2,775	421520,003	0,873	15,306	10805,845	42,001
27/07/2018 08:00	3,063	421585,17	0,887	15,237	10820,97	42
27/07/2018 09:00	3,334	413749,104	0,819	15,115	10796,995	42,001
27/07/2018 10:00	3,269	414258,853	0,869	15,088	10800,791	41,999
27/07/2018 11:00	3,07	414137,636	0,906	15,19	10818,003	42,004
27/07/2018 12:00	2,807	419729,19	0,898	15,314	10817,99	42,002
27/07/2018 13:00	2,698	419108,084	0,915	15,475	10834,752	41,998
27/07/2018 14:00	2,567	419477,295	0,907	15,553	10836,432	41,998
27/07/2018 15:00	2,506	416748,924	0,918	15,576	10836,632	42,002
27/07/2018 16:00	2,338	416789,554	0,951	15,459	10842,235	42
27/07/2018 17:00	2,359	416587,899	0,94	15,492	10848,143	42,003
27/07/2018 18:00	2,342	415423,198	0,953	15,588	10850,747	42,002
27/07/2018 19:00	2,436	416157,311	0,936	15,473	10858,638	42,001
27/07/2018 20:00	2,36	416345,855	0,937	15,6	10863,724	42,004
27/07/2018 21:00	2,564	415950,224	0,958	15,608	10863,482	41,996
27/07/2018 22:00	2,494	416810,625	0,948	15,645	10866,788	42
27/07/2018 23:00	24,536	401546,028	0,963	12,991	10365,021	39,43
28/07/2018 00:00	40,244	395236,316	0,99	11,343	10060,793	38,003
28/07/2018 01:00	43,366	396169,272	0,991	11,345	10063,677	37,999
28/07/2018 02:00	47,707	395982,455	0,967	11,281	10067,203	37,998

28/07/2018 03:00	48,434	396439,095	0,989	11,31	10065,168	38,002
28/07/2018 04:00	42,088	396800,557	0,963	11,406	10064,743	38
28/07/2018 05:00	39,251	396579,579	0,972	11,488	10063,409	38,002
28/07/2018 06:00	44,485	397545,02	0,982	11,43	10062,406	37,999
28/07/2018 07:00	48,781	397497,595	0,977	11,288	10061,068	38,002
28/07/2018 08:00	49,951	397553,588	0,976	11,253	10058,004	37,998
28/07/2018 09:00	37,979	396249,253	0,893	11,311	10071,403	37,999
28/07/2018 10:00	25,757	394754,377	0,952	11,784	10071,255	38,002
28/07/2018 11:00	15,147	392759,487	0,971	12,78	10069,204	37,998
28/07/2018 12:00	7,149	390360,269	0,881	13,825	10063,614	38,001
28/07/2018 13:00	3,841	389985,894	0,888	14,372	10061,8	38
28/07/2018 14:00	2,881	392421,29	0,88	14,71	10117,114	38,42
28/07/2018 15:00	2,147	395767,326	0,881	15,087	10236,164	38,998
28/07/2018 16:00	2,263	391609,68	0,89	14,725	10112,486	38,356
28/07/2018 17:00	2,664	388932,799	0,914	14,424	10030,53	37,998
28/07/2018 18:00	4,307	389665,56	0,91	14,242	10041,837	37,996
28/07/2018 19:00	6,818	390472,559	0,905	13,7	10040,244	38,001
28/07/2018 20:00	35,348	381081,218	0,922	11,684	9698,697	36,173
28/07/2018 21:00	44,704	380247,431	0,93	11,347	9646,809	35,999
28/07/2018 22:00	53,92	382122,441	0,944	11,294	9652,335	35,998
28/07/2018 23:00	42,907	384787,011	0,927	11,279	9747,015	36,505
29/07/2018 00:00	45,192	387052,71	0,925	11,243	9750,147	36,5
29/07/2018 01:00	46,85	386781,037	0,928	11,226	9755,612	36,496
29/07/2018 02:00	49,47	386433,388	0,914	11,346	9749,398	36,503
29/07/2018 03:00	51,41	387340,01	0,951	11,235	9745,957	36,501
29/07/2018 04:00	49,969	389258,247	0,902	11,181	9792,442	36,776
29/07/2018 05:00	31,603	392581,764	0,91	11,358	9945,631	37,502
29/07/2018 06:00	38,237	393018,589	0,933	11,3	9944,977	37,501
29/07/2018 07:00	44,508	393781,131	0,932	11,267	9953,879	37,502
29/07/2018 08:00	44,483	393070,323	0,915	11,222	9944,429	37,5
29/07/2018 09:00	37,002	392349,059	0,859	11,403	9938,125	37,5
29/07/2018 10:00	33,003	392564,533	0,915	11,569	9921,56	37,498
29/07/2018 11:00	24,041	391081,503	0,89	11,743	9925,819	37,502
29/07/2018 12:00	18,543	390927,628	0,887	12,152	9930,161	37,54
29/07/2018 13:00	8,718	393061,034	0,865	13,464	10018,351	38,002
29/07/2018 14:00	5,941	393630,748	0,871	13,968	10013,234	38,004
29/07/2018 15:00	3,992	390524,481	0,883	14,497	10003,961	38,002
29/07/2018 16:00	3,244	390298,469	0,882	14,729	10005,689	37,996
29/07/2018 17:00	5,143	390859,731	0,887	14,166	10010,99	38,002
29/07/2018 18:00	9,068	391792,723	0,87	13,482	10030,699	38,002
29/07/2018 19:00	13,933	392938,675	0,91	12,792	10063,624	38,002
29/07/2018 20:00	18,711	393110,59	0,921	12,331	10040,682	38,001
29/07/2018 21:00	20,987	393796,093	0,924	12,13	10051,569	38
29/07/2018 22:00	20,319	393410,271	0,934	12,169	10066,583	38,001
29/07/2018 23:00	31,273	393517,194	0,937	11,894	10038,24	37,905
30/07/2018 00:00	33,769	391060,746	0,947	11,719	9953,142	37,495
30/07/2018 01:00	42,773	392730,398	0,943	11,631	9960,302	37,502
30/07/2018 02:00	51,351	393743,102	0,936	11,457	9963,829	37,495
30/07/2018 03:00	50,08	394314,136	0,927	11,271	9969,047	37,499
30/07/2018 04:00	54,687	395181,019	0,922	11,228	9971,677	37,499
30/07/2018 05:00	54,199	395047,582	0,918	11,259	9960,885	37,499
30/07/2018 06:00	53,707	394845,647	0,905	11,205	9990,791	37,498
30/07/2018 07:00	48,079	397782,16	0,92	11,353	10062,202	38,001
30/07/2018 08:00	44,565	397302,697	0,894	11,369	10069,263	38,002
30/07/2018 09:00	32,619	395542,143	0,833	11,561	10030,688	38,001
30/07/2018 10:00	21,185	393897,705	0,887	12,105	10035,795	37,999
30/07/2018 11:00	9,622	390663,814	0,961	13,451	10042,392	38,002
30/07/2018 12:00	4,128	388258,295	0,926	14,424	10042,781	37,999
30/07/2018 13:00	2,425	387226,029	0,901	14,706	10043,821	38
30/07/2018 14:00	2,085	385728,256	0,922	15,325	10034,461	37,998
30/07/2018 15:00	2,026	385540,64	0,922	15,537	10019,805	38
30/07/2018 16:00	1,99	386358,274	0,911	15,661	10014,436	38,002
30/07/2018 17:00	2,13	386829,465	0,919	15,041	10021,808	37,998
30/07/2018 18:00	2,606	388117,7	0,924	14,801	10033,479	37,996
30/07/2018 19:00	4,702	390395,908	0,942	14,37	10039,374	38
30/07/2018 20:00	11,785	389186,108	0,966	13,391	9993,185	37,703
30/07/2018 21:00	19,191	383446,207	0,984	12,351	9850,246	36,997
30/07/2018 22:00	15,686	383189,71	0,975	12,672	9874,143	37,001
30/07/2018 23:00	23,186	385292,098	0,982	12,194	9873,073	37,002
31/07/2018 00:00	30,787	380662,847	0,949	11,828	9724,518	36,2
31/07/2018 01:00	38,376	380484,028	0,95	11,5	9667,268	35,999
31/07/2018 02:00	46,45	382254,61	0,958	11,428	9664,56	36,006
31/07/2018 03:00	47,882	382689,858	0,965	11,271	9664,325	35,999
31/07/2018 04:00	49,884	382955,993	0,948	11,291	9663,204	36,003
31/07/2018 05:00	47,517	382865,898	0,947	11,291	9657,504	36
31/07/2018 06:00	45,153	381763,777	0,964	11,286	9685,127	35,999
31/07/2018 07:00	16,05	405834,931	0,925	14,927	10520,026	40,218
31/07/2018 08:00	2,194	416372,233	0,917	16,721	10875,2	41,999
31/07/2018 09:00	2,243	415125,139	0,842	17,263	10862,775	42,002
31/07/2018 10:00	2,139	413623,376	0,909	17,979	10838,038	42,002
31/07/2018 11:00	2,187	409205,464	0,9	18,039	10799,03	41,737
31/07/2018 12:00	2,135	409784,065	0,857	17,135	10759,063	41,723
31/07/2018 13:00	2,413	405966,986	0,852	15,636	10596,123	40,822
31/07/2018 14:00	2,552	401636,144	0,861	14,665	10391,732	39,999
31/07/2018 15:00	58,447	402125,416	0,654	15,974	10376,768	39,999
31/07/2018 16:00	11,34	403003,239	0,821	14,833	10371,347	40,001
31/07/2018 17:00	2,75	402661,834	0,858	14,968	10388,607	39,998
31/07/2018 18:00	3,084	402603,58	0,847	15,037	10410,433	39,997
31/07/2018 19:00	4,172	402778,559	0,873	14,848	10419,592	39,992
31/07/2018 20:00	5,391	403413,428	0,898	14,73	10426,103	40,001
31/07/2018 21:00	2,453	401953,592	0,908	16,112	10446,563	39,999
31/07/2018 22:00	2,414	403461,87	0,905	16,061	10462,87	40
31/07/2018 23:00	3,092	403353,111	0,89	15,879	10461,12	39,996
01/08/2018 00:00	3,11	403588,717	0,879	15,771	10467,587	40,001
01/08/2018 01:00	3,507	404762,112	0,878	15,353	10470,821	40,006
01/08/2018 02:00	4,175	404296,465	0,89	15,258	10463,907	39,998
01/08/2018 03:00	4,711	405096,194	0,892	14,928	10466,754	40
01/08/2018 04:00	5,643	405233,34	0,896	14,721	10465,281	40,001
01/08/2018 05:00	6,36	408382,933	0,897	14,566	10461,395	40,001
01/08/2018 06:00	7,468	407723,264	0,882	14,284	10484,958	40,002
01/08/2018 07:00	6,644	407005,006	0,898	14,494	10466,17	39,998
01/08/2018 08:00	6,76	406952,845	0,882	14,482	10461,741	40,001

01/08/2018 09:00	3,813	402328,615	0,83	15,231	10442,233	40,002
01/08/2018 10:00	3,471	402231,228	0,898	15,487	10419,616	40,001
01/08/2018 11:00	2,693	400519,565	0,889	15,741	10433,866	40,002
01/08/2018 12:00	2,247	401743,707	0,891	16,412	10434,331	39,998
01/08/2018 13:00	2,154	401117,79	0,885	16,78	10427,981	40,001
01/08/2018 14:00	2,148	400375,104	0,894	17,176	10419,21	40,001
01/08/2018 15:00	2,077	398562,156	0,898	17,338	10412,026	39,998
01/08/2018 16:00	2,127	398359,272	0,891	17,006	10410,628	40,002
01/08/2018 17:00	2,134	398990,162	0,894	16,46	10421,913	39,999
01/08/2018 18:00	2,256	399803,408	0,893	15,925	10429,571	40,002
01/08/2018 19:00	2,476	401812,454	0,905	15,552	10431,747	39,997
01/08/2018 20:00	33,459	380879,941	0,938	11,972	9710,224	36,32
01/08/2018 21:00	29,458	385280,884	0,947	12,623	9863,945	37,185
01/08/2018 22:00	3,219	402925,32	0,939	15,84	10452,741	39,999
01/08/2018 23:00	4,024	403501,601	0,927	15,416	10454,755	40,004
02/08/2018 00:00	4,327	403809,647	0,924	15,197	10453,345	39,999
02/08/2018 01:00	6,274	404860,949	0,926	14,675	10448,442	39,996
02/08/2018 02:00	8,739	405663,734	0,923	14,217	10446,589	39,999
02/08/2018 03:00	8,195	406324,318	0,919	14,305	10447,795	40,001
02/08/2018 04:00	7,434	406152,326	0,916	14,328	10453,61	40,001
02/08/2018 05:00	10,271	396416,72	0,914	13,778	10443,835	39,996
02/08/2018 06:00	13,272	408039,645	0,921	13,383	10423,009	40,001
02/08/2018 07:00	17,913	409224,021	0,918	12,711	10444,86	40,001
02/08/2018 08:00	28,313	410648,455	0,908	11,788	10450,982	40,004
02/08/2018 09:00	7,817	421436,125	0,851	14,251	10810,943	41,895
02/08/2018 10:00	4,716	420894,158	0,908	14,749	10846,983	42,002
02/08/2018 11:00	3,9	420755,781	0,923	14,955	10838,843	41,999
02/08/2018 12:00	3,172	419172,642	0,919	15,358	10833,9	42,002
02/08/2018 13:00	41,795	411813,632	0,936	15,415	10548,402	40,62
02/08/2018 14:00	2,995	420213,654	0,951	16,171	10995,832	42,569
02/08/2018 15:00	2,795	418102,456	0,949	15,549	10842,007	42,002
02/08/2018 16:00	2,896	418751,777	0,955	15,48	10849,51	41,999
02/08/2018 17:00	3,087	418936,123	0,95	15,353	10847,842	42,001
02/08/2018 18:00	3,043	420221,206	0,922	15,432	10842,591	41,997
02/08/2018 19:00	2,98	419413,045	0,933	15,561	10848,652	41,999
02/08/2018 20:00	2,83	419222,033	0,934	15,65	10849,291	42,001
02/08/2018 21:00	2,688	418891,527	0,955	15,651	10857,904	42,004
02/08/2018 22:00	2,917	418968,081	0,96	15,52	10865,565	42,001
02/08/2018 23:00	2,499	210094,649	1,3	8,033	5156,887	19,06
03/08/2018 00:00		0	0	0,162	0	0
03/08/2018 01:00		0	0	0,082	0	0
03/08/2018 02:00		0	0	0,06	0	0
03/08/2018 03:00		0	0	0,053	0	0
03/08/2018 04:00		0	0	0,047	0	0
03/08/2018 05:00		0	0	0,049	0	0
03/08/2018 06:00		0	0	0,032	0	0
03/08/2018 07:00		0	0	0,034	0	0
03/08/2018 08:00		0	0	0,04	0	0
03/08/2018 09:00		0	0	0,047	0	0
03/08/2018 10:00		0	0	0,041	0	0
03/08/2018 11:00	9,13	208042,708	38,445	13,396	9657,288	35,541
03/08/2018 12:00	2,132	423387,541	0,912	18,318	11113,7	43,282
03/08/2018 13:00	2,09	427295,23	0,884	18,103	11216,15	43,912
03/08/2018 14:00	25,054	419949,96	0,93	17,55	11747,066	46,583
03/08/2018 15:00	222,383	351049,026	1,003	14,78	8840,585	31,623
03/08/2018 16:00	19,679	398474,327	0,934	14,591	10203,194	38,966
03/08/2018 17:00	66,638	393341,681	0,95	14,99	9977,844	38,038
03/08/2018 18:00	4,37	404657,601	0,912	14,55	10412,115	40,002
03/08/2018 19:00	5,353	405945,191	0,929	14,318	10429,804	40,001
03/08/2018 20:00	2,318	403440,307	0,942	15,699	10456,992	40,001
03/08/2018 21:00	2,727	404740,493	0,956	15,741	10461,438	40,003
03/08/2018 22:00	3,111	405573,107	0,947	15,637	10460,874	40,002
03/08/2018 23:00	2,868	403734,317	0,93	15,519	10472,526	39,999
04/08/2018 00:00	3,261	403327,43	0,942	15,412	10472,779	39,999
04/08/2018 01:00	4,548	404645,188	0,952	15,047	10472,202	39,997
04/08/2018 02:00	4,226	403780,387	0,946	14,916	10474,79	40
04/08/2018 03:00	4,579	404536,967	0,945	14,639	10485,147	40,001
04/08/2018 04:00	3,704	404733,029	0,964	14,831	10472,249	39,998
04/08/2018 05:00	5,662	387590,51	0,954	14,553	10464,812	40
04/08/2018 06:00	7,609	408585,308	0,942	14,233	10460,067	40,003
04/08/2018 07:00	7,05	408484,102	0,942	14,347	10460,835	40,001
04/08/2018 08:00	2,998	405577,298	0,939	15,657	10469,089	39,997
04/08/2018 09:00	2,676	402847,316	0,884	15,786	10456,548	40
04/08/2018 10:00	2,311	400642,205	1,009	16,658	10453,761	40
04/08/2018 11:00	2,246	398306,693	0,856	17,211	10444,773	40,003
04/08/2018 12:00	2,242	395577,297	0,845	17,719	10418,102	39,932
04/08/2018 13:00	2,224	392265,077	0,848	17,857	10323,525	39,448
04/08/2018 14:00	2,155	389739,767	0,865	17,87	10200,644	38,966
04/08/2018 15:00	3,66	382009,23	0,869	14,98	9898,831	37,285
04/08/2018 16:00	26,497	363545,103	0,88	12,85	9258,804	33,906
04/08/2018 17:00	43,925	373391,02	0,888	13,75	9451,921	35,176
04/08/2018 18:00	29,768	383545,028	0,892	10,904	9815,942	37,001
04/08/2018 19:00	35,842	385421,171	0,906	10,809	9831,436	36,997
04/08/2018 20:00	17,982	383771,83	0,91	12,363	9848,28	37,002
04/08/2018 21:00	12,713	384859,006	0,901	12,789	9858,216	36,999
04/08/2018 22:00	12,046	384797,813	0,898	12,977	9863,32	36,995
04/08/2018 23:00	9,489	384709,248	0,874	13,246	9857,215	37,002
05/08/2018 00:00	5,554	384164,67	0,881	13,774	9826,477	36,999
05/08/2018 01:00	7,951	384431,655	0,9	13,378	9839,516	37,002
05/08/2018 02:00	14,789	386081,96	0,902	12,668	9828,806	37
05/08/2018 03:00	13,415	385979,011	0,881	12,79	9829,312	36,997
05/08/2018 04:00	11,748	385913,722	0,874	12,926	9828,133	37
05/08/2018 05:00	12,223	388269,809	0,885	12,857	9819,913	36,998
05/08/2018 06:00	13,395	386793,157	0,888	12,514	9806,117	37
05/08/2018 07:00	17,273	387563,281	0,902	12,348	9793,772	37
05/08/2018 08:00	16,321	386856,501	0,87	12,517	9782,572	37
05/08/2018 09:00	11,474	381134,723	0,83	12,946	9663,176	36,531
05/08/2018 10:00	8,108	375877,366	0,881	13,186	9535,406	35,877
05/08/2018 11:00	8,515	367739,013	0,859	13,238	9285,877	34,677
05/08/2018 12:00	16,473	365679,595	0,845	13,035	9134,913	34,002
05/08/2018 13:00	19,014	365443,298	0,844	12,934	9140,114	33,997
05/08/2018 14:00	18,105	365728,6	0,847	13,131	9138,371	34,001

05/08/2018 15:00	14,87	364884,727	0,836	13,358	9129,226	34,001
05/08/2018 16:00	11,538	364119,057	0,868	13,321	9116,292	33,996
05/08/2018 17:00	18,071	364723,589	0,853	13,138	9113,264	33,998
05/08/2018 18:00	19,682	364494,621	0,856	13,413	9072,49	34
05/08/2018 19:00	20,866	364620,795	0,868	13,327	9072,608	33,998
05/08/2018 20:00	27,061	365480,315	0,888	13,189	9067,573	34,001
05/08/2018 21:00	32,938	366159,589	0,874	13,166	9066,104	33,997
05/08/2018 22:00	22,752	365384,681	0,88	13,332	9074,603	34
05/08/2018 23:00	21,769	365069,437	0,892	13,375	9060,82	33,997
06/08/2018 00:00	40,109	367232,674	0,892	13,07	9051,037	34,003
06/08/2018 01:00	25,245	365559,505	0,894	13,278	9055,287	34
06/08/2018 02:00	29,675	365860,431	0,875	13,111	9062,905	34,003
06/08/2018 03:00	23,52	364331,774	0,886	13,265	9069,015	33,998
06/08/2018 04:00	32,926	365174,681	0,888	12,872	9084,744	34,001
06/08/2018 05:00	43,759	357444,767	0,884	12,643	9101,946	34,001
06/08/2018 06:00	42,948	370891,501	0,864	12,551	9144,68	34,401
06/08/2018 07:00	25,141	373423,697	0,844	12,662	9291,639	34,999
06/08/2018 08:00	2,941	401330,747	0,844	17,072	10309,938	39,976
06/08/2018 09:00	2,535	401492,556	0,793	17,133	10309,683	40,001
06/08/2018 10:00	2,328	399847,844	0,844	17,68	10303,334	39,999
06/08/2018 11:00	2,499	399723,328	0,828	17,78	10314,466	39,999
06/08/2018 12:00	2,408	398495,841	0,837	17,878	10310,797	40,002
06/08/2018 13:00	2,566	398799,941	0,819	17,98	10310,694	40,002
06/08/2018 14:00	2,55	398658,184	0,82	17,863	10295,478	39,999
06/08/2018 15:00	2,552	398522,302	0,819	17,831	10306,112	40
06/08/2018 16:00	2,606	398157,042	0,829	17,65	10311,932	40,002
06/08/2018 17:00	2,728	399007,886	0,827	17,599	10293,246	39,999
06/08/2018 18:00	5,062	381407,827	0,852	14,014	9671,785	36,912
06/08/2018 19:00	8,647	377531,916	0,858	12,71	9502,536	35,998
06/08/2018 20:00	13,494	379019,96	0,858	12,288	9504,396	35,999
06/08/2018 21:00	27,655	379875,891	0,866	11,467	9505,438	35,998
06/08/2018 22:00	33,122	380683,284	0,845	11,279	9513,782	36,001
06/08/2018 23:00	30,962	380521,536	0,859	11,277	9516,108	36
07/08/2018 00:00	29,1	381872,711	0,852	11,321	9518,671	35,998
07/08/2018 01:00	18,37	380290,137	0,849	11,881	9517,318	35,999
07/08/2018 02:00	16,402	380475,656	0,849	11,959	9515,847	35,999
07/08/2018 03:00	31,609	381693,73	0,867	11,225	9516,678	35,999
07/08/2018 04:00	46,704	383646,402	0,945	11,02	9520,097	36,002
07/08/2018 05:00	47,808	382964,548	0,928	11,012	9585,781	36,434
07/08/2018 06:00	43,789	392377,313	0,848	11,133	9776,653	37,277
07/08/2018 07:00	19,617	404072,24	0,85	12,529	10199,251	39,259
07/08/2018 08:00	7,97	407988,748	0,876	13,583	10316,468	40,002
07/08/2018 09:00	5,4	405864,611	0,805	14,317	10279,767	40,001
07/08/2018 10:00	2,854	405245,789	0,828	15,325	10309,186	39,999
07/08/2018 11:00	2,484	403570,657	0,882	15,478	10311,21	40,001
07/08/2018 12:00	2,347	399566,366	0,906	15,617	10298,572	40,001
07/08/2018 13:00	2,11	400758,454	0,899	15,836	10294,741	40
07/08/2018 14:00	2,07	400702,903	0,895	16,152	10297,296	40
07/08/2018 15:00	1,976	402815,396	0,903	16,493	10285,126	39,999
07/08/2018 16:00	1,969	402936,568	0,896	16,489	10277,592	39,997
07/08/2018 17:00	2,017	402517,508	0,886	16,568	10287,621	40,001
07/08/2018 18:00	2,165	402074,18	0,905	16,25	10300,515	39,999
07/08/2018 19:00	1,974	401697,135	0,9	16,664	10309,682	40,004
07/08/2018 20:00	1,949	401751,571	0,898	17,217	10311,477	39,999
07/08/2018 21:00	2,066	402058,257	0,915	17,062	10316,532	40,002
07/08/2018 22:00	2,509	403880,509	0,911	16,12	10335,19	39,999
07/08/2018 23:00	2,87	405151,637	0,921	16,102	10330,358	40,002
08/08/2018 00:00	3,319	406038,443	0,949	15,709	10327,098	39,999
08/08/2018 01:00	3,462	406452,315	0,921	15,266	10328,251	39,999
08/08/2018 02:00	4,206	408081,882	0,945	15,005	10323,878	40,001
08/08/2018 03:00	3,835	407178,416	0,925	15,303	10319,216	39,998
08/08/2018 04:00	2,985	404568,731	0,898	15,884	10326,05	39,997
08/08/2018 05:00	2,58	405357,613	0,893	16,155	10314,621	40,002
08/08/2018 06:00	2,425	406728,766	0,891	16,342	10340,422	39,998
08/08/2018 07:00	7,662	409491,906	0,899	14,126	10322,614	39,998
08/08/2018 08:00	5,933	388002,768	12,338	14,318	10321,425	40,005
08/08/2018 09:00	3,291	272839,094	56,5	15,63	10275,408	39,998
08/08/2018 10:00	2,132	268107,887	17,757	16,779	10270,713	40,002
08/08/2018 11:00	2,186	262708,466	1,068	17,535	10277,033	39,998
08/08/2018 12:00	2,621	263631,301	66,66	15,941	10260,352	39,999
08/08/2018 13:00	2,512	270131,197	66,627	15,885	10254,668	39,964
08/08/2018 14:00	2,184	273000,279	65,735	15,89	10248,76	39,999
08/08/2018 15:00	2,019	275791,332	15,275	15,847	10228,998	39,997
08/08/2018 16:00	2,053	278196,721	0,347	15,678	10213,685	39,997
08/08/2018 17:00	2,07	281483,652	0,171	15,959	10210,32	39,855
08/08/2018 18:00	1,999	275755,794	0,095	15,539	10247,358	40
08/08/2018 19:00	2,032	273069,074	0,099	15,507	10250,376	39,999
08/08/2018 20:00	2,045	271586,291	0,095	15,134	10259,809	40,002
08/08/2018 21:00	2,107	273494,815	0,096	15,53	10273,366	39,998
08/08/2018 22:00	4,173	336747,841	0,322	16,073	10655,791	41,701
08/08/2018 23:00	2,107	298448,05	0,09	15,625	10304,871	40,001
09/08/2018 00:00	2,149	338433,849	0,497	15,537	10309,347	39,999
09/08/2018 01:00	2,142	399813,652	0,954	15,453	10324,579	40,001
09/08/2018 02:00	2,218	401374,76	0,946	15,327	10323,161	40,002
09/08/2018 03:00	2,161	400711,255	0,943	15,467	10325,914	39,996
09/08/2018 04:00	2,141	401354,041	0,951	15,422	10325,476	40
09/08/2018 05:00	2,233	396472,628	0,342	15,397	10314,688	39,997
09/08/2018 06:00	2,255	316209,155	0,339	15,408	10334,58	40
09/08/2018 07:00	2,127	400353,349	0,959	15,596	10303,86	39,999
09/08/2018 08:00	2,129	400193,521	0,969	15,47	10282,292	40,001
09/08/2018 09:00	2,253	399283,446	0,892	15,535	10301,508	40
09/08/2018 10:00	2,234	397784,723	0,934	15,703	10286,856	40,001
09/08/2018 11:00	10,472	395776,248	0,814	17,794	10305,563	39,986
09/08/2018 12:00	14,561	398970,693	0,771	16,193	10333,256	39,997
09/08/2018 13:00	14,165	399630,655	0,769	16,135	10329,919	40,001
09/08/2018 14:00	16,019	401194,755	0,785	16,37	10318,501	39,994
09/08/2018 15:00	18,605	401695,86	0,783	16,453	10310,415	39,997
09/08/2018 16:00	19,849	403485,341	0,78	16,354	10338,69	40,001
09/08/2018 17:00	20,646	404574,253	0,779	16,405	10363,771	40,002
09/08/2018 18:00	16,919	402990,658	0,791	16,156	10372,691	39,999
09/08/2018 19:00	17,619	402994,398	0,78	16,051	10362,317	39,999
09/08/2018 20:00	17,179	403457,489	0,793	16,308	10359,079	39,996

09/08/2018 21:00	21,782	405025,678	0,8	16,088	10360,487	40
09/08/2018 22:00	27,417	405783,111	0,807	15,826	10359,875	40,002
09/08/2018 23:00	33,956	405952,238	0,803	15,849	10359,113	39,996
10/08/2018 00:00	32,284	406950,65	0,806	16,08	10361,669	39,999
10/08/2018 01:00	33,536	406836,454	0,804	16,062	10358,537	40,001
10/08/2018 02:00	19,535	405660,712	0,79	15,428	10367,751	40,002
10/08/2018 03:00	2,886	403767,701	0,8	15,055	10372,236	40,001
10/08/2018 04:00	2,796	404193,823	0,791	14,963	10394,849	39,994
10/08/2018 05:00	2,501	400855,528	0,783	14,964	10384,995	40,002
10/08/2018 06:00	3,072	402899,099	0,795	15,042	10350,958	40
10/08/2018 07:00	2,745	402575,82	0,785	15,152	10378,894	39,998
10/08/2018 08:00	20,26	405379,564	0,799	15,281	10384,692	40,002
10/08/2018 09:00	3,06	402800,719	0,726	14,792	10377,133	40,005
10/08/2018 10:00	2,574	401375,322	0,766	14,883	10366,615	39,996
10/08/2018 11:00	2,291	392073,25	1,416	15,849	10197,083	39,222
10/08/2018 12:00	2,129	396018,507	0,821	15,316	10345,704	40,001
10/08/2018 13:00	2,073	395510,95	0,807	15,181	10327,367	39,999
10/08/2018 14:00	2,061	396038,257	0,815	15,268	10333,913	40,004
10/08/2018 15:00	4,796	398245,42	0,814	17,183	10355,167	39,994
10/08/2018 16:00	9,934	402087,63	0,815	16,596	10372,855	40,001
10/08/2018 17:00	11,066	403095,192	0,821	16,314	10365,781	39,998
10/08/2018 18:00	13,236	403569,994	0,808	16,378	10329,408	39,998
10/08/2018 19:00	14,393	403809,587	0,807	16,694	10346,75	40
10/08/2018 20:00	18,936	404625,297	0,828	16,451	10353,39	39,998
10/08/2018 21:00	19,786	404655,907	0,824	16,39	10359,724	40,003
10/08/2018 22:00	21,126	404900,027	0,829	16,406	10357,155	39,998
10/08/2018 23:00	18,382	402714,847	0,841	17,06	10358,452	40,002
11/08/2018 00:00	23,165	403645,234	0,861	16,39	10351,222	40,002
11/08/2018 01:00	24,917	403864,614	0,846	16,315	10344,212	40,005
11/08/2018 02:00	25,337	403666,011	0,849	16,371	10353,146	40,003
11/08/2018 03:00	27,341	403753,249	0,842	16,211	10354,48	39,998
11/08/2018 04:00	32,336	404286,422	0,836	16,051	10354,261	40,004
11/08/2018 05:00	97,086	358515,586	0,755	14,544	8922,099	31,656
11/08/2018 06:00	41,197	0	5,84	1,516	233,665	0
11/08/2018 07:00		0	0	0,145	0	0
11/08/2018 08:00		0	0	0,073	0	0
11/08/2018 09:00		0	0	0,116	0	0
11/08/2018 10:00		0	0	0,094	0	0
11/08/2018 11:00		0	0	0,073	0	0
11/08/2018 12:00		0	0	0,044	0	0
11/08/2018 13:00		0	0	0,035	0	0
11/08/2018 14:00		0	0	0,024	0	0
11/08/2018 15:00		0	0	0,02	0	0
11/08/2018 16:00		0	0	0,016	0	0
11/08/2018 17:00		0	0	0,014	0	0
11/08/2018 18:00		0	0	0,019	0	0
11/08/2018 19:00		0	0	0,035	0	0
11/08/2018 20:00		0	0	0,037	0	0
11/08/2018 21:00		0	0,291	1,352	2168,314	5,673
11/08/2018 22:00	5,9	302986,486	0,587	14,627	10390,539	39,996
11/08/2018 23:00	2,38	400118,191	0,873	14,541	10395,704	40
12/08/2018 00:00	2,332	401021,217	0,889	14,393	10386,285	40,001
12/08/2018 01:00	2,29	401024,21	0,889	14,393	10386,285	40,001
12/08/2018 02:00	2,306	401546,769	0,889	14,277	10390,492	40
12/08/2018 03:00	2,676	401945,32	0,879	14,074	10388,35	40,004
12/08/2018 04:00	2,593	402019,321	0,874	14,14	10393,989	40,001
12/08/2018 05:00	2,518	401185,603	0,9	14,149	10396,591	40,001
12/08/2018 06:00	2,87	403487,371	0,887	14,217	10392,968	40,002
12/08/2018 07:00	2,783	402742,461	0,864	14,228	10396,154	40
12/08/2018 08:00	2,495	402507,208	0,864	14,231	10390,158	39,999
12/08/2018 09:00	3,014	402686,012	0,814	13,659	10369,673	40,001
12/08/2018 10:00	2,453	401576,906	0,87	13,76	10363,921	39,998
12/08/2018 11:00	2,317	400911,079	1,41	13,861	10364,895	40
12/08/2018 12:00	2,281	399414,986	0,874	14,006	10354,909	39,999
12/08/2018 13:00	2,205	399923,517	0,893	14,036	10352,446	39,997
12/08/2018 14:00	2,204	399298,394	0,887	14,458	10348,429	39,999
12/08/2018 15:00	2,133	400221,615	0,88	14,164	10342,707	40,003
12/08/2018 16:00	2,128	400637,094	0,872	14,157	10350,15	40,001
12/08/2018 17:00	2,146	400015,315	0,871	14,247	10359,715	39,996
12/08/2018 18:00	10,842	388171,265	0,9	13,173	10109,987	38,603
12/08/2018 19:00	33,296	367963,335	0,921	10,769	9379,848	35
12/08/2018 20:00	35,326	368063,925	0,93	10,907	9388,785	35,001
12/08/2018 21:00	40,214	370576,909	0,925	10,882	9399,424	35
12/08/2018 22:00	50,985	372193,73	0,927	10,708	9401,207	34,997
12/08/2018 23:00	55,987	373165,407	0,912	10,668	9396,282	35,005
13/08/2018 00:00	43,495	377288,737	0,916	10,4	9545,662	35,78
13/08/2018 01:00	46,439	379764,178	0,933	10,318	9597,889	36,001
13/08/2018 02:00	48,648	379652,61	0,925	10,31	9597,787	35,998
13/08/2018 03:00	48,122	379685,05	0,923	10,258	9595,826	36,001
13/08/2018 04:00	47,422	380051,79	0,913	10,335	9590,492	35,999
13/08/2018 05:00	45,523	383279,455	0,916	10,466	9601,264	35,999
13/08/2018 06:00	45,202	380623,227	0,925	10,55	9614,197	36,001
13/08/2018 07:00	42,964	385205,832	0,911	10,46	9719,567	36,618
13/08/2018 08:00	36,726	387418,612	0,911	10,592	9813,404	37,001
13/08/2018 09:00	9,592	399097,779	0,849	13,269	10272,349	39,419
13/08/2018 10:00	2,822	402554,571	0,887	14,618	10423,811	39,999
13/08/2018 11:00	2,311	401017,241	0,889	15,092	10398,183	40,001
13/08/2018 12:00	2,062	398075,877	0,913	15,612	10389,916	39,997
13/08/2018 13:00	2,023	397545,96	0,913	15,878	10393,223	40,003
13/08/2018 14:00	2,023	397672,084	0,921	15,99	10377,552	40,002
13/08/2018 15:00	2,02	397257,118	0,92	16,175	10363,803	40
13/08/2018 16:00	2,021	397745,388	0,927	16,254	10363,158	39,999
13/08/2018 17:00	2,033	397733,429	0,92	16,045	10368,176	39,999
13/08/2018 18:00	2,172	398175,11	0,927	15,417	10385,335	39,995
13/08/2018 19:00	2,23	399550,91	0,937	14,924	10403,405	39,996
13/08/2018 20:00	2,425	401260,913	0,968	14,867	10407,608	40
13/08/2018 21:00	2,453	401713,208	0,959	14,887	10412,964	39,999
13/08/2018 22:00	2,29	401968,408	0,943	14,739	10418,204	39,999
13/08/2018 23:00	2,968	403166,845	0,96	14,765	10405,562	40,003
14/08/2018 00:00	28,136	389324,482	0,983	12,231	9919,526	37,532
14/08/2018 01:00	38,609	384023,147	0,979	10,732	9711,836	36,501
14/08/2018 02:00	44,707	383233,133	0,978	10,597	9734,514	36,5

14/08/2018 03:00	49,006	383641,787	0,977	10,474	9739,473	36,504
14/08/2018 04:00	54,667	384086,532	0,985	10,512	9714,963	36,496
14/08/2018 05:00	49,906	382262,779	0,963	10,52	9726,059	36,501
14/08/2018 06:00	31,012	394771,076	0,936	11,682	10026,962	37,959
14/08/2018 07:00	7,01	405672,974	0,938	13,674	10419,418	40
14/08/2018 08:00	3,583	404474,112	0,929	14,309	10419,938	39,999
14/08/2018 09:00	4,184	403698,109	0,866	14,341	10382,385	40
14/08/2018 10:00	2,242	401079,117	0,898	15,209	10395,875	39,998
14/08/2018 11:00	2,201	396183,665	0,922	16,32	10394,805	39,994
14/08/2018 12:00	2,236	388525,951	0,823	16,559	10315,932	39,616
14/08/2018 13:00	2,308	385251,175	0,836	16,466	10209,869	39,095
14/08/2018 14:00	2,329	379077,178	0,837	16,431	10008,627	38,094
14/08/2018 15:00	2,249	377782,922	0,849	16,552	9984,798	37,706
14/08/2018 16:00	2,33	385172,974	0,839	16,227	10021,381	38,527
14/08/2018 17:00	2,177	398983,379	0,843	14,52	10321,105	40,003
14/08/2018 18:00	2,605	400058,108	0,857	14,105	10347,599	40
14/08/2018 19:00	2,433	399164,51	0,876	14,463	10369,641	39,997
14/08/2018 20:00	2,213	395679,233	0,863	16,619	10403,672	39,996
14/08/2018 21:00	2,189	396432,921	0,86	16,809	10407,813	40,004
14/08/2018 22:00	2,156	396948,414	0,862	16,65	10403,072	39,994
14/08/2018 23:00	2,433	398249,129	0,86	16,306	10413,726	39,998
15/08/2018 00:00	2,26	396994,6	0,867	16,591	10415,759	40,003
15/08/2018 01:00	2,172	398143,776	0,866	16,273	10413,63	39,998
15/08/2018 02:00	2,206	398870,793	0,836	15,879	10411,1	40,001
15/08/2018 03:00	2,197	398378,974	0,819	16,123	10417,062	40,001
15/08/2018 04:00	2,272	398421,524	0,842	16,187	10417,37	39,999
15/08/2018 05:00	2,244	405386,42	0,853	15,769	10414,09	40,002
15/08/2018 06:00	2,45	401024,046	0,846	15,219	10413,385	40
15/08/2018 07:00	3,39	403087,073	0,863	14,203	10406,081	40,003
15/08/2018 08:00	4,663	403577,945	0,869	13,537	10395,308	40,003
15/08/2018 09:00	4,368	401418,929	0,817	13,19	10373,237	40,002
15/08/2018 10:00	2,571	399486,467	0,856	13,832	10345,297	39,998
15/08/2018 11:00	2,491	396429,639	0,858	14,306	10331,605	39,968
15/08/2018 12:00	2,216	395525,812	0,812	14,435	10328,788	40,003
15/08/2018 13:00	2,512	392872,835	0,791	14,908	10306,102	39,644
15/08/2018 14:00	2,078	395606,174	0,819	14,737	10395,007	40,001
15/08/2018 15:00	2,063	394103,056	0,824	14,688	10305,205	40,001
15/08/2018 16:00	2,055	394845,426	0,817	14,651	10317,145	40,003
15/08/2018 17:00	2,109	395888,527	0,811	14,606	10335,543	39,999
15/08/2018 18:00	2,367	397802,955	0,812	14,522	10387,746	40
15/08/2018 19:00	2,273	399010,052	0,819	14,452	10418,873	39,998
15/08/2018 20:00	2,361	399614,868	0,846	14,053	10419,754	40,001
15/08/2018 21:00	2,473	400737,89	0,83	13,98	10427,494	40
15/08/2018 22:00	2,37	400590,501	0,831	13,962	10432,447	40,001
15/08/2018 23:00	2,403	398621,019	0,833	14,289	10443,545	39,961
16/08/2018 00:00	2,324	394998,505	0,829	16,376	10445,587	39,902
16/08/2018 01:00	2,298	395015,604	0,827	16,196	10439,853	39,853
16/08/2018 02:00	2,35	396097,864	0,833	16,023	10466,599	39,994
16/08/2018 03:00	2,35	396975,744	0,833	15,917	10463,322	40,002
16/08/2018 04:00	2,295	397400,745	0,83	15,861	10451,137	39,995
16/08/2018 05:00	2,335	388393,729	0,825	15,784	10449,499	39,997
16/08/2018 06:00	2,937	401967,191	0,831	14,673	10432,107	40,001
16/08/2018 07:00	2,96	402738,861	0,808	14,22	10423,681	40,002
16/08/2018 08:00	2,989	402315,84	0,813	13,731	10423,812	39,996
16/08/2018 09:00	5,819	398105,631	0,783	12,656	10296,356	39,37
16/08/2018 10:00	5,97	387406,033	0,829	12,328	10005,554	37,999
16/08/2018 11:00	5,741	385485,158	0,833	12,033	10027,348	38,003
16/08/2018 12:00	4,224	383508,064	1,356	12,121	10025,988	37,999
16/08/2018 13:00	4,365	383473,34	0,875	12,16	10012,674	38,033
16/08/2018 14:00	2,753	383895,486	0,892	12,356	9978,37	38,002
16/08/2018 15:00	13,046	384876,645	0,895	13,962	9954,792	37,999
16/08/2018 16:00	14,603	385615,042	0,893	12,812	9947,156	38,002
16/08/2018 17:00	2,665	385637,941	0,881	12,269	9977,284	38
16/08/2018 18:00	2,753	384415,145	0,887	12,368	10013,263	38,003
16/08/2018 19:00	3,149	384687,17	0,895	12,448	10033,525	38
16/08/2018 20:00	3,593	385481,551	0,912	12,464	10039,262	37,996
16/08/2018 21:00	5,447	388117,103	0,923	12,305	10044,069	38,002
16/08/2018 22:00	6,826	388363,231	0,929	12,312	10046,135	37,999
16/08/2018 23:00	8,827	388789,849	0,926	12,197	10039,463	38
17/08/2018 00:00	3,462	386779,586	0,911	13,414	10057,521	37,997
17/08/2018 01:00	2,339	386279,854	0,92	13,798	10058,117	38,001
17/08/2018 02:00	4,058	388011,621	0,919	13,475	10061,396	37,995
17/08/2018 03:00	5,063	387821,247	0,905	13,217	10054,408	38,001
17/08/2018 04:00	3,76	387436,452	0,897	13,273	10053,614	37,998
17/08/2018 05:00	6,29	390675,49	0,91	12,94	10044,509	38
17/08/2018 06:00	5,553	387892,782	0,901	12,963	10058,89	38
17/08/2018 07:00	5,095	388221,525	0,893	13,021	10047,278	38,002
17/08/2018 08:00	6,535	388645,214	0,912	12,963	10038,725	38,002
17/08/2018 09:00	6,206	405344,439	0,815	14,828	10554,971	40,66
17/08/2018 10:00	2,151	221155,1	1,661	9,659	5403,347	20,161
17/08/2018 11:00		0	0	0,156	0	0
17/08/2018 12:00		0	0	0,118	0	0
17/08/2018 13:00		0	0	0,107	0	0
17/08/2018 14:00		0	0	0,077	0	0
17/08/2018 15:00		0	0	0,047	0	0
17/08/2018 16:00		0	0	0,052	0	0
17/08/2018 17:00		5707,386	0,296	7,175	6259,174	23,452
17/08/2018 18:00	8,521	252511,95	0,465	12,182	9789,648	36,841
17/08/2018 19:00	13,702	376615,562	0,839	11,212	9638,307	36,002
17/08/2018 20:00	16,085	377341,642	0,836	11,072	9641,278	35,999
17/08/2018 21:00	18,972	378316,574	0,844	10,911	9647,799	36,003
17/08/2018 22:00	42,515	351003,535	0,761	10,87	9514,696	35,201
17/08/2018 23:00	74,251	0	0,932	2,982	1423,306	2,727
18/08/2018 00:00		0	0	0,114	0	0
18/08/2018 01:00		0	0	0,06	0	0
18/08/2018 02:00		0	0	0,045	0	0
18/08/2018 03:00		0	0	0,038	0	0
18/08/2018 04:00		0	0	0,036	0	0
18/08/2018 05:00		0	0	0,048	0	0
18/08/2018 06:00		0	0	0,054	0	0
18/08/2018 07:00		0	0	0,04	0	0
18/08/2018 08:00		0	0	0,041	0	0

18/08/2018 09:00		0	0	0,042	0	0
18/08/2018 10:00		0	0	0,03	0	0
18/08/2018 11:00		0	0	0,036	0	0
18/08/2018 12:00		0	0	0,027	0	0
18/08/2018 13:00		0	0	0,014	0	0
18/08/2018 14:00		0	0	0,01	0	0
18/08/2018 15:00		0	0	0,006	0	0
18/08/2018 16:00		0	0	0,003	0	0
18/08/2018 17:00		0	0	0	0	0
18/08/2018 18:00		0	0	0	0	0
18/08/2018 19:00		0	0	0	0	0
18/08/2018 20:00		0	0,344	1,754	2992,259	8,155
18/08/2018 21:00	37,557	0	0,266	3,676	9662,361	36,002
18/08/2018 22:00	35,996	0	0,122	7,204	9642,62	35,997
18/08/2018 23:00	63,395	0	0,085	10,177	9640,788	36,001
19/08/2018 00:00	30,674	0	1,321	1,886	1305,143	2,326
19/08/2018 01:00		0	0	0,131	0	0
19/08/2018 02:00		0	0	0,041	0	0
19/08/2018 03:00		0	0	0,033	0	0
19/08/2018 04:00		0	0	0,027	0	0
19/08/2018 05:00		0	0	0,021	0	0
19/08/2018 06:00		0	0	0,024	0	0
19/08/2018 07:00		0	0	0,021	0	0
19/08/2018 08:00		0	0	0,024	0	0
19/08/2018 09:00		0	0	0,025	0	0
19/08/2018 10:00		0	0	0,015	0	0
19/08/2018 11:00		4598,448	0,241	4,906	4930,576	15,846
19/08/2018 12:00	8,42	353588,465	1,363	12,195	9634,648	36,001
19/08/2018 13:00	3,602	375812,968	0,953	13,119	9625,417	35,999
19/08/2018 14:00	2,55	375654,383	0,961	13,656	9666,048	36,001
19/08/2018 15:00	2,335	376043,583	0,95	13,891	9626,152	35,999
19/08/2018 16:00	2,31	376680,792	0,949	13,913	9586,889	35,999
19/08/2018 17:00	2,388	377026,803	0,946	13,94	9591,633	36,001
19/08/2018 18:00	3,606	378650,767	0,945	13,528	9607,266	35,997
19/08/2018 19:00	6,943	379545,732	0,946	12,758	9629,501	36
19/08/2018 20:00	9,384	380158,964	0,968	12,333	9643,739	36
19/08/2018 21:00	15,693	381015,928	0,976	11,65	9652,908	35,999
19/08/2018 22:00	16,955	381455,079	0,984	11,487	9654,989	36,002
19/08/2018 23:00	14,903	379306,795	0,974	11,593	9655,971	36,001
20/08/2018 00:00	15,488	379442,712	0,974	11,499	9661,467	36,001
20/08/2018 01:00	18,224	379996,954	0,981	11,298	9657,667	35,998
20/08/2018 02:00	18,697	380344,53	0,968	11,316	9660,17	36
20/08/2018 03:00	18,066	381263,022	0,96	11,275	9663,739	36
20/08/2018 04:00	18,926	381338,715	0,957	11,236	9650,727	36,002
20/08/2018 05:00	8,913	385098,865	0,959	12,388	9639,051	35,997
20/08/2018 06:00	13,807	380396,571	0,986	11,704	9644,393	35,999
20/08/2018 07:00	21,247	383806,586	0,973	11,445	9763,093	36,312
20/08/2018 08:00	2,45	404319,956	0,94	15,196	10477,034	40,001
20/08/2018 09:00	2,27	402430,383	0,865	16,044	10465,27	40
20/08/2018 10:00	2,279	400338,634	0,928	16,969	10414,053	39,998
20/08/2018 11:00	2,364	391401,761	0,923	17,196	10282,886	39,152
20/08/2018 12:00	2,313	381019,882	0,9	17,192	10009,185	37,819
20/08/2018 13:00	2,337	374878,136	0,83	17,131	9822,762	36,953
20/08/2018 14:00	19,778	354851,69	0,859	15,149	9033,627	33,115
20/08/2018 15:00	28,99	340455,648	0,874	14,123	8503,189	30,498
20/08/2018 16:00	19,43	355504,191	0,863	14,658	9072,204	33,238
20/08/2018 17:00	2,302	372804,349	0,835	14,186	9649,122	36,005
20/08/2018 18:00	2,542	374737,664	0,831	13,733	9616,902	36,004
20/08/2018 19:00	3,976	376591,618	0,839	13,265	9633,118	36,002
20/08/2018 20:00	4,307	376782,806	0,874	13,179	9642,618	35,997
20/08/2018 21:00	6,375	377899,01	0,867	12,833	9650,804	36,001
20/08/2018 22:00	7,092	377362,763	0,877	12,712	9650,593	36,01
20/08/2018 23:00	9,238	378552,07	0,865	12,036	9653,286	35,999
21/08/2018 00:00	14,804	380679,233	0,869	11,415	9654,856	35,998
21/08/2018 01:00	15,358	380337,946	0,867	11,481	9654,024	35,999
21/08/2018 02:00	12,226	380229,528	0,855	11,702	9652,529	36,005
21/08/2018 03:00	9,176	379553,374	0,863	11,947	9654,959	36
21/08/2018 04:00	17,068	380758,152	0,869	11,464	9641,384	35,999
21/08/2018 05:00	18,073	380913,371	0,84	11,218	9672,14	36,001
21/08/2018 06:00	17,64	380944,845	0,843	11,158	9659,016	36,002
21/08/2018 07:00	10,673	379696,818	0,851	11,828	9667,203	36
21/08/2018 08:00	12,956	379334,41	0,85	11,743	9626,645	36,004
21/08/2018 09:00	5,677	376515,452	0,777	12,845	9651,797	36,002
21/08/2018 10:00	2,604	373931,048	0,856	13,795	9638,762	36,003
21/08/2018 11:00	2,381	371342,888	0,842	14,495	9637,495	36,003
21/08/2018 12:00	2,422	368817,85	1,314	14,926	9687,818	36,007
21/08/2018 13:00	2,367	368728,832	0,858	15,471	9698,55	35,999
21/08/2018 14:00	2,378	369013,85	0,856	15,722	9659,121	35,997
21/08/2018 15:00	2,38	371231,324	0,853	14,704	9657,796	36,002
21/08/2018 16:00	2,453	373884,6	0,851	13,697	9695,506	36
21/08/2018 17:00	2,44	374075,894	0,859	13,489	9614,279	36
21/08/2018 18:00	4,656	376752,046	0,873	12,757	9613,383	36
21/08/2018 19:00	9,558	378262,067	0,856	11,989	9625,021	36,003
21/08/2018 20:00	13,25	379165,152	0,871	11,644	9638,337	36,005
21/08/2018 21:00	15,674	380352,508	0,883	11,354	9650,099	36,003
21/08/2018 22:00	22,963	380961,787	0,869	11,017	9643,105	35,999
21/08/2018 23:00	27,583	381696,665	0,875	10,794	9646,152	35,998
22/08/2018 00:00	25,16	381612,631	0,874	10,82	9658,959	35,998
22/08/2018 01:00	31,666	382373,059	0,878	10,671	9659,309	36,002
22/08/2018 02:00	29,858	382353,014	0,876	10,647	9662,407	35,999
22/08/2018 03:00	26,116	382573,024	0,885	10,668	9661,108	36,002
22/08/2018 04:00	28,592	382372,424	0,868	10,66	9653,27	36,003
22/08/2018 05:00	22,528	381453,675	0,858	11,636	9673,028	35,999
22/08/2018 06:00	27,736	382769,831	0,857	11,189	9650,707	36,002
22/08/2018 07:00	18,527	381177,311	0,859	11,582	9653,989	36
22/08/2018 08:00	37,296	383216,973	0,868	10,797	9609,165	35,998
22/08/2018 09:00	25,177	381903,512	0,793	10,879	9630,489	35,993
22/08/2018 10:00	13,245	379406,751	0,867	11,701	9641,501	36,001
22/08/2018 11:00	11,127	379423,384	0,868	11,934	9642,409	35,996
22/08/2018 12:00	9,197	378744,211	0,874	12,141	9630,586	35,999
22/08/2018 13:00	20,916	380730,469	0,844	11,208	9626,718	35,999
22/08/2018 14:00	19,623	380263,926	0,837	11,108	9629,283	36,002

22/08/2018 15:00	26,431	381163,943	0,842	10,769	9629,046	36,001
22/08/2018 16:00	34,824	381389,945	0,839	10,489	9639,646	36,001
22/08/2018 17:00	38,864	381458,467	0,859	10,403	9647,159	36,001
22/08/2018 18:00	46,285	382496,793	0,85	10,359	9642,663	36,004
22/08/2018 19:00	58,97	382634,774	0,887	10,222	9654,479	35,997
22/08/2018 20:00	66,629	384448,694	0,854	10,134	9665,137	35,997
22/08/2018 21:00	56,839	387465,033	0,846	10,151	9752,365	36,407
22/08/2018 22:00	45,73	391075,997	0,843	10,261	9881,106	36,999
22/08/2018 23:00	44,014	390825,294	0,839	10,294	9874,766	37,001
23/08/2018 00:00	41,02	388584,122	0,85	10,253	9873,518	37,004
23/08/2018 01:00	45,863	390093,176	0,861	10,207	9871,304	37,006
23/08/2018 02:00	46,094	389926,173	0,833	10,206	9868,745	37
23/08/2018 03:00	41,463	389535,548	0,855	10,229	9870,679	36,999
23/08/2018 04:00	45,932	390229,231	0,853	10,175	9862,623	37
23/08/2018 05:00	44,666	389754,008	0,841	10,135	9878,095	37,004
23/08/2018 06:00	43,099	389803,243	0,848	10,221	9845,271	37
23/08/2018 07:00	255,785	208787,228	1,164	7,814	5493,4	16,717
23/08/2018 08:00		0	0	0,279	0	0
23/08/2018 09:00		0	0	0,138	0	0
23/08/2018 10:00		0	0	4,044	0	0
23/08/2018 11:00		0	0	0,05	0	0
23/08/2018 12:00		0	0	0,03	0	0
23/08/2018 13:00		0	0	0,017	0	0
23/08/2018 14:00		0	0	0,013	0	0
23/08/2018 15:00		0	0,31	1,074	2573,585	6,441
23/08/2018 16:00	88,49	182093,033	0,405	9,032	9564,187	35,294
23/08/2018 17:00	22,834	412758,489	0,969	11,872	10486,574	40,003
23/08/2018 18:00	27,778	412132,318	0,89	11,524	10477,395	39,999
23/08/2018 19:00	28,977	411652,904	0,915	11,38	10478,863	39,996
23/08/2018 20:00	26,333	411919,606	0,927	11,454	10486,863	39,998
23/08/2018 21:00	23,79	411665,271	0,917	11,634	10497,435	40,001
23/08/2018 22:00	20,841	410998,25	0,908	11,887	10515,842	40,003
23/08/2018 23:00	26,848	411753,817	0,928	11,465	10509,369	40,003
24/08/2018 00:00	26,799	413391,769	0,902	11,511	10507,362	40
24/08/2018 01:00	29,868	412483,215	0,934	11,372	10505,169	40,003
24/08/2018 02:00	30,908	412956,425	0,924	11,349	10501,707	39,998
24/08/2018 03:00	35,462	413206,648	0,924	11,225	10508,439	40,001
24/08/2018 04:00	42,75	414014,707	0,935	11,106	10506,934	40,003
24/08/2018 05:00	44,809	413854,104	0,953	11,051	10519,655	40,002
24/08/2018 06:00	45,469	414688,667	0,936	11,195	10501,405	40
24/08/2018 07:00	264,404	112563,791	0,454	9,021	5918,97	17,42
24/08/2018 08:00		0	0	0,489	0	0
24/08/2018 09:00		0	0	0,087	0	0
24/08/2018 10:00		0	0	0,057	0	0
24/08/2018 11:00		0	0	0,067	0	0
24/08/2018 12:00		0	0	0,063	0	0
24/08/2018 13:00	162,053	159081,124	57,423	9,881	7104,728	24,442
24/08/2018 14:00	2,249	402154,122	0,906	17,427	10485,273	39,999
24/08/2018 15:00	6,803	412747,815	0,936	16,907	10969,896	42,842
24/08/2018 16:00	3,482	429832,899	0,919	16,986	11987,682	47,815
24/08/2018 17:00	4,22	405650,87	0,941	14,555	10419,914	39,999
24/08/2018 18:00	5,563	406089,88	0,93	14,479	10439,259	40,001
24/08/2018 19:00	6,846	406378,38	0,941	14,252	10466,329	40,001
24/08/2018 20:00	2,855	404760,25	0,952	15,504	10485,746	40,001
24/08/2018 21:00	2,981	405342,178	0,956	15,381	10493,581	39,999
24/08/2018 22:00	4,134	406009,118	0,947	15,134	10502,18	40,001
24/08/2018 23:00	5,388	406633,463	0,936	14,746	10500,687	40,002
25/08/2018 00:00	5,43	406685,387	0,934	14,692	10507,637	40,004
25/08/2018 01:00	5,713	405390,089	0,926	14,667	10511,664	39,996
25/08/2018 02:00	4,59	404972,562	0,925	14,848	10514,773	40,001
25/08/2018 03:00	8,642	406368,442	0,938	13,943	10504,371	39,999
25/08/2018 04:00	6,891	406184,904	0,907	14,387	10504,889	40,001
25/08/2018 05:00	14,889	408506,046	0,914	12,864	10493,425	39,997
25/08/2018 06:00	13,323	408045,498	0,91	13,021	10483,292	40
25/08/2018 07:00	9,821	407432,398	0,894	13,646	10492,616	39,999
25/08/2018 08:00	7,322	406558,699	0,909	14,39	10496,712	39,999
25/08/2018 09:00	3,104	404037,218	0,835	15,52	10495,735	40
25/08/2018 10:00	2,429	401926,195	0,893	16,058	10482,474	39,998
25/08/2018 11:00	2,391	399686,708	0,883	16,824	10475,902	40
25/08/2018 12:00	4,694	400064,082	0,914	19,362	10443,944	40,003
25/08/2018 13:00	3,081	399628,169	1,288	20,563	10436,765	39,999
25/08/2018 14:00	2,476	402532,082	0,832	21,083	10606,895	41,073
25/08/2018 15:00	1,958	427116,363	0,803	16,438	12383,552	50
25/08/2018 16:00	1,943	426370,105	0,78	16,459	12394,525	49,999
25/08/2018 17:00	1,968	426330,797	0,791	16,392	12402,663	50,004
25/08/2018 18:00	2,099	426647,828	0,793	15,985	12433,931	49,999
25/08/2018 19:00	2,247	427180,963	0,796	16,592	12460,916	49,996
25/08/2018 20:00	21,955	398756,539	0,86	13,462	10701,951	40,977
25/08/2018 21:00	37,123	390291,809	0,87	12,11	9959,244	37,447
25/08/2018 22:00	42,15	407151,799	0,863	15,404	10447,152	40,003
25/08/2018 23:00	6,476	399811,729	0,843	16,783	10489,278	40
26/08/2018 00:00	2,404	398321,211	0,846	16,684	10498,01	40
26/08/2018 01:00	2,472	399890,928	0,845	16,238	10490,44	39,998
26/08/2018 02:00	2,428	399525,903	0,814	16,465	10495,092	39,998
26/08/2018 03:00	2,503	399489,569	0,804	16,432	10500,671	39,994
26/08/2018 04:00	2,443	399491,36	0,821	16,603	10502,73	39,998
26/08/2018 05:00	2,603	392960,4	0,836	15,393	10264,949	38,852
26/08/2018 06:00	2,908	389097,507	0,832	14,449	10093,706	38
26/08/2018 07:00	2,843	389877,668	0,831	14,391	10086,621	38,001
26/08/2018 08:00	7,264	390778,843	0,819	13,424	10076,385	37,997
26/08/2018 09:00	11,809	390592,922	0,789	12,059	10036,171	37,999
26/08/2018 10:00	4,911	386176,617	0,846	13,685	10006,797	37,921
26/08/2018 11:00	3,586	384929,193	0,851	13,22	9997,311	37,999
26/08/2018 12:00	3,271	383333,704	0,843	13,206	9991,398	38,001
26/08/2018 13:00	2,837	383381,134	0,821	13,289	9986,656	37,997
26/08/2018 14:00	2,551	383579,043	0,798	13,285	9975,883	38
26/08/2018 15:00	2,416	383711,505	0,79	13,425	9961,287	37,999
26/08/2018 16:00	10,299	385293,613	0,801	13,923	9956,442	37,989
26/08/2018 17:00	12,867	387225,751	0,809	13,569	9946,161	37,997
26/08/2018 18:00	3,94	388325,778	0,805	13,449	9990,675	37,999
26/08/2018 19:00	3,985	399220,316	0,802	15,166	10324,473	39,45
26/08/2018 20:00	5,072	416872,222	0,801	18,126	10829,961	41,999

26/08/2018 21:00	9,919	414617,635	0,815	17,39	10765,178	41,532
26/08/2018 22:00	24,325	405968,634	0,816	15,49	10434,696	40,002
26/08/2018 23:00	22,4	405843,94	0,818	16,187	10440,938	40,001
27/08/2018 00:00	34,279	407011,695	0,827	15,491	10440,018	40
27/08/2018 01:00	7,755	401899,584	0,811	19,636	10456,531	40,001
27/08/2018 02:00	13,792	392049,735	0,824	18,446	10101,566	38,285
27/08/2018 03:00	11,722	389927,156	0,822	18,359	10050,156	38
27/08/2018 04:00	22,404	391793,49	0,812	17,999	10039,002	37,997
27/08/2018 05:00	22,262	392018,594	0,822	15,781	10062,939	38
27/08/2018 06:00	12,61	392183,019	0,822	12,334	10054,135	38
27/08/2018 07:00	11,728	392634,319	0,821	12,283	10060,49	37,995
27/08/2018 08:00	19,17	393417,138	0,808	11,271	10022,239	38
27/08/2018 09:00	19,059	392812,085	0,736	11,268	10043,175	38,004
27/08/2018 10:00	8,39	391965,155	0,773	13,037	10101,342	38,001
27/08/2018 11:00	7,196	391580,456	0,768	13,438	10117,499	38,16
27/08/2018 12:00	8,839	383591,19	0,783	12,177	9887,625	37,254
27/08/2018 13:00	15,246	376853,506	1,286	10,904	9644,348	35,999
27/08/2018 14:00	15,647	377718,123	0,882	10,84	9678,247	35,998
27/08/2018 15:00	15,711	378659,938	0,884	10,897	9687,9	36,001
27/08/2018 16:00	16,519	379625,913	0,882	10,834	9581,512	36,004
27/08/2018 17:00	15,733	378855,125	0,882	11,288	9622,53	36,001
27/08/2018 18:00	19,896	379313,644	0,877	11,174	9639,259	35,998
27/08/2018 19:00	28,269	380236,957	0,888	10,882	9656,987	36,002
27/08/2018 20:00	31,652	380796,604	0,887	10,741	9664,013	36,003
27/08/2018 21:00	35,03	381052,579	0,902	10,64	9676,32	36,002
27/08/2018 22:00	37,352	381355,756	0,909	10,527	9676,941	36,004
27/08/2018 23:00	44,722	381865,136	0,901	10,527	9675,982	36,003
28/08/2018 00:00	45,537	382467,194	0,896	10,429	9679,339	36,003
28/08/2018 01:00	45,352	387062,803	0,902	10,572	9800,852	36,65
28/08/2018 02:00	30,631	388297,667	0,887	10,638	9884,565	37,002
28/08/2018 03:00	29,194	388605,101	0,89	10,677	9884,153	36,999
28/08/2018 04:00	37,434	389363,954	0,904	10,59	9873,003	37,007
28/08/2018 05:00	36,038	389262,533	0,898	10,605	9895,983	37,002
28/08/2018 06:00	33,74	388512,206	0,892	10,606	9894,459	37
28/08/2018 07:00	34,362	389070,508	0,9	10,851	9887,956	37,003
28/08/2018 08:00	41,579	389405,245	0,893	10,602	9880,106	36,997
28/08/2018 09:00	23,539	387691,858	0,816	11,465	9840,229	36,999
28/08/2018 10:00	11,608	385630,739	0,894	12,4	9859,303	37,001
28/08/2018 11:00	9,054	384103,566	0,888	12,647	9859,132	36,998
28/08/2018 12:00	5,024	415104,278	0,852	17,14	11025,113	42,483
28/08/2018 13:00	16,263	376468,572	1,279	10,897	9652,12	36,001
28/08/2018 14:00	14,795	376929,859	0,913	10,998	9677,021	36,003
28/08/2018 15:00	6,098	375314,474	0,91	12,653	9626,431	36
28/08/2018 16:00	12,865	378003,889	0,91	11,207	9693,364	36,001
28/08/2018 17:00	13,507	378356,603	0,919	11,186	9617,062	36
28/08/2018 18:00	14,955	378182,309	0,915	11,207	9631,697	36
28/08/2018 19:00	12,027	377709,585	0,909	11,972	9658,031	36,001
28/08/2018 20:00	16,303	378443,276	0,909	11,572	9670,251	35,996
28/08/2018 21:00	20,233	379141,311	0,94	11,109	9675,392	35,998
28/08/2018 22:00	20,788	379139,786	0,939	11,27	9675,633	36
28/08/2018 23:00	24,912	379845,616	0,949	11,127	9672,607	35,997
29/08/2018 00:00	26,315	379295,974	0,944	10,943	9666,097	35,998
29/08/2018 01:00	33,877	379879,745	0,939	10,738	9673,782	35,995
29/08/2018 02:00	37,663	380783,548	0,933	10,754	9674,239	35,999
29/08/2018 03:00	35,202	380598,818	0,93	10,777	9676,679	35,996
29/08/2018 04:00	41,631	381196,23	0,944	10,819	9663,658	36
29/08/2018 05:00	45,897	381653,082	0,948	10,777	9683,281	35,996
29/08/2018 06:00	31,302	387265,797	0,933	11,007	9854,637	36,947
29/08/2018 07:00	26,821	387694,194	0,948	11,204	9879,057	36,999
29/08/2018 08:00	44,265	389111,767	0,939	10,3	9868,186	37,004
29/08/2018 09:00	32,093	386887,896	0,855	10,456	9832,25	37,001
29/08/2018 10:00	13,19	384000,853	0,92	11,667	9841,017	36,998
29/08/2018 11:00	10,79	381739,09	0,909	12,084	9831,259	36,999
29/08/2018 12:00	5,709	379351,777	0,915	12,848	9831,536	37,002
29/08/2018 13:00	7,531	380552,446	1,254	12,503	9819,786	37,004
29/08/2018 14:00	6,423	380796,687	0,889	12,71	9813,945	36,999
29/08/2018 15:00	13,634	384843,125	0,894	11,448	9805,16	37,001
29/08/2018 16:00	10,613	384662,453	0,885	12,13	9807,903	36,997
29/08/2018 17:00	11,46	384200,876	0,878	12,138	9826,606	36,998
29/08/2018 18:00	14,083	384737,838	0,887	11,587	9837,94	36,998
29/08/2018 19:00	13,726	384883,055	0,921	11,695	9848,086	37,002
29/08/2018 20:00	18,898	385787,213	0,933	11,162	9849,272	37
29/08/2018 21:00	21,712	385538,357	0,906	10,983	9857,801	36,999
29/08/2018 22:00	20,06	386104,861	0,885	11,11	9860,028	37,002
29/08/2018 23:00	12,269	382731,741	0,898	12,388	9831,69	36,743
30/08/2018 00:00	22,586	379380,363	0,921	11,176	9668,468	35,998
30/08/2018 01:00	23,004	379324,05	0,934	11,165	9672,024	36
30/08/2018 02:00	29,845	380347,222	0,924	10,969	9668,405	36,002
30/08/2018 03:00	38,162	381183,269	0,916	10,868	9662,927	36,001
30/08/2018 04:00	32,812	381294,335	0,909	10,944	9666,625	36,003
30/08/2018 05:00	35,003	381354,231	0,928	10,955	9676,213	36,002
30/08/2018 06:00	32,073	379989,125	0,926	11,059	9665,944	36
30/08/2018 07:00	9,492	398945,621	0,908	14,287	10350,96	39,357
30/08/2018 08:00	2,605	401612,537	0,882	15,172	10477,47	39,999
30/08/2018 09:00	3,102	401999,277	0,83	14,769	10445,412	40
30/08/2018 10:00	2,871	401622,362	0,875	14,605	10465,337	39,999
30/08/2018 11:00	2,794	401947,068	0,893	14,547	10460,683	40,004
30/08/2018 12:00	2,782	401413,454	0,885	14,492	10445,015	40
30/08/2018 13:00	2,588	401508,404	0,976	14,508	10438,329	40,004
30/08/2018 14:00	2,483	401472,987	0,871	14,532	10434,784	40
30/08/2018 15:00	2,432	401150,042	0,866	14,581	10444,39	39,999
30/08/2018 16:00	2,418	401084,593	0,866	14,625	10448,732	39,999
30/08/2018 17:00	2,406	400852,215	0,858	14,785	10456,123	40,002
30/08/2018 18:00	2,37	399749,7	0,864	15,004	10473,896	39,997
30/08/2018 19:00	2,327	399615,617	0,861	15,3	10487,179	39,999
30/08/2018 20:00	2,397	400279,679	0,856	15,172	10487,846	40
30/08/2018 21:00	2,546	401201,593	0,859	14,83	10484,659	40
30/08/2018 22:00	2,619	401734,562	0,873	14,674	10477,362	40
30/08/2018 23:00	2,906	402241,26	0,885	14,679	10472,406	40
31/08/2018 00:00	3,132	402144,594	0,87	14,665	10470,831	40,001
31/08/2018 01:00	3,827	403048,337	0,886	14,485	10476,066	40
31/08/2018 02:00	4,628	403643,847	0,887	14,273	10473,298	40

31/08/2018 03:00	5,18	404086,152	0,877	14,14	10469,685	40,001
31/08/2018 04:00	5,215	403999,955	0,869	14,166	10467,028	39,999
31/08/2018 05:00	4,881	403976,899	0,876	14,186	10480,79	40,003
31/08/2018 06:00	4,451	404490,883	0,869	14,292	10490,343	39,996
31/08/2018 07:00	4,101	404225,152	0,849	14,302	10491,013	40
31/08/2018 08:00	3,775	404744,443	0,865	14,344	10482,297	40,002
31/08/2018 09:00	3,716	404865,93	0,831	14,385	10452,031	40
31/08/2018 10:00	4,44	404368,273	0,877	14,406	10463,048	40,004
31/08/2018 11:00	3,038	403944,085	0,87	14,496	10454,598	40,004
31/08/2018 12:00		403028,593	0,987	15,527	10453,3	40,001
31/08/2018 13:00		386255,274	1,227	12,756	10458,151	40
31/08/2018 14:00	83,067	403028,593	0,987	15,527	10461,863	40,001
31/08/2018 15:00	2,665	386255,274	1,227	12,756	10461,988	39,998
31/08/2018 16:00	2,529	402671,47	0,887	14,915	10458,033	40,002
31/08/2018 17:00	2,462	402453,251	0,897	14,966	10465,656	39,999
31/08/2018 18:00	2,474	402439,993	0,901	14,978	10467,351	40
31/08/2018 19:00	2,552	402658,301	0,903	14,919	10469,785	39,997
31/08/2018 20:00	2,735	403486,705	0,899	14,859	10474,838	39,997
31/08/2018 21:00	3,12	403458,61	0,907	14,806	10480,259	39,997
31/08/2018 22:00	3,328	403781,034	0,909	14,794	10492,792	39,997
31/08/2018 23:00	4,376	404656,831	0,917	14,733	10492,95	39,999
01/09/2018 00:00	11,588	397708,353	0,905	14,19	10358,332	39,261
01/09/2018 01:00	70,78	375832,903	0,966	10,668	9481,713	35,003
01/09/2018 02:00	71,628	375830,835	0,965	10,611	9482,977	34,997
01/09/2018 03:00	83,986	377155,917	0,985	10,644	9484,439	35,004
01/09/2018 04:00	59,411	385684,843	0,979	10,735	9759,915	36,445
01/09/2018 05:00	44,446	388931,235	0,964	10,679	9886,059	36,994
01/09/2018 06:00	45,282	388526,402	0,915	10,744	9887,861	37,004
01/09/2018 07:00	41,255	388478,301	0,966	10,72	9883,339	37
01/09/2018 08:00	40,302	388615,491	0,959	10,899	9881,675	36,998
01/09/2018 09:00	35,855	388532,407	0,937	10,955	9887,269	36,997
01/09/2018 10:00	4,726	424010,215	0,876	17,253	11327,906	43,998
01/09/2018 11:00	13,037	408023,779	0,906	15,371	10905,091	42,177
01/09/2018 12:00	16,165	383610,495	0,956	11,55	9869,015	37,003
01/09/2018 13:00	14,142	383777,267	0,959	11,672	9864,288	36,999
01/09/2018 14:00	14,032	384359,965	0,867	11,696	9841,004	37
01/09/2018 15:00	12,794	384668,719	0,857	11,81	9826,843	37,001
01/09/2018 16:00	12,086	385128,398	0,864	11,903	9825,189	36,999
01/09/2018 17:00	12,031	385155,831	0,858	11,906	9841,147	37,001
01/09/2018 18:00	15,485	385034,859	0,863	11,579	9860,015	37
01/09/2018 19:00	18,462	385159,617	0,865	11,457	9879,407	37
01/09/2018 20:00	17,332	385215,267	0,876	11,545	9891,598	37,003
01/09/2018 21:00	20,111	385851,448	0,897	11,328	9897,996	37,001
01/09/2018 22:00	23,535	386444,24	0,921	11,035	9897,672	37,002
01/09/2018 23:00	24,719	386286,031	0,919	11,045	9893,675	36,998
02/09/2018 00:00	17,909	394635,228	0,903	12,633	10141,102	38,235
02/09/2018 01:00	4,249	402325,457	0,903	15,113	10506,298	39,999
02/09/2018 02:00	3,782	402363,045	0,898	15,269	10509,763	39,997
02/09/2018 03:00	4,566	402692,2	0,887	15,076	10504,415	40,001
02/09/2018 04:00	2,896	402065,098	0,89	15,62	10510,114	40,002
02/09/2018 05:00	3,246	401982,945	0,882	15,651	10508,283	40,005
02/09/2018 06:00	5,643	403310,965	0,864	15,233	10498,996	40,001
02/09/2018 07:00	5,237	403518,676	0,871	15,274	10501,428	39,999
02/09/2018 08:00	8,314	404633,775	0,884	13,786	10491,089	40,002
02/09/2018 09:00	9,006	403651,723	1,011	13,433	10464,506	39,998
02/09/2018 10:00	3,304	400660,89	0,843	14,455	10445,151	39,997
02/09/2018 11:00	14,919	400446,472	0,856	15,471	10425,902	40,001
02/09/2018 12:00	24,462	401026,56	0,876	15,631	10406,504	39,997
02/09/2018 13:00	19,181	403852,317	0,865	16,048	10480,002	40,426
02/09/2018 14:00	2,376	428406,978	0,816	18,228	11380,366	44,975
02/09/2018 15:00	2,281	428482,833	0,814	17,918	11381,627	44,986
02/09/2018 16:00	2,316	429201,879	0,813	18,031	11378,849	45,001
02/09/2018 17:00	2,242	429083,809	0,802	18,478	11703,342	46,719
02/09/2018 18:00	2,099	429018,374	0,785	18,131	12038,85	47,996
02/09/2018 19:00	2,101	429116,542	0,808	18,205	12071,478	48,002
02/09/2018 20:00	2,065	429271,939	0,817	18,407	12080,048	47,981
02/09/2018 21:00	2,169	429418,103	0,829	18,218	12094,376	47,998
02/09/2018 22:00	2,089	429454,33	0,827	18,622	12093,118	47,968
02/09/2018 23:00	2,059	428915,848	0,825	18,647	12089,685	47,966
03/09/2018 00:00	2,147	424851,512	0,824	18,594	12090,691	47,998
03/09/2018 01:00	2,151	425893,293	0,805	18,693	12097,457	47,989
03/09/2018 02:00	2,295	426090,416	0,819	19,332	12104,059	47,989
03/09/2018 03:00	2,238	426639,904	0,813	19,601	12110,352	47,996
03/09/2018 04:00	2,25	426494,393	0,815	18,718	12105,084	48,002
03/09/2018 05:00	2,33	426707,302	0,814	18,579	12078,48	47,997
03/09/2018 06:00	2,26	427500,333	0,785	18,739	12103,726	48,005
03/09/2018 07:00	2,285	428048,648	0,795	18,368	12112,701	48,002
03/09/2018 08:00	2,372	428102,434	0,8	16,468	12103,772	48
03/09/2018 09:00	2,238	428030,037	0,86	17,18	12085,891	48
03/09/2018 10:00	2,166	427594,834	0,78	17,959	12055,211	47,999
03/09/2018 11:00	2,171	427487,881	0,79	18,028	12023,88	47,926
03/09/2018 12:00	2,19	427180,741	0,791	18,122	12026,535	48
03/09/2018 13:00	2,124	427883,613	0,81	15,656	11937,294	47,875
03/09/2018 14:00	2,103	428827,858	1,167	15,458	11968,359	48,002
03/09/2018 15:00	2,038	429583,964	0,727	16,027	11917,62	47,932
03/09/2018 16:00	2,003	429550,312	0,734	16,001	11942,734	47,997
03/09/2018 17:00	2,141	430261,114	0,73	17,056	11476,224	45,617
03/09/2018 18:00	18,573	384087,753	0,779	12,997	9869,839	37,34
03/09/2018 19:00	26,896	371694,978	0,807	10,598	9436,905	34,999
03/09/2018 20:00	5,182	397174,808	0,78	20,027	10444,846	39,946
03/09/2018 21:00	16,1	403535,301	0,787	17,417	10433,662	40,001
03/09/2018 22:00	3,816	403648,077	0,779	20,439	10732,119	41,423
03/09/2018 23:00	2,16	428864,181	0,748	18,355	12069,826	47,996
04/09/2018 00:00	2,294	426578,785	0,739	18,316	12078,322	47,997
04/09/2018 01:00	2,402	427291,523	0,747	18,378	12089,172	47,998
04/09/2018 02:00	2,297	428258,786	0,742	18,354	12088,708	48,002
04/09/2018 03:00	2,365	428914,372	0,743	18,315	12088,507	47,999
04/09/2018 04:00	2,242	429418,54	0,737	18,284	12089,348	48,001
04/09/2018 05:00	2,352	429698,021	0,742	18,269	12055,821	48,001
04/09/2018 06:00	2,626	430249,983	0,722	18,807	11945,086	47,381
04/09/2018 07:00	3,82	431064,792	0,756	20,009	11469,187	45,002
04/09/2018 08:00	2,336	430577,751	0,752	17,338	11451,551	44,991

04/09/2018 09:00	2,297	429874,492	0,804	16,247	11428,558	44,999
04/09/2018 10:00	2,28	429839,281	0,737	16,612	11395,536	44,998
04/09/2018 11:00	2,313	428783,976	0,741	16,123	11370,7	44,946
04/09/2018 12:00	2,278	424998,598	0,736	16,623	11300,719	44,669
04/09/2018 13:00	2,241	427565,619	0,754	16,44	11355,411	45,001
04/09/2018 14:00	2,168	425376,914	0,738	16,217	11271,959	44,652
04/09/2018 15:00	2,221	421829,445	0,724	15,536	11110,119	43,922
04/09/2018 16:00	2,206	422589,192	0,711	15,717	11100,032	43,895
04/09/2018 17:00	2,381	426311,716	0,707	16,514	11163,136	43,999
04/09/2018 18:00	2,532	427711,574	0,692	17,254	11205,339	44,002
04/09/2018 19:00	2,96	428789,101	0,689	19,031	11241,885	44,001
04/09/2018 20:00	3,839	429142,79	0,701	19,175	11255,069	44
04/09/2018 21:00	2,875	428739,847	0,691	18,507	11269,062	44,003
04/09/2018 22:00	2,179	429337,219	0,69	18,774	11367,124	44,542
04/09/2018 23:00	2,521	430543,518	0,693	19,951	11831,193	46,718
05/09/2018 00:00	3,622	425847,846	0,708	21,347	11473,083	45
05/09/2018 01:00	2,295	275407,316	0,09	17,896	11148,38	43,32
05/09/2018 02:00	20,088	344623,448	0,409	13,828	10255,029	38,706
05/09/2018 03:00	38,581	380361,189	0,761	11,067	9681,499	36
05/09/2018 04:00	46,409	380878,699	0,767	10,894	9676,899	36,002
05/09/2018 05:00	46,255	380859,643	0,738	10,82	9657,228	36,004
05/09/2018 06:00	44,703	386333,613	0,729	11,369	9788,926	36,628
05/09/2018 07:00	5,082	404937,497	0,717	14,693	10486,478	39,998
05/09/2018 08:00	4,662	404316,139	0,742	14,724	10486,053	40
05/09/2018 09:00	4,079	403571,263	9,951	14,719	10483,245	39,998
05/09/2018 10:00	3,487	403168,164	0,727	14,663	10478,601	40,001
05/09/2018 11:00	3,024	402903,943	0,741	14,742	10464,768	40
05/09/2018 12:00	2,494	399938,826	0,742	15,492	10454,308	40
05/09/2018 13:00	2,364	399240,779	0,713	15,796	10449,919	40,002
05/09/2018 14:00	2,361	400724,419	0,94	15,22	10428,079	40,001
05/09/2018 15:00	2,298	401278,039	0,854	15,786	10426,469	40,001
05/09/2018 16:00	2,291	401380,82	0,837	15,798	10434,672	39,996
05/09/2018 17:00	2,272	400735,906	0,845	16,044	10450,163	40,001
05/09/2018 18:00	2,317	401094,136	0,858	15,707	10464,954	40,001
05/09/2018 19:00	2,448	401507,671	0,853	15,341	10478,248	39,998
05/09/2018 20:00	2,698	401778,563	0,848	15,127	10487,61	40,002
05/09/2018 21:00	2,665	402257,183	0,852	15,056	10494,651	40,001
05/09/2018 22:00	2,711	402654,706	0,871	14,956	10494,969	40,004
05/09/2018 23:00	3,468	403494,533	0,887	14,945	10491,266	39,997
06/09/2018 00:00	3,755	404073,706	0,856	14,949	10494,312	40,001
06/09/2018 01:00	4,427	404694,327	0,878	15,049	10495,35	39,999
06/09/2018 02:00	4,844	404834,968	0,879	15,19	10496,033	40,003
06/09/2018 03:00	4,65	404985,641	0,877	15,135	10499,065	40,003
06/09/2018 04:00	4,929	405469,562	0,89	15,264	10493,96	40,002
06/09/2018 05:00	5,048	405216,853	0,889	15,397	10471,037	39,995
06/09/2018 06:00	7,496	405692,335	0,856	14,804	10488,036	40,005
06/09/2018 07:00	6,866	405566,241	0,88	15,094	10500,742	39,998
06/09/2018 08:00	9,818	406360,365	0,877	13,886	10488,556	40
06/09/2018 09:00	5,646	404382,857	0,972	14,13	10482,023	39,998
06/09/2018 10:00	2,838	401990,108	0,86	14,779	10465,958	39,999
06/09/2018 11:00	2,526	399766,835	0,865	15,162	10452,114	40,001
06/09/2018 12:00	2,395	397770,588	0,871	15,3	10443,329	40
06/09/2018 13:00	2,316	398371,419	0,865	15,224	10435,07	40,001
06/09/2018 14:00	2,266	395775,71	0,85	15,533	10392,36	39,756
06/09/2018 15:00	2,309	384446,947	0,828	16,761	10083,706	38,234
06/09/2018 16:00	2,307	386234,961	0,827	16,654	10092,894	38,344
06/09/2018 17:00	2,255	398262,609	0,816	15,937	10379,556	39,765
06/09/2018 18:00	2,335	400872,404	0,816	15,444	10445,987	39,999
06/09/2018 19:00	2,379	401495,288	0,833	15,356	10463,851	40
06/09/2018 20:00	2,542	401737,284	0,841	15,202	10474,942	39,999
06/09/2018 21:00	2,497	402249,111	0,86	15,074	10482,917	40,001
06/09/2018 22:00	2,548	402244,76	0,861	15,107	10484,566	39,999
06/09/2018 23:00	2,734	402848,499	0,856	14,976	10478,796	39,996
07/09/2018 00:00	3,047	403185,871	0,85	15,066	10483,617	39,999
07/09/2018 01:00	3,177	403570,399	0,849	15,068	10489,252	40,004
07/09/2018 02:00	3,384	403570,886	0,853	15,033	10487,938	39,995
07/09/2018 03:00	3,579	403417,766	0,856	15,13	10499,909	40,004
07/09/2018 04:00	3,34	403626,204	0,84	15,164	10500,666	40,002
07/09/2018 05:00	3,628	403234,246	0,85	15,183	10483,957	40,001
07/09/2018 06:00	2,741	402634,852	0,819	15,544	10512,378	40,001
07/09/2018 07:00	2,817	415403,63	0,843	17,134	10955,756	42,242
07/09/2018 08:00	2,18	430244,37	0,821	19,225	12474,167	49,959
07/09/2018 09:00	2,152	429975,762	0,921	18,813	12466,788	49,996
07/09/2018 10:00	2,118	430427,686	0,791	17,192	12418,532	49,999
07/09/2018 11:00	2,125	430607,686	0,788	17,854	12392,897	49,997
07/09/2018 12:00	2,065	430600,33	0,782	17,808	12374,767	50,001
07/09/2018 13:00	2,02	430939,294	0,776	17,919	12347,424	50
07/09/2018 14:00	2,048	431432,631	1,19	19,038	12259,493	49,582
07/09/2018 15:00	2,064	432018,708	0,801	19,374	12167,968	49,142
07/09/2018 16:00	2,058	431694,942	0,804	19,267	12145,139	49,177
07/09/2018 17:00	2,024	431922,069	0,798	18,001	12295,639	50,001
07/09/2018 18:00	2,038	432251,407	0,799	18,021	12329,049	49,999
07/09/2018 19:00	2,105	431974,523	0,802	18,283	12267,458	50
07/09/2018 20:00	2,126	431841,076	0,805	17,735	12258,224	50,001
07/09/2018 21:00	2,081	430966,666	0,814	17,664	12268,823	50
07/09/2018 22:00	2,107	430385,944	0,824	17,135	12286,042	50,008
07/09/2018 23:00	2,085	429915,928	0,819	16,676	12293,354	50,001
08/09/2018 00:00	2,252	429163,22	0,817	18,357	12307,432	50,003
08/09/2018 01:00	2,405	419567,853	0,837	18,277	11169,542	44,1
08/09/2018 02:00	2,3	416862,297	0,85	18,296	10865,263	42,61
08/09/2018 03:00	2,37	418483,55	0,864	18,552	10875,738	42,791
08/09/2018 04:00	2,404	422348,203	0,854	18,793	10970,887	43,247
08/09/2018 05:00	2,444	420804,193	0,861	18,951	10920,213	42,99
08/09/2018 06:00	2,389	421380,818	0,829	19,177	10899,197	42,999
08/09/2018 07:00	2,41	421350,482	0,86	19,425	10877,938	43,002
08/09/2018 08:00	2,422	416296,048	0,844	18,631	10782,413	42,354
08/09/2018 09:00	2,393	405698,153	0,791	17,583	10566,377	41,124
08/09/2018 10:00	2,424	396951,566	0,857	17,312	10345,009	40,009
08/09/2018 11:00	2,412	387009,829	0,844	17,124	10131,27	38,904
08/09/2018 12:00	2,431	376618,621	0,86	17,461	9854,341	37,622
08/09/2018 13:00	2,413	371889,868	0,869	17,631	9663,159	36,838
08/09/2018 14:00	2,385	369263,229	1,187	17,781	9572,655	36,385

08/09/2018 15:00	2,397	368806,918	0,818	17,735	9532,537	36,154
08/09/2018 16:00	2,398	368126,291	0,819	17,647	9519,758	36,03
08/09/2018 17:00	2,402	370621,683	0,811	17,852	9544,052	36,245
08/09/2018 18:00	2,425	378001,421	0,802	18,234	9814,224	37,139
08/09/2018 19:00	2,43	386381,576	0,797	18,321	10066,76	38,448
08/09/2018 20:00	2,322	401852,931	0,826	17,799	10435,741	40,49
08/09/2018 21:00	2,951	423795,391	0,825	20,025	10897,292	42,957
08/09/2018 22:00	3,151	424610,445	0,839	20,095	10914,756	43,005
08/09/2018 23:00	3,274	424448,576	0,826	20,29	10915,429	42,996
09/09/2018 00:00	3,75	424049,13	0,818	20,297	10914,437	42,997
09/09/2018 01:00	4,662	425107,132	0,833	20,142	10913,725	42,999
09/09/2018 02:00	4,962	425303,416	0,829	19,982	10904,236	42,998
09/09/2018 03:00	4,469	422884,896	0,826	20,228	10899,502	42,842
09/09/2018 04:00	2,49	410637,294	0,823	18,486	10699,519	41,748
09/09/2018 05:00	2,721	420545,19	0,834	20,452	10980,841	43,266
09/09/2018 06:00	2,377	431304,86	0,792	22,438	11302,471	44,998
09/09/2018 07:00	2,746	431687,627	0,805	22,046	11297,569	45,002
09/09/2018 08:00	3,043	431079,26	0,806	20,503	11291,561	44,998
09/09/2018 09:00	2,318	430759,7	0,76	18,975	11274,26	44,955
09/09/2018 10:00	2,66	431729,785	0,803	19,577	11257,077	45,001
09/09/2018 11:00	2,441	430804,299	0,792	19,339	11248,093	44,995
09/09/2018 12:00	2,37	430626,911	0,789	19,005	11245,72	45
09/09/2018 13:00	2,286	430997,853	0,788	18,065	11243,319	44,999
09/09/2018 14:00	2,263	430194,493	0,8	17,895	11229,625	45,005
09/09/2018 15:00	2,205	429991,788	0,814	17,351	11216,375	44,999
09/09/2018 16:00	2,16	430065,885	0,804	16,732	11236,642	44,998
09/09/2018 17:00	2,158	430115,666	0,794	16,224	11274,894	44,999
09/09/2018 18:00	2,18	431006,607	0,792	16,235	11293,074	45
09/09/2018 19:00	2,321	431253,156	0,813	17,187	11314,636	44,998
09/09/2018 20:00	2,282	431602,194	0,833	18,689	11316,946	45,001
09/09/2018 21:00	2,438	431429,761	0,841	19,231	11317,892	45,002
09/09/2018 22:00	2,735	431390,056	0,834	20,306	11326,07	45,004
09/09/2018 23:00	2,785	431162,31	0,842	20,272	11325,204	44,994
10/09/2018 00:00	2,989	430454,037	0,832	20,612	11323,212	44,999
10/09/2018 01:00	2,658	430270,813	0,854	20,739	11319,593	45
10/09/2018 02:00	2,64	430048,917	0,84	19,947	11317,066	44,999
10/09/2018 03:00	2,561	430015,857	0,829	18,937	11325,872	45,002
10/09/2018 04:00	2,601	430320,16	0,83	21,269	11312,341	44,991
10/09/2018 05:00	2,524	430737,411	0,826	20,376	11298,05	44,997
10/09/2018 06:00	2,402	429910,559	0,8	19,555	11322,93	44,997
10/09/2018 07:00	2,692	429345,487	0,825	21,259	11321,36	44,999
10/09/2018 08:00	2,793	429052,741	0,811	19,494	11312,386	44,99
10/09/2018 09:00	2,31	428572,898	0,738	16,461	11295,504	44,987
10/09/2018 10:00	2,306	428856,067	0,807	16,708	11273,058	44,999
10/09/2018 11:00	2,261	428335,685	0,81	17,118	11247,4	44,923
10/09/2018 12:00	2,248	428963,134	0,811	17,537	11248,153	45
10/09/2018 13:00	2,205	427568,983	0,823	17,602	11196,36	44,877
10/09/2018 14:00	2,143	429409,602	0,817	16,765	11198,209	44,973
10/09/2018 15:00	2,137	430402,976	0,783	17,107	11200,126	45
10/09/2018 16:00	2,165	428524,574	0,775	17,127	11176,967	44,87
10/09/2018 17:00	2,16	430612,29	0,764	16,34	11215,63	45
10/09/2018 18:00	2,182	430704,876	0,76	16,246	11256,105	44,998
10/09/2018 19:00	2,241	431268,645	0,764	16,103	11292,123	45,003
10/09/2018 20:00	2,28	431584,09	0,786	16,284	11307,544	45,005
10/09/2018 21:00	2,318	431753,905	0,795	18,149	11315,059	45
10/09/2018 22:00	2,41	431608,87	0,793	19,738	11306,667	44,999
10/09/2018 23:00	2,695	431038,002	0,799	20,306	11311,636	44,998
11/09/2018 00:00	2,642	428903,349	0,789	20,405	11316,703	45
11/09/2018 01:00	3,136	429235,038	0,811	21,018	11313,22	44,999
11/09/2018 02:00	3,067	428804,34	0,806	20,947	11318,666	45,002
11/09/2018 03:00	3,18	428710,528	0,792	20,988	11319,743	45
11/09/2018 04:00	3,615	428039,277	0,795	20,999	11321,324	45
11/09/2018 05:00	10,12	414083,968	0,81	18,104	10758,51	42,179
11/09/2018 06:00	28,435	380307,892	0,822	10,917	9541,313	35,999
11/09/2018 07:00	30,541	381366,361	0,849	10,936	9547,888	35,999
11/09/2018 08:00	26,868	363445,292	0,773	10,784	9536,897	36,003
11/09/2018 09:00		252733,169	1,096	12,761	9515,603	36
11/09/2018 10:00	17,276	255819,486	29,065	11,401	9496,169	35,997
11/09/2018 11:00	13,703	258504,675	65,044	11,371	9481,378	36,004
11/09/2018 12:00	13,182	258650,119	66,823	11,261	9478,403	36
11/09/2018 13:00	13,964	261761,191	66,982	11,163	9465,87	36,001
11/09/2018 14:00	12,549	262651,679	66,847	11,228	9459,386	36,003
11/09/2018 15:00	10,721	261049,748	26,579	11,381	9432,984	35,999
11/09/2018 16:00	11,465	260620,702	0,525	11,415	9472,246	35,998
11/09/2018 17:00	10,43	261987,221	0,251	11,557	9481,576	35,998
11/09/2018 18:00	17,928	264600,914	0,107	10,913	9477,468	36,003
11/09/2018 19:00	19,228	295082,72	0,074	10,926	9505,014	36,007
11/09/2018 20:00	19,82	332618,808	0,092	10,962	9528,004	35,998
11/09/2018 21:00	16,904	360925,521	0,5	11,6	9562,5	36,183
11/09/2018 22:00	5,89	384218,732	0,798	14,317	9884,998	37,439
11/09/2018 23:00	37,83	334145,915	0,264	12,745	9125,666	33,961
12/09/2018 00:00	38,441	320877,496	0,072	12,701	9158,542	34,001
12/09/2018 01:00	49,946	334356,839	0,077	12,583	9158,79	33,999
12/09/2018 02:00	50,308	336215,67	0,087	12,479	9159,427	34,003
12/09/2018 03:00	45,788	338530,806	0,087	12,495	9225,903	34,384
12/09/2018 04:00	47,254	341543,499	0,095	12,383	9256,682	34,502
12/09/2018 05:00	41,719	349849,605	0,107	12,326	9307,989	34,919
12/09/2018 06:00	40,924	364099,239	0,619	12,236	9346,276	34,998
12/09/2018 07:00	37,148	373218,876	0,81	12,307	9358,199	34,998
12/09/2018 08:00	32,853	372321,994	0,801	12,466	9344,675	34,999
12/09/2018 09:00	13,556	408942,585	0,747	17,675	10548,556	41,263
12/09/2018 10:00	2,443	429725,953	0,74	23,315	11298,166	44,998
12/09/2018 11:00	2,373	429523,409	0,748	21,027	11296,873	45,001
12/09/2018 12:00	2,35	429765,342	0,741	19,971	11305,684	44,999
12/09/2018 13:00	2,332	430064,171	0,73	19,883	11303,897	45,002
12/09/2018 14:00	2,273	430663,452	0,731	19,926	11303,198	44,999
12/09/2018 15:00	2,256	430482,736	0,907	19,705	11295,638	44,996
12/09/2018 16:00	2,26	430338,487	0,833	19,592	11284,079	44,998
12/09/2018 17:00	2,225	430205,2	0,824	19,634	11281,366	44,998
12/09/2018 18:00	2,235	429415,355	0,826	19,484	11306,484	44,998
12/09/2018 19:00	2,238	428733,123	0,82	19,554	11321,6	44,999
12/09/2018 20:00	2,352	428509,539	0,821	21,573	11329,995	45,005

12/09/2018 21:00	2,524	428359,606	0,863	21,883	11331,127	44,999
12/09/2018 22:00	2,491	428746,031	0,85	22,543	11337,346	45
12/09/2018 23:00	2,84	429731,291	0,852	22,674	11332,283	44,997
13/09/2018 00:00	3,316	418616,497	0,858	21,619	10942,523	43,076
13/09/2018 01:00	4,098	420574,302	0,883	20,941	10824,959	42,498
13/09/2018 02:00	3,935	420549,554	0,861	20,88	10834,621	42,498
13/09/2018 03:00	5,474	421900,475	0,874	20,606	10826,433	42,503
13/09/2018 04:00	9,174	423156,745	0,867	20,163	10817,461	42,501
13/09/2018 05:00	3,197	429213,347	0,834	22,51	11262,313	44,767
13/09/2018 06:00	2,389	428739,364	0,815	23,074	11328,53	44,998
13/09/2018 07:00	2,563	427275,201	0,879	22,85	11342,036	45
13/09/2018 08:00	2,505	426926,421	0,868	21,226	11338,508	45,001
13/09/2018 09:00	2,3	427387,778	0,802	19,214	11324,668	44,998
13/09/2018 10:00	2,275	428456,531	0,835	18,963	11297,197	45,001
13/09/2018 11:00	2,264	429265,047	0,819	19,584	11294,072	45
13/09/2018 12:00	2,285	429032,525	0,819	19,455	11294,29	44,999
13/09/2018 13:00	2,293	428966,695	0,817	19,329	11284,241	45
13/09/2018 14:00	3,318	428574,876	0,846	18,488	11275,246	44,998
13/09/2018 15:00	90,029	428884,946	0,699	20,17	11266,2	44,996
13/09/2018 16:00	2,209	429233,257	0,818	19,643	11271,127	44,998
13/09/2018 17:00	2,322	413978,731	0,825	20,63	10761,723	42,468
13/09/2018 18:00	2,196	429815,002	0,812	19,55	11298,448	45
13/09/2018 19:00	2,365	429419,918	0,818	20,677	11320,335	44,996
13/09/2018 20:00	2,397	429139,921	0,826	21,922	11327,675	44,999
13/09/2018 21:00	2,569	429005,532	0,82	22,734	11332,212	45,001
13/09/2018 22:00	2,701	429090,635	0,835	22,572	11334,761	45,001
13/09/2018 23:00	2,884	429261,128	0,835	22,525	11339,039	45
14/09/2018 00:00	3,116	428179,35	0,828	22,34	11331,059	44,994
14/09/2018 01:00	2,703	428557,42	0,851	22,665	11332,471	44,998
14/09/2018 02:00	2,705	428765,905	0,849	22,943	11326,859	45
14/09/2018 03:00	2,57	428865,663	0,863	23,053	11328,869	45
14/09/2018 04:00	2,589	428899,322	0,851	22,974	11329,585	44,998
14/09/2018 05:00	2,76	429258,493	0,845	23,171	11312,497	45
14/09/2018 06:00	2,636	430375,971	0,811	23,269	11331,574	44,999
14/09/2018 07:00	2,638	431591,445	0,823	23,068	11342,056	45,001
14/09/2018 08:00	2,621	430625,306	0,827	22,659	11332,043	45
14/09/2018 09:00	2,485	430653,659	0,769	20,822	11322,438	44,999
14/09/2018 10:00	2,419	430278,026	0,833	18,21	11311,169	44,998
14/09/2018 11:00	2,3	429357,412	0,829	18,248	11303,401	45,001
14/09/2018 12:00	2,26	429347,724	0,836	18,425	11300,22	45
14/09/2018 13:00	2,216	429228,223	0,821	18,162	11294,318	45,001
14/09/2018 14:00	2,253	429153,484	0,831	16,331	11264,86	45,001
14/09/2018 15:00	2,129	429301,614	0,835	14,894	11234,288	45,002
14/09/2018 16:00	2,17	429422,446	0,83	15,053	11236,68	45
14/09/2018 17:00	2,842	429358,552	0,833	15,504	11240,687	44,999
14/09/2018 18:00	4,69	429410,005	0,838	17,469	11264,528	44,998
14/09/2018 19:00	2,304	429716,365	0,827	20,616	11311,771	45,003
14/09/2018 20:00	2,401	431213,714	0,839	22,028	11311,573	45
14/09/2018 21:00	2,448	429878,856	0,847	22,544	11323,814	45,001
14/09/2018 22:00	2,472	429720,132	0,843	22,448	11325,915	45,051
14/09/2018 23:00	2,231	429751,647	0,841	21,524	11520,822	46,003
15/09/2018 00:00	2,238	430175,05	0,82	21,529	11528,944	45,999
15/09/2018 01:00	2,264	430232,917	0,837	21,262	11533,015	46
15/09/2018 02:00	2,239	430922,437	0,846	20,924	11532,982	46,001
15/09/2018 03:00	2,243	431103,883	0,845	21,06	11536,523	45,998
15/09/2018 04:00	2,333	430816,031	0,83	20,712	11534,65	46,001
15/09/2018 05:00	2,388	427442,182	0,858	18,784	11235,126	44,121
15/09/2018 06:00	3,001	429475,523	0,827	20,82	11129,405	43,955
15/09/2018 07:00	3,169	429466,222	0,856	21,329	11131,721	43,999
15/09/2018 08:00	3,354	429650,758	0,856	21,268	11128,503	44,002
15/09/2018 09:00	3,361	429561,864	0,858	21,282	11120,894	43,995
15/09/2018 10:00	3,181	429694,333	0,847	21,275	11115,293	44
15/09/2018 11:00	3,175	429714,313	0,845	21,247	11119,687	44,002
15/09/2018 12:00	3,254	429899,166	0,875	21,182	11130,075	43,997
15/09/2018 13:00	3,679	429926,874	0,897	21,115	11137,327	43,999
15/09/2018 14:00	3,607	429860,396	0,908	21,211	11141,969	43,999
15/09/2018 15:00	3,552	429676,527	0,897	21,211	11139,073	43,998
15/09/2018 16:00	3,471	430201,817	0,866	21,2	11143,28	43,997
15/09/2018 17:00	3,705	429901,801	0,876	21,17	11141,935	43,999
15/09/2018 18:00	3,956	429893,342	0,869	21,165	11139,69	43,997
15/09/2018 19:00	4,231	429804,465	0,854	21,14	11139,938	44,001
15/09/2018 20:00	4,417	429821,108	0,862	21,109	11142,064	44
15/09/2018 21:00	4,528	429735,634	0,847	21,106	11139,232	44,001
15/09/2018 22:00	3,942	429806,044	0,858	21,266	11143,176	44
15/09/2018 23:00	3,769	429926,423	0,865	21,291	11143,144	43,998
16/09/2018 00:00	3,968	428369,815	0,844	21,281	11140,991	44,006
16/09/2018 01:00	3,946	428481,636	0,869	21,198	11143,748	44,001
16/09/2018 02:00	4,145	428519,886	0,865	21,262	11143,341	43,998
16/09/2018 03:00	4,745	428626,304	0,872	21,132	11148,397	44,004
16/09/2018 04:00	7,08	428655,093	0,879	20,653	11144,798	44,002
16/09/2018 05:00	7,548	428704,808	0,88	20,672	11151,024	44,001
16/09/2018 06:00	8,225	429224,732	0,875	20,556	11151,154	44
16/09/2018 07:00	7,882	429778,461	0,904	20,716	11147,616	43,999
16/09/2018 08:00	6,824	429561,499	0,899	20,333	11140,498	43,998
16/09/2018 09:00	4,552	429693,981	0,84	20,939	11118,354	44,005
16/09/2018 10:00	2,783	429315,308	0,813	21,189	11102,545	43,999
16/09/2018 11:00	2,811	424392,936	0,807	20,557	10976,651	43,364
16/09/2018 12:00	2,725	420585,965	0,823	20,15	10886,956	43,003
16/09/2018 13:00	2,501	420094,759	0,806	19,912	10877,892	43,003
16/09/2018 14:00	2,283	417970,693	0,805	18,032	10881,543	43
16/09/2018 15:00	2,24	418357,028	0,803	17,99	10906,95	42,99
16/09/2018 16:00	2,227	419006,338	0,795	18,092	10922,623	43,001
16/09/2018 17:00	2,236	419006,655	0,799	18,334	10941,304	42,995
16/09/2018 18:00	20,644	384056,828	0,851	15,79	9782,843	37,144
16/09/2018 19:00	2,286	430843,717	0,805	21,069	11360,64	45
16/09/2018 20:00	2,39	431452,329	0,805	22,873	11348,018	45,003
16/09/2018 21:00	2,527	431890,549	0,811	22,976	11342,287	44,998
16/09/2018 22:00	2,802	432098,822	0,812	22,792	11350,659	45,001
16/09/2018 23:00	2,958	431272,449	0,818	22,618	11352,914	44,999
17/09/2018 00:00	3,143	430276,079	0,819	22,627	11346,288	44,999
17/09/2018 01:00	3,111	429648,422	0,841	22,641	11338,638	44,974
17/09/2018 02:00	3,298	429345,282	0,839	22,667	11340,22	44,999

17/09/2018 03:00	2,984	429389,435	0,83	22,724	11337,407	44,998
17/09/2018 04:00	3,211	429456,816	0,834	22,643	11329,224	44,997
17/09/2018 05:00	2,464	429623,595	0,814	22,252	11336,936	44,996
17/09/2018 06:00	2,408	430103,526	0,785	22,075	11341,136	44,999
17/09/2018 07:00	2,415	430350,139	0,822	21,348	11330,817	44,998
17/09/2018 08:00	2,33	430383,111	0,811	19,896	11318,305	45,003
17/09/2018 09:00	2,364	430213,583	1,223	18,374	11300,939	45,001
17/09/2018 10:00	2,299	430137,555	0,837	18,417	11279,59	45,001
17/09/2018 11:00	2,37	429532,149	0,837	19,49	11253,121	44,996
17/09/2018 12:00	2,352	429260,446	0,841	19,545	11236,617	44,998
17/09/2018 13:00	2,295	429813,305	0,826	19,41	11238,287	44,998
17/09/2018 14:00	2,39	430902,169	0,821	19,491	11219,877	45,001
17/09/2018 15:00	2,421	430760,274	0,856	19,704	11192,52	45
17/09/2018 16:00	2,301	430600,479	0,831	19,586	11196,516	45,001
17/09/2018 17:00	2,315	429798,025	0,833	19,278	11216,591	45,002
17/09/2018 18:00	2,473	430321,046	0,832	19,301	11224,351	44,998
17/09/2018 19:00	2,495	430911,602	0,833	20,816	11223,814	45,001
17/09/2018 20:00	2,554	430971,368	0,837	21,28	11216,509	44,999
17/09/2018 21:00	2,519	431025,763	0,835	21,438	11220,311	45,003
17/09/2018 22:00	2,597	431078,457	0,835	22,097	11228,952	44,999
17/09/2018 23:00	2,456	430994,441	0,837	22,896	11216,963	44,997
18/09/2018 00:00	2,296	427349,34	0,854	20,565	11646,457	47,108
18/09/2018 01:00	2,212	429220,125	0,924	19,742	11848,186	48,001
18/09/2018 02:00	2,133	429342,849	0,831	19,611	11856,301	48,002
18/09/2018 03:00	2,128	429508,105	0,852	19,728	11847,019	47,997
18/09/2018 04:00	2,109	429149,867	0,857	20,786	11841,922	47,998
18/09/2018 05:00	2,151	428970,409	0,85	22,385	11835,715	48,004
18/09/2018 06:00	2,149	431267,222	0,822	22,58	11821,193	48,004
18/09/2018 07:00	2,167	429846,089	0,857	21,336	11759,169	47,721
18/09/2018 08:00	2,351	430362,694	0,885	22,819	11220,441	45,002
18/09/2018 09:00	2,328	430815,927	0,771	20,963	11219,631	45
18/09/2018 10:00	2,311	430908,655	0,855	18,957	11226,864	45
18/09/2018 11:00	2,19	430780,241	0,927	19,003	11236,192	45
18/09/2018 12:00	2,18	430751,399	0,913	19,031	11245,24	44,999
18/09/2018 13:00	2,188	430523,093	0,923	18,819	11244,211	45,002
18/09/2018 14:00	2,181	429703,394	0,921	18,707	11243,772	44,997
18/09/2018 15:00	2,2	429600,644	0,929	20,399	11242,604	45,001
18/09/2018 16:00	2,193	429280,619	0,889	20,143	11243,678	45,001
18/09/2018 17:00	2,184	429133,754	0,847	19,721	11232,123	45,003
18/09/2018 18:00	2,262	429809,882	0,846	20,294	11231,197	45,003
18/09/2018 19:00	2,301	429643,351	0,879	21,192	11236,117	45,005
18/09/2018 20:00	2,356	429809,416	0,876	22,426	11241,417	45,003
18/09/2018 21:00	2,386	429651,29	0,877	23,094	11248,484	44,998
18/09/2018 22:00	2,369	429796,08	0,886	23,067	11247,329	44,998
18/09/2018 23:00	2,422	429841,818	0,891	23,132	11242,403	44,998
19/09/2018 00:00	2,415	425766,922	0,899	23,163	11239,042	44,999
19/09/2018 01:00	2,379	427587,669	0,893	23,221	11242,858	45,001
19/09/2018 02:00	2,72	427524,812	0,881	23,126	11246,544	45,003
19/09/2018 03:00	3,05	427668,244	0,885	23,181	11238,378	45,001
19/09/2018 04:00	2,876	427349,821	0,891	23,212	11241,799	44,998
19/09/2018 05:00	2,449	427347,296	0,918	23,357	11247,389	45
19/09/2018 06:00	2,475	430270,877	0,871	23,502	11258,906	44,999
19/09/2018 07:00	2,969	429909,631	0,872	23,34	11254,797	44,999
19/09/2018 08:00	2,592	429477,725	0,889	23,487	11249,455	44,997
19/09/2018 09:00	2,489	429624,322	0,773	22,457	11397,076	45,867
19/09/2018 10:00	2,334	429687,158	0,858	20,428	11435,575	46,001
19/09/2018 11:00	2,278	429714,443	0,856	19,75	11432,825	46,005
19/09/2018 12:00	2,365	429856,114	0,853	19,293	11426,22	46,002
19/09/2018 13:00	2,289	429586,615	0,863	20,459	11435,31	45,997
19/09/2018 14:00	2,294	429784,811	0,858	19,522	11440,923	45,997
19/09/2018 15:00	2,312	429620,598	0,87	19,434	11441,333	46
19/09/2018 16:00	2,356	429679,488	0,852	19,577	11441,756	46,003
19/09/2018 17:00	2,285	429413,741	0,863	19,391	11451,806	45,999
19/09/2018 18:00	2,374	429257,364	0,851	20,484	11451,815	46,001
19/09/2018 19:00	2,371	429362,334	0,85	20,588	11457,616	46
19/09/2018 20:00	2,45	429254,477	0,87	21,499	11453,678	46,002
19/09/2018 21:00	2,624	429689,206	0,86	22,28	11455,209	46,002
19/09/2018 22:00	2,479	429598,586	0,882	22,178	11458,196	45,996
19/09/2018 23:00	2,34	428751,256	0,891	21,468	11458,013	45,999
20/09/2018 00:00	7,646	408994,456	0,891	20,03	10711,768	42,203
20/09/2018 01:00	14,74	406081,802	0,927	19,127	10259,769	40,001
20/09/2018 02:00	10,092	405375,749	0,922	19,544	10261,141	39,999
20/09/2018 03:00	13,651	405957,165	0,918	19,208	10259,335	39,997
20/09/2018 04:00	15,161	405851,274	0,914	19,005	10255,741	39,997
20/09/2018 05:00	19,277	406735,166	0,904	18,517	10248,627	40,003
20/09/2018 06:00	18,164	407121,348	0,898	18,572	10256,633	40,001
20/09/2018 07:00	17,187	405162,756	0,947	19,046	10252,094	39,997
20/09/2018 08:00	16,744	405503,899	0,923	19,103	10248,529	40
20/09/2018 09:00	9,962	413046,437	0,816	20,154	10626,295	41,796
20/09/2018 10:00	2,576	429046,172	0,841	22,572	11244,552	44,998
20/09/2018 11:00	2,41	429140,476	0,83	22,483	11235,838	45,002
20/09/2018 12:00	2,296	429389,914	0,847	19,655	11237,487	44,998
20/09/2018 13:00	2,29	429179,357	0,845	19,03	11241,801	45
20/09/2018 14:00	2,335	429108,352	0,825	19,413	11245,134	44,998
20/09/2018 15:00	2,366	428916,736	0,834	18,966	11255,418	45
20/09/2018 16:00	2,356	428907,737	0,829	19,192	11256,196	45,003
20/09/2018 17:00	2,367	429011,588	0,827	19,18	11254,79	45,001
20/09/2018 18:00	2,494	428859,22	0,828	19,245	11248,078	44,999
20/09/2018 19:00	2,566	428716,758	0,836	19,582	11255,813	45,002
20/09/2018 20:00	2,634	428701,806	0,852	20,229	11262,952	44,997
20/09/2018 21:00	2,556	428261,934	0,849	19,737	11277,777	44,998
20/09/2018 22:00	2,318	428814,027	0,85	19,816	11271,648	44,998
20/09/2018 23:00	2,434	428820,547	0,863	20,143	11267,845	45
21/09/2018 00:00	2,353	427204,411	0,85	21,407	11260,713	44,999
21/09/2018 01:00	2,275	428937,737	0,859	22,262	11257,261	45
21/09/2018 02:00	2,248	429391,728	0,859	22,652	11255,552	45
21/09/2018 03:00	2,271	429942,162	0,853	23,191	11252,103	44,995
21/09/2018 04:00	2,355	429588,369	0,856	23,36	11251,855	44,997
21/09/2018 05:00	2,215	430128,272	0,847	21,043	11244,211	45
21/09/2018 06:00	2,347	430072,383	0,816	21,51	11245,673	44,997
21/09/2018 07:00	2,43	429930,305	0,854	22,273	11254,153	44,999
21/09/2018 08:00	2,565	429745,967	0,839	20,009	11252,701	44,999

21/09/2018 09:00	2,394	429425,918	0,735	19,95	11233,878	45,003
21/09/2018 10:00	2,424	429099,318	1,307	19,154	11212,515	45,003
21/09/2018 11:00	2,304	427748,234	0,816	17,794	11206,338	45,003
21/09/2018 12:00	2,311	426246,744	0,814	18,027	11197,003	44,999
21/09/2018 13:00	2,288	425998,981	0,815	17,947	11200,364	45,001
21/09/2018 14:00	2,237	426670,207	0,818	17,975	11181,482	45
21/09/2018 15:00	2,267	408925,182	0,832	16,616	10657,505	42,322
21/09/2018 16:00	2,384	381366,791	0,856	13,993	9848,246	38,19
21/09/2018 17:00	2,456	366790,217	0,858	16,054	9475,699	36,07
21/09/2018 18:00	2,45	374655,116	0,85	16,945	9683,935	36,869
21/09/2018 19:00	2,426	382781,548	0,846	16,641	9885,824	37,989
21/09/2018 20:00	2,377	389489,112	0,824	16,935	10063,305	38,951
21/09/2018 21:00	2,414	393400,221	0,825	16,9	10177,4	39,462
21/09/2018 22:00	2,398	397556,518	0,823	17,044	10289,629	40,042
21/09/2018 23:00	2,325	400500,57	0,855	16,808	10363,989	40,383
22/09/2018 00:00	2,43	406666,184	0,845	17,185	10571,114	41,459
22/09/2018 01:00	2,541	406434,394	0,836	17,083	10535,837	41,212
22/09/2018 02:00	2,478	409738,523	0,848	17,353	10598,66	41,642
22/09/2018 03:00	2,44	411294,995	0,847	17,428	10650,551	41,842
22/09/2018 04:00	2,464	412223,153	0,856	17,45	10672,689	41,928
22/09/2018 05:00	2,509	413504,76	0,857	17,486	10695,934	42,063
22/09/2018 06:00	2,524	418081,974	0,818	17,77	10773,826	42,448
22/09/2018 07:00	2,414	416616,35	0,839	17,906	10777,848	42,454
22/09/2018 08:00	2,352	411055,115	0,845	17,466	10623,628	41,707
22/09/2018 09:00	2,355	408081,983	0,733	17,101	10517,192	41,283
22/09/2018 10:00	2,336	401924,976	0,846	16,833	10380,94	40,649
22/09/2018 11:00	2,295	422208,768	0,848	18,799	10961,454	43,812
22/09/2018 12:00	2,261	429937,447	0,857	19,206	11242,293	45,243
22/09/2018 13:00	2,176	430566,537	0,852	17,454	11403,183	46,001
22/09/2018 14:00	2,145	430773,864	0,845	16,38	11390,973	45,998
22/09/2018 15:00	2,141	431114,835	0,855	15,96	11368,041	45,894
22/09/2018 16:00	2,154	431218,389	0,857	16,769	11382,016	45,896
22/09/2018 17:00	2,2	431270,469	0,848	18,88	11390,136	45,781
22/09/2018 18:00	2,206	431263,338	0,856	18,229	11238,104	45,002
22/09/2018 19:00	2,252	431212,465	0,863	20,18	11243,171	45,002
22/09/2018 20:00	2,324	431163,837	0,855	21,496	11252,411	45,001
22/09/2018 21:00	2,47	430937,707	0,862	22,256	11252,901	45
22/09/2018 22:00	3,173	431111,576	0,876	20,081	11248,01	45,001
22/09/2018 23:00	3,717	431737,766	0,892	18,559	11236,544	44,996
23/09/2018 00:00	160,655	351654,077	0,949	14,476	8707,484	31,721
23/09/2018 01:00	197,818	346544,042	0,999	13,412	8373,791	30,002
23/09/2018 02:00	204,97	347753,433	0,987	13,278	8374,609	29,999
23/09/2018 03:00	202,771	347409,447	0,988	13,226	8374,918	29,998
23/09/2018 04:00	205,802	347183,756	1	13,091	8376,506	30,001
23/09/2018 05:00	210,859	347669,264	0,982	13,039	8372,695	30,004
23/09/2018 06:00	84,855	367399,38	0,945	12,111	9099,163	33,903
23/09/2018 07:00	37,475	373231,7	0,957	11,459	9296,589	35,002
23/09/2018 08:00	37,052	373005,083	0,964	11,443	9293,526	35,002
23/09/2018 09:00	35,84	372932,997	0,848	11,433	9287,647	35
23/09/2018 10:00	28,105	372734,63	0,896	11,56	9266,198	34,999
23/09/2018 11:00	10,507	369065,92	0,89	12,142	9257,464	35,003
23/09/2018 12:00	13,3	365080,553	0,9	12,427	9159,715	34,508
23/09/2018 13:00	35,769	354695,442	0,911	12,671	8769,882	32,5
23/09/2018 14:00	22,679	354211,533	0,914	13,104	8762,869	32,502
23/09/2018 15:00	15,621	355943,703	0,902	13,545	8844,787	32,898
23/09/2018 16:00	13,579	354462,639	0,913	13,403	8746,916	32,497
23/09/2018 17:00	14,79	357910,853	0,907	13,796	8861,82	33,047
23/09/2018 18:00	2,453	404390,408	0,861	20,723	10410,516	40,853
23/09/2018 19:00	2,73	400392,085	0,865	20,684	10261,035	39,998
23/09/2018 20:00	3,813	401344,789	0,894	19,929	10267,818	40
23/09/2018 21:00	6,519	402607,623	0,899	19,513	10266,313	40,003
23/09/2018 22:00	8,746	403793,782	0,884	19,254	10267,735	39,999
23/09/2018 23:00	10,411	403855,247	0,911	19,251	10259,717	39,999
24/09/2018 00:00	12,638	403486,026	0,884	19,086	10255,467	39,998
24/09/2018 01:00	15,573	405636,143	0,888	18,961	10254,441	39,997
24/09/2018 02:00	17,669	388422,524	0,906	15,368	9814,303	37,511
24/09/2018 03:00	40,809	370012,329	0,94	12,517	9164,783	34,435
24/09/2018 04:00	2,364	430202,393	0,866	20,282	11225,256	44,874
24/09/2018 05:00	2,393	431804,901	0,861	21,421	11239,676	45,004
24/09/2018 06:00	2,542	431536,065	0,823	21,82	11198,893	44,622
24/09/2018 07:00	3,013	424911,752	0,872	21,693	10854,031	43
24/09/2018 08:00	2,649	423884,768	0,863	21,629	10849,367	42,999
24/09/2018 09:00	2,635	423326,388	0,767	21,665	10844,502	43,001
24/09/2018 10:00	2,511	421614,641	0,833	20,927	10840,369	42,998
24/09/2018 11:00	2,412	408469,441	0,805	17,396	10583,066	41,493
24/09/2018 12:00	2,389	417762,135	0,797	17,797	10761,379	42,596
24/09/2018 13:00	2,358	420836,407	0,797	18,233	10828,314	42,997
24/09/2018 14:00	2,362	419601,814	0,794	18,026	10834,126	42,999
24/09/2018 15:00	2,355	419345,657	0,788	18,023	10842,175	42,998
24/09/2018 16:00	2,382	419815,573	0,799	18,045	10841,857	43,002
24/09/2018 17:00	2,395	419525,405	0,799	17,934	10845,088	43,004
24/09/2018 18:00	2,386	419566,043	0,794	17,775	10846,172	43,001
24/09/2018 19:00	2,49	419490,886	0,8	17,895	10863,851	43
24/09/2018 20:00	2,561	413128,577	0,815	17,491	10719,176	42,09
24/09/2018 21:00	2,562	415005,187	0,835	19,284	10708,45	42,213
24/09/2018 22:00	2,708	409754,613	0,82	17,506	10637,503	41,612
24/09/2018 23:00	2,488	406307,265	0,834	16,787	10525,712	41,148
25/09/2018 00:00	2,556	407502,067	0,819	16,873	10584,455	41,469
25/09/2018 01:00	2,598	411227,968	0,827	17,123	10648,528	41,779
25/09/2018 02:00	2,489	410764,051	0,834	17,273	10631,705	41,723
25/09/2018 03:00	2,473	412828,608	0,828	17,498	10678,762	41,983
25/09/2018 04:00	2,497	414201,707	0,824	17,47	10723,961	42,204
25/09/2018 05:00	2,483	416688,814	0,823	17,691	10770,117	42,508
25/09/2018 06:00	2,488	415064,887	0,793	17,671	10711,142	42,114
25/09/2018 07:00	2,508	412046,53	0,832	17,427	10677,156	41,924
25/09/2018 08:00	2,585	411857,098	0,826	17,378	10661,37	41,86
25/09/2018 09:00	2,578	413188,452	0,736	18,096	10647,278	41,951
25/09/2018 10:00	2,552	421475,338	0,819	18,938	10840,524	42,998
25/09/2018 11:00	2,572	419664,599	0,788	18,107	10837,787	42,998
25/09/2018 12:00	2,446	420299,253	0,78	16,647	10810,923	42,995
25/09/2018 13:00	2,397	420918,618	0,769	15,716	10799,947	43,002
25/09/2018 14:00	2,365	420666,694	0,779	15,602	10802,726	42,998

25/09/2018 15:00	2,41	421001,501	0,801	16,011	10808,334	43,002
25/09/2018 16:00	2,481	405130,027	0,784	16,776	10430,816	40,885
25/09/2018 17:00	2,476	386256,28	0,781	16,32	9934,849	38,226
25/09/2018 18:00	2,511	386037,091	0,794	15,87	9869,496	38
25/09/2018 19:00	2,557	386030,383	0,809	15,754	9888,275	38,002
25/09/2018 20:00	2,625	394663,043	0,814	16,945	10187,791	39,442
25/09/2018 21:00	2,656	395868,399	0,818	16,928	10203,157	39,502
25/09/2018 22:00	2,714	395953,21	0,805	16,714	10191,526	39,501
25/09/2018 23:00	2,591	396036,593	0,822	16,683	10189,494	39,501
26/09/2018 00:00	2,629	395189,829	0,805	16,445	10178,835	39,503
26/09/2018 01:00	2,592	398368,47	0,814	17,225	10265,027	39,976
26/09/2018 02:00	2,575	399031,724	0,815	16,738	10276,724	39,996
26/09/2018 03:00	2,609	399803,977	0,79	16,492	10272,076	39,998
26/09/2018 04:00	2,517	398716,597	0,81	16,921	10277,313	40,001
26/09/2018 05:00	2,52	398422,245	0,808	17,093	10263,7	39,996
26/09/2018 06:00	2,522	398151,097	0,787	17,413	10274,235	39,996
26/09/2018 07:00	2,499	380996,536	0,801	17,202	9836,063	37,683
26/09/2018 08:00	2,379	385938,905	0,807	17,311	9974,241	38,629
26/09/2018 09:00	2,437	421462,665	0,723	16,013	10807,37	42,998
26/09/2018 10:00	2,531	420157,046	0,88	15,45	10803,497	43,004
26/09/2018 11:00	2,493	421812,653	0,771	16,082	10802,585	42,997
26/09/2018 12:00	2,545	422457,203	0,768	16,952	10802,92	42,999
26/09/2018 13:00	2,58	421977,522	0,775	16,577	10801,03	42,996
26/09/2018 14:00	2,402	423811,517	0,779	16,432	10875,885	43,477
26/09/2018 15:00	2,254	431330,034	0,749	16,177	11205,435	45
26/09/2018 16:00	2,252	431026,365	0,751	15,474	11213,192	45,003
26/09/2018 17:00	2,219	431051,594	0,745	15,306	11218,022	45,001
26/09/2018 18:00	2,268	431217,877	0,743	15,691	11221,686	45,001
26/09/2018 19:00	2,4	430901,08	0,755	16,223	11230,095	45,001
26/09/2018 20:00	2,629	430585,493	0,752	17,484	11236,374	45
26/09/2018 21:00	2,652	430578,405	0,748	17,667	11237,305	45,002
26/09/2018 22:00	2,645	430689,241	0,759	17,538	11236,993	45,002
26/09/2018 23:00	2,935	430615,329	0,762	17,901	11230,887	45,003
27/09/2018 00:00	2,66	430390,109	0,735	17,215	11232,618	45
27/09/2018 01:00	2,857	430068,381	0,748	17,604	11228,096	45,001
27/09/2018 02:00	2,721	429990,278	0,754	17,4	11230,172	44,996
27/09/2018 03:00	2,539	429294,21	0,753	16,797	11232,597	45,001
27/09/2018 04:00	2,544	429262,241	0,751	16,83	11231,45	44,998
27/09/2018 05:00	2,681	429026,314	0,753	17,361	11212,395	45,002
27/09/2018 06:00	2,536	429626,488	0,717	17,432	11225,012	45,003
27/09/2018 07:00	2,702	430625,452	0,738	17,612	11227,527	45,002
27/09/2018 08:00	2,8	431406,648	0,746	17,56	11222,414	44,999
27/09/2018 09:00	2,271	431851,71	0,695	15,696	11232,509	44,997
27/09/2018 10:00	10,123	431664,212	0,636	17,557	11230,634	44,998
27/09/2018 11:00	9,547	431467,092	0,371	17,557	11219,413	45
27/09/2018 12:00		430681,603	0,758	17,557	11221,758	44,998
27/09/2018 13:00	1,805	430541,114	0,787	15,77	11222,962	45,003
27/09/2018 14:00	1,776	430134,09	0,817	15,461	11222,696	45,004
27/09/2018 15:00	1,755	431300,683	0,785	15,046	11212,604	45
27/09/2018 16:00	1,711	431641,744	0,775	15,223	11212,192	44,996
27/09/2018 17:00	1,764	430895,489	0,756	15,179	11213,657	45
27/09/2018 18:00	1,833	430766,918	0,754	16,077	11209,001	45,001
27/09/2018 19:00	1,905	430652,845	0,747	16,038	11210,98	45,003
27/09/2018 20:00	2,036	430206,83	0,772	16,47	11213,151	44,999
27/09/2018 21:00	2,138	431040,329	0,764	16,48	11227,294	44,997
27/09/2018 22:00	2,211	432308,555	0,771	17,054	11221,352	44,999
27/09/2018 23:00	1,946	432159,986	0,771	16,79	11220,488	45
28/09/2018 00:00	2,154	431149,036	0,779	17,105	11218,576	45,001
28/09/2018 01:00	3,087	430407,729	0,776	17,722	11210,1	45,005
28/09/2018 02:00	2,733	430040,99	0,749	17,833	11209,069	44,998
28/09/2018 03:00	2,754	429739,364	0,77	17,806	11205,191	44,998
28/09/2018 04:00	2,961	429763,067	0,772	17,74	11200,662	44,996
28/09/2018 05:00	3,058	429677,285	0,785	17,745	11183,777	45,001
28/09/2018 06:00	2,318	430670,644	0,774	17,731	11202,14	45
28/09/2018 07:00	2,751	431902,145	0,788	17,761	11210,552	44,998
28/09/2018 08:00	3,077	432185,906	0,786	17,644	11201,623	45,001
28/09/2018 09:00	2,178	431951,907	0,756	17,378	11196,312	45,001
28/09/2018 10:00	2,092	433266,466	0,771	16,904	11194,746	45,001
28/09/2018 11:00	2,105	432411,754	0,845	17,431	11190,094	44,999
28/09/2018 12:00	4,194	432542,769	0,828	17,198	11188,09	44,999
28/09/2018 13:00	134,929	433038,799	0,791	15,449	11180,998	45,002
28/09/2018 14:00	1,636	432403,897	0,837	14,476	11186,261	45
28/09/2018 15:00	1,617	432549,074	0,829	14,137	11187,209	45,001
28/09/2018 16:00	1,628	431905,463	0,835	14,047	11192,428	44,999
28/09/2018 17:00	1,613	431079,061	0,844	13,934	11198,836	45,003
28/09/2018 18:00	1,72	430800,893	0,847	13,931	11205,036	45,002
28/09/2018 19:00	2,033	430596,658	0,852	15,197	11204,234	45,001
28/09/2018 20:00	2,516	431328,86	0,852	15,89	11211,493	45,003
28/09/2018 21:00	3,553	431534,892	0,859	15,868	11215,962	44,998
28/09/2018 22:00	4,015	429885,158	0,843	15,968	11200,138	44,793
28/09/2018 23:00	1,733	414823,538	0,852	16,039	10783,887	42,565
29/09/2018 00:00	1,736	414605,959	0,829	16,249	10764,088	42,5
29/09/2018 01:00	1,744	414789,27	0,855	16,416	10762,982	42,495
29/09/2018 02:00	1,76	415263,263	0,846	16,625	10761,15	42,501
29/09/2018 03:00	1,741	415310,605	0,851	16,775	10759,197	42,497
29/09/2018 04:00	1,785	415682,836	0,879	16,739	10761,663	42,498
29/09/2018 05:00	1,768	415840,233	0,867	16,616	10759,196	42,5
29/09/2018 06:00	1,773	415823,61	0,863	16,698	10764,383	42,502
29/09/2018 07:00	1,756	415649,976	0,884	16,622	10763,312	42,498
29/09/2018 08:00	1,737	414975,021	0,867	16,611	10763,274	42,501
29/09/2018 09:00	1,77	415156,424	0,809	16,525	10760,258	42,498
29/09/2018 10:00	1,763	414651,652	0,851	15,879	10756,287	42,494
29/09/2018 11:00	1,776	413744,767	0,867	15,648	10720,984	42,339
29/09/2018 12:00	1,754	410914,027	0,874	15,5	10649,764	42,001
29/09/2018 13:00	1,935	417421,596	0,892	18,624	10726,776	42,436
29/09/2018 14:00	1,927	418433,62	0,879	19,366	10729,611	42,496
29/09/2018 15:00	1,936	417302,643	0,89	18,442	10751,439	42,52
29/09/2018 16:00	1,838	421268,821	0,907	19,569	10840,656	43
29/09/2018 17:00	1,801	420854,35	0,895	19,518	10839,443	43,003
29/09/2018 18:00	1,84	421216,146	0,899	19,608	10844,183	43,001
29/09/2018 19:00	1,97	422283,763	0,905	19,624	10842,35	42,998
29/09/2018 20:00	2,104	422618,154	0,881	19,714	10842,299	43,002

29/09/2018 21:00	2,202	423203,412	0,892	19,792	10847,961	43,004
29/09/2018 22:00	2,381	424232,736	0,888	19,992	10841,008	42,997
29/09/2018 23:00	2,535	424318,613	0,875	19,917	10842,389	43,002
30/09/2018 00:00	10,047	410302,246	0,867	18,418	10588,195	41,509
30/09/2018 01:00	39,945	372867,412	0,931	10,976	9293,954	34,998
30/09/2018 02:00	43,434	373518,123	0,935	10,998	9295,782	35,001
30/09/2018 03:00	44,792	373836,044	0,926	11,054	9295,202	35,001
30/09/2018 04:00	44,243	374206,988	0,938	10,994	9290,357	34,999
30/09/2018 05:00	49,511	374381,147	0,939	10,811	9294,983	35
30/09/2018 06:00	31,045	380402,714	0,905	10,746	9482,215	36,001
30/09/2018 07:00	30,019	380456,377	0,931	10,687	9491,837	35,999
30/09/2018 08:00	29,963	379877,623	0,937	10,613	9487,707	36,001
30/09/2018 09:00	27,56	379317,911	0,869	10,654	9480,765	36,001
30/09/2018 10:00	28,249	380073,572	0,937	10,591	9480,006	35,997
30/09/2018 11:00	27,21	379903,457	1,507	10,659	9484,724	36,001
30/09/2018 12:00	24,938	380127,511	0,907	10,693	9486,001	35,997
30/09/2018 13:00	19,603	378846,446	0,922	10,823	9490,929	35,996
30/09/2018 14:00	39,962	371624,701	0,933	10,773	9314,781	34,883
30/09/2018 15:00	365,955	323249,475	0,982	11,519	7822,962	25,927
30/09/2018 16:00	242,718	123068,733	5,4	5,59	4384,281	12,098
30/09/2018 17:00		0	0	0,179	0	0
30/09/2018 18:00		0	0	0,056	0	0
30/09/2018 19:00		0	0	0,044	0	0
30/09/2018 20:00		0	0	0,038	0	0
30/09/2018 21:00		0	0	0,034	0	0
30/09/2018 22:00		0	0	0,249	485,509	0
30/09/2018 23:00		0	0	0,67	94,698	0
01/10/2018 00:00		0	0	0,046	0	0
01/10/2018 01:00		0	0	0,018	0	0
01/10/2018 02:00		0	0	0,011	0	0
01/10/2018 03:00		0	0	0,007	0	0
01/10/2018 04:00		0	0	0,007	0	0
01/10/2018 05:00		0	0	0,012	0	0
01/10/2018 06:00		0	0	0,041	0	0
01/10/2018 07:00		0	0	0,066	0	0
01/10/2018 08:00		0	0	0,056	0	0
01/10/2018 09:00		0	0	0,037	0	0
01/10/2018 10:00		0	0	0,028	0	0
01/10/2018 11:00		0	0	0,021	0	0
01/10/2018 12:00		0	0	0,008	0	0
01/10/2018 13:00		0	0	0,003	0	0
01/10/2018 14:00		0	0	0,001	0	0
01/10/2018 15:00		0	0	0,002	0	0
01/10/2018 16:00		0	0	0,003	0	0
01/10/2018 17:00		0	0	0,004	0	0
01/10/2018 18:00		0	0	0,009	0	0
01/10/2018 19:00		0	0	0,014	0	0
01/10/2018 20:00		0	0	0,012	0	0
01/10/2018 21:00		0	0	0,003	0	0
01/10/2018 22:00		0	0	0,003	0	0
01/10/2018 23:00		0	0	0,001	0	0
02/10/2018 00:00		0	0	0	0	0
02/10/2018 01:00		0	0	0	0	0
02/10/2018 02:00		0	0	0	0	0
02/10/2018 03:00		0	0	0,001	0	0
02/10/2018 04:00		0	0	0,018	0	0
02/10/2018 05:00		0	0	0,005	0	0
02/10/2018 06:00		0	0	0,001	0	0
02/10/2018 07:00		0	0	0,01	0	0
02/10/2018 08:00		0	0	0,014	0	0
02/10/2018 09:00		0	0	0,02	0	0
02/10/2018 10:00		0	0	0,033	0	0
02/10/2018 11:00		0	0	0,039	0	0
02/10/2018 12:00		0	0	0,029	0	0
02/10/2018 13:00		0	0	0,003	0	0
02/10/2018 14:00		0	0	0	0	0
02/10/2018 15:00		0	0	0	0	0
02/10/2018 16:00		0	0	0,002	0	0
02/10/2018 17:00		0	0	0,006	0	0
02/10/2018 18:00		0	0	0,01	0	0
02/10/2018 19:00		0	0	0,007	0	0
02/10/2018 20:00		0	0	0,007	0	0
02/10/2018 21:00		0	0	0	0	0
02/10/2018 22:00		0	0	0	0	0
02/10/2018 23:00		0	0	0	0	0
03/10/2018 00:00		0	0	0,005	0	0
03/10/2018 01:00		0	0	0,01	0	0
03/10/2018 02:00		0	0	0,004	0	0
03/10/2018 03:00		0	0	0,002	0	0
03/10/2018 04:00		0	0	0,009	0	0
03/10/2018 05:00		0	0	0,017	0	0
03/10/2018 06:00		0	0	0,019	0	0
03/10/2018 07:00		0	0	0,019	0	0
03/10/2018 08:00		0	0	0,049	0	0
03/10/2018 09:00		0	0	0,044	0	0
03/10/2018 10:00		0	0	0,034	0	0
03/10/2018 11:00		0	0	0,028	0	0
03/10/2018 12:00		0	0	0,012	0	0
03/10/2018 13:00		0	0	0,002	0	0
03/10/2018 14:00		0	0	0,002	0	0
03/10/2018 15:00		0	0	0,002	0	0
03/10/2018 16:00		0	0	0,002	0	0
03/10/2018 17:00		0	0	0,007	0	0
03/10/2018 18:00		0	0	0,018	0	0
03/10/2018 19:00		0	0	0,017	0	0
03/10/2018 20:00		0	0	0,002	0	0
03/10/2018 21:00		0	0	0,001	0	0
03/10/2018 22:00		0	0	0	0	0
03/10/2018 23:00		0	0	0,005	0	0
04/10/2018 00:00		0	0	0,018	0	0
04/10/2018 01:00		0	0	0,024	0	0
04/10/2018 02:00		0	0	0,016	0	0

04/10/2018 03:00		0	0	0,008	0	0
04/10/2018 04:00		0	0	0,006	0	0
04/10/2018 05:00		0	0	0,001	0	0
04/10/2018 06:00		0	0	0,01	0	0
04/10/2018 07:00		0	0	0,018	0	0
04/10/2018 08:00		0	0	0,031	0	0
04/10/2018 09:00		0	0	6,997	0	0
04/10/2018 10:00		0	0	0,028	0	0
04/10/2018 11:00		0	0	0,02	0	0
04/10/2018 12:00		0	0	0,014	0	0
04/10/2018 13:00		0	0	0,014	0	0
04/10/2018 14:00		0	0	3,041	0	0
04/10/2018 15:00		0	0	2,519	0	0
04/10/2018 16:00		0	0	0,004	0	0
04/10/2018 17:00		0	0	0,004	0	0
04/10/2018 18:00		0	0	0,004	0	0
04/10/2018 19:00		0	0	0,01	0	0
04/10/2018 20:00		0	0	0,019	0	0
04/10/2018 21:00		0	0	0,016	0	0
04/10/2018 22:00		0	0	0,026	0	0
04/10/2018 23:00		0	0	0,018	0	0
05/10/2018 00:00		0	0	0,008	0	0
05/10/2018 01:00		0	0	0,009	0	0
05/10/2018 02:00		0	0	0,015	0	0
05/10/2018 03:00		0	0	0,007	0	0
05/10/2018 04:00		0	0	0,009	0	0
05/10/2018 05:00		0	0	0,008	0	0
05/10/2018 06:00		0	0	0,034	0	0
05/10/2018 07:00		0	0	0,027	0	0
05/10/2018 08:00		0	0	0,044	0	0
05/10/2018 09:00		0	0	0,058	0	0
05/10/2018 10:00		0	0	3,564	0	0
05/10/2018 11:00		0	0	0,04	0	0
05/10/2018 12:00		0	0	0,025	0	0
05/10/2018 13:00		0	0	0,007	0	0
05/10/2018 14:00		0	0	0,002	0	0
05/10/2018 15:00		0	0	0,005	145,76	0
05/10/2018 16:00		0	0	0,005	121,804	0
05/10/2018 17:00		0	0	0,004	0	0
05/10/2018 18:00		0	0	0,008	0	0
05/10/2018 19:00		0	0,167	4,985	3967,172	11,792
05/10/2018 20:00	440,699	0	0,081	12,516	7020,44	21,999
05/10/2018 21:00	152,577	0	0,298	5,003	7714,948	25,699
05/10/2018 22:00	306,183	5340,42	0,26	7,907	7071,509	21,998
05/10/2018 23:00	79,359	215648,601	0,1	11,398	8930,178	32,83
06/10/2018 00:00	28,924	201381,239	0,101	10,964	9170,042	33,999
06/10/2018 01:00	35,175	202621,496	0,084	10,836	9167,913	34,003
06/10/2018 02:00	37,74	201647,813	0,09	10,73	9166,487	33,997
06/10/2018 03:00	37,085	203498,476	0,079	10,616	9162,773	34,003
06/10/2018 04:00	42,171	203706,401	0,095	10,345	9162,754	33,998
06/10/2018 05:00	47,076	203600,753	0,095	11,133	9265,436	34,392
06/10/2018 06:00	27,659	204439,272	0,108	11,482	9366,378	34,997
06/10/2018 07:00	17,357	203911,382	0,146	11,951	9368,613	35
06/10/2018 08:00	11,499	200439,095	0,142	12,295	9356,527	35,006
06/10/2018 09:00	6,082	260148,356	3,67	12,826	9349,858	35,002
06/10/2018 10:00	75,704	106533,063	76,322	7,712	4781,92	14,231
06/10/2018 11:00		0	0	0,208	0	0
06/10/2018 12:00		0	0	0,045	0	0
06/10/2018 13:00		0	0	0,026	0	0
06/10/2018 14:00	17,215	83697,555	59,627	8,315	5545,471	19,731
06/10/2018 15:00	21,076	304487,992	0,687	15,416	8459,289	30,759
06/10/2018 16:00	40,909	253991,4	1,37	15,613	8311,518	29,855
06/10/2018 17:00	37,007	256668,583	0,273	14,747	8339,361	30
06/10/2018 18:00	41,992	270222,808	0,117	14,644	8342,327	30,002
06/10/2018 19:00	70,891	278159,235	0,099	14,335	8364,72	29,998
06/10/2018 20:00	95,069	278459,868	0,092	13,934	8384,459	29,998
06/10/2018 21:00	103,797	280101,876	0,087	14,3	8382,435	29,996
06/10/2018 22:00	49,25	291298,44	0,103	13,114	8838,007	32,25
06/10/2018 23:00	14,238	307414,664	0,196	12,011	9166,661	34,001
07/10/2018 00:00	13,386	361584,532	0,815	11,993	9182,154	34,002
07/10/2018 01:00	14,204	361632,911	0,834	11,999	9179,591	34,001
07/10/2018 02:00	6,078	379521,607	0,805	14,092	9843,067	37,209
07/10/2018 03:00	8,742	370823,828	0,691	14,103	9824,526	37,131
07/10/2018 04:00	2,097	397227,362	0,778	16,183	10383,972	40,001
07/10/2018 05:00	2,019	397106,121	0,782	16,408	10382,885	39,995
07/10/2018 06:00	2,022	397675,249	0,74	15,838	10380,759	39,999
07/10/2018 07:00	2,05	397742,022	0,753	15,612	10371,136	40,001
07/10/2018 08:00	2	395028,157	0,754	15,694	10360,281	39,888
07/10/2018 09:00	2,077	388331,35	0,698	15,981	10173,139	38,997
07/10/2018 10:00	2,079	395786,942	0,774	20,08	10336,531	39,999
07/10/2018 11:00	2,006	387214,334	0,762	17,05	10202,714	38,967
07/10/2018 12:00	2,111	393873,426	0,843	18,188	10239,963	39,541
07/10/2018 13:00	3,409	399830,977	0,844	18,487	10345,388	40,006
07/10/2018 14:00	5,049	400045,354	0,847	18,066	10352,773	39,998
07/10/2018 15:00	3,03	399125,051	0,838	18,946	10352,613	40,002
07/10/2018 16:00	2,258	398447,434	0,849	20,215	10358,475	40,002
07/10/2018 17:00	2,757	399311,166	0,851	19,437	10362,585	39,997
07/10/2018 18:00	3,489	399411,492	0,856	18,869	10370,156	39,998
07/10/2018 19:00	8,211	401420,67	0,857	18,006	10359,76	40,001
07/10/2018 20:00	14,748	403275,617	0,855	17,655	10366,599	40,001
07/10/2018 21:00	22,188	404271,43	0,86	17,031	10391,403	39,998
07/10/2018 22:00	28,25	404669,262	0,852	16,719	10384,168	40,001
07/10/2018 23:00	27,682	404734,248	0,861	16,7	10372,607	40
08/10/2018 00:00	16,959	401898,647	0,837	15,131	10383,271	40,005
08/10/2018 01:00	2,351	400937,375	0,835	14,267	10395,306	40
08/10/2018 02:00	2,124	400065,215	0,85	14,374	10397,817	39,994
08/10/2018 03:00	2,059	400686,562	0,848	14,493	10405,465	39,999
08/10/2018 04:00	2,342	401460,551	0,838	14,102	10402,381	39,999
08/10/2018 05:00	2,289	401376,394	0,851	14,134	10390,463	39,999
08/10/2018 06:00	2,232	401350,724	0,812	14,227	10408,753	40,003
08/10/2018 07:00	2,176	399974,874	0,841	14,375	10416,296	40,001
08/10/2018 08:00	2,062	414308,001	0,848	15,987	10911,152	42,468

08/10/2018 09:00	1,844	417256,425	0,75	16,453	11016,731	42,961
08/10/2018 10:00	1,889	415352,533	0,816	16,432	10966,09	42,714
08/10/2018 11:00	1,858	415181,857	0,822	16,864	10905,747	42,602
08/10/2018 12:00	1,859	427164,623	0,881	20,012	11180,058	44,002
08/10/2018 13:00	1,86	426226,366	0,877	18,652	11139,733	44,001
08/10/2018 14:00	1,825	420753,727	0,885	19,319	10962,469	43,152
08/10/2018 15:00	1,801	418188,694	0,885	18,178	10925,148	43
08/10/2018 16:00	1,799	417321,494	0,885	17,68	10925,39	42,999
08/10/2018 17:00	1,812	418320,694	0,89	17,81	10945,18	43,003
08/10/2018 18:00	1,882	419145,428	0,899	19,73	10973,415	43,002
08/10/2018 19:00	1,991	419812,645	0,905	19,995	11004,394	43,001
08/10/2018 20:00	1,675	430166,508	0,907	15,588	11913,076	47,571
08/10/2018 21:00	1,743	430949,034	0,895	14,765	12028,253	47,999
08/10/2018 22:00	2,913	425657,882	0,912	17,523	11364,517	44,602
08/10/2018 23:00	5,319	423696,93	0,915	18,779	11045,321	43,001
09/10/2018 00:00	6,202	425360,108	0,899	18,591	11041,765	42,999
09/10/2018 01:00	5,709	425198,775	0,917	18,441	11047,166	43
09/10/2018 02:00	5,536	425413,356	0,923	18,375	11053,51	42,997
09/10/2018 03:00	6,63	425158,384	0,918	18,297	11047,552	42,998
09/10/2018 04:00	10,24	425598,61	0,936	18,025	11041,389	43,001
09/10/2018 05:00	11,02	427446,093	0,932	17,941	11244,904	44,145
09/10/2018 06:00	2,803	429111,544	0,876	16,616	12001,815	47,683
09/10/2018 07:00	30,402	384318,475	0,962	10,69	9841,324	36,962
09/10/2018 08:00	17,834	400352,931	0,933	12,159	10526,208	40,53
09/10/2018 09:00	1,919	433165,871	0,812	14,7	11926,289	47,502
09/10/2018 10:00	1,759	433151,338	0,878	13,995	11931,123	47,505
09/10/2018 11:00	1,763	433266,235	0,875	14,416	11925,82	47,5
09/10/2018 12:00	1,679	433696,949	0,884	15,252	11916,698	47,502
09/10/2018 13:00	1,646	432410,662	0,851	15,538	11896,171	47,501
09/10/2018 14:00	1,645	432361,202	0,852	15,594	11883,859	47,501
09/10/2018 15:00	1,628	432007,633	0,851	15,612	11887,66	47,501
09/10/2018 16:00	1,634	431972,693	0,842	15,681	11897,292	47,502
09/10/2018 17:00	1,638	432269,988	0,842	15,67	11903,275	47,501
09/10/2018 18:00	1,654	432515,441	0,845	15,616	11902,726	47,496
09/10/2018 19:00	1,708	431848,051	0,84	15,675	11914,85	47,498
09/10/2018 20:00	1,709	428110,551	0,864	15,167	11917,871	47,5
09/10/2018 21:00	21,257	215138,286	0,461	10,391	9912,202	37,302
09/10/2018 22:00	10,91	405378,894	0,942	16,764	10454,73	40,227
09/10/2018 23:00	4,677	417008,435	0,941	18,906	10815,07	41,995
10/10/2018 00:00	5,434	414806,911	0,932	18,802	10811,407	41,997
10/10/2018 01:00	6,598	415687,017	0,921	18,64	10814,908	41,999
10/10/2018 02:00	7,925	416463,919	0,932	18,367	10812,109	41,997
10/10/2018 03:00	10,083	417225,069	0,933	18,238	10820	42,003
10/10/2018 04:00	9,099	416394,031	0,942	18,334	10812,336	41,998
10/10/2018 05:00	10,981	416501,255	0,924	18,108	10796,741	42
10/10/2018 06:00	12,619	418403,811	0,872	17,815	10875,068	42,452
10/10/2018 07:00	1,964	428308,755	0,875	15,955	12409,436	49,999
10/10/2018 08:00	1,927	428368,075	0,876	15,884	12402,006	49,996
10/10/2018 09:00	1,826	428737,12	0,795	15,812	12389,718	50
10/10/2018 10:00	1,869	427930,577	0,877	15,813	12385,825	50,005
10/10/2018 11:00	1,99	428889,22	0,869	16,103	12351,582	49,937
10/10/2018 12:00	1,846	428665,614	0,838	16,231	12166,857	49,076
10/10/2018 13:00	1,893	428748,975	0,84	16,05	12042,094	48,47
10/10/2018 14:00	1,725	429519,358	0,83	16,076	12030,052	48,468
10/10/2018 15:00	1,741	429608,25	0,823	16,153	12103,236	48,62
10/10/2018 16:00	1,719	430631,278	0,839	15,879	12078,58	48,509
10/10/2018 17:00	1,788	429285,403	0,848	15,598	12039,134	48,259
10/10/2018 18:00	1,758	428110,203	0,856	15,557	12025,214	48,164
10/10/2018 19:00	1,769	427850,572	0,838	15,601	12025,201	48,166
10/10/2018 20:00	1,812	427742,12	0,84	15,549	12027,271	48,167
10/10/2018 21:00	1,653	428086,185	0,847	15,972	11990,395	47,943
10/10/2018 22:00	1,795	428228,946	0,849	15,841	11947,744	47,829
10/10/2018 23:00	1,718	428401,81	0,852	16,02	11963,587	47,866
11/10/2018 00:00	1,618	429953,68	0,84	15,908	11887,871	47,503
11/10/2018 01:00	1,624	429683,061	0,844	15,425	11784,697	47
11/10/2018 02:00	1,628	429736,607	0,845	15,484	11786,294	47,001
11/10/2018 03:00	1,631	429649,873	0,851	15,467	11785,41	46,998
11/10/2018 04:00	1,666	429564,109	0,844	15,459	11781,505	46,998
11/10/2018 05:00	1,826	429537,311	0,847	14,572	11772,278	47,004
11/10/2018 06:00	1,796	430153,353	0,816	14,065	11787,027	47,005
11/10/2018 07:00	1,824	428559,375	0,852	14,08	11795,329	46,996
11/10/2018 08:00	1,777	429204,948	0,838	14,16	11788,128	46,998
11/10/2018 09:00	1,791	429197,39	0,782	14,431	11789,034	46,996
11/10/2018 10:00	1,836	429546,239	0,829	14,324	11777,143	47,003
11/10/2018 11:00	1,703	428885,414	0,833	14,44	11778,78	46,998
11/10/2018 12:00	1,847	430214,066	0,897	15,202	11772,498	46,994
11/10/2018 13:00	1,695	430574,328	0,852	15,594	11755,993	47,004
11/10/2018 14:00	1,677	431251,425	0,847	15,719	11734,644	47,003
11/10/2018 15:00	1,685	430915,375	0,85	15,66	11728,548	46,998
11/10/2018 16:00	1,667	431751,476	0,844	15,651	11730,958	46,999
11/10/2018 17:00	1,725	431125,129	0,843	15,711	11741,922	46,999
11/10/2018 18:00	1,67	431021,449	0,847	15,103	11764,028	46,999
11/10/2018 19:00	1,71	429211,452	0,846	14,433	11790,059	47,001
11/10/2018 20:00	1,806	430394,921	0,834	14,659	11806,828	47
11/10/2018 21:00	2,034	429446,149	0,849	15,529	11814,566	47,005
11/10/2018 22:00	2,402	429746,749	0,858	16,282	11819,499	47,001
11/10/2018 23:00	2,974	428904,827	0,853	16,77	11821,9	47
12/10/2018 00:00	3,703	428966,723	0,845	16,896	11818,072	47,003
12/10/2018 01:00	5,475	428244,636	0,852	16,79	11814,806	47,003
12/10/2018 02:00	5,574	429248,212	0,855	16,803	11824,757	47,001
12/10/2018 03:00	8,06	428339,51	0,854	16,471	11819,178	46,999
12/10/2018 04:00	6,06	429336,657	0,865	16,593	11820,279	47,003
12/10/2018 05:00	7,266	428300,692	0,863	16,489	11803,714	47,002
12/10/2018 06:00	6,638	429217,291	0,824	16,606	11811,247	46,999
12/10/2018 07:00	5,981	427255,531	0,886	16,697	11807,67	47,002
12/10/2018 08:00	5,734	428495,734	0,87	16,791	11809,277	47,001
12/10/2018 09:00		428097,694	0,981	17,997	11797,357	46,998
12/10/2018 10:00	3,429	428171,681	0,867	16,935	11800,839	47,001
12/10/2018 11:00	2,153	428230,839	0,858	15,714	11806,139	47
12/10/2018 12:00	1,824	427523,38	0,849	14,437	11791,825	47,009
12/10/2018 13:00	1,761	427594,457	0,876	14,317	11778,963	47
12/10/2018 14:00	1,681	427558,886	0,876	14,669	11766,354	47,002

12/10/2018 15:00	1,653	428620,758	0,87	15,054	11752,337	47
12/10/2018 16:00	1,654	429796,56	0,873	15,413	11742,353	47,003
12/10/2018 17:00	1,659	429453,712	0,876	14,978	11752,523	47,003
12/10/2018 18:00	1,782	428868,293	0,889	15,274	11783,1	47
12/10/2018 19:00	1,859	417067,469	0,891	16,917	11129,837	43,385
12/10/2018 20:00	1,872	416550,014	0,89	16,927	11055,284	42,963
12/10/2018 21:00	1,908	418306,094	0,895	17,01	11098,39	43,172
12/10/2018 22:00	1,956	420515,208	0,893	17,145	11150,702	43,436
12/10/2018 23:00	1,934	422613,957	0,899	17,235	11196,223	43,659
13/10/2018 00:00	1,949	424286,923	0,881	17,294	11223,093	43,782
13/10/2018 01:00	1,906	423409,828	0,915	17,201	11195,604	43,664
13/10/2018 02:00	1,933	422894,849	0,914	17,202	11177,196	43,624
13/10/2018 03:00	1,946	426031,165	0,908	17,413	11247,853	43,958
13/10/2018 04:00	1,969	426942,956	0,885	17,442	11290,144	44,133
13/10/2018 05:00	1,92	428011,001	0,895	17,568	11307,006	44,2
13/10/2018 06:00	1,876	427960,287	0,863	17,689	11315,927	44,248
13/10/2018 07:00	2,802	428971,612	0,899	18,906	11552,784	45,479
13/10/2018 08:00	1,939	429832,618	0,889	21,36	11632,809	45,998
13/10/2018 09:00	1,956	430872,521	0,821	20,73	11626,792	45,998
13/10/2018 10:00	8,08	416066,984	0,922	15,816	11085,079	43,231
13/10/2018 11:00	4,527	429671,884	0,903	16,788	11588,972	46,007
13/10/2018 12:00	2,279	429552,92	0,84	15,712	11582,675	45,996
13/10/2018 13:00	2,151	429759,426	0,902	15,262	11477,491	45,49
13/10/2018 14:00	1,861	429747,025	0,909	15,035	11336,408	44,997
13/10/2018 15:00	1,721	429738,612	0,906	14,475	11324,806	44,998
13/10/2018 16:00	1,696	429787,983	0,905	14,38	11330,364	44,997
13/10/2018 17:00	1,658	429602,172	0,89	15,582	11814,868	47,483
13/10/2018 18:00	1,636	429745,059	0,887	15,914	11984,26	47,998
13/10/2018 19:00	1,648	429918,539	0,892	15,636	12009,199	47,999
13/10/2018 20:00	1,679	429075,975	0,887	15,312	12022,128	47,997
13/10/2018 21:00	1,727	428089,829	0,89	14,933	12029,033	48,001
13/10/2018 22:00	1,742	428179,992	0,893	14,676	12026,225	48,001
13/10/2018 23:00	2,264	428344,048	0,917	17,414	11711,602	46,499
14/10/2018 00:00	2,175	428619,841	0,895	20,814	11424,909	45
14/10/2018 01:00	2,154	428589,045	0,92	20,637	11432,636	45,002
14/10/2018 02:00	2,972	428513,025	0,928	20,637	11429,124	45,005
14/10/2018 03:00	3,142	428991,979	0,93	20,575	11430,392	45,001
14/10/2018 04:00	3,115	429488,331	0,944	20,618	11435,536	44,998
14/10/2018 05:00	3,055	429516,672	0,941	20,653	11440,989	44,999
14/10/2018 06:00	3,358	430312,647	0,89	20,616	11443,015	45,002
14/10/2018 07:00	2,739	429939,022	0,91	20,596	11421,136	44,765
14/10/2018 08:00	3,735	422698,823	0,939	19,495	11035,373	42,998
14/10/2018 09:00	2,371	421239,564	0,822	20,015	11009,328	43,004
14/10/2018 10:00	1,976	419130,344	0,917	19,721	11000,568	43,003
14/10/2018 11:00	1,939	417843,032	0,909	18,46	10996,248	43
14/10/2018 12:00	1,878	415802,86	0,908	17,432	10989,055	42,996
14/10/2018 13:00	2,274	419245,437	0,85	16,04	10955,346	43,001
14/10/2018 14:00	1,846	418313,222	0,868	15,039	10940,34	43,001
14/10/2018 15:00	1,814	417889,169	0,865	14,659	10925,539	42,997
14/10/2018 16:00	1,766	417525,252	0,86	14,439	10918,884	43,002
14/10/2018 17:00	1,754	416473,83	0,852	14,487	10928,157	43
14/10/2018 18:00	1,891	417611,234	0,854	14,732	10958,577	42,998
14/10/2018 19:00	2,975	419507,743	0,858	15,725	10996,478	43
14/10/2018 20:00	5,288	420059,782	0,863	15,706	11009,417	43
14/10/2018 21:00	1,926	417843,159	0,87	18,258	11036,859	42,997
14/10/2018 22:00	1,924	420657,608	0,89	18,473	11213,006	44,018
14/10/2018 23:00	1,98	430730,242	0,883	15,225	11665,083	46,201
15/10/2018 00:00	2,145	430443,499	0,871	15,66	11600,377	45,997
15/10/2018 01:00	1,903	430594,125	0,871	14,928	11605,275	46,002
15/10/2018 02:00	2,245	430701,247	0,877	15,426	11604,621	46,003
15/10/2018 03:00	2,668	429913,367	0,89	16,174	11599,262	46
15/10/2018 04:00	3,012	429530,129	0,864	16,329	11601,597	46
15/10/2018 05:00	2,99	429569,021	0,84	16,357	11606,685	46
15/10/2018 06:00	2,933	429611,739	0,827	16,087	11608,27	46
15/10/2018 07:00	2,206	429813,12	0,86	15,024	11607,853	46
15/10/2018 08:00	1,738	430070,697	0,864	14,102	11598,59	46,002
15/10/2018 09:00	1,756	430069,852	0,777	14,964	11577,805	45,999
15/10/2018 10:00	1,755	429853,682	0,837	15,235	11565,435	46,007
15/10/2018 11:00	1,731	429983,18	0,835	15,234	11560,767	45,998
15/10/2018 12:00	1,736	430550,718	0,827	15,238	11560,956	46,003
15/10/2018 13:00	1,684	430195,11	0,86	15,373	11552,089	45,997
15/10/2018 14:00	1,676	430042,036	0,861	15,398	11539,43	45,994
15/10/2018 15:00	1,676	430462,014	0,858	15,41	11530,438	46,001
15/10/2018 16:00	1,687	431446,468	0,852	15,64	11505,68	46
15/10/2018 17:00	1,684	432191,804	0,85	15,62	11515,461	45,996
15/10/2018 18:00	1,669	431854,806	0,855	14,656	11542,084	46,003
15/10/2018 19:00	1,753	431170,274	0,862	14,932	11554,659	46,001
15/10/2018 20:00	2,03	430863,652	0,866	15,731	11572,738	45,996
15/10/2018 21:00	2,644	430777,355	0,867	16,775	11566,5	46,001
15/10/2018 22:00	2,938	431604,116	0,874	16,819	11573,613	46,002
15/10/2018 23:00	3,52	432599,627	0,867	16,821	11576,773	45,997
16/10/2018 00:00	4,694	432531,955	0,858	16,598	11577,764	45,999
16/10/2018 01:00	5,715	432098,108	0,886	17,569	11607,484	46,001
16/10/2018 02:00	1,842	431513,438	0,861	20,211	11626,743	46,001
16/10/2018 03:00	1,922	430873,695	0,868	20,835	11612,666	46,001
16/10/2018 04:00	2,037	431020,706	0,875	21,23	11604,893	45,999
16/10/2018 05:00	2,025	430346,072	0,853	21,151	11600,218	45,999
16/10/2018 06:00	1,931	429956,616	0,835	20,265	11609,526	46,003
16/10/2018 07:00	1,982	430484,652	0,876	19,516	11623,616	46,001
16/10/2018 08:00	1,945	431177,84	0,868	18,868	11606,4	45,997
16/10/2018 09:00	2,067	430073,301	0,81	18,955	11589,191	46
16/10/2018 10:00	4,86	429665,171	0,87	16,727	11537,174	45,871
16/10/2018 11:00	3,738	430243,019	0,859	16,719	11573,361	46,001
16/10/2018 12:00	24,323	394647,975	0,91	13,327	10283,865	39,236
16/10/2018 13:00	36,194	370534,215	0,959	10,792	9425,465	34,997
16/10/2018 14:00	39,127	370946,036	0,97	10,802	9425,754	34,999
16/10/2018 15:00	35,738	370141,912	0,948	10,854	9430,343	35,005
16/10/2018 16:00	23,147	386225,992	0,946	12,534	9957,481	37,673
16/10/2018 17:00	7,081	432386,143	0,901	16,11	11399,31	45,003
16/10/2018 18:00	6,562	431020,199	0,908	16,17	11392,865	44,999
16/10/2018 19:00	5,628	431028,627	0,9	17,306	11398,893	44,998
16/10/2018 20:00	1,92	431420,253	0,891	19,614	11428,031	45,006

16/10/2018 21:00	1,966	431429,197	0,892	20,45	11422,427	45,001
16/10/2018 22:00	2,01	431205,841	0,884	20,232	11429,945	44,998
16/10/2018 23:00	2,074	430626,043	0,914	20,922	11431,698	45,001
17/10/2018 00:00	2,331	429765,997	0,903	20,865	11430,925	45,004
17/10/2018 01:00	2,349	430063,021	0,91	20,983	11427,134	44,999
17/10/2018 02:00	2,379	430828,821	0,924	21,026	11425,072	44,999
17/10/2018 03:00	2,609	431331,627	0,922	20,965	11424,616	45
17/10/2018 04:00	2,256	431674,784	0,915	20,789	11426,973	44,997
17/10/2018 05:00	2,185	431276,722	0,902	20,838	11410,645	44,996
17/10/2018 06:00	2,033	430837,781	0,897	20,977	11422,521	45
17/10/2018 07:00	2,108	430593,251	0,936	21,101	11427,975	45
17/10/2018 08:00	1,957	430037,145	0,912	20,685	11422,408	44,998
17/10/2018 09:00	2,599	422962,573	0,828	19,723	11143,698	43,628
17/10/2018 10:00	3,641	419631,398	0,899	19,392	10952,313	42,726
17/10/2018 11:00	1,855	430695,576	0,873	17,494	11381,233	44,954
17/10/2018 12:00	2,047	431146,082	0,889	15,989	11364,918	44,997
17/10/2018 13:00	1,935	432670,406	0,9	15,485	11363,511	44,995
17/10/2018 14:00	16,371	365861,576	0,964	12,657	9354,632	34,597
17/10/2018 15:00	58,618	351888,475	0,994	12,681	8798,661	31,996
17/10/2018 16:00	51,253	352546,74	0,991	12,609	8830,97	32,246
17/10/2018 17:00	24,871	371044,961	0,972	14,353	9462,936	35,455
17/10/2018 18:00	18,845	365340,458	0,968	12,805	9350,577	34,681
17/10/2018 19:00	30,354	361978,608	0,989	11,647	9228,639	33,998
17/10/2018 20:00	48,996	363265,69	0,995	11,399	9223,436	34,003
17/10/2018 21:00	50,528	370301,747	0,986	11,737	9419,129	35,057
17/10/2018 22:00	2,776	426877,67	0,93	19,654	11144,403	43,659
17/10/2018 23:00	3,028	429550,066	0,918	20,128	11228,559	44,002
18/10/2018 00:00	3,464	429437,764	0,899	20,009	11227,636	44
18/10/2018 01:00	4,038	429579,247	0,915	19,933	11229,14	44,001
18/10/2018 02:00	4,58	429739,786	0,911	19,832	11234,385	44,002
18/10/2018 03:00	5,698	429709,383	0,921	19,645	11234,689	43,998
18/10/2018 04:00	6,04	429866,792	0,923	19,579	11228,288	43,998
18/10/2018 05:00	5,96	430161,6	0,916	19,792	11260,449	44,275
18/10/2018 06:00	4,264	427460,221	0,879	20,497	11383,17	44,524
18/10/2018 07:00	12,428	390064,599	0,943	12,579	10110,842	38,075
18/10/2018 08:00	5,232	387922,241	0,942	13,44	10053,962	38,001
18/10/2018 09:00	2,925	386266,86	0,847	13,736	10042,879	37,999
18/10/2018 10:00	2,129	384309,436	0,927	14,251	10031,462	38
18/10/2018 11:00	2,054	381683,59	0,925	15,133	10030,113	37,999
18/10/2018 12:00	3,676	381876,344	0,925	17,268	10012,303	38,003
18/10/2018 13:00	3,072	381780,458	0,89	19,095	9987,861	38,001
18/10/2018 14:00	2,342	381826,192	0,864	19,826	9972,298	37,996
18/10/2018 15:00	2,267	381984,143	0,872	20,005	9971,704	38,002
18/10/2018 16:00	2,277	382407,596	0,87	20,073	9978,414	37,999
18/10/2018 17:00	3,014	383488,838	0,872	19,198	9983,024	37,999
18/10/2018 18:00	8,259	384782,732	0,875	17,754	10000,127	38
18/10/2018 19:00	14,529	385584,485	0,869	17,39	10014,092	38,003
18/10/2018 20:00	22,029	386679,819	0,882	17,235	10021,78	37,999
18/10/2018 21:00	30,545	387907,16	0,887	16,673	10030,406	38
18/10/2018 22:00	35,06	388160,268	0,895	16,266	10031,37	38
18/10/2018 23:00	12,697	385678,227	0,902	14,104	10039,84	38,002
19/10/2018 00:00	3,077	392360,457	0,883	14,687	10246,392	38,995
19/10/2018 01:00	4,243	413601,716	0,872	18,995	10831,143	42
19/10/2018 02:00	5,797	414411,175	0,874	18,755	10821,622	42,002
19/10/2018 03:00	5,854	414629,141	0,889	18,794	10807,269	41,997
19/10/2018 04:00	6,484	415294,596	0,884	18,722	10802,281	42,001
19/10/2018 05:00	5,004	414929,737	0,879	18,967	10787,684	42,004
19/10/2018 06:00	4,144	414828,513	0,859	19,098	10799,211	41,998
19/10/2018 07:00	3,249	413264,783	0,875	19,335	10812,668	41,996
19/10/2018 08:00	36,293	398767,214	0,894	18,89	10406,852	39,76
19/10/2018 09:00		38372,332	22,913	6,702	1854,563	3,929
19/10/2018 10:00		0	0	4,3	0	0
19/10/2018 11:00		0	0	0,1	0	0
19/10/2018 12:00		0	0	0,065	0	0
19/10/2018 13:00		0	0	0,045	0	0
19/10/2018 14:00		0	0	0,038	0	0
19/10/2018 15:00		56081,762	4,439	5,638	3541,072	11,338
19/10/2018 16:00	2,092	427025,132	0,841	16,604	11349,468	45,502
19/10/2018 17:00	1,707	430874,476	0,8	16,054	11673,271	46,876
19/10/2018 18:00	1,702	430199,791	0,795	15,806	11719,515	47,002
19/10/2018 19:00	1,698	430836,245	0,799	15,587	11735,385	47,001
19/10/2018 20:00	1,687	430061,533	0,796	14,969	11736,396	46,999
19/10/2018 21:00	1,727	430403,979	0,8	14,57	11747,886	46,999
19/10/2018 22:00	1,861	430593,094	0,803	15,574	11745,542	46,998
19/10/2018 23:00	1,943	430102,199	0,801	15,935	11739,76	46,996
20/10/2018 00:00	2,453	428113,145	0,793	17,419	11735,492	47,002
20/10/2018 01:00	2,665	428498,937	0,811	17,607	11740,131	47
20/10/2018 02:00	3,118	428721,586	0,825	17,513	11740,351	46,993
20/10/2018 03:00	4,189	428775,615	0,817	17,272	11737,051	47,002
20/10/2018 04:00	4,594	428649,613	0,828	17,302	11737,865	46,978
20/10/2018 05:00	3,993	428467,981	0,842	17,355	11740,426	46,999
20/10/2018 06:00	10,875	424864,925	0,806	17,586	11203,712	44,265
20/10/2018 07:00	11,866	418074,757	0,824	17,949	10753,018	41,998
20/10/2018 08:00	4,732	415685,35	0,84	19,136	10747,656	42
20/10/2018 09:00	2,383	413342,847	0,745	20,154	10720,469	42,001
20/10/2018 10:00	2,078	410756,97	0,83	19,871	10704,398	41,999
20/10/2018 11:00	2,021	408705,892	0,818	18,379	10655,092	41,997
20/10/2018 12:00	1,933	407682,933	0,799	17,922	10622,109	41,999
20/10/2018 13:00	1,931	409375,763	0,873	16,832	10594,441	42,003
20/10/2018 14:00	1,894	410475,74	0,86	15,865	10570,92	41,999
20/10/2018 15:00	1,838	409808,524	0,858	15,511	10566,805	41,997
20/10/2018 16:00	1,846	410106,552	0,857	15,869	10573,152	42,003
20/10/2018 17:00	1,91	411222,951	0,855	16,514	10573,922	42,003
20/10/2018 18:00	2,749	412836,554	0,854	16,999	10594,471	41,999
20/10/2018 19:00	1,93	409863,624	0,845	19,989	10650,163	41,998
20/10/2018 20:00	1,978	411299,129	0,859	20,928	10662,175	41,999
20/10/2018 21:00	2,055	412804,15	0,859	20,857	10653,273	41,998
20/10/2018 22:00	2,161	413326,928	0,868	20,666	10637,636	41,996
20/10/2018 23:00	2,331	426604,556	0,881	18,119	11058,038	44,258
21/10/2018 00:00	2,995	430499,825	0,852	17,295	11198,899	45,002
21/10/2018 01:00	2,014	430232,983	0,867	20,419	11227,987	45,001
21/10/2018 02:00	1,925	430347,562	0,861	19,691	11240,447	44,995

21/10/2018 03:00	2,053	430891,4	0,863	21,838	11238,11	45
21/10/2018 04:00	2,171	431058,442	0,864	21,914	11251,625	44,999
21/10/2018 05:00	1,974	430805,033	0,869	21,126	11267,115	45,002
21/10/2018 06:00	3,58	425617,581	0,843	21,27	11125,494	44,283
21/10/2018 07:00	21,065	403425,026	0,903	17,378	10289,052	40,069
21/10/2018 08:00	8,417	405908,667	0,884	19,136	10427,892	40,884
21/10/2018 09:00	2,155	411009,229	0,785	20,539	10668,097	42
21/10/2018 10:00	2,077	409424,245	0,865	20,013	10665,695	42,001
21/10/2018 11:00	2,023	406417,044	0,865	17,754	10671,174	41,999
21/10/2018 12:00	1,961	407511,461	0,858	16,562	10659,052	42,001
21/10/2018 13:00	1,883	407311,496	0,858	15,505	10646,507	42,001
21/10/2018 14:00	1,834	407058,677	0,887	15,507	10632,914	41,999
21/10/2018 15:00	1,82	407251,148	0,878	15,556	10633,967	41,999
21/10/2018 16:00	1,828	408324,388	0,883	15,881	10641,234	42,002
21/10/2018 17:00	1,838	408576,027	0,882	15,846	10640,572	42,001
21/10/2018 18:00	1,902	409401,177	0,887	16,553	10637,845	42
21/10/2018 19:00	2,276	410648,585	0,898	17,453	10653,658	42,003
21/10/2018 20:00	2,672	412043,76	0,896	17,148	10673,507	42
21/10/2018 21:00	3,454	412416,972	0,916	16,769	10680,688	42
21/10/2018 22:00	2,627	420744,496	0,912	16,098	10932,211	43,431
21/10/2018 23:00	1,939	430389,746	0,907	14,912	11270,72	45
22/10/2018 00:00	1,83	428521,594	0,911	15,186	11270,14	44,995
22/10/2018 01:00	1,868	428689,386	0,9	15,407	11275,232	45,001
22/10/2018 02:00	2,122	429357,85	0,897	16,251	11286,39	44,999
22/10/2018 03:00	2,32	429651,644	0,89	17,254	11282,843	45
22/10/2018 04:00	2,046	429805,117	0,905	16,37	11291,339	45,002
22/10/2018 05:00	3,139	430018,307	0,908	17,368	11268,873	45,002
22/10/2018 06:00	3,148	430126,44	0,858	17,373	11291,446	45
22/10/2018 07:00	1,929	430074,653	0,869	15,889	11689,966	46,893
22/10/2018 08:00	1,956	430400,192	0,865	16,226	11692,089	47,001
22/10/2018 09:00	1,85	429716,026	0,786	16,15	11671,869	46,999
22/10/2018 10:00	1,833	429350,391	0,849	16,442	11614,358	46,77
22/10/2018 11:00	1,839	429813,32	0,86	16,514	11504,283	46,217
22/10/2018 12:00	1,821	429082,215	0,861	16,282	11328,964	45,429
22/10/2018 13:00	1,776	430641,866	0,817	16,421	11384,952	45,707
22/10/2018 14:00	1,769	430640,473	0,814	16,47	11341,706	45,5
22/10/2018 15:00	1,783	429668,484	0,813	16,454	11272,76	45,173
22/10/2018 16:00	1,778	428119,655	0,81	16,297	11195,075	44,826
22/10/2018 17:00	1,777	429249,84	0,812	16,373	11221,42	44,96
22/10/2018 18:00	1,774	431295,287	0,803	16,506	11380,026	45,696
22/10/2018 19:00	1,79	430815,036	0,8	16,708	11577,916	46,52
22/10/2018 20:00	1,801	429941,048	0,806	16,696	11661,625	46,827
22/10/2018 21:00	1,793	430635,035	0,822	16,235	11701,3	47,002
22/10/2018 22:00	1,786	431417,032	0,825	16,281	11704,829	46,999
22/10/2018 23:00	1,821	430980,726	0,822	16,356	11705,87	46,997
23/10/2018 00:00	1,928	429837,246	0,813	16,071	11705,923	46,999
23/10/2018 01:00	1,833	430169,973	0,846	15,991	11708,274	47
23/10/2018 02:00	1,777	430486,657	0,845	15,869	11702,389	46,998
23/10/2018 03:00	1,797	429968,447	0,842	15,591	11694,748	46,999
23/10/2018 04:00	1,805	429490,438	0,84	15,524	11697,396	46,999
23/10/2018 05:00	1,898	429714,129	0,854	15,486	11686,214	47,005
23/10/2018 06:00	1,755	430096,464	0,812	17,631	11708,909	47
23/10/2018 07:00	1,854	430613,077	0,831	17,631	11710,953	46,993
23/10/2018 08:00	1,85	430653,172	0,826	17,631	11695,242	46,999
23/10/2018 09:00	1,858	433368,233	0,744	17,631	11661,778	46,969
23/10/2018 10:00	1,799	433260,789	0,807	17,631	11607,268	46,741
23/10/2018 11:00	1,775	433401,217	0,809	17,631	11480,297	46,129
23/10/2018 12:00	6,385	433616,556	0,747	17,631	11456,661	46,04
23/10/2018 13:00	144,25	437990,067	0,513	17,631	11473,107	46,138
23/10/2018 14:00	1,68	441498,443	0,821	17,631	11598,361	46,703
23/10/2018 15:00	1,734	433763,399	0,824	17,631	11680,904	47,131
23/10/2018 16:00	1,684	431574,318	0,801	17,631	12028,424	48,918
23/10/2018 17:00	1,713	430576,682	0,802	17,631	11850,027	47,707
23/10/2018 18:00	1,724	430560,913	0,797	17,631	11832,312	47,701
23/10/2018 19:00	1,748	430006,39	0,817	16,22	11826,25	47,699
23/10/2018 20:00	1,777	430701,18	0,819	16,103	11829,044	47,699
23/10/2018 21:00	1,768	431783,64	0,824	15,608	11831,035	47,702
23/10/2018 22:00	1,855	432181,833	0,824	15,676	11832,257	47,698
23/10/2018 23:00	3,414	431894,658	0,842	16,787	11345,141	45,333
24/10/2018 00:00	3,105	426792,234	0,843	18,583	11294,171	45,003
24/10/2018 01:00	1,977	431615,756	0,852	19,712	11316,034	44,999
24/10/2018 02:00	1,993	431394,583	0,838	20,456	11319,256	44,997
24/10/2018 03:00	2,046	430881,478	0,851	19,679	11318,902	45,001
24/10/2018 04:00	1,975	430309,882	0,852	19,634	11321,008	45
24/10/2018 05:00	1,974	430301,766	0,852	20,349	11302,511	45,001
24/10/2018 06:00	2,18	418731,409	0,821	17,712	11319,846	45
24/10/2018 07:00	2,001	432497,717	0,847	17,621	11331,701	45,001
24/10/2018 08:00	2,055	419507,287	0,846	17,712	11063,84	43,616
24/10/2018 09:00	1,963	420570,452	0,845	17,712	11004,108	43,494
24/10/2018 10:00	1,949	419300,875	0,847	17,712	10975,609	43,504
24/10/2018 11:00	1,914	420229,258	0,839	17,712	10961,478	43,558
24/10/2018 12:00	1,791	420014,583	0,842	17,712	11006,392	43,8
24/10/2018 13:00	1,801	419019,995	0,839	17,712	11005,048	43,797
24/10/2018 14:00	1,805	418641,239	0,804	17,712	11005,412	43,796
24/10/2018 15:00	1,81	420288,639	0,806	17,712	11005,902	43,803
24/10/2018 16:00	1,814	422460,707	0,806	17,712	11025,221	43,801
24/10/2018 17:00	1,811	422754,491	0,807	17,712	11036,041	43,793
24/10/2018 18:00	1,84	420136,839	0,812	17,712	11040,628	43,8
24/10/2018 19:00	1,848	425842,309	0,813	15,12	11047,27	43,802
24/10/2018 20:00	1,919	426439,392	0,808	15,677	11048,908	43,801
24/10/2018 21:00	2,067	428094,263	0,833	16,142	11049,447	43,799
24/10/2018 22:00	2,3	429027,558	0,832	16,729	11048,873	43,799
24/10/2018 23:00	2,864	429998,135	0,837	16,707	11049,768	43,797
25/10/2018 00:00	3,211	425275,273	0,825	16,66	11043,289	43,801
25/10/2018 01:00	3,988	429366,33	0,844	16,459	11044,105	43,8
25/10/2018 02:00	3,094	423518,109	0,834	18,293	10942,691	43,258
25/10/2018 03:00	2,408	414231,739	0,835	20,244	10715,551	42,001
25/10/2018 04:00	6,326	408916,613	0,851	19,4	10539,078	40,997
25/10/2018 05:00	14,811	403592,767	0,846	18,098	10295,257	39,998
25/10/2018 06:00	12,832	390311,765	0,811	13,592	10309,651	39,999
25/10/2018 07:00	8,348	388199,649	0,85	13,592	10319,247	39,999
25/10/2018 08:00	4,099	419597,434	0,847	17,701	10313,346	40,001

25/10/2018 09:00	2,664	391109,508	0,825	13,592	10301,486	39,999
25/10/2018 10:00	2,286	426049,035	0,829	17,701	10298,65	40,006
25/10/2018 11:00	2,186	419949,318	0,834	17,701	10300,233	40,002
25/10/2018 12:00	2,123	385968,905	0,827	13,592	10263,689	39,802
25/10/2018 13:00	2,107	387720,192	0,819	13,592	10204,686	39,411
25/10/2018 14:00	103,317	423081,919	0,778	17,701	10294,434	40,001
25/10/2018 15:00	2,053	391355,192	0,911	13,592	10299,34	39,999
25/10/2018 16:00	2,066	390702,978	0,913	13,592	10312,178	39,998
25/10/2018 17:00	2,043	423203,436	0,907	17,701	10315,068	40,001
25/10/2018 18:00	2,099	423609,55	0,908	17,701	10319,029	40,001
25/10/2018 19:00	2,352	397150,929	0,911	19,711	10320,252	40
25/10/2018 20:00	2,884	398276,975	0,915	19,327	10321,486	39,998
25/10/2018 21:00	3,982	399354,465	0,908	18,932	10326,885	39,999
25/10/2018 22:00	5,732	400053,558	0,906	18,547	10325,489	40,002
25/10/2018 23:00	8,395	401108,102	0,919	18,24	10322,064	39,999
26/10/2018 00:00	11,088	398623,901	0,914	18,229	10318,047	39,999
26/10/2018 01:00	12,078	402251,416	0,94	18,057	10323,75	40
26/10/2018 02:00	12,266	401995,764	0,935	17,989	10322,278	40
26/10/2018 03:00	18,355	403059,93	0,945	17,62	10319,983	40,001
26/10/2018 04:00	21,032	402984,43	0,952	17,465	10320,564	40,001
26/10/2018 05:00	18,528	403335,27	0,954	17,502	10316,767	39,995
26/10/2018 06:00	17,385	302410,546	0,925	17,677	10328,508	40,001
26/10/2018 07:00	11,444	401808,889	0,945	17,898	10328,677	40,004
26/10/2018 08:00	5,57	400264,654	0,934	18,566	10315,459	40,003
26/10/2018 09:00	2,446	398114,737	0,823	19,837	10304,859	40,001
26/10/2018 10:00	2,242	395785,263	0,911	20,658	10290,265	39,997
26/10/2018 11:00	2,238	393828,317	0,917	20,189	10281,934	39,999
26/10/2018 12:00	2,061	391553,445	0,909	18,126	10280,062	40,003
26/10/2018 13:00	2,037	391912,699	0,913	17,961	10253,708	40
26/10/2018 14:00	2,043	394040,8	0,89	17,76	10226,387	40,003
26/10/2018 15:00	1,995	393688,511	0,803	17,594	10222,165	39,998
26/10/2018 16:00	1,992	394380,773	0,802	17,533	10215,383	39,998
26/10/2018 17:00	2,012	395044,492	0,798	17,349	10224,648	40
26/10/2018 18:00	2,4	396983,309	0,794	17,323	10257,145	39,999
26/10/2018 19:00	3,606	396629,036	0,795	17,418	10279,289	40,002
26/10/2018 20:00	2,07	394667,074	0,799	20,431	10314,628	39,999
26/10/2018 21:00	2,191	396331,634	0,804	21,014	10310,016	40
26/10/2018 22:00	2,218	396569,492	0,821	20,685	10313,78	39,999
26/10/2018 23:00	2,301	397594,215	0,819	20,32	10306,192	40,001
27/10/2018 00:00	2,555	394458,98	0,824	19,889	10304,079	39,998
27/10/2018 01:00	2,746	398506,183	0,83	19,721	10300,172	40,001
27/10/2018 02:00	2,5	397787,147	0,825	19,821	10293,727	39,998
27/10/2018 03:00	2,732	398467,233	0,806	19,654	10292,409	40,005
27/10/2018 04:00	2,976	399013,456	0,809	19,474	10289,31	39,998
27/10/2018 05:00	2,658	398167,37	0,817	19,634	10301,851	39,996
27/10/2018 06:00	5,302	400296,672	0,774	18,685	10297,374	39,997
27/10/2018 07:00	3,144	418734,602	0,784	16,221	10886,389	43,004
27/10/2018 08:00	1,896	430983,123	0,792	14,833	11283,823	44,998
27/10/2018 09:00	2,004	426970,646	0,744	15,96	11343,196	45,324
27/10/2018 10:00	1,942	431497,164	0,782	17,45	11693,71	47
27/10/2018 11:00	1,946	431722,801	0,769	17,483	11681,768	47,003
27/10/2018 12:00	1,905	431011,934	0,78	17,459	11678,729	46,999
27/10/2018 13:00	1,891	430830,215	0,778	17,509	11675,544	47,001
27/10/2018 14:00	1,836	428579,116	0,784	16,42	11382,445	45,516
27/10/2018 15:00	1,796	427456,247	0,785	15,744	11186,306	44,801
27/10/2018 16:00	1,792	429112,765	0,779	15,74	11241,511	44,963
27/10/2018 17:00	1,784	429370,744	0,782	15,678	11258,149	44,994
27/10/2018 18:00	1,785	429590,848	0,779	15,435	11268,362	45,001
27/10/2018 19:00	1,954	412875,093	0,791	15,315	10771,023	42,541
27/10/2018 20:00	1,868	416667,396	0,783	14,125	10888,602	42,998
27/10/2018 21:00	1,922	417421,036	0,784	14,012	10899,057	42,998
27/10/2018 22:00	2,109	418245,76	0,804	14,727	10901,105	42,995
27/10/2018 23:00	2,779	419929,618	0,807	15,795	10900,143	43,001
28/10/2018 00:00	3,555	416471,862	0,806	16,011	10898,101	43,001
28/10/2018 01:00	4,045	420835,388	0,84	15,894	10892,792	43,004
28/10/2018 02:00	4,681	421084,443	0,828	15,797	10893,294	42,999
28/10/2018 03:00	3,749	422420,309	0,834	15,585	10982,889	43,382
28/10/2018 04:00	2,02	428970,355	0,831	14,312	11300,166	44,999
28/10/2018 05:00	1,985	429080,373	0,824	14,47	11288,848	44,999
28/10/2018 06:00	1,861	429352,669	0,78	14,273	11290,679	45,002
28/10/2018 07:00	1,842	428782,151	0,805	14,211	11294,152	45
28/10/2018 08:00	1,897	429106,491	0,811	14,452	11283,645	45,002
28/10/2018 09:00	1,906	427127,752	0,716	15,56	11348,027	45,352
28/10/2018 10:00	1,905	429604,163	0,789	17,345	11693,007	47,002
28/10/2018 11:00	1,874	430022,907	0,775	17,455	11702,533	46,999
28/10/2018 12:00	1,88	430382,274	0,766	17,397	11691,342	46,999
28/10/2018 13:00	1,876	430425,048	0,767	17,862	11677,157	46,949
28/10/2018 14:00	1,853	430410,823	0,761	17,881	11686,346	46,984
28/10/2018 15:00	1,842	430144,895	0,765	17,589	11707,415	46,996
28/10/2018 16:00	1,835	429731,898	0,762	17,59	11716,67	47
28/10/2018 17:00	1,811	429029,317	0,772	15,447	11280,599	44,995
28/10/2018 18:00	1,784	429559,419	0,764	15,23	11293,316	44,997
28/10/2018 19:00	1,809	430456,501	0,78	15,162	11331,866	45,201
28/10/2018 20:00	1,809	431399,328	0,774	15,522	11503,918	46
28/10/2018 21:00	1,849	431302,235	0,787	15,442	11511,217	45,997
28/10/2018 22:00	1,857	431517,859	0,788	15,221	11503,167	45,999
28/10/2018 23:00	1,905	431023,492	0,789	14,784	11499,955	46,001
29/10/2018 00:00	1,938	426951,776	0,778	14,775	11497,391	45,997
29/10/2018 01:00	1,901	430641,827	0,787	14,698	11499,398	46,001
29/10/2018 02:00	1,902	430668,525	0,797	14,624	11493,769	46,006
29/10/2018 03:00	1,853	431069,915	0,79	14,287	11488,94	46,001
29/10/2018 04:00	1,896	430486,522	0,792	14,336	11488,639	45,998
29/10/2018 05:00	1,927	430786,446	0,816	14,316	11482,35	46,002
29/10/2018 06:00	2,068	413665,036	0,79	18,048	10803,79	42,374
29/10/2018 07:00	1,987	429880,83	0,802	14,893	11405,417	45,571
29/10/2018 08:00	3,187	423642,955	0,783	14,634	11251,363	44,642
29/10/2018 09:00	20,57	356147,388	0,755	11,716	8977,433	33,115
29/10/2018 10:00	27,799	350196,413	0,861	12,256	8783,169	32,132
29/10/2018 11:00	22,031	348884,221	0,842	12,539	8740,052	31,998
29/10/2018 12:00	15,511	348468,994	0,834	12,676	8735,127	32,004
29/10/2018 13:00	138,708	348233,529	0,721	11,653	8729,973	32,004
29/10/2018 14:00	101,993	348323,825	0,717	14,147	8733,675	32,003

29/10/2018 15:00	17,971	363153,805	0,911	13,72	9174,852	34,359
29/10/2018 16:00	1,537	402994,86	0,863	18,669	10512,091	41,001
29/10/2018 17:00	22,367	360137,456	0,904	12,827	9109,972	33,828
29/10/2018 18:00	25,819	355585,209	0,916	11,783	8940,731	32,999
29/10/2018 19:00	9,81	410306,674	0,881	14,578	10525,66	41,186
29/10/2018 20:00	2,931	429478,455	0,873	15,255	11092,683	43,998
29/10/2018 21:00	4,516	429415,853	0,877	15,103	11096,738	44
29/10/2018 22:00	2,466	430017,908	0,871	14,387	11331,84	45,212
29/10/2018 23:00	1,333	431342,921	0,849	13,751	11505,469	46,001
30/10/2018 00:00	1,42	426733,759	0,837	14,268	11500,908	46
30/10/2018 01:00	1,691	430068,229	0,861	15,382	11493,037	46,002
30/10/2018 02:00	1,835	429201,844	0,85	15,686	11491,578	45,995
30/10/2018 03:00	2,06	429761,834	0,829	15,927	11492,414	45,995
30/10/2018 04:00	1,97	430313,986	0,825	15,986	11493,273	46
30/10/2018 05:00	1,976	430612,198	0,857	16,085	11483,236	45,997
30/10/2018 06:00	2,017	429926,181	0,799	15,937	11500,687	46,002
30/10/2018 07:00	1,804	429354,011	0,833	15,296	11515,123	46,003
30/10/2018 08:00	1,893	429845,084	0,84	15,365	11510,102	46,038
30/10/2018 09:00	1,673	429344,285	0,746	14,475	11491,187	46,092
30/10/2018 10:00	14,849	399337,723	0,854	13,314	10411,282	40,505
30/10/2018 11:00	19,013	355623,846	0,902	11,964	8936,433	33,002
30/10/2018 12:00	9,175	352989,953	0,899	12,323	8938,399	32,998
30/10/2018 13:00	8,214	353266,996	0,92	12,443	8923,163	33,005
30/10/2018 14:00	7,346	353492,96	0,9	12,434	8929,984	32,999
30/10/2018 15:00	7,281	353416,057	0,913	12,469	8947,297	32,998
30/10/2018 16:00	5,55	353893,845	0,915	12,75	8932,826	32,999
30/10/2018 17:00	7,393	353473,262	0,914	12,428	8949,935	33
30/10/2018 18:00	4,439	372530,759	0,889	14,491	9674,842	36,438
30/10/2018 19:00	1,448	407459,663	0,859	15,186	10771,496	42,151
30/10/2018 20:00	1,312	430667,674	0,831	15,071	11531,987	46,001
30/10/2018 21:00	1,287	430226,22	0,837	14,303	11540,823	46
30/10/2018 22:00	1,313	430648,839	0,832	14,062	11539,39	45,999
30/10/2018 23:00	1,298	430762,174	0,846	13,716	11542,732	46,002
31/10/2018 00:00	1,325	427434,919	0,833	13,609	11556,654	46,004
31/10/2018 01:00	1,354	430291,635	0,849	13,703	11550,289	45,998
31/10/2018 02:00	1,454	430210,602	0,831	14,182	11540,093	46,002
31/10/2018 03:00	1,364	430406,998	0,842	13,593	11531,882	46
31/10/2018 04:00	1,392	430604,561	0,855	13,511	11521,459	46,003
31/10/2018 05:00	1,553	430387,62	0,873	14,031	11508,578	45,998
31/10/2018 06:00	1,535	430259,699	0,833	14,25	11515,882	46,001
31/10/2018 07:00	1,424	430172,048	0,859	13,712	11523,927	45,995
31/10/2018 08:00	236,764	209216,792	1,154	9,805	6314,275	19,322
31/10/2018 09:00		0	0	0,579	0	0
31/10/2018 10:00		0	0	0,075	0	0
31/10/2018 11:00		0	0	0,047	0	0
31/10/2018 12:00		0	0	0,029	0	0
31/10/2018 13:00		0	16,747	0,283	586,574	1,107
31/10/2018 14:00	74,884	343019,321	26,097	15,533	9993,318	38,88
31/10/2018 15:00	1,371	428500,569	0,782	16,084	11260,057	45,078
31/10/2018 16:00	1,341	429353,4	0,785	16,004	11362,418	45,537
31/10/2018 17:00	1,341	429153,942	0,771	15,999	11467,779	45,951
31/10/2018 18:00	1,321	430110,862	0,773	15,448	11498,8	45,996
31/10/2018 19:00	1,335	429768,359	0,778	15,376	11523,351	45,998
31/10/2018 20:00	1,314	429777,8	0,77	14,876	11536,201	46
31/10/2018 21:00	1,32	430129,883	0,772	14,453	11552,248	46
31/10/2018 22:00	1,34	429468,448	0,78	14,337	11541,685	46
31/10/2018 23:00	1,366	428849,187	0,775	14,099	11528,446	46,001
01/11/2018 00:00	1,41	425408,948	0,765	14,202	11525,157	45,999
01/11/2018 01:00	1,404	429021,035	0,791	14,006	11535,396	46
01/11/2018 02:00	7,592	393273,115	0,825	14,463	10240,69	39,109
01/11/2018 03:00	35,341	364247,107	0,87	10,97	9174,627	34
01/11/2018 04:00	37,595	364295,668	0,88	10,948	9171,737	33,995
01/11/2018 05:00	33,522	364370,254	0,88	10,978	9173,853	34,002
01/11/2018 06:00	33,021	363789,144	0,838	10,935	9173,091	33,998
01/11/2018 07:00	31,386	363886,155	0,869	11,019	9164,574	34,007
01/11/2018 08:00	41,127	363749,851	0,87	11,844	9136,133	33,833
01/11/2018 09:00	2,673	398228,053	0,798	15,168	10425,15	40,324
01/11/2018 10:00	1,657	397150,156	0,835	15,093	10367,599	40,138
01/11/2018 11:00	1,684	392221,556	0,826	15,07	10245,948	39,516
01/11/2018 12:00	1,65	392732,563	0,824	15,055	10250,284	39,622
01/11/2018 13:00	1,69	393191,149	0,816	14,937	10287,555	39,709
01/11/2018 14:00	1,692	389359,02	0,84	14,983	10175,302	39,174
01/11/2018 15:00	1,67	387289,195	0,778	14,755	10127,524	38,921
01/11/2018 16:00	1,662	385843,429	0,787	14,888	10089,433	38,711
01/11/2018 17:00	1,706	388074,811	0,783	14,73	10143,202	39,012
01/11/2018 18:00	1,691	389828,266	0,775	14,395	10212,196	39,309
01/11/2018 19:00	1,66	407572,499	0,767	15,093	10856,553	42,708
01/11/2018 20:00	1,642	429186,906	0,766	15,015	11515,164	46
01/11/2018 21:00	1,55	429110,565	0,758	15,177	11506,396	45,999
01/11/2018 22:00	1,573	429202,411	0,755	15,198	11497,522	46,007
01/11/2018 23:00	1,506	429841,095	0,763	14,378	11492,456	46,003
02/11/2018 00:00	1,426	427849,191	0,738	14,094	11482,052	45,997
02/11/2018 01:00	1,405	429737,446	0,755	14,869	11479,008	46,001
02/11/2018 02:00	1,372	429135,683	0,77	14,853	11482,65	45,998
02/11/2018 03:00	1,384	429423,364	0,766	14,49	11480,784	45,998
02/11/2018 04:00	1,415	429370,227	0,75	15,405	11474,369	45,999
02/11/2018 05:00	1,492	429063,465	0,752	15,77	11477,363	45,999
02/11/2018 06:00	1,498	428808,167	0,728	15,653	11475,734	45,989
02/11/2018 07:00	1,499	428360,651	0,76	15,691	11471,727	45,998
02/11/2018 08:00	1,354	428506,295	0,747	15,122	11474,796	46,006
02/11/2018 09:00	1,387	428613,331	1,217	15,268	11468,974	45,997
02/11/2018 10:00	1,362	428572,382	0,737	15,399	11464,791	46
02/11/2018 11:00	1,394	428372,412	0,742	15,826	11456,111	45,996
02/11/2018 12:00	1,351	428664,863	0,748	15,622	11455,62	46,004
02/11/2018 13:00	1,355	429724,474	0,745	15,602	11457,571	46,002
02/11/2018 14:00	1,331	430100,656	0,749	15,406	11436,852	45,996
02/11/2018 15:00	1,454	405479,562	0,817	15,099	10664,063	41,952
02/11/2018 16:00	1,616	383097,967	0,82	14,871	9939,469	38,243
02/11/2018 17:00	1,596	385992,316	0,815	14,755	10044,247	38,707
02/11/2018 18:00	1,556	391471,857	0,811	14,806	10214,708	39,491
02/11/2018 19:00	1,41	417384,647	0,811	14,631	11080,538	43,791
02/11/2018 20:00	1,335	429249,345	0,794	13,899	11514,849	45,996

02/11/2018 21:00	1,378	429737,218	0,798	13,985	11522,5	46,002
02/11/2018 22:00	1,487	429641,409	0,791	14,438	11518,903	45,999
02/11/2018 23:00	9,711	405655,102	0,834	13,045	10727,901	41,641
03/11/2018 00:00	42,683	363063,03	0,874	11,111	9177,033	34
03/11/2018 01:00	49,016	364698,694	0,892	11,039	9171,2	34
03/11/2018 02:00	50,422	364804,383	0,876	10,974	9172,929	34,001
03/11/2018 03:00	46,575	364866,412	0,875	10,961	9171,416	34,001
03/11/2018 04:00	43,717	364819,618	0,879	10,953	9170,359	34,002
03/11/2018 05:00	49,05	365424,68	0,884	10,893	9188,423	34,003
03/11/2018 06:00	50,068	365071,011	0,835	10,964	9201,233	33,997
03/11/2018 07:00	31,424	372077,475	0,86	11,82	9454,959	35,439
03/11/2018 08:00	1,575	396211,322	0,832	14,737	10468,76	40,238
03/11/2018 09:00	1,634	390710,539	1,137	14,82	10236,922	39,375
03/11/2018 10:00	1,655	381370,22	0,829	15,054	9946,225	38,133
03/11/2018 11:00	1,675	372664,725	0,826	15,581	9715,438	37,017
03/11/2018 12:00	1,712	368596,153	0,839	15,694	9681,863	36,621
03/11/2018 13:00	1,712	365278,717	0,843	15,824	9526,479	36,136
03/11/2018 14:00	1,714	363980,427	0,846	16,073	9415,338	35,778
03/11/2018 15:00	1,518	401802,502	0,797	15,782	10467,393	41,261
03/11/2018 16:00	1,436	414575,5	0,786	15,373	10809,013	42,998
03/11/2018 17:00	1,412	415756,087	0,785	14,877	10868,404	43
03/11/2018 18:00	1,421	416827,695	0,785	14,464	10895,23	43,001
03/11/2018 19:00	1,577	418282,832	0,783	15,5	10910,601	43,002
03/11/2018 20:00	1,85	419666,215	0,798	16,208	10875,467	43,001
03/11/2018 21:00	3,145	421511,238	0,802	16,401	10874,823	42,998
03/11/2018 22:00	2,899	420359,476	0,809	16,984	10881,445	42,999
03/11/2018 23:00	1,664	418264,942	0,806	18,784	10918,287	42,997
04/11/2018 00:00	1,754	414868,472	0,804	20,591	10929,111	43
04/11/2018 01:00	1,753	417539,222	0,815	20,545	10914,175	42,999
04/11/2018 02:00	1,865	418134,659	0,815	20,523	10919,473	42,995
04/11/2018 03:00	1,875	418946,041	0,819	20,451	10924,49	43,002
04/11/2018 04:00	2,421	419969,355	0,814	20,171	10929,94	42,999
04/11/2018 05:00	32,658	383549,297	0,847	13,74	9819,293	37,065
04/11/2018 06:00	39,412	370621,565	0,815	11,591	9387,968	35,004
04/11/2018 07:00	22,003	369759,221	0,84	11,94	9357,45	34,999
04/11/2018 08:00	3,06	420710,973	0,787	15,291	11366,635	45,436
04/11/2018 09:00	1,403	428316,914	0,999	15,657	11669,987	47,003
04/11/2018 10:00	1,383	427997,736	0,748	15,477	11658,103	47
04/11/2018 11:00	1,381	427787,016	0,754	15,622	11623,719	46,914
04/11/2018 12:00	1,365	427966,12	0,768	15,729	11540,757	46,509
04/11/2018 13:00	1,371	428675,777	0,77	15,801	11435,327	46,064
04/11/2018 14:00	1,378	429500,391	0,779	15,871	11329,94	45,629
04/11/2018 15:00	1,388	428688,794	0,817	15,784	11226,092	45,147
04/11/2018 16:00	1,401	428810,725	0,79	15,911	11183,566	45,047
04/11/2018 17:00	1,386	429420,591	0,797	16,012	11230,912	45,307
04/11/2018 18:00	1,359	429934,154	0,779	16,069	11418,371	46,12
04/11/2018 19:00	1,342	429341,287	0,772	15,872	11633,954	46,943
04/11/2018 20:00	1,353	428886,951	0,774	15,805	11675,077	46,998
04/11/2018 21:00	2,794	406667,883	0,806	18,055	10665,547	41,75
04/11/2018 22:00	4,628	399755,815	0,821	18,695	10283,775	40,001
04/11/2018 23:00	5,637	400777,778	0,822	18,476	10263,861	40,002
05/11/2018 00:00	7,303	399850,767	0,806	18,366	10254,61	40,002
05/11/2018 01:00	10,415	402088,606	0,828	18,248	10251,452	40,001
05/11/2018 02:00	15,607	402914,098	0,842	18,06	10260,089	40,001
05/11/2018 03:00	14,985	403181,138	0,85	18,039	10290,619	40,002
05/11/2018 04:00	16,849	403093,343	0,852	17,812	10316,086	40
05/11/2018 05:00	19,193	403541,071	0,846	17,841	10308,337	39,999
05/11/2018 06:00	37,468	390612,509	0,828	15,679	9816,503	37,388
05/11/2018 07:00	21,82	376023,804	0,861	13,659	9628,614	36,314
05/11/2018 08:00	2,214	388866,844	0,834	15,463	10185,021	39,045
05/11/2018 09:00	3,538	358189,532	1,389	13,36	9072,667	33,997
05/11/2018 10:00	1,888	356373,2	0,841	13,67	9069,425	34
05/11/2018 11:00	1,78	353663,189	0,847	14,148	9103,285	33,998
05/11/2018 12:00	1,723	351579,242	0,854	14,481	9109,618	33,999
05/11/2018 13:00	1,737	350916,021	0,855	15,25	9117,37	34,001
05/11/2018 14:00	1,675	369496,642	0,859	16,093	9585,034	36,664
05/11/2018 15:00	1,446	415925,753	0,835	15,612	10889,271	43,411
05/11/2018 16:00	1,45	413716,921	0,844	15,69	10815,288	43,146
05/11/2018 17:00	1,451	415207,847	0,842	15,681	10864,783	43,387
05/11/2018 18:00	1,463	419862,174	0,838	15,739	11044,344	43,977
05/11/2018 19:00	22,821	337290,809	0,919	14,484	8509,973	30,682
05/11/2018 20:00	43,678	335782,392	0,915	14,464	8389,207	30,004
05/11/2018 21:00	51,821	336681,994	0,936	14,472	8401,075	30,004
05/11/2018 22:00	26,766	359928,354	0,941	16,045	9133,922	33,959
05/11/2018 23:00	1,707	395174,155	0,896	21,434	10346,895	40,005
06/11/2018 00:00	26,673	348650,639	0,937	14,466	8878,255	32,537
06/11/2018 01:00	35,08	348604,945	0,952	13,744	8789,715	32,003
06/11/2018 02:00	40,104	349153,336	0,952	13,664	8797,151	31,997
06/11/2018 03:00	45,92	349812,394	0,954	13,672	8806,926	32,002
06/11/2018 04:00	47,401	350053,657	0,947	13,656	8789,725	32,004
06/11/2018 05:00	32,582	363280,26	0,93	14,825	9198,544	34,239
06/11/2018 06:00	2,426	416130,996	0,859	17,951	10850,72	42,709
06/11/2018 07:00	4,084	369670,398	0,898	13,911	9550,103	35,619
06/11/2018 08:00	22,553	345017,556	0,913	13,245	8791,533	31,786
06/11/2018 09:00	18,656	338361,699	1,557	13,098	8636,465	31
06/11/2018 10:00	9,908	336708,573	0,898	13,209	8617,008	30,937
06/11/2018 11:00	4,259	334694,431	0,91	13,845	8618,181	30,998
06/11/2018 12:00	2,083	331858,324	0,907	15,396	8590,908	31
06/11/2018 13:00	23,397	320082,369	0,943	16,194	8157,201	28,765
06/11/2018 14:00	28,793	316465,577	0,961	16,267	8015,497	28,004
06/11/2018 15:00	24,836	316538,096	0,606	16,472	8008,411	28
06/11/2018 16:00	25,555	317255,426	0,876	16,084	7991,231	28
06/11/2018 17:00	33,832	318458,025	0,879	15,607	8013,427	27,996
06/11/2018 18:00	42,268	321443,519	0,88	15,231	8090,403	28,217
06/11/2018 19:00	16,629	332011,917	0,868	13,654	8466,065	29,997
06/11/2018 20:00	26,115	333597,973	0,869	13,644	8467,943	30,002
06/11/2018 21:00	34,731	334499,448	0,877	13,673	8478,404	30,003
06/11/2018 22:00	19,566	344219,026	0,878	13,177	8811,426	31,573
06/11/2018 23:00	21,021	348321,217	0,883	13,044	8879,552	32
07/11/2018 00:00	19,881	346500,005	0,864	13,078	8864,801	31,997
07/11/2018 01:00	21,06	347845,488	0,892	13,07	8871,585	31,998
07/11/2018 02:00	23,818	348276,068	0,895	13,151	8862,839	32,003

07/11/2018 03:00	31,544	348553,056	0,88	13,188	8862,396	31,999
07/11/2018 04:00	30,738	348495,094	0,884	13,322	8859,186	31,998
07/11/2018 05:00	38,324	308376,965	0,514	13,484	8846,746	31,998
07/11/2018 06:00	39,16	263126,503	0,134	13,411	8880,906	32
07/11/2018 07:00	22,091	263656,332	0,14	13,353	8862,733	32,004
07/11/2018 08:00	21,979	259350,62	0,148	13,645	8660,186	31,13
07/11/2018 09:00	36,752	249722,576	3,489	14,493	8287,882	29,314
07/11/2018 10:00	28,772	303921,707	9,511	14,825	8200,889	28,995
07/11/2018 11:00	18,775	252747,106	60,944	15,075	8182,349	29
07/11/2018 12:00	11,41	240826,034	67,684	15,408	8178,949	29,001
07/11/2018 13:00	10,897	250342,989	58,283	16,015	8113,541	28,728
07/11/2018 14:00	31,331	315568,36	0,906	17,97	7994,288	28,151
07/11/2018 15:00	18,687	333817,458	0,852	21,011	8565,914	31,038
07/11/2018 16:00	31,433	318964,783	0,854	17,853	8017,383	28,278
07/11/2018 17:00	50,895	314138,512	0,866	16,891	7779,378	27,102
07/11/2018 18:00	40,22	321214,089	0,858	15,403	7985,147	28
07/11/2018 19:00	13,183	376726,328	0,803	14,748	9723,491	36,757
07/11/2018 20:00	1,513	410112,975	0,765	14,536	10791,734	42
07/11/2018 21:00	1,589	409858,916	0,759	14,093	10816,7	41,998
07/11/2018 22:00	1,646	416282,453	0,771	14,139	10989,489	42,922
07/11/2018 23:00	1,572	429406,26	0,769	15	11395,381	44,996
08/11/2018 00:00	1,545	427436,054	0,756	14,985	11399,118	45,001
08/11/2018 01:00	1,535	429752,373	0,767	15,094	11405,752	45,002
08/11/2018 02:00	1,464	429559,333	0,764	15,111	11406,101	44,998
08/11/2018 03:00	1,496	429708,794	0,776	15,159	11404,921	45,003
08/11/2018 04:00	1,512	430078,222	0,779	15,011	11404,601	44,996
08/11/2018 05:00	1,549	430383,428	0,788	15,106	11498,898	45,599
08/11/2018 06:00	1,464	430010,053	0,744	15,439	11602,699	45,999
08/11/2018 07:00	1,466	429784,3	0,761	15,234	11610,112	45,999
08/11/2018 08:00	1,502	428997,508	0,763	15,472	11470,463	45,34
08/11/2018 09:00	1,565	424897,966	0,993	15,23	11303,675	44,677
08/11/2018 10:00	1,618	419794,977	0,759	15,066	11152,759	44,006
08/11/2018 11:00	1,576	409832,045	0,765	14,817	10903,669	42,755
08/11/2018 12:00	1,525	405803,956	0,76	15,245	10828,688	42,369
08/11/2018 13:00	1,582	417831,634	0,76	16,994	11158,018	44,063
08/11/2018 14:00	1,555	417730,657	0,76	17,028	11124,088	43,968
08/11/2018 15:00	1,552	419459,955	0,767	17,119	11137,196	44,083
08/11/2018 16:00	1,552	421926,059	0,807	17,272	11164,628	44,192
08/11/2018 17:00	1,543	425908,193	0,815	17,36	11289,593	44,773
08/11/2018 18:00	1,518	430182,096	0,805	17,578	11509,927	45,712
08/11/2018 19:00	1,499	430604,788	0,796	17,337	11609,422	46,002
08/11/2018 20:00	1,502	430672,598	0,799	17,499	11617,733	46,002
08/11/2018 21:00	1,637	430629,541	0,798	17,535	11624,869	46,001
08/11/2018 22:00	1,657	430245,833	0,801	17,762	11893,489	47,408
08/11/2018 23:00	3,175	417486,925	0,824	16,681	11028,649	42,944
09/11/2018 00:00	4,762	415383,129	0,816	16,115	10797,225	42,003
09/11/2018 01:00	5,693	415315,694	0,843	16,004	10796,682	42
09/11/2018 02:00	1,868	403553,82	0,845	17,2	10586,634	40,733
09/11/2018 03:00	1,658	412282,079	0,835	19,029	10829,792	42,001
09/11/2018 04:00	1,642	412389,908	0,847	18,735	10829,459	41,997
09/11/2018 05:00	1,774	412589,816	0,839	19,639	10815,074	42,002
09/11/2018 06:00	1,798	412660,275	0,817	19,402	10825,658	41,999
09/11/2018 07:00	1,665	411003,195	0,838	17,408	10834,111	41,998
09/11/2018 08:00	1,724	410961,224	0,836	16,199	10798,337	41,996
09/11/2018 09:00	1,622	409437,244	1,231	15,029	10765,545	41,997
09/11/2018 10:00	1,605	407720,95	0,827	15,263	10751,437	42,002
09/11/2018 11:00	1,571	406760,78	0,835	15,112	10744,172	41,996
09/11/2018 12:00	1,54	405596,026	0,827	15,152	10738,633	42,001
09/11/2018 13:00	1,529	404373,383	0,828	15,129	10729,2	41,997
09/11/2018 14:00	1,512	405723,841	0,822	15,236	10737,945	42,002
09/11/2018 15:00	1,517	406582,748	0,834	15,358	10734,79	42,001
09/11/2018 16:00	1,528	407930,129	0,819	15,493	10751,854	41,999
09/11/2018 17:00	1,544	410071,684	0,817	15,53	10768,405	42
09/11/2018 18:00	1,553	411369,117	0,823	15,374	10781,224	41,998
09/11/2018 19:00	1,768	413478,879	0,815	16,553	10781,159	42,001
09/11/2018 20:00	3,204	419904,148	0,806	16,707	11175,698	43,957
09/11/2018 21:00	1,414	430366,456	0,78	16,198	11927,732	47,584
09/11/2018 22:00	1,492	429986,809	0,792	16,138	11804,405	46,996
09/11/2018 23:00	1,449	429744,353	0,809	16,155	11810,495	46,997
10/11/2018 00:00	1,718	413172,176	0,817	20,046	11048,112	43,142
10/11/2018 01:00	1,803	414491,949	0,857	21,214	10819,592	41,999
10/11/2018 02:00	1,917	414976,809	0,871	21,096	10805,302	41,999
10/11/2018 03:00	1,931	415329,678	0,863	21,043	10807,206	41,994
10/11/2018 04:00	1,876	415303,235	0,87	21,029	10812,486	42,002
10/11/2018 05:00	1,897	415145,549	0,869	21,007	10822,629	42
10/11/2018 06:00	1,958	414229,284	0,833	21,041	10820,778	42
10/11/2018 07:00	1,767	411504,982	0,838	19,873	10816,141	42
10/11/2018 08:00	1,736	410213,145	0,838	17,507	10807,868	41,996
10/11/2018 09:00	1,712	410643,695	1,471	15,777	10748,517	41,998
10/11/2018 10:00	1,535	408537,244	0,825	15,266	10737,656	42,002
10/11/2018 11:00	1,56	409054,255	0,808	14,884	10739,49	41,996
10/11/2018 12:00	1,523	409174,484	0,818	14,473	10742,576	42,002
10/11/2018 13:00	1,505	409102,641	0,818	14,062	10743,221	42,002
10/11/2018 14:00	1,5	410689,835	0,82	13,991	10730,51	41,997
10/11/2018 15:00	1,499	411454,147	0,823	13,635	10721,066	41,999
10/11/2018 16:00	1,569	412247,292	0,852	13,439	10731,443	41,995
10/11/2018 17:00	1,928	413831,139	0,853	13,964	10745,47	42,001
10/11/2018 18:00	2,878	413501,461	0,861	14,739	10754,115	41,998
10/11/2018 19:00	5,132	413827,358	0,853	15,343	10783,164	41,998
10/11/2018 20:00	1,576	411457,84	0,848	17,019	10814,325	41,999
10/11/2018 21:00	1,63	411929,955	0,851	17,458	10814,429	41,997
10/11/2018 22:00	8,738	393701,185	0,875	15,334	10224,698	38,923
10/11/2018 23:00	59,914	356947,087	0,917	11,985	8957,625	32,599
11/11/2018 00:00	33,004	362951,128	0,903	11,617	9208,23	33,817
11/11/2018 01:00	31,736	363608,374	0,921	11,57	9234,307	33,996
11/11/2018 02:00	32,022	364024,469	0,911	11,666	9230,995	33,996
11/11/2018 03:00	30,016	363757,135	0,928	11,611	9229,193	33,999
11/11/2018 04:00	32,015	363727,557	0,919	11,566	9226,89	34,003
11/11/2018 05:00	37,047	364759,58	0,914	11,662	9228,017	34,001
11/11/2018 06:00	34,356	364969,396	0,887	11,85	9229,118	34,002
11/11/2018 07:00	30,885	364086,296	0,918	11,926	9215,79	34
11/11/2018 08:00	21,964	363153,383	0,91	11,913	9206,761	34

11/11/2018 09:00	14,581	361934,209	1,159	11,864	9200,536	34
11/11/2018 10:00	10,454	362322,763	0,886	12,004	9199,865	33,996
11/11/2018 11:00	5,661	360999,743	0,899	12,472	9195,916	34,002
11/11/2018 12:00	2,629	358853,269	0,901	12,886	9199,322	33,998
11/11/2018 13:00	23,288	348508,337	0,912	12,698	8807,004	31,991
11/11/2018 14:00	29,772	343360,666	0,935	12,563	8591,953	31
11/11/2018 15:00	31,22	344669,984	0,928	12,616	8597,625	30,997
11/11/2018 16:00	30,708	345668,671	0,877	12,658	8591,806	31,001
11/11/2018 17:00	37,985	345983,726	0,871	12,678	8592,699	30,997
11/11/2018 18:00	57,373	346428,182	0,876	12,726	8614,729	30,998
11/11/2018 19:00	12,109	415151,763	0,816	15,181	11088,65	43,474
11/11/2018 20:00	1,386	430982,361	0,792	15,402	11812,297	46,997
11/11/2018 21:00	1,38	430713,502	0,782	14,859	11821,971	47,003
11/11/2018 22:00	22,479	395953,423	0,817	13,178	10466,55	39,978
11/11/2018 23:00	39,9	365691,078	0,86	11,772	9236,927	33,999
12/11/2018 00:00	39,827	365244,728	0,855	11,735	9235,864	34,004
12/11/2018 01:00	41,497	364916,686	0,875	11,726	9237,173	34,002
12/11/2018 02:00	41,987	365180,242	0,868	11,558	9239,128	33,995
12/11/2018 03:00	40,307	365414,69	0,879	11,554	9241,046	34
12/11/2018 04:00	44,736	365319,273	0,881	11,475	9236,985	34,003
12/11/2018 05:00	7,568	418593,406	0,821	17,809	10990,712	42,968
12/11/2018 06:00	1,995	421369,181	0,786	19,911	11027,525	43,002
12/11/2018 07:00	1,99	421327,87	0,813	19,84	11027,36	43,003
12/11/2018 08:00	1,835	421451,624	0,813	20,108	11024,397	42,999
12/11/2018 09:00	1,899	421697,987	1,241	20,034	11028,921	43
12/11/2018 10:00	2,023	421130,242	0,812	20,186	11020,487	43,003
12/11/2018 11:00	1,774	420333,599	0,838	20,207	11017,103	43,003
12/11/2018 12:00	2,042	420918,26	0,845	20,097	11015,288	42,999
12/11/2018 13:00	1,763	419370,231	0,829	19,499	10991,414	42,999
12/11/2018 14:00	25,359	387915,435	0,842	15,336	9981,366	37,811
12/11/2018 15:00	13,022	413378,33	0,834	14,049	10799,797	42,133
12/11/2018 16:00	1,518	431441,564	0,861	14,79	11394,578	45,004
12/11/2018 17:00	1,971	432228,032	0,866	15,304	11408,608	45,002
12/11/2018 18:00	5,954	432659,852	0,878	16,265	11406,1	45
12/11/2018 19:00	1,705	431975,68	0,888	19,885	11435,201	44,999
12/11/2018 20:00	1,585	431138,534	0,888	18,9	11439,846	44,999
12/11/2018 21:00	1,538	430917,19	0,897	18,609	11441,464	44,999
12/11/2018 22:00	1,544	430869,541	0,902	18,955	11446,105	45,001
12/11/2018 23:00	1,575	431047,338	0,901	19,407	11440,17	44,999
13/11/2018 00:00	1,696	430685,833	0,881	18,668	11442,767	44,997
13/11/2018 01:00	1,598	431052,188	0,901	19,66	11440,554	44,997
13/11/2018 02:00	4,992	400381,462	0,925	14,646	10425,303	39,728
13/11/2018 03:00	2,987	396252,619	0,927	13,812	10251,599	39,003
13/11/2018 04:00	3,361	409536,679	0,916	16,319	10637,651	41,03
13/11/2018 05:00	2,231	428959,733	0,901	20,357	11230,626	44,005
13/11/2018 06:00	2,016	428693,183	0,872	20,408	11240,374	44,004
13/11/2018 07:00	2,129	428154,451	0,904	20,392	11244,94	43,998
13/11/2018 08:00	1,786	426836,524	0,884	19,384	11226,601	44,001
13/11/2018 09:00	2,043	415411,295	0,803	17,808	10906,157	42,484
13/11/2018 10:00	2,795	427500,14	0,901	16,506	11135,255	43,871
13/11/2018 11:00	2,336	427998,993	0,885	16,072	11162,097	44
13/11/2018 12:00	1,958	428340,379	0,882	15,844	11172,69	43,997
13/11/2018 13:00	3,244	422704,406	0,885	17,301	11128,192	43,396
13/11/2018 14:00	1,649	399064,041	0,909	15,706	10457,651	40,004
13/11/2018 15:00	1,849	415543,598	0,897	18,028	10892,35	42,437
13/11/2018 16:00	1,529	424981,19	0,875	17,881	11184,403	43,998
13/11/2018 17:00	1,561	424581,933	0,848	17,556	11176,673	44
13/11/2018 18:00	1,568	424945,624	0,85	17,537	11183,404	43,993
13/11/2018 19:00	6,585	410285,11	0,867	18,284	10707,842	41,443
13/11/2018 20:00	10,355	401948,864	0,877	18,509	10430,061	40
13/11/2018 21:00	11,78	403140,495	0,87	18,378	10434,925	40,002
13/11/2018 22:00	6,493	428221,48	0,872	17,468	11250,115	44,084
13/11/2018 23:00	4,636	432555,882	0,869	17,319	11413,768	45,001
14/11/2018 00:00	21,265	397717,329	0,871	17,952	10385,844	39,722
14/11/2018 01:00	34,295	398373,081	0,887	17,265	10235,398	39,004
14/11/2018 02:00	18,512	396683,631	0,88	15,553	10248,28	38,993
14/11/2018 03:00	2,475	395096,941	0,862	14,416	10263,104	38,995
14/11/2018 04:00	2,219	394489,498	0,877	14,758	10259,465	38,998
14/11/2018 05:00	2,266	407495,622	0,866	17,045	10627,692	41,026
14/11/2018 06:00	1,957	428173,677	0,823	21,394	11237,377	44
14/11/2018 07:00	1,828	427106,654	0,851	19,65	11242,451	43,999
14/11/2018 08:00		425430,108	0,849	17,803	11232,246	43,997
14/11/2018 09:00	1,947	427425,296	6,505	15,982	11185,228	44,001
14/11/2018 10:00	1,608	425536,91	0,826	14,739	11159,578	44,001
14/11/2018 11:00	1,605	423966,64	0,836	15,468	11139,227	44,001
14/11/2018 12:00	1,519	421492,49	0,833	15,208	11145,911	44
14/11/2018 13:00	1,488	420941,504	0,845	15,125	11128,774	44,003
14/11/2018 14:00	1,491	419531,777	0,835	15,282	11094,156	43,929
14/11/2018 15:00	1,48	419675,736	0,845	15,462	11089,948	43,904
14/11/2018 16:00	1,495	419415,021	0,819	15,491	11056,353	43,71
14/11/2018 17:00	1,496	419671,515	0,79	15,445	11075,387	43,791
14/11/2018 18:00	1,483	423678,081	0,787	15,033	11153,611	43,996
14/11/2018 19:00	1,491	423346,824	0,787	15,115	11174,758	43,999
14/11/2018 20:00	1,518	423337,12	0,773	15,254	11194,281	43,999
14/11/2018 21:00	1,552	424140,203	0,79	14,61	11209,247	43,995
14/11/2018 22:00	1,592	426146,549	0,806	14,034	11210,558	44,005
14/11/2018 23:00	1,678	427136,458	0,814	14,747	11203,863	44,001
15/11/2018 00:00	1,796	426702,316	0,818	15,385	11199,616	44,002
15/11/2018 01:00	2,266	427898,069	0,834	15,829	11197,528	43,999
15/11/2018 02:00	2,68	428319,64	0,838	16,291	11200,233	43,998
15/11/2018 03:00	4,466	428911,276	0,829	16,268	11198,826	44
15/11/2018 04:00	4,385	428357,014	0,835	16,403	11198,971	44,003
15/11/2018 05:00	4,215	428244,427	0,835	16,492	11183,552	44,003
15/11/2018 06:00	4,495	427645,437	0,796	16,277	11197,585	44,001
15/11/2018 07:00	1,93	427006,533	0,818	15,301	11199,098	44,007
15/11/2018 08:00	1,593	425398,527	0,796	14,262	11179,733	44,002
15/11/2018 09:00	1,563	422009,397	5,885	14,932	11165,013	44,002
15/11/2018 10:00	1,527	422004,286	0,793	14,991	11154,403	44,002
15/11/2018 11:00	1,536	421757,427	0,785	14,759	11143,383	44,004
15/11/2018 12:00	1,535	415452,281	0,789	14,719	11020,615	43,308
15/11/2018 13:00	1,507	411546,833	0,803	14,805	10939,752	42,998
15/11/2018 14:00	1,517	411935,638	0,798	14,788	10917,454	42,997

15/11/2018 15:00	1,514	412586,48	0,811	14,931	10898,632	42,98
15/11/2018 16:00	1,606	406000,916	0,838	15,443	10689,543	41,866
15/11/2018 17:00	1,927	368385,934	0,836	19,745	9615,351	36,005
15/11/2018 18:00	2,205	370024,054	0,828	18,728	9627,44	35,999
15/11/2018 19:00	4,75	370695,1	0,831	17,2	9641,949	36,003
15/11/2018 20:00	5,64	394232,259	0,829	15,895	10334,668	39,489
15/11/2018 21:00	1,518	423704,799	0,796	14,696	11200,399	44,004
15/11/2018 22:00	1,518	424550,043	0,801	14,204	11201,446	44
15/11/2018 23:00	2,296	415326,829	0,809	14,815	10945,11	42,595
16/11/2018 00:00	4,716	393303,389	0,815	17,757	10220,057	39,003
16/11/2018 01:00	6,71	394310,123	0,833	17,551	10216,865	39,003
16/11/2018 02:00	7,621	394263,983	0,862	17,381	10216,817	38,999
16/11/2018 03:00	4,314	417462,367	0,849	16,03	10901,338	42,396
16/11/2018 04:00	2,326	428017,994	0,827	15,608	11186,949	43,999
16/11/2018 05:00	2,467	427837,39	0,808	15,551	11178,767	43,999
16/11/2018 06:00	1,866	428050,977	0,795	15,223	11400,759	44,979
16/11/2018 07:00	1,601	429721,958	0,811	15,218	11813,496	46,996
16/11/2018 08:00	1,546	430796,49	0,798	15,397	11736,932	46,685
16/11/2018 09:00	1,56	430816,736	0,69	15,319	11546,486	45,879
16/11/2018 10:00	1,569	428693,44	0,772	15,127	11393,627	45,171
16/11/2018 11:00	1,509	424190,344	0,771	14,851	11264,811	44,519
16/11/2018 12:00	1,485	420136,409	0,79	14,486	11144,033	43,999
16/11/2018 13:00	1,472	419826,561	0,789	14,595	11145,337	44,001
16/11/2018 14:00	1,467	421698,905	0,799	14,576	11142,577	43,999
16/11/2018 15:00	1,467	421541,622	0,787	14,617	11140,935	44,002
16/11/2018 16:00	1,478	423159,389	0,795	14,834	11137,171	44
16/11/2018 17:00	1,487	424668,602	0,84	15,098	11139,7	44
16/11/2018 18:00	1,497	424634,626	0,843	15,455	11180,514	44
16/11/2018 19:00	1,48	425274,753	0,839	14,679	11192,193	44
16/11/2018 20:00	1,554	426766,099	0,834	14,355	11193,775	43,998
16/11/2018 21:00	1,616	427348,746	0,838	14,539	11193,389	44
16/11/2018 22:00	1,704	427390,126	0,842	14,714	11205,063	44,001
16/11/2018 23:00	2,277	427952,79	0,839	15,434	11202,81	44,001
17/11/2018 00:00	3,886	426021,632	0,833	16,1	11187,492	43,999
17/11/2018 01:00	36,634	366636,716	0,893	12,574	9340,912	34,342
17/11/2018 02:00	50,258	362220,487	0,909	11,844	9142,83	33,5
17/11/2018 03:00	48,335	363979,688	0,931	11,71	9181,641	33,711
17/11/2018 04:00	36,244	367048,871	0,956	11,526	9311,49	34,303
17/11/2018 05:00	40,012	367332,292	0,944	11,542	9311,414	34,304
17/11/2018 06:00	36,822	366989,784	0,907	11,547	9307,175	34,302
17/11/2018 07:00	31,982	366690,221	0,922	11,656	9285,396	34,298
17/11/2018 08:00	18,872	370193,633	0,903	12,111	9436,774	35,134
17/11/2018 09:00		380636,386	1,235	13,973	9807,734	36,998
17/11/2018 10:00		381698,837	0,87	13,973	9885,181	37,445
17/11/2018 11:00		429540,48	0,839	17,069	11568,266	46,001
17/11/2018 12:00		430414,308	0,721	17,069	11551,939	45,991
17/11/2018 13:00	1,412	430607,107	0,83	15,883	11581,98	45,998
17/11/2018 14:00	1,406	430607,25	0,836	15,935	11573,78	46
17/11/2018 15:00	2,377	423633,49	0,837	16,033	11336,617	44,713
17/11/2018 16:00	28,62	344345,621	0,779	13,406	8604,59	30,999
17/11/2018 17:00	18,504	363526,005	0,842	14,195	9210,128	34,172
17/11/2018 18:00	1,492	417340,221	0,788	15,832	10960,892	43,004
17/11/2018 19:00	1,512	418207,403	0,788	15,571	10995,18	42,996
17/11/2018 20:00	1,688	419662,341	0,784	15,514	11023,8	42,997
17/11/2018 21:00	2,299	420249,012	0,786	16,015	11050,091	43
17/11/2018 22:00	3,662	421271,717	0,801	16,889	11052,199	42,999
17/11/2018 23:00	29,546	373451,95	0,855	14,187	9560,259	35,456
18/11/2018 00:00	38,226	356835,08	0,874	13,113	9089,709	32,998
18/11/2018 01:00	38,628	357534,922	0,882	13,108	9087,286	33
18/11/2018 02:00	45,522	358988,917	0,885	13,006	9091,751	32,997
18/11/2018 03:00	53,204	359085,019	0,885	12,849	9091,672	33,001
18/11/2018 04:00	60,652	359541,534	0,882	12,636	9098,914	33
18/11/2018 05:00	39,692	363833,269	0,872	12,321	9276,01	33,972
18/11/2018 06:00	33,588	364908,788	0,844	12,436	9300,514	34,001
18/11/2018 07:00	18,376	363211,939	0,86	12,488	9293,657	33,999
18/11/2018 08:00	7,569	361207,468	0,848	13,267	9283,54	33,999
18/11/2018 09:00		359605,003	1,52	12,533	9271,229	34
18/11/2018 10:00	2,093	358041,499	0,826	14,375	9275,41	34
18/11/2018 11:00	1,871	355809,455	0,84	15,481	9275,08	33,997
18/11/2018 12:00	7,841	351437,786	0,855	18,291	9083,632	33,206
18/11/2018 13:00	5,639	330342,482	0,873	15,338	8446,358	29,998
18/11/2018 14:00	3,943	330239,823	0,874	15,848	8440,007	30,002
18/11/2018 15:00	2,883	330597,611	0,874	16,417	8426,705	29,997
18/11/2018 16:00	3,019	336463,965	0,873	16,418	8583,942	30,917
18/11/2018 17:00	1,547	406223,234	0,767	16,17	10763,237	41,962
18/11/2018 18:00	1,538	410391,202	0,764	16,038	10884,262	42,468
18/11/2018 19:00	1,634	415813,249	0,772	16,132	11035,249	42,991
18/11/2018 20:00	1,692	416274,241	0,774	16,292	11073,777	43,001
18/11/2018 21:00	1,536	416201,44	0,782	16,392	11085,818	43,003
18/11/2018 22:00	9,865	402028,785	0,801	17,171	10602,943	40,545
18/11/2018 23:00	14,657	359814,6	0,839	15,952	9303,971	34,001
19/11/2018 00:00	2,28	359046,965	0,83	14,74	9311,687	34,001
19/11/2018 01:00	3,094	359245,448	0,838	14,57	9314,406	33,997
19/11/2018 02:00	4,273	360143,04	0,837	14,333	9306,197	33,999
19/11/2018 03:00	33,937	354829,734	0,86	14,182	9012,741	32,586
19/11/2018 04:00	37,637	351520,758	0,873	14,176	8902,549	32
19/11/2018 05:00	7,246	421418,843	0,797	16,269	11333,055	44,339
19/11/2018 06:00	1,551	430761,061	0,753	16,534	11698,435	46,001
19/11/2018 07:00	1,513	430527,783	0,786	16,473	11668,399	46
19/11/2018 08:00	1,502	429321,509	0,774	16,573	11595,863	45,803
19/11/2018 09:00		425956,562	0,976	17,68	11368,866	44,89
19/11/2018 10:00	1,618	421162,001	0,766	16,234	11194,676	44,107
19/11/2018 11:00	1,621	413509,473	0,759	16,011	11003,388	43,155
19/11/2018 12:00	1,524	408515,667	0,769	15,811	10915,875	42,623
19/11/2018 13:00	1,575	398725,378	0,776	16,058	10696,13	41,35
19/11/2018 14:00	1,646	388733,99	0,794	16,745	10321,902	39,801
19/11/2018 15:00	1,56	401385,491	0,779	15,897	10696,677	41,64
19/11/2018 16:00	1,556	402000,101	0,786	15,756	10688,649	41,608
19/11/2018 17:00	1,551	405743,317	0,769	15,59	10773,578	42,031
19/11/2018 18:00	1,544	410671,339	0,762	15,795	10909,006	42,64
19/11/2018 19:00	1,553	417497,053	0,757	16,056	11108,43	43,478
19/11/2018 20:00	1,563	423236,936	0,761	16,189	11268,237	44,238

19/11/2018 21:00	1,595	427778,653	0,765	16,512	11395,601	44,904
19/11/2018 22:00	1,563	430666,825	0,77	16,578	11616,906	45,795
19/11/2018 23:00	1,561	430796,543	0,775	16,285	11669,121	45,999
20/11/2018 00:00	12,863	358759,637	0,811	14,49	9833,456	36,591
20/11/2018 01:00	26,656	351268,799	0,866	13,635	8890,197	32
20/11/2018 02:00	28,625	350804,625	0,862	13,621	8885,395	32,003
20/11/2018 03:00	39,201	351737,415	0,863	13,721	8868,155	31,998
20/11/2018 04:00	47,08	352633,96	0,862	13,767	8864,656	32,002
20/11/2018 05:00	7,828	418979,437	0,808	15,968	11209,214	44,016
20/11/2018 06:00	1,572	429344,445	0,763	16,351	11653,15	45,997
20/11/2018 07:00	1,519	429416,15	0,772	16,208	11653,504	45,98
20/11/2018 08:00	1,538	429294,603	0,77	16,523	11520,741	45,416
20/11/2018 09:00		424480,254	0,93	17,686	11328,029	44,72
20/11/2018 10:00	1,584	419212,451	0,762	15,977	11145,456	43,895
20/11/2018 11:00	1,553	414935,962	0,763	15,919	11051,207	43,382
20/11/2018 12:00	1,585	409235,717	0,762	15,72	10946,51	42,857
20/11/2018 13:00	1,547	404756,279	0,776	15,632	10834,69	42,404
20/11/2018 14:00	1,549	403938,177	0,775	15,612	10774,039	42,158
20/11/2018 15:00	1,556	402359,661	0,771	15,599	10695,531	41,85
20/11/2018 16:00	1,55	403889,792	0,775	15,512	10708,646	41,943
20/11/2018 17:00	1,542	407231,192	0,792	15,597	10795,274	42,34
20/11/2018 18:00	1,527	413296,186	0,782	15,954	10939,947	43,047
20/11/2018 19:00	1,509	422960,268	0,773	16,3	11211,887	44,198
20/11/2018 20:00	1,485	428027,363	0,774	16,635	11408,593	45,109
20/11/2018 21:00	1,481	430345,399	0,776	17,014	11569,578	45,778
20/11/2018 22:00	1,532	430667,338	0,784	16,594	11625,138	45,979
20/11/2018 23:00	3,547	376070,513	0,828	14,883	9799,95	36,641
21/11/2018 00:00	3,704	358418,663	0,849	14,247	9267,075	34,001
21/11/2018 01:00	4,858	359185,487	0,869	13,905	9267,721	34
21/11/2018 02:00	8,362	360296,103	0,873	13,225	9263,472	34,002
21/11/2018 03:00	7,172	360415,875	0,869	13,412	9267,712	34,005
21/11/2018 04:00	11,329	361227,572	0,859	12,941	9263,966	33,999
21/11/2018 05:00	15,588	361497,92	0,873	12,544	9260,63	34
21/11/2018 06:00	13,13	361803,936	0,842	12,869	9272,315	34,001
21/11/2018 07:00	5,527	359946,411	0,856	13,798	9277,891	34,003
21/11/2018 08:00	2,233	372153,565	0,838	16,238	9733,019	36,35
21/11/2018 09:00		369347,104	0,997	13,939	9735,129	36,354
21/11/2018 10:00	1,899	363215,723	0,817	16,853	9543,525	35,437
21/11/2018 11:00	1,878	359996,861	0,813	16,638	9450,396	35,057
21/11/2018 12:00	1,859	356832,942	0,816	16,621	9397,807	34,768
21/11/2018 13:00	1,859	353394,866	0,827	16,59	9324,576	34,462
21/11/2018 14:00	1,861	351452,51	0,835	16,753	9234,514	34,054
21/11/2018 15:00	1,846	350984,911	0,834	16,482	9195,807	33,862
21/11/2018 16:00	1,823	356659,192	0,828	16,349	9317,953	34,485
21/11/2018 17:00	1,8	360533,677	0,848	16,323	9443,597	35,116
21/11/2018 18:00	1,767	367284,886	0,84	16,238	9593,942	35,783
21/11/2018 19:00	9,129	364489,329	0,843	15,011	9467,929	34,991
21/11/2018 20:00	41,792	350452,917	0,874	13,372	8834,655	31,854
21/11/2018 21:00	44,041	353759,684	0,876	13,181	8920,048	32,226
21/11/2018 22:00	30,688	357061,759	0,878	12,619	9087,881	32,996
21/11/2018 23:00	41,701	358033,646	0,883	12,491	9087,303	32,997
22/11/2018 00:00	44,37	357898,975	0,867	12,393	9086,828	33,001
22/11/2018 01:00	46,163	358452,443	0,898	12,378	9089,668	33,001
22/11/2018 02:00	55,178	358753,194	0,897	12,368	9090,093	32,999
22/11/2018 03:00	57,511	359081,259	0,913	12,4	9084,796	33,004
22/11/2018 04:00	58,842	359224,69	0,906	12,426	9085,747	33,002
22/11/2018 05:00	22,136	367582,513	0,889	12,344	9390,596	34,69
22/11/2018 06:00	19,543	369921,008	0,853	12,165	9475,945	34,996
22/11/2018 07:00	6,583	365907,608	0,883	12,909	9480,317	34,997
22/11/2018 08:00	4,275	365742,999	0,87	13,029	9457,323	35,002
22/11/2018 09:00		362324,489	1,148	12,866	9440,705	34,998
22/11/2018 10:00	1,887	361555,707	0,854	14,403	9452,159	34,999
22/11/2018 11:00	1,834	359875,706	0,853	15,134	9451,211	34,999
22/11/2018 12:00	6,113	361400,771	0,869	17,597	9420,254	34,999
22/11/2018 13:00	5,036	360834,09	0,871	18,286	9406,431	34,998
22/11/2018 14:00	3,476	360616,389	0,874	18,772	9397,496	35,001
22/11/2018 15:00	2,879	360389,205	0,871	19,22	9387,907	35,005
22/11/2018 16:00	2,54	360308,999	0,863	19,431	9384,382	34,996
22/11/2018 17:00	3,625	361117,822	0,841	18,376	9394,409	34,995
22/11/2018 18:00	8,041	364384,198	0,821	17,238	9409,816	35,002
22/11/2018 19:00	18,853	366780,96	0,821	16,937	9440,449	34,998
22/11/2018 20:00	27,62	367047,294	0,824	16,851	9453,541	35
22/11/2018 21:00	35,059	367860,435	0,831	16,612	9459,469	35,004
22/11/2018 22:00	37,297	367978,149	0,84	16,655	9464,842	34,998
22/11/2018 23:00	15,502	365930,258	0,838	14,28	9486,954	35,001
23/11/2018 00:00	3,179	365895,581	0,828	13,045	9485,224	34,999
23/11/2018 01:00	3,529	366711,918	0,841	12,989	9485,59	34,997
23/11/2018 02:00	5,035	366928,555	0,839	12,827	9479,034	35,003
23/11/2018 03:00	5,129	367055,839	0,826	12,795	9481,084	34,999
23/11/2018 04:00	3,96	367083,912	0,838	12,988	9476,626	34,997
23/11/2018 05:00	5,655	367899,823	0,845	12,817	9466,247	35
23/11/2018 06:00	5,393	366936,416	0,81	12,839	9478,594	34,999
23/11/2018 07:00	4,339	367152,523	0,827	12,944	9477,101	35,002
23/11/2018 08:00	2,413	365903,943	0,841	13,134	9493,007	35,001
23/11/2018 09:00		363309,639	1	13,04	9496,493	34,998
23/11/2018 10:00	1,878	361599,687	0,809	14,854	9439,999	34,998
23/11/2018 11:00	1,829	361062,743	0,818	15,372	9438,917	35
23/11/2018 12:00	5,327	362001,02	0,812	17,007	9414,243	35,001
23/11/2018 13:00	4,153	360955,859	0,827	18,114	9398,394	34,995
23/11/2018 14:00	2,644	361152,972	0,83	19,186	9393,758	35,002
23/11/2018 15:00	2,215	361470,911	0,826	19,911	9388,377	35,004
23/11/2018 16:00	2,273	362405,642	0,831	19,802	9389,552	35,002
23/11/2018 17:00	2,545	362614,708	0,836	19,575	9390,949	35,002
23/11/2018 18:00	3,802	364560,461	0,859	19,203	9401,462	35,001
23/11/2018 19:00	6,946	366388,172	0,86	18,839	9435,796	35,002
23/11/2018 20:00	10,711	366618,356	0,866	18,778	9450,554	34,998
23/11/2018 21:00	14,609	367129,627	0,88	18,747	9430,781	35,003
23/11/2018 22:00	22,826	368304,42	0,889	18,513	9464,211	34,998
23/11/2018 23:00	28,895	369077,647	0,897	18,1	9462,432	34,999
24/11/2018 00:00	24,521	368344,005	0,884	16,246	9467,327	35,002
24/11/2018 01:00	2,308	366468,445	0,898	14,047	9488,772	35,005
24/11/2018 02:00	2,733	367606,389	0,91	13,931	9485,846	35,002

24/11/2018 03:00	2,95	367780,908	0,896	13,984	9485,503	35,005
24/11/2018 04:00	3,157	367895,62	0,9	13,88	9488,64	35,002
24/11/2018 05:00	3,417	367832,795	0,909	13,766	9491,055	34,997
24/11/2018 06:00	3,218	367298,479	0,879	13,775	9488,959	34,999
24/11/2018 07:00	2,262	374771,689	0,9	15,469	9732,108	36,356
24/11/2018 08:00	1,799	396663,999	0,866	19,534	10450,783	40,006
24/11/2018 09:00		394839,575	1,124	14,003	10436,975	39,998
24/11/2018 10:00	2,018	395912,735	0,837	17,257	10373,336	40
24/11/2018 11:00	1,752	394935,757	0,83	16,397	10371,159	40
24/11/2018 12:00	1,667	392715,629	0,839	16,312	10368,841	40,003
24/11/2018 13:00	1,639	391307,587	0,845	16,465	10361,715	40
24/11/2018 14:00	1,647	391625,381	0,849	16,841	10340,972	39,995
24/11/2018 15:00	1,652	391541,682	0,843	17,001	10323,611	40,001
24/11/2018 16:00	1,647	392303,672	0,849	16,763	10325,569	40
24/11/2018 17:00	1,651	392720,554	1,42	17,135	10331,357	39,999
24/11/2018 18:00	1,654	394804,073	0,83	17,231	10346,779	39,999
24/11/2018 19:00	1,716	396229,467	0,829	18,154	10373,573	39,999
24/11/2018 20:00	1,947	397399,838	0,84	19,13	10405,156	39,997
24/11/2018 21:00	2,314	398682,995	0,844	18,726	10407,146	40,006
24/11/2018 22:00	3,465	391863,569	0,852	18,831	10207,501	38,902
24/11/2018 23:00	4,233	375231,564	0,874	19,125	9723,47	36,414
25/11/2018 00:00	33,76	344263,341	0,894	14,595	8686,752	31,067
25/11/2018 01:00	42,602	344397,691	0,923	14,741	8665,262	31,004
25/11/2018 02:00	47,056	345579,579	0,894	14,871	8668,488	31,004
25/11/2018 03:00	43,524	347200,995	0,905	14,682	8712,014	31,272
25/11/2018 04:00	30,772	351327,298	0,909	14,463	8862,692	32,005
25/11/2018 05:00	33,824	351314,169	0,907	14,396	8860,947	32,007
25/11/2018 06:00	42,955	352117,596	0,868	14,259	8870,752	31,999
25/11/2018 07:00	35,423	351394,916	0,903	14,136	8863,269	32
25/11/2018 08:00	24,527	350450,243	0,902	14,281	8844,065	32,001
25/11/2018 09:00		348964,561	1,164	13,209	8838,74	31,997
25/11/2018 10:00	5,813	347277,703	0,887	14,777	8825,756	31,998
25/11/2018 11:00	2,804	345205,339	0,874	15,705	8819,562	32
25/11/2018 12:00	2,348	343069,63	0,867	16,079	8819,675	31,998
25/11/2018 13:00	2,09	342094,797	0,878	16,528	8820,122	32,004
25/11/2018 14:00	1,981	342811,89	0,877	16,893	8815,657	32,002
25/11/2018 15:00	1,94	341697,765	0,877	17,319	8804,822	32,003
25/11/2018 16:00	1,955	345498,637	0,88	17,331	8877,381	32,491
25/11/2018 17:00	2,437	382443,846	0,828	18,126	9958,069	38,001
25/11/2018 18:00	3,686	384342,17	0,832	17,549	9976,651	38
25/11/2018 19:00	3,289	383189,353	0,828	20,351	10030,909	38,003
25/11/2018 20:00	1,915	383526,488	0,817	21,732	10059,903	37,998
25/11/2018 21:00	2,449	385234,368	0,828	20,85	10065,126	38,002
25/11/2018 22:00	3,705	386219,058	0,823	20,078	10063,061	38
25/11/2018 23:00	5,02	387116,722	0,833	19,71	10060,332	38,001
26/11/2018 00:00	7,966	387740,48	0,841	19,141	10055,212	37,998
26/11/2018 01:00	8,819	387373,105	0,867	19,154	10061,158	38
26/11/2018 02:00	9,889	387883,541	0,874	18,973	10062,416	37,998
26/11/2018 03:00	12,979	388264,876	0,868	19,027	10059,095	38,006
26/11/2018 04:00	12,422	388378,471	0,879	18,923	10060,508	38,005
26/11/2018 05:00	17,258	388994,051	0,87	18,947	10049,867	37,999
26/11/2018 06:00	14,387	388701,979	0,85	18,897	10059,094	37,998
26/11/2018 07:00	8,779	383410,486	0,866	18,074	9944,232	37,301
26/11/2018 08:00	2,856	361992,413	0,87	15,206	9385,267	34,545
26/11/2018 09:00		383353,302	1,17	14,346	10037,922	38,001
26/11/2018 10:00	1,955	382308,841	0,826	21,423	10038,855	38,005
26/11/2018 11:00	1,626	414836,997	0,798	16,961	10952,555	42,859
26/11/2018 12:00	10,593	372823,817	0,828	17,085	9677,857	36,264
26/11/2018 13:00	6,858	395503,065	0,828	17,208	10395,179	40,112
26/11/2018 14:00	2,578	384907,762	0,835	18,024	10114,424	38,605
26/11/2018 15:00	2,073	394548,727	0,827	17,578	10355,333	40,14
26/11/2018 16:00	1,541	417109,463	0,799	16,073	11064,464	43,512
26/11/2018 17:00	1,53	423000,987	0,806	16,208	11207,204	44,211
26/11/2018 18:00	1,504	428433,56	0,815	16,124	11378,005	44,909
26/11/2018 19:00	1,497	428435,068	0,808	16,194	11440,268	44,997
26/11/2018 20:00	1,502	428626,913	0,802	16,603	11453,319	45,001
26/11/2018 21:00	1,515	429018,118	0,797	16,647	11460,004	44,997
26/11/2018 22:00	1,536	428926,214	0,795	16,311	11463,576	44,997
26/11/2018 23:00	1,565	429280,29	0,823	15,939	11463,193	44,998
27/11/2018 00:00	1,59	429456,108	0,826	15,605	11457,226	44,997
27/11/2018 01:00	1,793	430348,774	0,86	16,412	11449,777	44,996
27/11/2018 02:00	1,746	430561,023	0,836	16,221	11452,329	45
27/11/2018 03:00	1,542	429943,428	0,847	15,309	11455,176	45,001
27/11/2018 04:00	1,554	429762,091	0,855	15,395	11448,543	44,999
27/11/2018 05:00	1,734	428974,344	0,855	15,928	11442,317	44,998
27/11/2018 06:00	1,705	428604,271	0,818	15,713	11457,099	44,998
27/11/2018 07:00	1,569	429013,114	0,829	16,052	11454,059	45
27/11/2018 08:00	1,565	429101,897	0,839	16,359	11435,421	44,997
27/11/2018 09:00		428748,558	2,287	17,723	11414,705	44,995
27/11/2018 10:00	1,562	428426,1	0,809	15,922	11401,446	45,001
27/11/2018 11:00	1,553	425855,474	0,795	16,029	11334,197	44,658
27/11/2018 12:00	1,519	421360,569	0,807	15,939	11223,415	44,095
27/11/2018 13:00	3,398	364080,371	0,859	18,92	9495,912	35,405
27/11/2018 14:00	2,382	361096,022	0,861	20,047	9380,289	35,004
27/11/2018 15:00	1,968	378320,942	0,854	18,843	9896,788	37,727
27/11/2018 16:00	1,57	407436,9	0,83	15,834	10798,916	42,256
27/11/2018 17:00	1,576	409230,033	0,835	15,788	10832,033	42,44
27/11/2018 18:00	1,553	416621,431	0,754	16,066	11010,586	43,267
27/11/2018 19:00	1,529	425628,156	0,743	16,286	11289,843	44,502
27/11/2018 20:00	1,522	428331,39	0,742	16,08	11418,254	44,998
27/11/2018 21:00	1,528	428099,598	0,753	16,171	11420,641	44,998
27/11/2018 22:00	1,53	428559,459	0,747	16,168	11426,032	45,002
27/11/2018 23:00	1,592	429546,758	0,746	16,17	11437,518	45,004
28/11/2018 00:00	1,649	429638,189	0,747	16,132	11428,321	45
28/11/2018 01:00	1,594	429682,723	0,775	15,988	11423,048	44,998
28/11/2018 02:00	1,671	429540,513	0,777	15,689	11430,387	44,999
28/11/2018 03:00	1,604	429607,269	0,774	15,569	11431,714	45,001
28/11/2018 04:00	1,682	429795,608	0,769	15,237	11431,257	45,002
28/11/2018 05:00	1,705	430064,073	0,765	15,019	11433,014	45,002
28/11/2018 06:00	1,625	429678,183	0,753	15,125	11428,981	44,999
28/11/2018 07:00	1,598	428861,648	0,776	15,525	11415,311	45
28/11/2018 08:00	1,629	428959,239	0,767	15,992	11423,443	44,997

28/11/2018 09:00		427928,167	1,007	17,694	11423,773	44,999
28/11/2018 10:00	1,559	428378,316	0,736	15,835	11377,27	44,996
28/11/2018 11:00	1,541	428009,31	0,729	15,888	11360,843	44,996
28/11/2018 12:00	1,527	425482,433	0,742	16,136	11311,656	44,762
28/11/2018 13:00	1,543	423665,231	0,737	16,481	11047,448	44,555
28/11/2018 14:00	1,567	419582,78	0,751	16,637	10747,021	44,003
28/11/2018 15:00	1,555	420313,756	0,745	16,497	10784,356	44,007
28/11/2018 16:00	1,547	423025,193	0,752	16,537	10891,667	44,225
28/11/2018 17:00	1,526	427650,476	0,738	16,593	11023,831	44,841
28/11/2018 18:00	1,531	429143,727	0,823	16,577	10951,224	44,997
28/11/2018 19:00	1,529	429564,52	0,817	16,629	11039,514	44,999
28/11/2018 20:00	1,533	429380,522	0,821	16,461	11075,638	45
28/11/2018 21:00	1,523	429883,71	0,83	15,982	11241,367	44,996
28/11/2018 22:00	1,541	429851,482	0,83	15,78	11224,653	45
28/11/2018 23:00	1,552	429906,873	0,836	15,255	11245,017	44,998
29/11/2018 00:00	1,607	429915,639	0,827	15,51	11283,286	45,002
29/11/2018 01:00	1,686	429635,664	0,841	15,891	11303,96	44,996
29/11/2018 02:00	1,912	429469,336	0,845	16,347	11383,158	44,999
29/11/2018 03:00	1,861	429974,352	0,838	16,058	11397,165	45
29/11/2018 04:00	2,035	430210,042	0,849	16,535	11394,156	44,999
29/11/2018 05:00	2,446	430201,286	0,846	16,948	11414,306	45,002
29/11/2018 06:00	4,134	429659,229	0,821	17,412	11404,629	44,998
29/11/2018 07:00	2,126	429252,096	0,844	15,867	11372,249	45
29/11/2018 08:00	1,572	429228,351	0,849	15,063	11230,71	45,001
29/11/2018 09:00		428541,709	1,027	17,025	11220,085	45,001
29/11/2018 10:00		428407,306	1,213	17,662	11211,697	44,998
29/11/2018 11:00	51,045	428313,031	0,792	15,958	11228,724	45,005
29/11/2018 12:00	1,548	427563,479	0,819	15,927	11241,048	44,996
29/11/2018 13:00	1,536	426803,378	0,835	15,926	11240,75	44,987
29/11/2018 14:00	1,528	425284,291	0,842	16,374	11094,804	44,787
29/11/2018 15:00	23,314	362038,754	0,896	15,38	9084,35	34,36
29/11/2018 16:00	13,751	387652,636	0,885	15,795	9781,099	38,435
29/11/2018 17:00	1,532	426788,119	0,84	16,323	11106,199	44,934
29/11/2018 18:00	1,52	427883,718	0,829	16,127	11142,701	45
29/11/2018 19:00	1,519	428226,423	0,822	16,13	11214,616	45,002
29/11/2018 20:00	1,524	428603,011	0,829	16,139	11247,934	44,996
29/11/2018 21:00	1,496	429037,772	0,834	15,329	11292,957	44,997
29/11/2018 22:00	1,505	429296,71	0,834	14,762	11295,412	45,002
29/11/2018 23:00	1,539	429747,454	0,839	14,597	11308,69	45,003
30/11/2018 00:00	1,528	430349,135	0,83	14,679	11318,601	45,001
30/11/2018 01:00	1,658	430845,526	0,84	15,101	11325,311	45
30/11/2018 02:00	1,7	431691,841	0,849	15,492	11333,676	44,999
30/11/2018 03:00	1,694	432161,613	0,846	15,558	11336,463	44,995
30/11/2018 04:00	1,895	431366,816	0,846	16,131	11335,627	44,999
30/11/2018 05:00	1,926	430862,137	0,855	16,458	11301,058	45,001
30/11/2018 06:00	1,681	430772,269	0,829	16,059	11206,012	44,997
30/11/2018 07:00	1,567	430183,575	0,847	15,12	11196,035	45,001
30/11/2018 08:00	1,581	429203,951	0,84	15,913	11191,429	44,999
30/11/2018 09:00		429090,58	1,673	17,642	11170,948	44,998
30/11/2018 10:00		428622,533	0,82	17,642	11187,728	44,999
30/11/2018 11:00		416314,584	0,766	17,642	11171,334	44,998
30/11/2018 12:00	1,487	424481,52	0,845	17,067	11117,452	44,759
30/11/2018 13:00	1,485	424955,443	0,839	17,099	11155,317	44,887
30/11/2018 14:00	1,49	424062,112	0,835	17,067	11127,902	44,681
30/11/2018 15:00	1,491	421553,382	0,836	16,924	11067,253	44,315
30/11/2018 16:00	1,502	421969,803	0,839	16,857	11056,55	44,28
30/11/2018 17:00	1,498	424825,927	0,839	17,005	11149,461	44,649
30/11/2018 18:00	1,483	427596,804	0,804	16,982	11224,941	44,98
30/11/2018 19:00	1,493	427811,757	0,793	16,771	11244,365	45
30/11/2018 20:00	1,488	433311,466	0,788	17,193	11415,064	45,966
30/11/2018 21:00	1,497	436142,399	0,8	17,283	11504,458	46,412
30/11/2018 22:00	1,532	439282,058	0,807	17,239	11597,766	46,86
30/11/2018 23:00	1,545	431334,991	0,817	16,303	11470,202	45,403
01/12/2018 00:00	1,471	430300,679	0,816	15,818	11422,412	44,998
01/12/2018 01:00	1,52	430715,433	0,838	15,698	11398,011	44,999
01/12/2018 02:00	1,584	432122,48	0,846	15,294	11386,435	45,002
01/12/2018 03:00	1,479	431447,221	0,848	15,404	11388,62	45,002
01/12/2018 04:00	1,467	430768,611	0,84	15,468	11390,044	45,001
01/12/2018 05:00	1,507	432415,153	0,838	15,205	11417,887	45,002
01/12/2018 06:00	1,518	431068,495	0,813	15,34	11371,884	45,001
01/12/2018 07:00	1,531	430510,962	0,855	15,406	11477,733	45,006
01/12/2018 08:00	1,551	429783,582	0,831	16,024	11459,448	45,001
01/12/2018 09:00		427893,335	0,734	16,982	11243,182	45,001
01/12/2018 10:00	1,529	427097,272	0,81	16,662	11194,857	44,942
01/12/2018 11:00	1,539	422939,257	0,81	16,776	11109,082	44,553
01/12/2018 12:00	1,507	417625,827	0,811	16,681	10979,837	43,891
01/12/2018 13:00	1,527	415649,983	0,812	16,666	10914,926	43,643
01/12/2018 14:00	1,521	414232,163	0,818	16,59	10840,22	43,343
01/12/2018 15:00	1,527	413513,558	0,815	16,656	10820,749	43,234
01/12/2018 16:00	1,51	416262,189	0,81	16,787	10853,78	43,501
01/12/2018 17:00	1,496	423632,085	0,799	17,107	11038,021	44,415
01/12/2018 18:00	1,468	427497,543	0,801	16,873	11178,195	44,875
01/12/2018 19:00	10,532	361009,944	0,864	16,163	9024,63	33,55
01/12/2018 20:00	3,854	360060,715	0,862	14,386	9027,657	33,762
01/12/2018 21:00	1,948	379042,487	0,851	18,124	9670,58	36,924
01/12/2018 22:00	1,662	410623,99	0,832	20,045	10578,847	41,924
01/12/2018 23:00	1,504	430887,837	0,819	16,546	11160,766	44,994
02/12/2018 00:00	1,483	430341,847	0,809	16,522	11205,585	45,002
02/12/2018 01:00	1,498	430906,758	0,816	16,638	11300,564	45,002
02/12/2018 02:00	1,559	430804,936	0,826	16,405	11304,914	45,001
02/12/2018 03:00	1,576	431401,756	0,819	15,735	11304,098	44,998
02/12/2018 04:00	1,592	432016,105	0,825	15,619	11319,328	45,003
02/12/2018 05:00	1,614	432256,266	0,826	15,391	11353,095	45,001
02/12/2018 06:00	1,531	431944,255	0,786	15,669	11381,585	45,002
02/12/2018 07:00	1,555	430538,588	0,824	16,261	11285,396	44,998
02/12/2018 08:00	1,569	429332,607	0,82	16,797	11193,336	44,997
02/12/2018 09:00		428809,964	1,253	16,978	11178,435	45,004
02/12/2018 10:00	1,511	428565,218	0,818	16,778	11169,422	45
02/12/2018 11:00	1,552	426946,574	0,808	16,751	11142,405	44,992
02/12/2018 12:00	1,499	424655,79	0,804	16,987	11105,166	44,855
02/12/2018 13:00	1,5	421144,505	0,805	16,972	10997,908	44,354
02/12/2018 14:00	1,511	418946,316	0,804	16,871	10916,06	43,982

02/12/2018 15:00	1,517	417505,542	0,81	16,836	10874,124	43,809
02/12/2018 16:00	1,496	420839,859	0,811	16,929	10954,982	44,169
02/12/2018 17:00	1,471	426561,74	0,81	16,855	11111,797	44,876
02/12/2018 18:00	1,466	428420,948	0,793	16,682	11161,991	45,001
02/12/2018 19:00	1,476	428579,066	0,8	16,687	11196,348	45
02/12/2018 20:00	1,51	428839,469	0,806	16,775	11219,947	45
02/12/2018 21:00	1,515	430044,479	0,81	16,455	11287,493	44,999
02/12/2018 22:00	1,528	430642,254	0,817	15,959	11292,079	45
02/12/2018 23:00	1,548	430992,141	0,822	15,589	11290,105	44,997
03/12/2018 00:00	1,508	431194,148	0,813	15,232	11266,309	45
03/12/2018 01:00	1,545	432386,759	0,822	15,091	11287,063	45,003
03/12/2018 02:00	1,647	432698,338	0,838	15,208	11288,364	45
03/12/2018 03:00	1,645	433022,535	0,835	15,427	11316,664	44,999
03/12/2018 04:00	1,727	433530,184	0,838	15,403	11431,511	45,004
03/12/2018 05:00	1,807	433085,601	0,83	15,574	11453,047	44,999
03/12/2018 06:00	1,837	433001,221	0,794	15,542	11395,929	45,001
03/12/2018 07:00	1,585	432292,706	0,82	15,576	11264,881	44,999
03/12/2018 08:00	1,476	431197,588	0,816	15,325	11224,636	44,996
03/12/2018 09:00		430844,28	0,978	16,968	11216,782	45,001
03/12/2018 10:00	1,514	428438,87	0,795	16,457	11183,637	44,999
03/12/2018 11:00	1,558	428675,046	0,803	16,414	11172,116	44,998
03/12/2018 12:00	16,88	396530,174	0,83	15,97	10187,218	39,77
03/12/2018 13:00	19,492	338251,637	0,893	14,327	8270,746	30
03/12/2018 14:00	14,208	338221,622	0,901	14,789	8262,641	29,998
03/12/2018 15:00	7,195	387755,75	0,858	16,202	9857,784	38,425
03/12/2018 16:00	1,482	428199,865	0,825	16,786	11150,388	45,001
03/12/2018 17:00	1,487	428678,161	0,817	16,812	11168,221	44,997
03/12/2018 18:00	1,49	429347,669	0,808	16,718	11206,364	45
03/12/2018 19:00	1,475	429720,986	0,83	16,204	11270,658	44,998
03/12/2018 20:00	1,449	431422,719	0,834	15,353	11264,556	44,998
03/12/2018 21:00	1,472	432504,182	0,835	15,238	11268,345	45,002
03/12/2018 22:00	1,512	433452,468	0,833	16,427	11101,771	44,998
03/12/2018 23:00	1,6	434268,597	0,826	17,427	11085,249	44,993
04/12/2018 00:00	1,744	435345,753	0,824	18,245	11094,036	44,999
04/12/2018 01:00	1,801	435709,398	0,834	18,288	11098,987	45,001
04/12/2018 02:00	1,783	435738,218	0,838	18,277	11072,61	44,997
04/12/2018 03:00	1,749	435652,952	0,835	18,209	11092,761	44,998
04/12/2018 04:00	1,782	435688,875	0,847	18,207	11094,527	44,999
04/12/2018 05:00	8,817	402698,099	0,871	16,886	10111,94	39,774
04/12/2018 06:00	16,348	392092,747	0,86	17,327	9802,604	38,163
04/12/2018 07:00	159,572	103465,871	16,275	7,483	2884,51	8,571
04/12/2018 08:00		0	0	0,266	0	0
04/12/2018 09:00		0	0	0	0	0
04/12/2018 10:00		0	0	0,057	0	0
04/12/2018 11:00		0	0	0,043	0	0
04/12/2018 12:00		0	0	0,034	0	0
04/12/2018 13:00		1399,217	0	0,016	0	0
04/12/2018 14:00		0	0	0,016	0	0
04/12/2018 15:00		0	0	0,031	0	0
04/12/2018 16:00		0	0	0,028	0	0
04/12/2018 17:00		0	0	0,023	0	0
04/12/2018 18:00		51720,012	0,272	6,105	3691,808	12,395
04/12/2018 19:00	15,449	360289,386	0,868	14,265	8937,704	33,735
04/12/2018 20:00	20,277	356133,001	0,899	13,422	8785,672	33,002
04/12/2018 21:00	14,364	378244,65	0,89	17,056	9425,143	36,439
04/12/2018 22:00	1,611	432785,292	0,845	17,032	11044,716	44,893
04/12/2018 23:00	1,591	433339,52	0,83	17,181	11101,738	45,002
05/12/2018 00:00	1,644	433489,735	0,816	17,722	11109,967	44,997
05/12/2018 01:00	1,704	433999,226	0,827	17,973	11115,808	44,997
05/12/2018 02:00	1,691	433715,405	0,826	17,91	11105,859	44,999
05/12/2018 03:00	1,647	433831,728	0,831	17,702	11097,156	44,999
05/12/2018 04:00	1,666	433457,176	0,829	17,793	11090,731	45,003
05/12/2018 05:00	1,805	433895,77	0,83	18,496	11111,239	45,001
05/12/2018 06:00	1,838	434042,6	0,807	18,618	11115,162	45,001
05/12/2018 07:00	1,796	433235,518	0,837	18,134	11115,274	44,999
05/12/2018 08:00	1,59	431408,558	0,812	16,424	11102,251	44,998
05/12/2018 09:00		430341,473	1,288	16,975	11073,919	45,001
05/12/2018 10:00	1,633	428684,86	0,809	14,671	11044,561	44,999
05/12/2018 11:00	1,59	427271,974	0,806	15,424	11033,819	44,998
05/12/2018 12:00	1,628	426429,68	0,815	15,435	11028,189	44,997
05/12/2018 13:00	1,54	424899,158	0,812	15,42	11034,554	44,997
05/12/2018 14:00	1,5	424045,282	0,813	15,576	11032,986	44,941
05/12/2018 15:00	1,505	423588,056	0,819	15,751	11036,965	44,781
05/12/2018 16:00	1,51	425988,58	0,818	15,718	11093,698	44,954
05/12/2018 17:00	1,539	426448,187	0,834	15,756	11100,268	44,996
05/12/2018 18:00	1,483	426298,595	0,807	15,744	11078,703	45,002
05/12/2018 19:00	1,5	426904,283	0,78	15,768	11094,313	45,002
05/12/2018 20:00	1,552	426537,491	0,773	15,364	11120,108	44,995
05/12/2018 21:00	1,547	427323,289	0,759	15,061	11133,35	44,999
05/12/2018 22:00	1,562	428621,109	0,762	14,629	11136,561	44,998
05/12/2018 23:00	1,532	428895,406	0,782	14,61	11134,813	44,995
06/12/2018 00:00	1,522	429551,213	0,782	15,011	11120,815	44,999
06/12/2018 01:00	1,521	430260,523	0,799	14,813	11160,942	44,996
06/12/2018 02:00	1,592	431204,059	0,789	14,634	11176,618	45,002
06/12/2018 03:00	1,56	431057,039	0,772	14,072	11169,323	44,998
06/12/2018 04:00	1,638	431877,534	0,783	14,914	11144,933	45,001
06/12/2018 05:00	1,734	431756,655	0,807	15,551	11134,018	44,999
06/12/2018 06:00	1,635	431362,789	0,757	15,141	11144,697	44,999
06/12/2018 07:00	1,647	421229,525	0,792	15,463	10918,337	43,587
06/12/2018 08:00	1,569	415827,256	0,785	14,279	10778,191	43,001
06/12/2018 09:00		413155,38	1,558	17,61	10752,226	42,999
06/12/2018 10:00	1,645	412611,909	0,776	14,884	10729,905	42,999
06/12/2018 11:00	1,619	411729,485	0,759	14,892	10723,991	42,999
06/12/2018 12:00	1,606	410380,078	0,766	14,885	10722,808	42,999
06/12/2018 13:00	1,587	408719,173	0,776	14,955	10701,333	42,927
06/12/2018 14:00	4,454	407585,948	0,814	14,468	10620,449	42,69
06/12/2018 15:00	175,482	406229,402	0,601	18,341	10582,892	42,588
06/12/2018 16:00	1,475	407480,613	0,761	15,174	10624,134	42,757
06/12/2018 17:00	1,385	410081,259	0,774	14,888	10665,371	43
06/12/2018 18:00	1,388	411238,819	0,769	15,116	10670,354	43,002
06/12/2018 19:00	1,389	412678,84	0,786	15,104	10701,896	42,999
06/12/2018 20:00	1,394	413864,197	0,786	14,695	10735,652	43,004

06/12/2018 21:00	1,389	414890,204	0,785	14,286	10731,936	43,001
06/12/2018 22:00	1,435	414716,267	0,785	14,421	10702,19	43,002
06/12/2018 23:00	1,55	415913,574	0,808	14,936	10690,614	43,003
07/12/2018 00:00	1,511	417162,895	0,803	15,761	10668,29	43
07/12/2018 01:00	1,719	417918,344	0,837	16,471	10667,264	42,997
07/12/2018 02:00	1,769	418592,273	0,825	16,557	10673,459	43,003
07/12/2018 03:00	1,826	418931,101	0,827	16,559	10680,22	42,996
07/12/2018 04:00	1,891	419207,789	0,823	16,58	10714,304	42,997
07/12/2018 05:00	2,215	420021	0,836	16,731	10699,721	42,995
07/12/2018 06:00	1,778	418674,759	0,8	16,946	10704,576	42,996
07/12/2018 07:00	1,505	416060,588	0,824	15,23	10742,895	42,996
07/12/2018 08:00	1,458	414455,686	0,815	13,994	10691,49	43
07/12/2018 09:00		413107,279	0,725	17,56	10737,904	42,998
07/12/2018 10:00	1,434	413275,186	0,777	13,697	10759,007	42,998
07/12/2018 11:00	1,43	411835,455	0,779	14,496	10794,684	43,004
07/12/2018 12:00	1,429	410839,531	0,789	14,795	10797,711	42,999
07/12/2018 13:00	3,388	375915,551	0,821	14,674	9732,141	37,421
07/12/2018 14:00	1,411	410633,068	0,801	14,903	10795,09	42,991
07/12/2018 15:00	1,403	410740,412	0,802	14,871	10745,904	43,002
07/12/2018 16:00	1,396	411565,849	0,795	14,881	10745,124	42,997
07/12/2018 17:00	1,39	412733,998	0,793	14,682	10747,856	43,003
07/12/2018 18:00	1,362	414534,448	0,797	13,725	10759,667	43,003
07/12/2018 19:00	1,354	414979,893	0,846	13,424	10807,4	43
07/12/2018 20:00	1,397	415493,075	0,859	14,213	10804,536	42,998
07/12/2018 21:00	1,502	417003,057	0,851	14,951	10814,263	43,003
07/12/2018 22:00	1,611	417658,608	0,855	15,345	10825,241	43
07/12/2018 23:00	1,906	418457,61	0,862	15,714	10834,425	42,997
08/12/2018 00:00	2,441	418720,652	0,854	15,575	10832,514	43,001
08/12/2018 01:00	1,72	415792,763	0,856	17,029	10833,146	42,999
08/12/2018 02:00	1,56	416467,447	0,862	19,613	10857,208	42,996
08/12/2018 03:00	1,569	418420,66	0,863	20,119	10870,624	43,002
08/12/2018 04:00	1,603	418464,473	0,854	20,094	10871,412	42,997
08/12/2018 05:00	1,638	419464,969	0,868	20,034	10878,582	43,001
08/12/2018 06:00	1,569	418795,6	0,827	20,092	10807,317	43,002
08/12/2018 07:00	1,594	418098,366	0,851	19,774	10854,135	43,001
08/12/2018 08:00	1,586	417899,526	0,853	19,826	10841,58	42,996
08/12/2018 09:00		416483,349	1,146	17,554	10834,812	43
08/12/2018 10:00	1,537	416244,335	0,858	18,203	10825,078	43
08/12/2018 11:00	1,535	414921,685	0,851	16,881	10809,653	42,995
08/12/2018 12:00	1,482	415157,226	0,848	14,99	10782,985	43,001
08/12/2018 13:00	1,369	414444,287	0,857	13,699	10751,234	42,995
08/12/2018 14:00	1,373	413345,059	0,853	14,227	10731,86	43,003
08/12/2018 15:00	1,4	413015,942	0,859	15,013	10717,613	42,998
08/12/2018 16:00	1,397	412930,282	0,856	15,267	10715,976	42,996
08/12/2018 17:00	1,399	413743,777	0,854	15,223	10727,451	43,002
08/12/2018 18:00	1,368	415168,986	0,846	14,373	10757,906	43,003
08/12/2018 19:00	1,395	416649,994	0,868	14,69	10784,448	42,998
08/12/2018 20:00	1,584	417624,348	0,862	16,037	10806,301	43,002
08/12/2018 21:00	2,028	418982,394	0,867	16,079	10812,337	42,998
08/12/2018 22:00	2,061	417657,118	0,875	16,917	10806,438	42,998
08/12/2018 23:00	1,523	415517,971	0,86	18,249	10801,43	43,001
09/12/2018 00:00	1,56	415725,816	0,854	18,891	10821,393	43
09/12/2018 01:00	1,563	416978,434	0,879	20,124	10825,45	42,997
09/12/2018 02:00	1,594	417354,659	0,873	20,693	10825,93	43,001
09/12/2018 03:00	1,605	418014,87	0,87	20,656	10826,725	42,999
09/12/2018 04:00	1,634	418561,524	0,875	20,637	10835,389	42,998
09/12/2018 05:00	1,646	419176,475	0,885	20,678	10837,571	43,001
09/12/2018 06:00	1,609	418953,369	0,858	20,724	10819,424	43,002
09/12/2018 07:00	1,51	416376,127	0,889	19,174	10801,531	42,999
09/12/2018 08:00	1,502	415224,506	0,882	17,26	10789,172	43,004
09/12/2018 09:00		416451,605	1,299	17,561	10747,064	42,998
09/12/2018 10:00	1,445	414859,903	0,855	14,202	10731,329	43,001
09/12/2018 11:00	1,471	412709,351	0,859	15,147	10721,669	42,999
09/12/2018 12:00	1,432	411379,903	0,873	15,267	10716,681	43
09/12/2018 13:00	1,464	397211,266	0,89	16,426	10343,896	41,045
09/12/2018 14:00	1,612	382011,291	0,902	17,884	9810,414	38,496
09/12/2018 15:00	1,677	374855,852	0,918	18,844	9587,433	37,487
09/12/2018 16:00	1,517	390229,463	0,898	17,049	10065,107	39,998
09/12/2018 17:00	1,514	390907,855	0,899	16,973	10064,59	40
09/12/2018 18:00	1,721	388386,711	0,895	16,695	9980,455	39,323
09/12/2018 19:00	51,348	326589,455	7,925	15,964	7866,897	28,032
09/12/2018 20:00	53,129	332428,124	0,846	14,851	8076,761	29,031
09/12/2018 21:00	30,308	343867,518	0,83	13,621	8455,575	30,981
09/12/2018 22:00	17,087	349321,611	0,831	13,331	8645,649	32,001
09/12/2018 23:00	23,571	350214,443	0,834	13,269	8637,516	32,003
10/12/2018 00:00	29,566	350774,077	0,827	13,183	8637,204	32,001
10/12/2018 01:00	34,67	351334,354	0,845	13,157	8636,169	31,993
10/12/2018 02:00	20,099	363275,478	0,844	13,822	9101,509	34,257
10/12/2018 03:00	9,998	369392,372	0,845	13,541	9270,461	35,28
10/12/2018 04:00	13,451	364327,087	0,859	13,081	9051,017	34,276
10/12/2018 05:00	8,973	390184,048	0,842	17,949	9820,39	38,363
10/12/2018 06:00	16,346	381766,675	0,809	16,196	9513,853	36,639
10/12/2018 07:00	1,588	406911,167	0,806	18,654	10545,304	42,002
10/12/2018 08:00	1,548	406376,772	0,803	17,324	10510,742	42
10/12/2018 09:00		406753,31	74,481	17,564	10475,556	41,997
10/12/2018 10:00	1,476	406333,7	0,774	14,675	10463,46	41,998
10/12/2018 11:00	1,455	408533,054	0,768	15,087	10553,507	42,519
10/12/2018 12:00	1,449	409547,151	0,786	14,97	10658,986	42,998
10/12/2018 13:00	1,4	408510,438	0,778	14,932	10654,486	42,999
10/12/2018 14:00	1,403	408936,904	0,781	15,09	10641,181	43
10/12/2018 15:00	1,406	409633,687	0,779	15,327	10621,755	42,986
10/12/2018 16:00	1,401	410694,249	0,782	15,251	10635,172	43
10/12/2018 17:00	1,415	411949,57	0,773	15,558	10649,554	43,002
10/12/2018 18:00	1,431	413173,04	0,774	15,878	10669,46	42,997
10/12/2018 19:00	1,42	413371,137	0,797	15,539	10695,483	42,997
10/12/2018 20:00	1,397	414650,056	0,808	15,091	10703,942	42,999
10/12/2018 21:00	1,419	415564,949	0,818	15,837	10709,591	43,001
10/12/2018 22:00	1,537	416952,056	0,817	17,225	10708,561	43,001
10/12/2018 23:00	1,656	418114,247	0,838	17,392	10706,336	42,997
11/12/2018 00:00	1,819	418705,652	0,812	17,178	10706,327	42,999
11/12/2018 01:00	1,669	416416,179	0,826	18,287	10734,097	43
11/12/2018 02:00	1,581	415516,096	0,817	19,243	10749,019	43,002

11/12/2018 03:00	1,593	416788,468	0,829	20,386	10754,649	43,002
11/12/2018 04:00	1,616	417518,634	0,826	21,511	10757,582	42,998
11/12/2018 05:00	1,582	417018,33	0,852	21,224	10763,55	43
11/12/2018 06:00	1,579	417310,356	0,799	20,457	10772,106	42,999
11/12/2018 07:00	1,621	415474,381	0,832	18,572	10773,056	43,001
11/12/2018 08:00	1,602	414335,347	0,838	17,734	10776,814	43,002
11/12/2018 09:00		413959,07	1,496	17,559	10770,933	43
11/12/2018 10:00	1,634	405938,228	0,819	17,242	10500,178	41,741
11/12/2018 11:00	1,658	391927,327	0,821	19,483	10168,894	39,997
11/12/2018 12:00	1,588	391017,527	0,833	18,349	10164,916	39,998
11/12/2018 13:00	1,586	391229,785	0,834	17,568	10138,411	39,999
11/12/2018 14:00	1,544	391773,163	0,843	17,979	10107,307	39,998
11/12/2018 15:00	1,479	400095,899	0,839	16,566	10353,764	41,434
11/12/2018 16:00	1,453	403998,813	0,838	15,804	10490,334	41,999
11/12/2018 17:00	1,451	403697,368	0,827	15,513	10504,508	41,997
11/12/2018 18:00	1,449	404773,535	0,826	15,275	10543,614	42
11/12/2018 19:00	1,423	406371,005	0,819	14,479	10577,961	42,002
11/12/2018 20:00	1,415	406709,715	0,796	14,209	10593,52	41,996
11/12/2018 21:00	1,472	407804,56	0,806	15,072	10586,724	41,999
11/12/2018 22:00	1,596	408517,352	0,805	15,778	10576,947	41,999
11/12/2018 23:00	1,71	409024,378	0,804	16,033	10564,069	42,001
12/12/2018 00:00	1,967	410484,707	0,801	15,904	10560,98	42,001
12/12/2018 01:00	1,871	408754,642	0,819	16,794	10570,382	42,002
12/12/2018 02:00	1,527	407957,941	0,846	18,028	10575,887	41,996
12/12/2018 03:00	1,523	408212,833	0,843	18,546	10567,143	41,998
12/12/2018 04:00	1,523	408623,243	0,854	19,09	10557,791	42,004
12/12/2018 05:00	1,602	409781,273	0,842	20,563	10552,59	42,001
12/12/2018 06:00	1,59	408849,209	0,79	18,883	10560,205	41,996
12/12/2018 07:00	1,432	433292,136	0,818	16,11	11275,699	45,954
12/12/2018 08:00	1,415	437551,378	3,181	15,916	11428,798	46,665
12/12/2018 09:00	1,439	433227,019	0,708	15,717	11304,387	46,128
12/12/2018 10:00	1,442	425962,194	0,79	15,993	11095,338	45,09
12/12/2018 11:00	1,486	434158,356	0,777	17,774	11346,979	46,351
12/12/2018 12:00	1,484	428684,76	0,798	17,646	11215,149	45,693
12/12/2018 13:00	1,491	421924,109	0,802	17,599	11059,287	44,945
12/12/2018 14:00	1,495	420702,79	0,8	17,577	10994,807	44,675
12/12/2018 15:00	1,489	420928,064	0,8	17,724	10958,224	44,524
12/12/2018 16:00	1,48	424041,682	0,798	17,785	11019,996	44,859
12/12/2018 17:00	1,472	429801,441	0,795	18,126	11161,693	45,591
12/12/2018 18:00	1,428	439411,95	0,783	17,997	11422,8	46,802
12/12/2018 19:00	1,411	441776,379	0,775	17,706	11491,803	47
12/12/2018 20:00	1,381	442016,455	0,813	16,969	11489,332	46,996
12/12/2018 21:00	1,338	442449,274	0,803	16,208	11496,259	47
12/12/2018 22:00	1,363	442402,021	0,808	16,223	11504,567	47,003
12/12/2018 23:00	1,499	436746,792	0,811	16,528	11323,751	45,964
13/12/2018 00:00	1,794	416893,076	0,839	18,142	10725,373	42,999
13/12/2018 01:00	1,541	417622,744	0,835	21,496	10738,498	42,998
13/12/2018 02:00	1,571	419035,044	0,828	21,339	10736,861	42,999
13/12/2018 03:00	1,626	419743,73	0,821	21,313	10734,983	43,002
13/12/2018 04:00	1,724	420347,033	0,83	21,053	10736,809	42,998
13/12/2018 05:00	1,906	421037,89	0,831	20,879	10737,523	43,004
13/12/2018 06:00	1,769	420570,595	0,814	21,208	10747,369	43,001
13/12/2018 07:00	1,639	419484,558	0,833	21,266	10751,036	43,003
13/12/2018 08:00	1,56	418725,649	1,262	21,803	10739,867	43
13/12/2018 09:00	1,546	417247,562	0,709	20,208	10724,398	43,004
13/12/2018 10:00	1,551	415994,398	0,811	18,416	10718,267	43,003
13/12/2018 11:00	1,513	414742,101	0,846	17,507	10721,694	43
13/12/2018 12:00	1,489	415684,964	0,854	16,525	10698,371	43,003
13/12/2018 13:00	1,395	415618,569	0,85	14,994	10672,945	43,002
13/12/2018 14:00	1,401	415698,938	0,865	14,806	10664,482	43,002
13/12/2018 15:00	1,39	415151,484	0,861	14,113	10996,083	42,999
13/12/2018 16:00	1,398	415392,434	0,862	14,143	11030,521	42,997
13/12/2018 17:00	1,395	416564,499	0,86	14,448	10938,934	43,003
13/12/2018 18:00	1,49	417359,326	0,863	15,694	10819,893	43,002
13/12/2018 19:00	2,043	418957,587	0,846	16,96	10811,364	43,003
13/12/2018 20:00	1,502	416146,976	0,854	19,969	10846,292	42,996
13/12/2018 21:00	1,52	417321,006	0,857	21,441	10851,255	42,999
13/12/2018 22:00	1,541	418025,697	0,864	21,642	10851,601	43,003
13/12/2018 23:00	1,564	418300,393	0,867	21,298	10850,324	43
14/12/2018 00:00	1,614	419596,427	0,85	21,396	10804,097	42,999
14/12/2018 01:00	1,675	420002,719	0,869	21,59	10769,423	43,002
14/12/2018 02:00	1,659	420296,607	0,868	21,504	10778,414	42,998
14/12/2018 03:00	1,787	421111,256	0,878	21,298	10789,158	42,998
14/12/2018 04:00	1,87	421540,566	0,871	21,19	10798,108	43,003
14/12/2018 05:00	1,824	421329,127	0,886	21,256	10788,869	42,999
14/12/2018 06:00	1,724	420576,797	0,871	21,586	10776,212	43,005
14/12/2018 07:00	1,585	418405,789	0,894	21,741	10771,349	42,995
14/12/2018 08:00	1,555	417110,51	2,132	20,574	10770,827	43,006
14/12/2018 09:00	1,573	415681,925	0,768	17,801	10766,725	42,998
14/12/2018 10:00	1,554	414758,709	0,863	16,881	10764,094	43,002
14/12/2018 11:00	19,821	393747,59	0,895	15,306	10017,925	39,118
14/12/2018 12:00	25,688	344431,865	0,94	13,014	8469,028	30,997
14/12/2018 13:00	10,923	378227,072	0,917	14,309	9556,734	36,905
14/12/2018 14:00	1,403	427192,16	0,866	15,39	11115,394	45,002
14/12/2018 15:00	1,383	426746,807	0,871	15,644	11096,39	44,953
14/12/2018 16:00	1,384	427268,646	0,874	15,738	11091,34	44,983
14/12/2018 17:00	1,386	427138,117	0,871	15,774	11075,546	44,986
14/12/2018 18:00	1,387	427070,38	0,86	15,653	11087,111	44,994
14/12/2018 19:00	1,389	426963,289	0,87	15,671	11091,239	45,002
14/12/2018 20:00	1,408	426513,833	0,804	15,653	11105,79	45
14/12/2018 21:00	1,439	427320,575	0,812	15,649	11124,788	44,998
14/12/2018 22:00	1,496	427561,991	0,818	15,569	11135,209	44,999
14/12/2018 23:00	1,448	428783,027	0,829	15,235	11134,817	45,002
15/12/2018 00:00	1,44	428657,972	0,818	15,089	11134,627	44,999
15/12/2018 01:00	1,508	429412,594	0,847	14,711	11139,059	44,999
15/12/2018 02:00	1,444	431047,018	0,843	14,593	11142,352	44,997
15/12/2018 03:00	1,523	431812,317	0,841	14,864	11117,674	45,002
15/12/2018 04:00	1,459	432101,532	0,85	15,41	11145,744	45,003
15/12/2018 05:00	1,595	432984,756	0,849	16,568	11171,568	45
15/12/2018 06:00	1,47	432275,244	0,828	15,6	11149,296	44,999
15/12/2018 07:00	1,467	430247,438	0,852	14,829	11119,833	45
15/12/2018 08:00	1,464	428153,823	3,976	15,633	11074,039	45,002

15/12/2018 09:00	1,468	427547,011	0,737	15,514	11065,967	45
15/12/2018 10:00	1,456	427045,038	0,81	15,301	11159,489	45
15/12/2018 11:00	1,42	426406,351	0,817	15,106	11313,683	44,99
15/12/2018 12:00	1,428	422228,197	0,816	15,336	11232,37	44,671
15/12/2018 13:00	1,427	414364,17	0,825	14,921	11158,074	43,776
15/12/2018 14:00	1,431	410644,039	0,824	14,905	11049,153	43,277
15/12/2018 15:00	1,447	407683,388	0,829	15,055	10846,038	42,771
15/12/2018 16:00	1,465	406180,469	0,83	15,425	10567,462	42,517
15/12/2018 17:00	1,464	408354	0,819	15,559	10568,628	42,738
15/12/2018 18:00	1,431	415979,44	0,821	15,737	10761,301	43,643
15/12/2018 19:00	1,405	424163,262	0,827	15,799	10975,77	44,634
15/12/2018 20:00	1,412	426946,067	0,792	15,745	11059,252	44,997
15/12/2018 21:00	1,413	427764,759	0,785	15,799	11073,193	45,003
15/12/2018 22:00	1,454	428765,295	0,794	15,792	11096,65	45
15/12/2018 23:00	1,52	428601,62	0,807	15,73	11115,938	45,002
16/12/2018 00:00	1,491	429263,528	0,797	15,282	11119,523	44,998
16/12/2018 01:00	1,63	430271,136	0,817	14,939	11137,728	45,003
16/12/2018 02:00	1,469	430429,33	0,815	14,78	11136,953	45,004
16/12/2018 03:00	1,494	431648,168	0,81	14,705	11136,242	45
16/12/2018 04:00	1,495	431437,06	0,822	14,757	11140,543	44,999
16/12/2018 05:00	1,498	432269,265	0,828	14,981	11135,917	44,998
16/12/2018 06:00	1,46	431320,781	0,793	14,869	11130,339	44,999
16/12/2018 07:00	1,459	428491,328	0,816	15,576	11121,612	45,002
16/12/2018 08:00	1,462	427321,291	0,824	15,616	11104,276	44,998
16/12/2018 09:00	1,454	426586,433	0,726	15,523	11084,257	44,996
16/12/2018 10:00	1,455	422139,394	0,79	15,666	10998,28	44,548
16/12/2018 11:00	1,462	416665,025	0,797	15,497	10874,56	43,797
16/12/2018 12:00	1,477	409456,751	0,8	15,342	10711,487	43,02
16/12/2018 13:00	1,461	403813,128	0,81	15,197	10580,043	42,42
16/12/2018 14:00	1,475	401408,633	0,814	15,097	10495,947	42,064
16/12/2018 15:00	1,481	400344,489	0,812	15,183	10420,398	41,782
16/12/2018 16:00	1,473	400900,661	0,817	15,14	10403,557	41,802
16/12/2018 17:00	1,465	404258,434	0,81	15,273	10481,724	42,251
16/12/2018 18:00	1,452	407648,921	0,812	15,42	10578,53	42,711
16/12/2018 19:00	1,421	417494,709	0,811	15,583	10820,136	43,858
16/12/2018 20:00	1,401	425834,884	0,783	15,67	11063,763	44,947
16/12/2018 21:00	1,404	426979,817	0,773	15,661	11084,493	44,996
16/12/2018 22:00	1,441	427162,931	0,787	15,616	11100,053	45
16/12/2018 23:00	1,491	427391,576	0,792	15,593	11120,439	45
17/12/2018 00:00	1,455	427592,232	0,789	15,632	11127,851	44,999
17/12/2018 01:00	1,446	427567,085	0,8	15,619	11125,733	44,995
17/12/2018 02:00	1,461	428056,695	0,811	15,319	11116,465	44,998
17/12/2018 03:00	15,501	378140,347	0,855	13,867	9497,915	36,5
17/12/2018 04:00	18,125	350283,559	0,9	13,079	8619,908	31,999
17/12/2018 05:00	20,319	350344,451	0,889	13,134	8616,557	32,006
17/12/2018 06:00	21,615	350272,681	0,875	13,194	8619,028	31,996
17/12/2018 07:00	21,664	343276,923	0,892	13,464	8421,685	31,086
17/12/2018 08:00	18,995	353014,927	0,89	14,6	8783,557	32,83
17/12/2018 09:00	7,115	382092,982	0,747	16,388	9695,995	37,738
17/12/2018 10:00	1,553	427895,602	0,781	17,474	11220,02	45,268
17/12/2018 11:00	1,584	426111,264	0,797	17,249	11195,837	45,04
17/12/2018 12:00	1,665	390259,117	0,821	16,088	10181,345	39,596
17/12/2018 13:00	6,046	378761,208	0,839	16,112	9803,625	37,872
17/12/2018 14:00	1,512	419892,315	0,803	17,087	11104,375	44,366
17/12/2018 15:00	1,506	419345,476	0,806	16,97	11103,844	44,254
17/12/2018 16:00	17,023	369060,069	0,843	15,919	9542,335	35,871
17/12/2018 17:00	19,014	338266,488	0,878	14,917	8561,004	31,089
17/12/2018 18:00	1,661	378412,165	0,828	18,853	10001,417	37,995
17/12/2018 19:00	1,654	379921,564	0,83	19,408	9914,589	38,001
17/12/2018 20:00	1,7	381554,907	0,822	18,764	9845,436	37,999
17/12/2018 21:00	1,802	382004,698	0,821	18,515	9864,894	37,998
17/12/2018 22:00	3,088	382629,3	0,823	17,52	10092,078	37,995
17/12/2018 23:00	4,857	383365,137	0,833	17,055	10133,893	38
18/12/2018 00:00	5,332	384031,835	0,818	17,117	10120,033	38,001
18/12/2018 01:00	4,256	383913,723	0,847	17,379	10044,693	37,999
18/12/2018 02:00	6,154	381133,297	0,849	17,172	9822,068	37,408
18/12/2018 03:00	96,9	35630,416	66,254	4,678	1796,708	4,07
18/12/2018 04:00		0	0	0,124	0	0
18/12/2018 05:00		0	0	0	0	0
18/12/2018 06:00		0	0	0	0	0
18/12/2018 07:00		0	0	0	0	0
18/12/2018 08:00		0	0	0	0	0
18/12/2018 09:00		0	0	0	0	0
18/12/2018 10:00		0	0	0	0	0
18/12/2018 11:00		0	0	0	0	0
18/12/2018 12:00		0	0	0	0	0
18/12/2018 13:00		0	0	0	0	0
18/12/2018 14:00		0	0	0	0	0
18/12/2018 15:00		0	0	0	0	0
18/12/2018 16:00		0	0	0	0	0
18/12/2018 17:00		0	0	0	0	0
18/12/2018 18:00		0	0	0	0	0
18/12/2018 19:00		0	0	0	0	0
18/12/2018 20:00		0	0	0	0	0
18/12/2018 21:00		0	0	0,024	0	0
18/12/2018 22:00		0	0	0,02	0	0
18/12/2018 23:00		0	0	0,02	0	0
19/12/2018 00:00		0	0	0,017	0	0
19/12/2018 01:00		0	0	0,019	0	0
19/12/2018 02:00		0	0	1,099	0	0
19/12/2018 03:00	114,875	1577,723	0,711	5,293	0	0
19/12/2018 04:00	57,847	103516,537	0,101	11,836	0	0
19/12/2018 05:00	29,409	358287,868	0,268	11,957	0	0
19/12/2018 06:00	9,199	359969,757	0,412	12,085	0	0
19/12/2018 07:00	2,339	358443,289	0,347	13,21	0	0
19/12/2018 08:00	1,875	357731,474	0,458	13,557	0	0
19/12/2018 09:00		356057,207	0,324	10,374	0	0
19/12/2018 10:00		354345,432	0,554	10,374	0	0
19/12/2018 11:00		353716,062	4,133	10,374	0	0
19/12/2018 12:00		355277,516	31,795	10,374	0	0
19/12/2018 13:00		354646,798	37,94	10,374	0	0
19/12/2018 14:00	2,842	354901,47	36,588	18,37	0	0

19/12/2018 15:00	2,76	356785,241	2,754	18,78	0	0
19/12/2018 16:00	1,562	418838,715	0,612	15,671	0	0
19/12/2018 17:00	1,511	421777,392	0,367	15,614	0	0
19/12/2018 18:00	1,464	375865,971	0,256	15,422	0	0
19/12/2018 19:00	1,503	427661,611	0,2	15,968	0	0
19/12/2018 20:00	1,507	435265,432	0,202	16,439	0	0
19/12/2018 21:00	1,514	438133,351	0,232	16,4	0	0
19/12/2018 22:00	1,482	441585,887	0,279	16,052	0	0
19/12/2018 23:00	1,504	441900,482	0,221	16,163	0	0
20/12/2018 00:00	1,528	442170,284	0,262	16,181	0	0
20/12/2018 01:00	10,891	397066,509	0,264	15,803	0	0
20/12/2018 02:00	1,663	422331,279	0,256	17,955	0	0
20/12/2018 03:00	1,653	422581,733	0,211	18,151	0	0
20/12/2018 04:00	1,889	424613,876	0,225	18,479	0	0
20/12/2018 05:00	1,57	463012,983	0,266	18,184	0	0
20/12/2018 06:00	1,585	462665,026	0,37	18,262	0	0
20/12/2018 07:00	1,542	461491,695	0,418	18,511	0	0
20/12/2018 08:00	1,56	453856,326	0,34	18,665	0	0
20/12/2018 09:00	2,165	433048,902	0,324	17,341	0	0
20/12/2018 10:00	1,979	357560,081	0,42	13,66	0	0
20/12/2018 11:00	1,747	349711,603	3,625	14,696	0	0
20/12/2018 12:00	1,836	352579,972	33,631	16,18	0	0
20/12/2018 13:00	2,633	354789,641	51,11	20,618	0	0
20/12/2018 14:00	2,389	354119,802	23,882	20,538	4282,684	16,412
20/12/2018 15:00	2,154	354888,543	0,852	20,975	8937,7	34,002
20/12/2018 16:00	1,824	355134,245	0,734	18,163	9883,18	39,053
20/12/2018 17:00	1,544	226095,284	0,314	15,972	10627,965	42,985
20/12/2018 18:00	1,586	314069,865	0,453	15,955	10544,371	42,214
20/12/2018 19:00	18,888	228629,612	0,137	14,225	8280,651	30,033
20/12/2018 20:00	30,015	217014,298	0,107	13,931	8259,636	30,001
20/12/2018 21:00	43,603	238301,19	0,099	14,101	8259,894	29,996
20/12/2018 22:00	35,995	288952,72	0,456	13,755	8401,17	30,813
20/12/2018 23:00	17,692	348236,073	0,858	13,193	8661,073	32
21/12/2018 00:00	24,849	349110,856	0,843	13,148	8662,229	32
21/12/2018 01:00	27,956	349615,935	0,867	13,21	8665,824	31,997
21/12/2018 02:00	36,382	350918,983	0,871	13,316	8658,954	31,999
21/12/2018 03:00	37,876	351284,341	0,872	13,343	8662,863	31,997
21/12/2018 04:00	33,603	350889,28	0,866	13,472	8661,484	31,996
21/12/2018 05:00	35,198	351182,617	0,87	13,616	8656,081	32,001
21/12/2018 06:00	19,694	355465,068	0,845	13,904	8901,589	33,278
21/12/2018 07:00	1,992	363998,769	0,844	13,664	9238,436	35,001
21/12/2018 08:00	1,778	362834,537	0,833	14,154	9249,672	35
21/12/2018 09:00		358393,625	0,778	16,501	9250,987	35,003
21/12/2018 10:00	7,403	360357,612	5,231	13,397	9220,108	34,997
21/12/2018 11:00	13,317	356246,217	15,698	13,397	8925,97	33,806
21/12/2018 12:00	9,489	351024,319	0,816	18,815	8766,927	33
21/12/2018 13:00	4,966	348483,338	0,816	19,639	8748,037	33,001
21/12/2018 14:00	3,097	347962,143	0,817	20,379	8740,978	33,002
21/12/2018 15:00	11,042	329538,797	0,837	17,975	8159,312	29,703
21/12/2018 16:00	1,758	329421,132	0,824	14,982	8196,901	30,006
21/12/2018 17:00	2,539	333927,18	0,817	14,798	8270,273	30,411
21/12/2018 18:00	13,914	353666,714	0,833	18,611	8741,948	33,001
21/12/2018 19:00	2,63	351231,245	0,811	14,37	8802,644	33,001
21/12/2018 20:00	2,104	352432,41	0,82	13,332	8837,07	33,007
21/12/2018 21:00	3,209	352798,321	0,832	12,893	8843,1	33,001
21/12/2018 22:00	4,808	353361,474	0,835	12,809	8848,817	32,997
21/12/2018 23:00	6,434	353766,786	0,855	12,786	8853,705	33
22/12/2018 00:00	7,945	353802,093	0,862	12,74	8857,158	32,995
22/12/2018 01:00	9,46	354086,849	0,88	12,758	8856,47	32,999
22/12/2018 02:00	12,854	354916,779	0,879	12,727	8857,077	32,999
22/12/2018 03:00	16,73	355191,004	0,861	12,723	8851,611	33,001
22/12/2018 04:00	18,445	355661,949	0,865	12,62	8860,875	32,995
22/12/2018 05:00	27,317	355758,565	0,878	12,257	8889,027	33,005
22/12/2018 06:00	37,422	356851,692	0,833	12,037	8923,674	33
22/12/2018 07:00	41,695	355740,105	0,852	11,366	9098,754	32,999
22/12/2018 08:00	19,29	353429,021	0,866	11,55	9160,746	32,999
22/12/2018 09:00	8,16	352540,367	0,701	11,579	9155,695	33
22/12/2018 10:00	6,82	351885,566	0,807	11,664	9156,725	33,005
22/12/2018 11:00	3,385	351130,595	0,827	12,43	9142,402	33
22/12/2018 12:00	2,405	349250,893	0,834	12,68	9146,433	33,001
22/12/2018 13:00	1,925	347787,367	0,83	12,797	9140,839	33
22/12/2018 14:00	1,782	348128,312	0,831	12,939	9112,787	32,998
22/12/2018 15:00	1,74	348625,415	0,832	12,997	9114,153	33,003
22/12/2018 16:00	1,745	349047,761	0,836	12,975	9103,323	32,997
22/12/2018 17:00	1,9	349449,939	0,841	12,9	9065,943	33
22/12/2018 18:00	2,664	351351,415	0,83	12,571	9085,8	32,998
22/12/2018 19:00	5,008	351363,856	0,833	12,059	9124,906	33,002
22/12/2018 20:00	27,122	346149,845	0,847	11,731	8952,593	31,798
22/12/2018 21:00	44,586	342606,202	0,854	11,885	8776,708	31
22/12/2018 22:00	35,483	347806,846	0,861	11,846	8925,031	31,883
22/12/2018 23:00	41,346	348966,219	0,874	11,997	8926,66	32
23/12/2018 00:00	31,905	354118,727	0,865	11,749	9040,586	32,725
23/12/2018 01:00	28,57	354012,214	0,864	11,505	9120,421	32,997
23/12/2018 02:00	34,587	354866,965	0,863	11,556	9122,502	32,999
23/12/2018 03:00	39,844	355300,043	0,878	11,47	9127,402	32,996
23/12/2018 04:00	40,973	355162,857	0,876	11,323	9143,972	33
23/12/2018 05:00	41,621	355532,268	0,87	11,35	9163,458	33,001
23/12/2018 06:00	35,386	354832,181	0,857	11,441	9149,634	33
23/12/2018 07:00	19,339	353575,5	0,877	11,272	9161,539	33,003
23/12/2018 08:00	11,976	352344,626	0,895	11,285	9159,848	33,005
23/12/2018 09:00	4,576	350867,761	0,715	12,053	9130,496	32,998
23/12/2018 10:00	2,352	349977,632	0,843	12,576	9118,137	32,995
23/12/2018 11:00	1,775	348540,059	0,831	12,936	9116,668	32,999
23/12/2018 12:00	1,632	346517,081	0,84	13,611	9122,759	32,999
23/12/2018 13:00	1,638	343794,909	0,837	14,521	9119,285	32,999
23/12/2018 14:00	4,766	345746,62	0,846	16,617	9090,603	33,001
23/12/2018 15:00	6,21	347513,258	0,857	18,606	9061,197	33,004
23/12/2018 16:00	5,779	346046,667	0,849	18,556	9034,794	32,747
23/12/2018 17:00	6,062	348157,086	0,855	18,182	9085,253	33,001
23/12/2018 18:00	12,3	350799,666	0,851	16,257	9105,979	33,004
23/12/2018 19:00	24,741	352892,528	0,85	15,722	9140,225	33
23/12/2018 20:00	28,431	347323,067	0,826	14,884	9059,473	32,427

23/12/2018 21:00	33,493	334935,995	0,88	12,213	8622,958	30,001
23/12/2018 22:00	40,821	335558,702	0,883	12,173	8602,978	30,002
23/12/2018 23:00	18,042	346099,99	0,87	11,748	8958,104	31,856
24/12/2018 00:00	16,241	346148,635	0,885	11,693	8971,841	32,001
24/12/2018 01:00	16,273	346150,413	0,919	11,701	8968,308	31,997
24/12/2018 02:00	21,8	347043,401	0,905	11,72	8956,122	31,997
24/12/2018 03:00	28,083	347732,751	0,892	11,723	8955,187	32,001
24/12/2018 04:00	23,61	347283,248	0,906	11,773	8956,628	32,003
24/12/2018 05:00	27,715	348138,552	0,904	11,788	8948,766	31,999
24/12/2018 06:00	23,968	347615,496	0,884	11,862	8946,781	32,001
24/12/2018 07:00	12,799	347165,918	0,907	11,992	8941,818	32
24/12/2018 08:00	6,337	345531,996	0,93	12,112	8940,795	32
24/12/2018 09:00	2,761	343623,864	0,684	12,879	8958,129	32,002
24/12/2018 10:00	2,056	342508,083	0,772	13,392	8950,301	32
24/12/2018 11:00	1,788	341321,574	0,767	13,818	8944,132	32
24/12/2018 12:00	1,684	339350,74	0,763	14,216	8949,824	32,003
24/12/2018 13:00	1,673	337319,694	0,772	14,805	8956,023	32
24/12/2018 14:00	1,686	337218,09	0,766	14,982	8940,566	31,999
24/12/2018 15:00	1,636	338629,907	0,778	14,564	8920,558	32,004
24/12/2018 16:00	1,634	339220,495	0,765	14,529	8909,063	32,003
24/12/2018 17:00	1,646	340587,669	0,786	14,377	8907,582	32,005
24/12/2018 18:00	1,721	342043,365	0,775	13,861	8931,578	31,998
24/12/2018 19:00	2,382	344603,285	0,773	13,018	8953,055	31,994
24/12/2018 20:00	4,16	345785,184	0,778	12,518	8951,266	32,002
24/12/2018 21:00	6,882	346289,849	0,788	12,192	8923,203	31,999
24/12/2018 22:00	15,61	348184,461	0,773	12,067	8931,38	32
24/12/2018 23:00	15,62	348069,343	0,779	12,413	8924,498	32,002
25/12/2018 00:00	15,45	348099,828	0,786	12,27	8927,329	32
25/12/2018 01:00	31,784	349478,794	0,793	11,876	8959,295	31,998
25/12/2018 02:00	33,573	349839,546	0,774	11,734	8995,767	31,999
25/12/2018 03:00	36,602	350145,908	0,79	11,747	9016,996	32
25/12/2018 04:00	36,838	349972,781	0,793	11,783	9033,257	32,002
25/12/2018 05:00	42,752	350467,77	0,805	11,726	9038,675	31,996
25/12/2018 06:00	38,096	349789,165	0,791	11,721	9025,44	31,996
25/12/2018 07:00	16,312	347295,15	0,815	11,955	9003,128	31,995
25/12/2018 08:00	7,872	346337,329	0,842	12,167	8972,771	31,996
25/12/2018 09:00	3,369	344660,416	0,679	12,859	8932,711	31,995
25/12/2018 10:00	1,986	342560,48	0,794	13,639	8883,172	31,998
25/12/2018 11:00	1,866	342650,513	0,786	13,46	8865,478	32,001
25/12/2018 12:00	1,746	341016,274	0,785	13,736	8848,67	31,997
25/12/2018 13:00	1,664	338792,505	0,792	14,128	8821,301	32
25/12/2018 14:00	1,625	339307,414	0,794	14,215	8801,947	32,003
25/12/2018 15:00	1,636	339563,175	0,785	14,498	8796,477	32,002
25/12/2018 16:00	1,629	339982,08	0,783	14,378	8807,094	31,999
25/12/2018 17:00	1,652	341278,237	0,791	13,903	8808,53	31,999
25/12/2018 18:00	1,733	342679,519	0,789	13,617	8839,876	31,999
25/12/2018 19:00	3,196	345697,275	0,79	12,547	8894,283	32
25/12/2018 20:00	7,847	346646,456	0,797	11,985	8914,225	31,997
25/12/2018 21:00	12,07	346868,536	0,804	11,874	8910,26	32
25/12/2018 22:00	18,217	347739,994	0,807	11,833	8911,687	32
25/12/2018 23:00	23,116	348296,007	0,805	11,823	8919,347	31,998
26/12/2018 00:00	24,317	348165,407	0,805	11,877	8917,657	32
26/12/2018 01:00	35,655	349548,648	0,827	11,782	8896,727	31,999
26/12/2018 02:00	40,27	350050,84	0,843	11,691	8904,412	32,005
26/12/2018 03:00	44,986	351372,995	0,838	11,595	8923,49	32,126
26/12/2018 04:00	24,806	355530,357	0,823	11,2	9110,445	33
26/12/2018 05:00	26,66	354565,798	0,814	11,223	9115,098	33,002
26/12/2018 06:00	93,299	28347,779	8,664	2,942	1754,721	3,226
26/12/2018 07:00		0	0	0,115	0	0
26/12/2018 08:00		0	0	0,065	0	0
26/12/2018 09:00		0	0	0,044	0	0
26/12/2018 10:00		0	0	0,032	0	0
26/12/2018 11:00		0	0	0,027	0	0
26/12/2018 12:00		0	0	0,022	0	0
26/12/2018 13:00		0	0	0,012	0	0
26/12/2018 14:00		0	0	0,014	0	0
26/12/2018 15:00		0	0	0,021	0	0
26/12/2018 16:00		0	0	0,018	328,245	0
26/12/2018 17:00		0	0	0,122	348,971	0
26/12/2018 18:00		0	0	0,173	0	0
26/12/2018 19:00		0	0	0,027	0	0
26/12/2018 20:00	34,326	0	14,465	1,78	1160,712	0
26/12/2018 21:00		0	0	0,271	0	0
26/12/2018 22:00		0	0	0,022	0	0
26/12/2018 23:00		0	0	0,01	0	0
27/12/2018 00:00		0	0	0,006	0	0
27/12/2018 01:00		0	0	0,004	0	0
27/12/2018 02:00		0	0	0,005	0	0
27/12/2018 03:00		0	0	0,007	0	0
27/12/2018 04:00		0	0	0,015	0	0
27/12/2018 05:00		0	0	0,029	0	0
27/12/2018 06:00		0	0	0,021	0	0
27/12/2018 07:00		0	0	0,014	0	0
27/12/2018 08:00		0	0	0,019	0	0
27/12/2018 09:00		0	0	0,02	0	0
27/12/2018 10:00		0	0	0,022	0	0
27/12/2018 11:00		0	0	0,013	0	0
27/12/2018 12:00		0	0	0,005	0	0
27/12/2018 13:00		0	0	0,002	0	0
27/12/2018 14:00		0	0	0,001	0	0
27/12/2018 15:00		0	0	0,003	0	0
27/12/2018 16:00		0	0	0,01	162,406	0
27/12/2018 17:00	49,179	0	7,714	3,133	2459,451	0
27/12/2018 18:00	204,167	32014,462	1,406	9,76	6168,522	18,692
27/12/2018 19:00	179,381	241504,715	0,626	13,533	7619,39	26,362
27/12/2018 20:00	5,211	350001,812	0,896	12,666	8692,277	32,001
27/12/2018 21:00	8,24	350225,538	0,888	12,593	8716,519	32,001
27/12/2018 22:00	12,22	350882,971	0,893	12,421	8743,352	32,002
27/12/2018 23:00	15,946	351461,595	0,889	12,397	8767,971	32,002
28/12/2018 00:00	22,542	351697,175	0,881	12,412	8779,979	31,997
28/12/2018 01:00	26,801	352308,025	0,885	12,477	8788,83	32,006
28/12/2018 02:00	32,128	353052,161	0,897	12,299	8785,811	32

28/12/2018 03:00	36,034	353511,539	0,911	12,327	8768,183	32,004
28/12/2018 04:00	28,459	357346,792	0,905	12,064	8856,461	32,71
28/12/2018 05:00	19,246	358790,506	0,884	11,945	8902,653	32,997
28/12/2018 06:00	14,888	358363,855	0,865	12,095	8890,554	33
28/12/2018 07:00	5,726	356066,044	0,896	12,453	8869,311	33
28/12/2018 08:00	2,905	354485,482	0,922	12,812	8850,958	33,002
28/12/2018 09:00	1,958	353574,688	0,709	13,289	8839,503	32,997
28/12/2018 10:00	1,733	352013,722	0,808	13,599	8839,432	32,999
28/12/2018 11:00	1,637	351529,693	0,804	13,784	8808,724	33
28/12/2018 12:00	1,616	348931,44	0,813	14,172	8788,422	32,999
28/12/2018 13:00	1,639	347387,75	0,811	14,704	8790,831	33
28/12/2018 14:00	1,68	346719,116	0,805	15,419	8869,842	32,998
28/12/2018 15:00	5,597	351122,705	0,823	17,926	8865,988	32,999
28/12/2018 16:00	6,651	352145,954	0,823	18,103	8856,204	32,999
28/12/2018 17:00	10,313	353203,205	0,815	17,4	8844,238	33
28/12/2018 18:00	20,22	355511,26	0,809	16,85	8855,89	33
28/12/2018 19:00	7,723	353320,077	0,805	14,201	8964,651	32,996
28/12/2018 20:00	2,332	353724,228	0,812	13,197	8979,516	32,998
28/12/2018 21:00	3,21	354946,674	0,809	12,827	8949,932	33
28/12/2018 22:00	5,422	355294,768	0,811	12,428	8987,524	32,999
28/12/2018 23:00	7,097	355424,876	0,815	12,257	8996,796	32,999
29/12/2018 00:00	9,193	355572,312	0,818	12,152	8986,975	32,996
29/12/2018 01:00	12,107	355991,393	0,865	12,045	8995,2	33,002
29/12/2018 02:00	14,138	356571,212	0,879	12,079	8979,863	33
29/12/2018 03:00	16,148	357288,639	0,877	12,097	8956,348	33,001
29/12/2018 04:00	17,209	357715,3	0,876	12,112	8956,243	33,001
29/12/2018 05:00	21,112	357695,151	0,887	11,99	9007,496	32,999
29/12/2018 06:00	17,776	357270,411	0,845	12,231	8924,56	32,998
29/12/2018 07:00	6,69	355614,668	0,874	12,626	8807,525	32,999
29/12/2018 08:00	2,915	354330,395	0,898	12,892	8786,555	32,996
29/12/2018 09:00	2,053	353955,395	0,734	13,232	8768,313	32,997
29/12/2018 10:00	1,814	353434,234	0,874	13,52	8759,099	32,998
29/12/2018 11:00	1,664	352920,958	0,871	13,837	8763,171	33
29/12/2018 12:00	1,611	351235,745	0,867	14,09	8774,055	33
29/12/2018 13:00	1,581	349754,373	0,872	14,585	8784,073	33
29/12/2018 14:00	1,68	361329,458	0,877	15,793	9100,671	34,787
29/12/2018 15:00	1,396	425731,648	0,833	17,381	11036,7	44,804
29/12/2018 16:00	1,482	403708,431	0,842	17,508	10450,871	41,426
29/12/2018 17:00	1,672	358574,449	0,862	16,83	9077,8	34,503
29/12/2018 18:00	1,634	365783,453	0,857	16,616	9283,621	35,564
29/12/2018 19:00	1,605	372505,037	0,851	16,742	9515,606	36,667
29/12/2018 20:00	1,632	373913,287	0,852	16,744	9607,469	36,943
29/12/2018 21:00	1,704	376413,061	0,886	16,608	9655,596	37,293
29/12/2018 22:00	1,64	380959,483	0,892	16,651	9784,501	37,923
29/12/2018 23:00	1,699	382007,661	0,897	16,697	9798,386	37,999
30/12/2018 00:00	1,799	381748,894	0,874	16,559	9811,551	38,001
30/12/2018 01:00	1,663	382657,16	0,904	16,359	9814,1	38,002
30/12/2018 02:00	1,834	383957,233	0,907	15,839	9842,661	37,999
30/12/2018 03:00	1,774	383926,299	0,891	15,69	9856,088	38,001
30/12/2018 04:00	1,811	384469,243	0,874	15,572	9857,831	37,999
30/12/2018 05:00	2,052	384617,9	0,883	15,558	9858,054	38
30/12/2018 06:00	1,775	384435,443	0,848	15,862	9860,589	37,999
30/12/2018 07:00	1,608	382634,988	0,882	16,682	9856,929	37,998
30/12/2018 08:00	12,11	359736,483	0,901	15,84	9161,655	34,225
30/12/2018 09:00	27,174	326642,196	0,614	13,583	8214,384	29,821
30/12/2018 10:00	15,746	338081,38	0,852	13,629	8239,863	30,002
30/12/2018 11:00	9,272	337249,137	0,862	13,612	8226,258	30,001
30/12/2018 12:00	5,459	334612,51	0,854	13,798	8199,476	30,003
30/12/2018 13:00	3,204	332202,459	0,866	13,909	8181,765	29,999
30/12/2018 14:00	2,049	331766,578	0,876	14,288	8174,013	30,002
30/12/2018 15:00	1,569	377215,413	0,839	17,48	9654,937	37,922
30/12/2018 16:00	1,566	376768,28	0,837	17,226	9612,111	37,778
30/12/2018 17:00	1,561	376445,504	0,83	17,192	9591,732	37,753
30/12/2018 18:00	1,544	379743,574	0,819	17,147	9632,142	37,998
30/12/2018 19:00	1,563	380707,654	0,814	18,444	9687,672	37,997
30/12/2018 20:00	1,591	381327,966	0,816	19,464	9745,253	37,997
30/12/2018 21:00	1,625	382386,916	0,827	19,412	9765,29	37,999
30/12/2018 22:00	1,696	383756,63	0,827	18,735	9778,104	38,002
30/12/2018 23:00	1,695	384848,164	0,845	18,506	9777,683	38,003
31/12/2018 00:00	1,985	384018,015	0,847	17,981	9773,423	37,998
31/12/2018 01:00	2,036	385062,539	0,864	17,691	9771,131	38,001
31/12/2018 02:00	2,402	385672,437	0,859	17,691	9776,667	37,996
31/12/2018 03:00	2,418	385613,535	0,875	17,356	9778,602	37,997
31/12/2018 04:00	4,886	386569,552	0,88	17,356	9778,452	37,997
31/12/2018 05:00	5,442	387307,559	0,869	17,693	9787,901	38,003
31/12/2018 06:00	3,646	386350,528	0,836	18,733	9796,081	37,996
31/12/2018 07:00	1,822	384239,414	0,877	19,357	9773,498	38
31/12/2018 08:00	1,628	382540,418	0,896	19,575	9759,549	38,003
31/12/2018 09:00	1,656	380586,94	0,672	18,708	9742,004	37,998
31/12/2018 10:00	1,633	379555,715	0,766	18,708	9739	38
31/12/2018 11:00	1,606	379506,964	0,76	18,03	9734,943	37,998
31/12/2018 12:00	7,877	351772,463	0,8	16,18	8850,777	33,243
31/12/2018 13:00	43,841	314307,35	0,836	16,092	7554,946	26,654
31/12/2018 14:00	49,026	311590,328	0,839	17,007	7435,517	26,156
31/12/2018 15:00	18,327	314464,649	0,833	16,817	7561,683	26,998
31/12/2018 16:00	54,922	35663,117	12,925	6,373	3319,976	8,918
31/12/2018 17:00		0	0,673	0,169	0	0
31/12/2018 18:00		0	0,688	0,066	0	0
31/12/2018 19:00		0	0,687	0,049	0	0
31/12/2018 20:00		0	0,681	0,042	0	0
31/12/2018 21:00		0	0,707	0,035	0	0
31/12/2018 22:00		0	0,695	0,03	0	0
31/12/2018 23:00		0	0,698	0,031	0	0